

SwitchBot Curtain

User Manual (Rod)

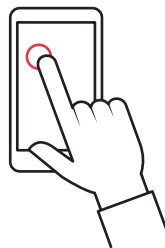
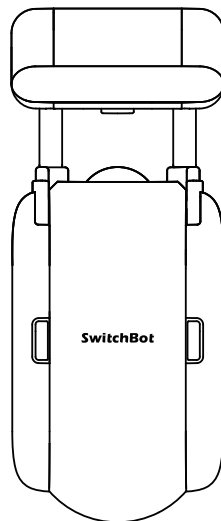

www.switch-bot.com

Contents

1. In the Box
2. Device Instruction
3. Preparation
4. Installation
5. Control
6. Settings
7. Charging, Firmware and Factory Reset
8. Specification
9. Return and Refund Policy
10. Contact and Support

Want to see how it's done?

Go to support.switch-bot.com for
installation videos and additional tips.

In the Box

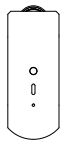

Main Body

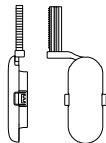

Hook Pair (Rod)

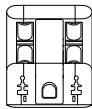

Top Lid (Rod)

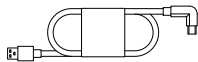

Type-C Cable

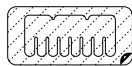

Rod Connector



Plastic Strip

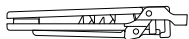

Clip

Device Instruction

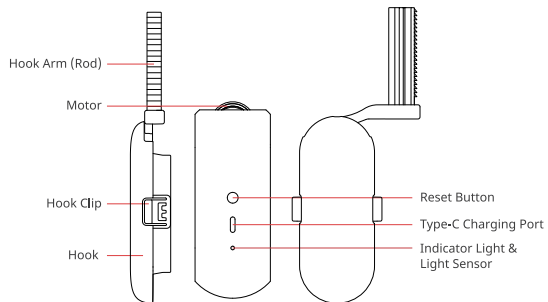
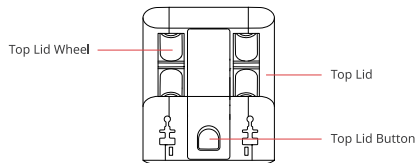

Preparation

- A smartphone or tablet with Bluetooth 4.2 or above
- Download the SwitchBot app
- Create a SwitchBot account and sign in
- Charge Curtain for about 4 hours
- (Optional) If you intend to use the Cloud Service feature, you need to set a SwitchBot Hub Mini (sold separately) up and connect your phone to the internet



Installation

Check your curtain rail

Before you get started with the installation procedure, we would like to remind you that the supported measurements for rod-type curtains are as follows,



Diameter

15.0mm - 40.0mm

In case your curtain rail does not work well with SwitchBot Curtain (Rod), please do not hesitate to seek for assistance at support@wondertechlabs.com

Step 1: Add Curtain in the app

Create a SwitchBot account and sign in from the app's Profile page. Then add Curtain to your account. Learn more at support.switch-bot.com/hc/en-us/articles/360060778713

Step 2: Install on Your Curtain Track

Retrofitting is simple with SwitchBot Curtain. It only takes a few seconds to make your existing curtains smart. It is straightforward and intuitive with our app instruction.

Adjust The Parts

When the Top Lid is connected to the Hook Arms, press down and hold the Button and slide the Top Lid up to the top position of the Hook Arms.

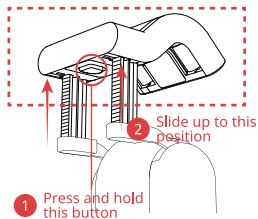

Important Tips on Telescopic Extendable Rod

Install Curtain on this end



If you are using an extendable curtain rod, Curtain may not move smoothly or even get stuck at the joining point of the rod during calibration.

Before you move on, please make sure you draw your curtain to the thicker end of the rod. And you must install Curtain on the thicker end of the rod as well.

Ring Top Curtains

Close the curtain. Then place the Curtain onto the rod between the first and the second ring behind the panel.

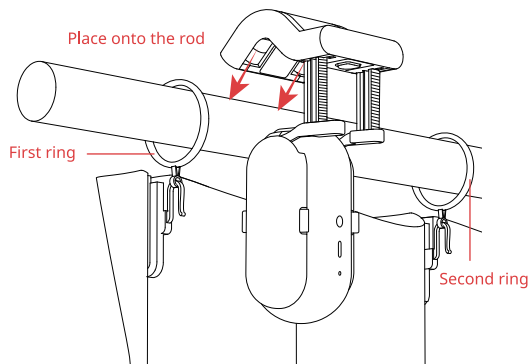

Backside of the curtain panel

Compress the space between the Top Lid and the Motor using both of your hands until Curtain is firmly attached. (Warning: over-compressing may break the Hook.)

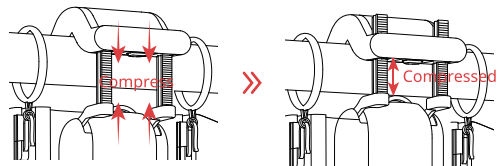

Installation complete. The Curtain should be hidden behind the panel.

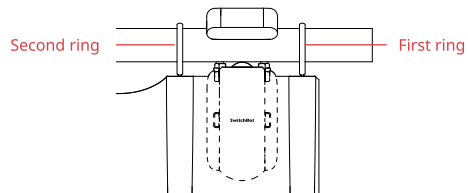

Grommet Curtains

Close the curtain. Then place the Curtain onto the rod between the first and the second grommet behind the panel.

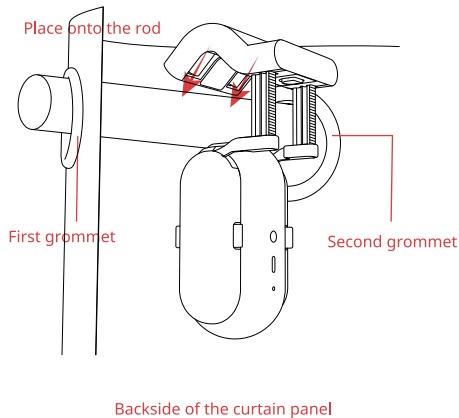

Compress the space between the Top Lid and the Motor using both of your hands until Curtain is firmly attached. (Warning: over-compressing may break the Hook.)

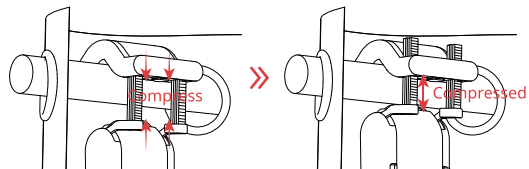

Installation complete. The Curtain should be hidden behind the panel.

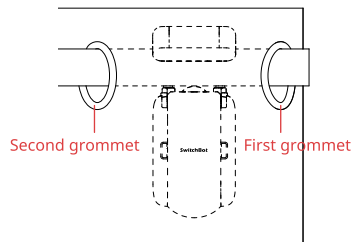

Tab Top Curtains

Grab the Clips provided in the box.

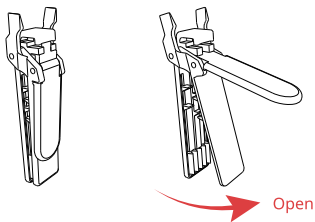

Attach a Clip on the first tab.

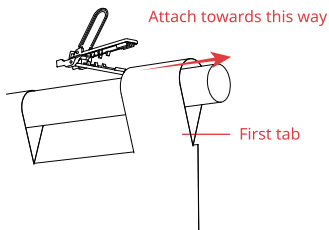

Attach Clips on every other tab.

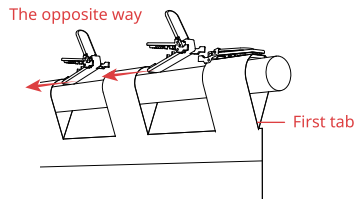

All other Clips should be attached the opposite way against the first Clip. Make sure all Clips are sitting on the top of the rod and are aligned with each other. From the second Clip, the tail of one Clip should be able to touch the head of the next Clip.

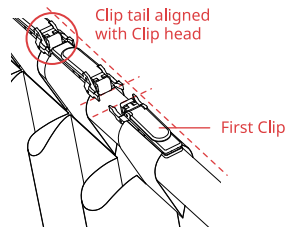

Place the Curtain onto the rod between the first and the second tab behind the panel.

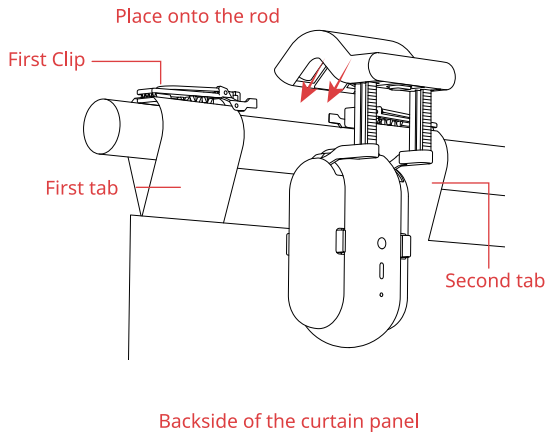

Compress the space between the Top Lid and the Motor using both of your hands until Curtain is firmly attached. (Warning: over-compressing may break the Hook.)

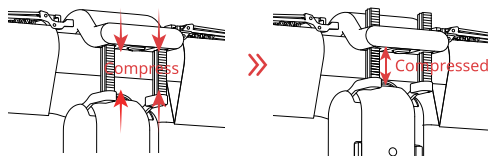

Installation complete. The Curtain should be hidden behind the panel.

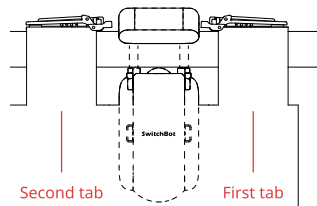

Back Tab Curtains

Grab the Clips provided in the box.

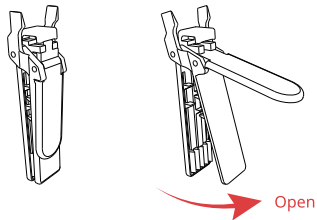

Attach a Clip on the first tab.

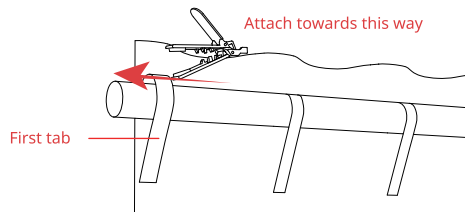

Attach Clips on every other tab.

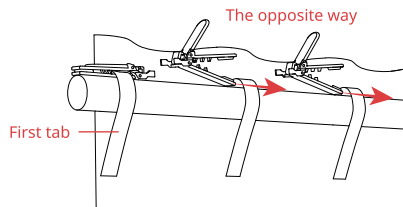

All other Clips should be attached the opposite way against the first Clip. Make sure all Clips are sitting on the top of the rod and are aligned with each other. From the second Clip, the tail of one Clip should be able to touch the head of the next Clip.

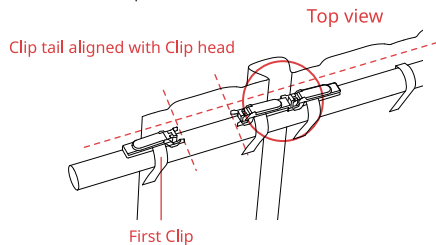

Place the Curtain onto the rod between the first and the second tab behind the panel.

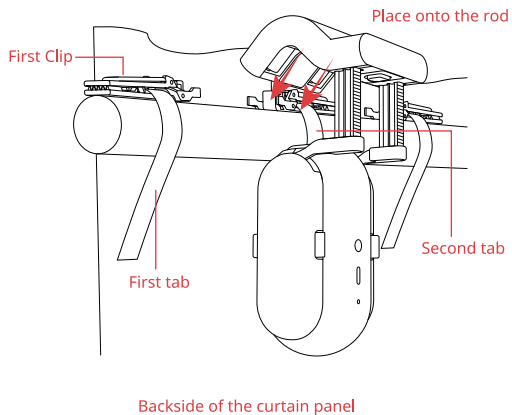

Compress the space between the Top Lid and the Motor using both of your hands until Curtain is firmly attached. (Warning: over-compressing may break the Hook.)

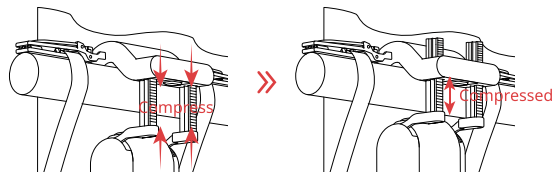

Installation complete. The Curtain should be hidden behind the panel.

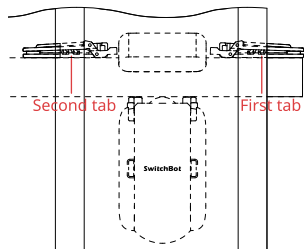

Grommet Curtains (Alternative)

This is an alternative method for Grommet Curtains when regular method does not work well. It requires more Clips and a special plastic Strip which can be purchased from us.

Close the curtain and make sure the distances between each fold line are approximately equal.

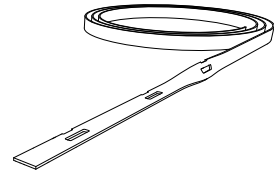
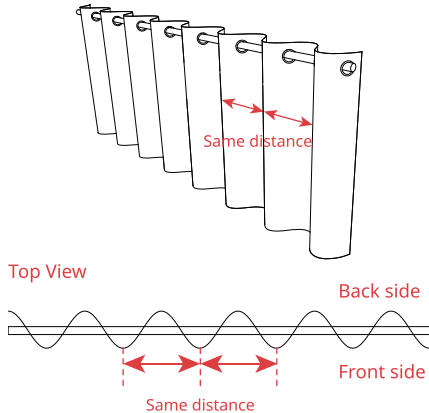

Straighten the Strip and align the first hole with one outer fold line. Count the number of holes between two outer fold lines and take note of this number.

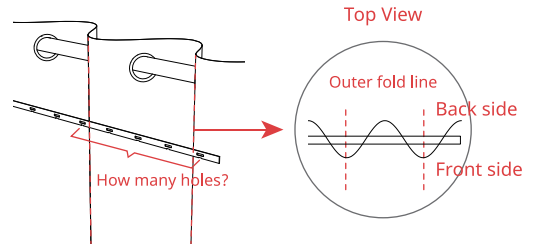

You need to determine how many Clips you need. Count the number of inner fold lines on the curtain panel. You need one Clip on each inner fold line.

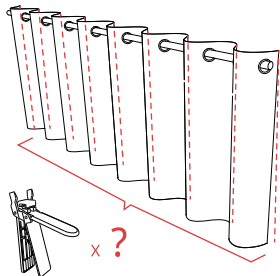

Top View

Inner fold line

Back side

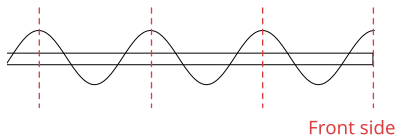

Grab the Clips provided in the box.

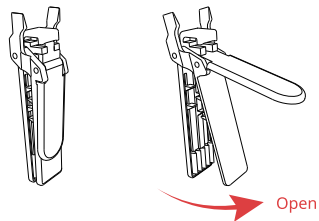

Attach a Clip to the end of the Strip. Insert the gap on the Strip into the Clip head and flip it over.

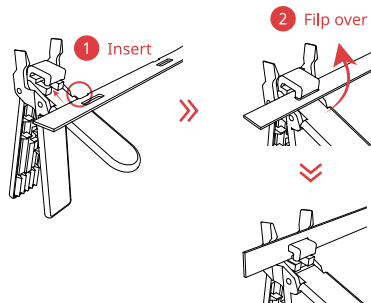

In previous steps, you have counted the number of holes between two outer fold lines. Use this number to determine the next position on the Strip that you are to attach a Clip. Attach all the Clips on the Strip.

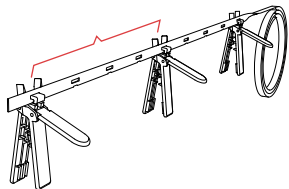
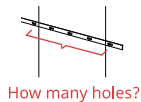

Install one Clip onto every inner fold line of the curtain panel. Keep the Strip straightened when you install the Clips.

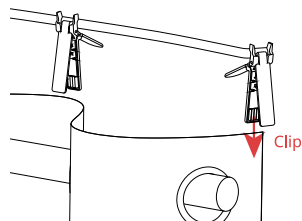

When you install all the Clips onto the curtain, try open and close it and make sure the Strip is straightened when closed. You can cut the rest of the Strip off or hide it behind the curtain.

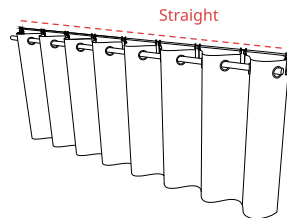

Place the Curtain onto the rod between the first and the second grommet behind the panel.

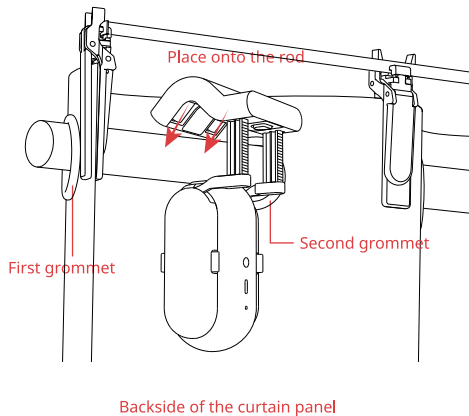

Compress the space between the Top Lid and the Motor using both of your hands until Curtain is firmly attached. (Warning: over-compressing may break the Hook.)

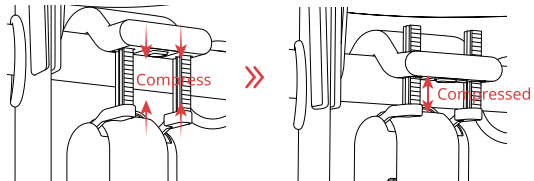

Installation complete. The Curtain should be hidden behind the panel.

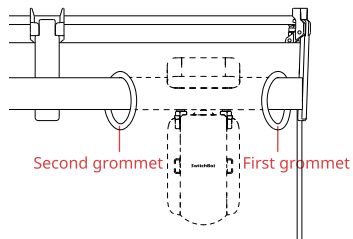

Install the Clip (Optional)

If you use double side curtain, you need two SwitchBot Curtains to open it from the middle. Alternatively, you can use the auxiliary Clip we provide to turn it into a single side curtain so that you only need one SwitchBot Curtain.

To do that, fully close the curtain so the 2 panels are closest to each other. Connect the upper parts of the two panels by using the Clip. Draw the curtain back and forth to make sure the two panels move as one. Then you can refer to Step 2: Install on Your Curtain Track on how to set the Curtain up.

Step 3: Calibration

Calibration is for your Curtain to adapt to your existing curtain track. You need to calibrate before you can control it from your phone or every time you change the Open Mode in the app. You can also redo the calibration on Curtain's Settings page.

Dealing with Telescopic Extendable Rod

If Curtain cannot move smoothly on the rod or it gets stuck at the connecting point during calibration, we have provided a Rod Connector to help fix the problems. Rod Connector is a flexible aluminum plate covered with a tape that is used to smoothen the slope between two connecting rods. Please follow these steps to install,

Move Curtain to the thicker end of the rod, preferably a few centimeters away from the connecting point.

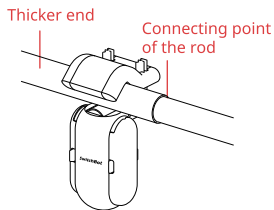

Remove the adhesive protection cloth from Rod Connector.



Stick one end of Rod Connector to the curtain rod, as shown in the graph.

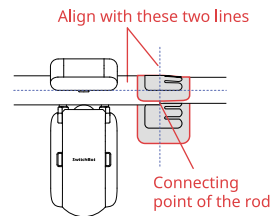

Wrap Rod Connector around the rod slowly while applying pressure to each segment of the metal plate against the thinner end of the rod.

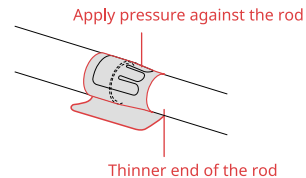

Rod Connector should be firmly adhered to the connecting section of the rod.

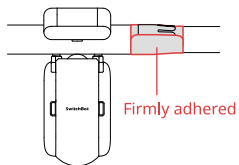

Resume to the app and redo the calibration. Curtain should be able to move through the rod without getting stuck.

If you continue to encounter problems, please reach us at support@wondertechlabs.com

Control

Lots of convenient ways to control, at your will.

App Control

Open and close the curtain at your fingertip. We offer intuitive App control for iOS and Android, with weekly/bi-weekly updates following feedback from you. OTA firmware update is also available for better user experience.



Touch & Go

Even with SwitchBot Curtain, you'd probably still instinctively draw the curtains by hand sometimes. When it senses you drawing the curtain, the SwitchBot Curtain will kick in and do the work for you. We call this Touch & Go.

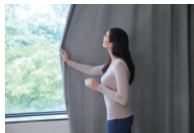

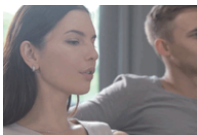

Voice Control and Home Automation*

Smart living is powered by your voice commands. Wouldn't it be great to just say it?

"Alexa, close the curtain."

"OK Google, close my bedroom curtain."

"Hey Siri, open the living room curtain."

* Require SwitchBot Hub Mini (sold separately).



Control with SwitchBot Remote (Sold Separately)

A wireless remote add-on for you to place anywhere.

Touch & Go

Even with SwitchBot Curtain, you'd probably still instinctively draw the curtains by hand sometimes. When it senses you drawing the curtain by more than 5 cm*, the SwitchBot Curtain will kick in and do the work for you.

For double side curtain, drawing on one side of curtain will trigger both Curtains to open or close simultaneously.

"Touch & Go" is turned on by default. To turn off, go to "Advanced Settings", and turn off "Touch & Go".

* 5 cm is the best threshold we tested because it lowers the possibility of false trigger by your cats and dogs.

Voice Control and Home Automation

You can link multiple third-party services to your SwitchBot account and control Curtain or scenes using voice commands. You must meet the following requirements in order to achieve voice control and automation,

- Connect your phone or tablet to the internet
- Set a SwitchBot Hub Mini up (sold separately)
- Enable Cloud Service on Curtain's Settings page
- Link third-party services to your SwitchBot account

Alexa, close the curtain.

OK Google, close my bedroom curtain.

Hey Siri, open the living room curtain.

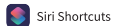

SwitchBot Scene

You can set up SwitchBot Scene for home automation within the SwitchBot eco-system when you turn on the Cloud Service within the Settings. There are unlimited possibilities.



Curtain



Remote



Curtain



Solar Panel



Curtain



Hub Mini



Meter

Control with SwitchBot Remote (Sold Separately)

You can control Curtain using a SwitchBot Remote. There are two buttons on Remote and you can set an action for each of them from the app. Please refer to Remote's user manual for more information.

Settings

Navigate to Curtain's detail page and settings page for a variety of features such as Light Sensing (Beta), Delay, Schedule, Motion Mode, and more.

Light Sensing (Beta)

The light sensing feature allows you to set automations based on the illuminance level or the relative intensity of sunlight. It's still in the beta stage and is being upgraded continuously, so please explore the details in the latest app release.

Delay

You can set up 1 Delay for countdown action. You can set the countdown time, percentage of opening or closing, and Motion Mode.

Schedule

You can set up 5 Schedules on board, or unlimited Schedules with a Hub. You can set the day, time, percentage of opening or closing, and Motion Mode.

Motion Mode

Performance Mode gives Curtain more power* to move, which results in higher noise level. This mode is good for daily uses.

Silent Mode gives Curtain less power to move, which results in lower noise level. The best use case for this mode would be when you wake up with sunshine.

* Move up to 8 kg / 17 pounds of curtain.

Charging, Firmware and Factory Reset

Charging

It takes about 10 hours¹ to fully charge the battery and the battery lasts 8 months after a full charge². You may also purchase our Solar Panel to charge by sunlight³.

1. 5V =1A adapter is required to charge with adapter.
2. Battery life is tested under condition of runway of 3 meters, loaded with 8 kg of curtain, opened and closed twice a day, 25°C. Battery life may vary given different condition.
3. Illuminance Level 6 is required to charge with Solar Panel.

Firmware

Please make sure you have the up to date firmware by upgrading in time.

Factory Reset

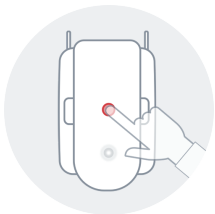

Long press the button for 15 seconds until the LED light lights up. Then release the button. If you are using double side curtain, you will need to redo the calibration on both Curtains.

Caution:

You may lose all the settings after Factory Reset and you may need to add the device again and redo the calibration.

Specification

Model Number: W0701600

Color: White / Black

Material: ABS plastic with UV-Resistant coating

Product Size (Main Body): 42mm x 51mm x 110mm

Product Net Weight (Main Body): 135g

Power: Battery-powered, Type-C, DC 5V= 1A. Battery lasts up to 8 months after a full charge or unlimited with Solar Panel.

Connectivity: Bluetooth 5.0 Long Range

Sensor: Accelerometer, light sensor

Strength: Up to 8 kg / 17 pounds of curtain (test results from controlled experiments in our lab)

Max Runway: 3 meters

Mode: Silent Mode / Performance Mode

Timer: Up to 5. Or unlimited with a Hub³

Voice Control (Hub Required): Amazon Alexa, Google Assistant, Siri Shortcuts, SmartThings, IFTTT, and LINE Clova

1. Solar Panel is sold separately.
2. Battery life is tested under condition of runway of 3 meters, loaded with 8 kg of curtain, opened and closed twice a day, 25°C. Battery life may vary given different condition.
3. Hub is sold separately.

Note: Use under regular temperature only.

Return and Refund Policy

This product has one-year warranty (start from the purchasing day). The situations below do not fit the Return and Refund Policy.

- Intended damage or abuse.
- Inappropriate storage (drop down or soaking in water).
- User modify or repair.
- Using loss.
- Force majeure damage (Natural disasters).

The batteries are not in the warranty.

Contact and Support

Setup and Troubleshooting: support.switch-bot.com

Support Email: support@wondertechlabs.com

Feedback: If you have any concern or problem when using our products, please kindly send feedback from the Profile > Feedback page in the SwitchBot app.

CE Warning

Manufacturer's Name: Woan Technology (Shenzhen) Co., Ltd.

Sample Description: SwitchBot Curtain

Trade Mark: SwitchBot

Model number: W0701600

Operating Temperature: -20°C~60°C

This product is a fixed location. To comply with RF exposure requirements, a minimum separation distance of 20cm must be maintained between the user's body and the device, including the antenna. Use only the supplied or an approved antenna.

This device in compliance with the essential requirements and other relevant provisions of Directive 2014/53/EU. All essential radio test suites have been carried out.

1. CAUTION : RISK OF EXPLOSION IF BATTERY IS REPLACED BY AN INCORRECT TYPE. DISPOSE OF USED BATTERIES ACCORDING TO THE INSTRUCTIONS.

2. The device complies with RF specifications when the device used at 20cm from your body.

FCC Warning

This device complies with part 15 of the FCC Rules. Operation is subject to the following two conditions: (1) This device may not cause harmful interference, and (2) this device must accept any interference received, including interference that may cause undesired operation. Any Changes or modifications not expressly approved by the party responsible for

compliance could void the user's authority to operate the equipment. This equipment has been tested and found to comply with the limits for a Class B digital device, pursuant to part 15 of the FCC Rules. These limits are designed to provide reasonable protection against harmful interference in a residential installation. This equipment generates uses and can radiate radio frequency energy and, if not installed and used in accordance with the instructions, may cause harmful interference to radio communications. However, there is no guarantee that interference will not occur in a particular installation. If this equipment does cause harmful interference to radio or television reception, which can be determined by turning the equipment off and on, the user is encouraged to try to correct the interference by one or more of the following measures:

- Reorient or relocate the receiving antenna.
 - Increase the separation between the equipment and receiver.
 - Connect the equipment into an outlet on a circuit different from that to which the receiver is connected.
 - Consult the dealer or an experienced radio/TV technician for help.
- The device has been evaluated to meet general RF exposure requirement. The device can be used in portable exposure condition without restriction. To maintain compliance with FCC's RF Exposure guidelines, This equipment should be installed and operated with minimum distance between 20cm the radiator your body: Use only the supplied antenna.

Warning: Changes or modifications to this unit not expressly approved by the part responsible for compliance could void the user's authority to operate the equipment.

KCC Warning

인증받은자의 상호: Woan Technology (Shenzhen) Co., Ltd.
제품명/모델명: 특정소출력 무선기기(무선데이터통신시스템용 무선기기) / W0701600
제조사 및 제조국가: Woan Technology (Shenzhen) Co., Ltd. /China
제조년월: 2020.06
인증번호: R-R-Woa-W0701600
이 장치는 보안성이 없으므로 통신보안에 위배되는 사항의 통신을 금지하며 운용 중

NCC 警語：

依據低功率電波輻射性電機管理辦法

第十二條

※經型式認證合格之低功率射頻電機，非經許可，公司、商號或使用者均不得擅自變更頻率、加大功率或變更原設計之特性及功能。

第十四條

※低功率射頻電機之使用不得影響飛航安全及干擾合法通信；經發現有干擾現象時，應立即停用，並改善至無干擾時方得繼續使用。
-前項合法通信，指依電信法規定作業之無線電通信。
-低功率射頻電機須忍受合法通信或工業、科學及醫療用電波輻射性電機設備之干擾。