



The INT-S-GR and INT-S-BL partition keypads are designed for work in conjunction with INTEGRA and CA-64 alarm control panels. They differ in the backlight color of their keys, which is green in the INT-S-GR and blue in the INT-S-BL. The partition keypads are used to control the arming mode in one partition, to perform a function of monitoring access and controlling operation of the electromagnetic door locks, as well as monitoring closure of those doors. The keypads make it possible to change the user code and call the functions controlling the external devices.

This manual applies to the partition keypad with firmware version 1.2.

1. Description of partition keypad

The partition keypad has 12 keys with permanent or temporary (automatically activated) mode backlight and LED indicators.

LED designation:

-  - **ALARM** (red color) - steady light indicates an alarm in the keypad controlled partition, while blinking indicates that an alarm was triggered in the partition.
-  - **ARMED** (green color) - steady light indicates that the partition to which the keypad is assigned has been armed. Blinking indicates countdown of the exit delay.
-  - **TROUBLE** (yellow color) - blinking indicates that a technical problem has occurred. The signaling applies to troubles from the entire alarm system, not only from the keypad controlled partition. The type of trouble can be checked on the LCD keypad. Arming the keypad controlled partition will disable the trouble signaling. Disarming the partition will restore the trouble signaling.

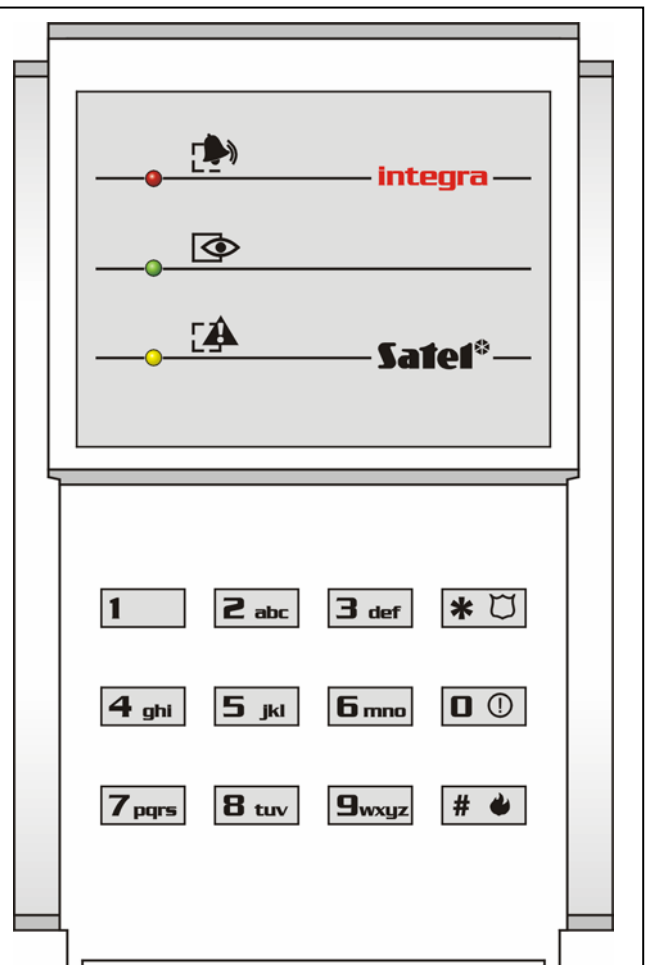

Figure 1. Partition keypad.

Alternative blinking of all the LEDs (from top to bottom) indicates lack of communication between the keypad and the control panel. This situation may take place when the STARTER

program is running in the control panel, or when the cable connecting the keypad and the control panel is damaged.

Note: All LEDs may be OFF in the arming mode, depending on the control panel settings.

Information on the use of the partition keypad can be found in the user manual of INTEGRA control panel.

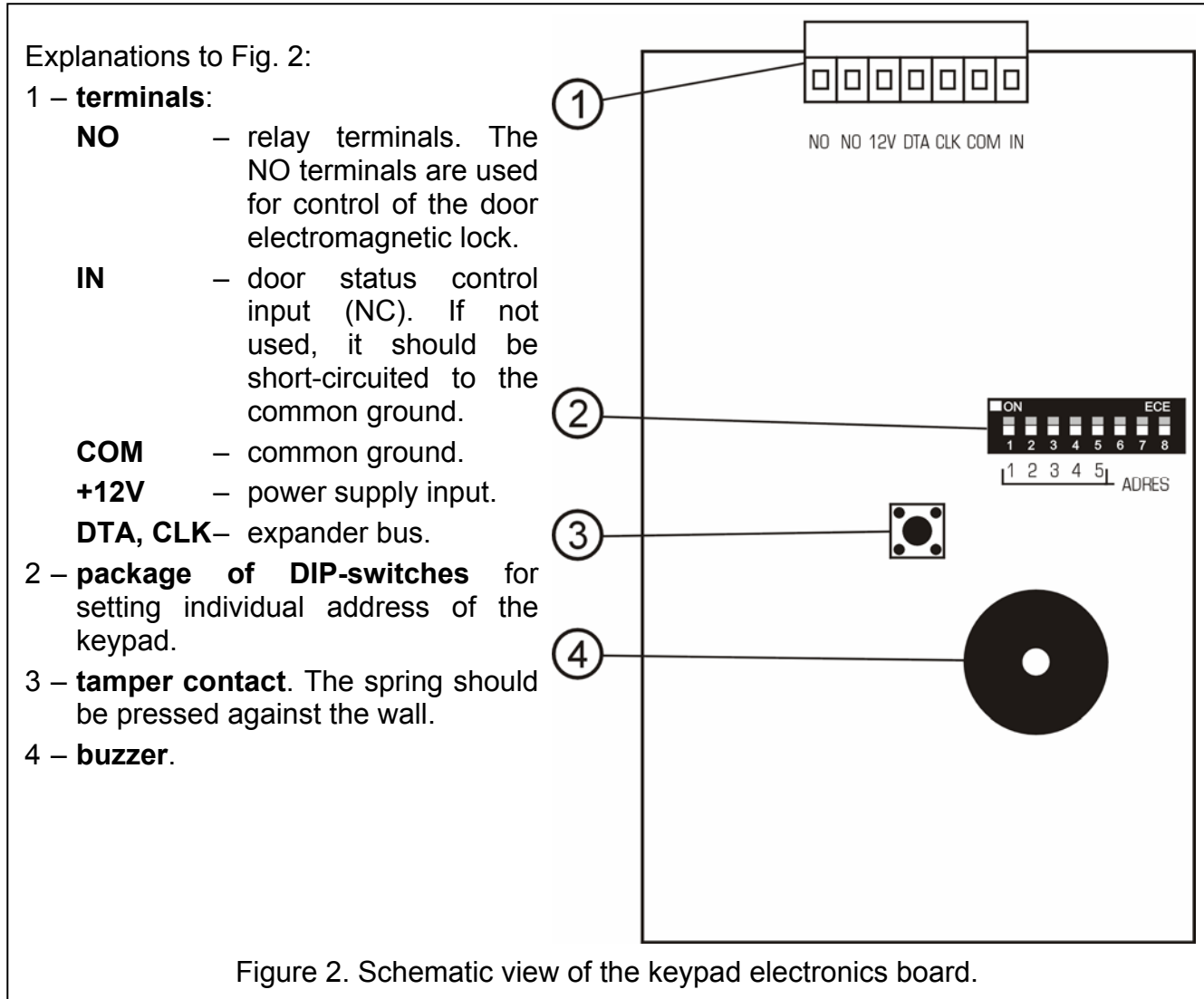

2. Installation and Connection of the Module

Note: Prior to hookup of the module to the existing alarm system, disconnect the whole system from the mains supply.

1. Push in the snap catch in the lower part of module plastic casing and remove the cover.
2. Pass the lead through the rectangular opening in the lower part of the casing.
3. Attach the lower part of the casing to the wall.
4. The terminals DTA, CLK and COM connect with wires to the expander bus on the control panel PCB.
5. Using the DIP-switches, set the keypad address. The address should be set by means of the switches 1 to 5 (the status of the other switches is irrelevant). This address must differ from those of the other modules connected to the control panel expander bus. In order to

determine the keypad address, add up the numbers set on particular DIP switches, according to Table 1.

Switch number	1	2	3	4	5
Numerical equivalent (DIP switch in ON position)	1	2	4	8	16

Table 1.

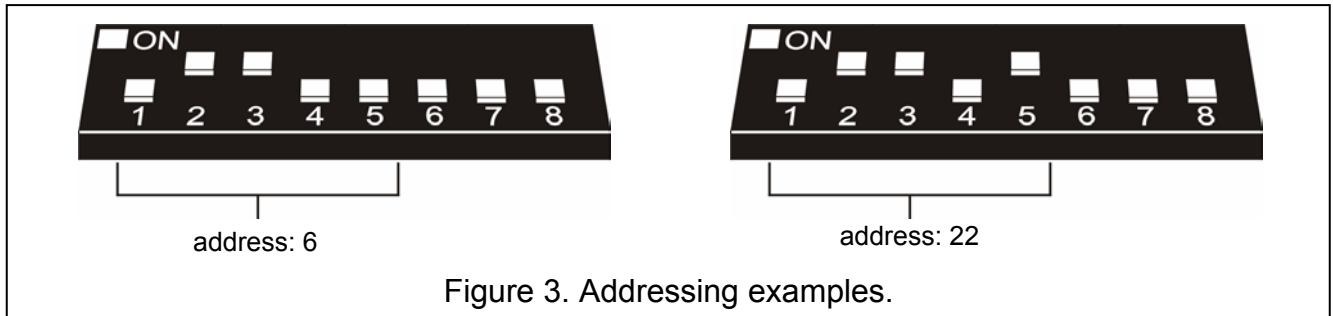

Figure 3. Addressing examples.

Five switches make it possible to assign addresses to 32 expanders (numbers from 0 to 31). The addresses of expanders connected to one bus cannot be repeated, but the addressing order can be random. It is recommended that consecutive addresses, starting from zero, be assigned to expanders and modules connected to one bus. This will allow to avoid problems during expansion of the system.

6. Connect the module supply to the +12V terminal. The keypad supply does not have to be provided from the control panel main board. An additional power supply unit or expander with power supply can be used for this purpose. Details regarding the cable connections are described in the installer's manual for the alarm control panel.
7. Connect the wires of the door state control sensor to the IN and COM terminals.
8. If the keypad is to serve as a code lock, connect the wires to control the electromagnetic door lock (or another device) to the NO terminals.
9. Close the casing.

3. Starting the Partition keypad

1. Switch on the alarm system power supply.
2. Call the „*Expander identification*” function (→Service mode; →Structure; →Hardware) from the LCD keypad. After identification, all the settings have either the value of zero or „none”, and the options are inactive. No acknowledgement when pressing the keys makes one think that the module fails to respond to entering a code.

Note: During the identification process, the control panel saves in the module memory a special (16-bit) number, used for checking the module presence in the system. Replacement of the module with another one (even having the same address set on the switches) without a new identification, will result in triggering the alarm (module tamper - verification error).

3. Using the LCD keypad or DLOADX / DLOAD64 program, configure the keypad functions and define the users authorized to use the given partition keypad.
4. Quit the service mode or the communication session with PC and save the data in the FLASH memory.

4. Programming the Partition Keypad Settings

The partition keypad can be programmed by means of the LCD keypad (→Service mode →Structure →Hardware →Expanders →Settings →*expander selection*) or a computer with the DLOADX / DLOAD64 program. Described below are settings and options available for programming. Abbreviations from the LCD keypad display are shown at some of the functions.

Name – the option to give an individual (16-character) name to the module. This option can be accessed in the LCD keypad as follows: →Service mode →Structure →Hardware →Expanders →Names → *expander selection*.

Partition - assignment of the keypad to a partition selected from the list.

Lock feature – the option available in the LCD keypad – its activation provides access to the **Lock** submenu.

Lock (DLOADX) / Lock feature (DLOAD64) – its activation provides access to the lock feature options.

The options "**Lock feature**" (LCD / DLOAD64) and "**Lock**" (DLOADX) refer to operating the electromagnetic door lock or another device that requires the access control) to be operated by means of the partition keypad. This function is made available to any user selected in the „Users” option. The operation is effected by controlling the **NO** relay contacts (closed; open). The normal (basic) state of the relay contacts depends on how the „Relay type” option is set. Description of the function refers to a typical application.

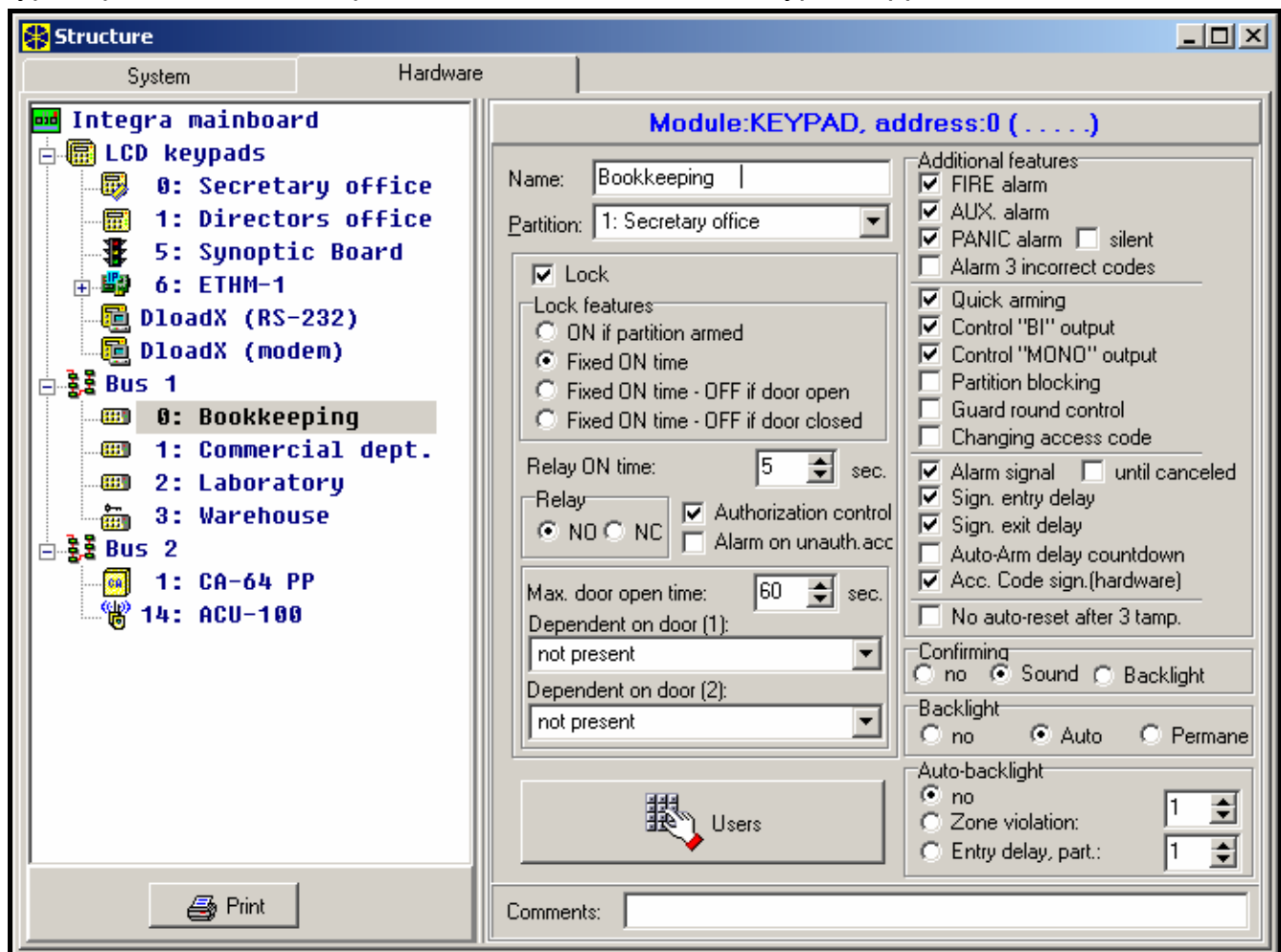

Figure 4. DLOADX program window with partition keypad options.

Lock feature (DLOADX) / Lock (DLOAD64)

ON if partition armed - selecting this option sets the bistable operating mode of the relay (i.e. it is active when the partition is armed and normal when the partition is disarmed).

Note: *When operating in this mode the relay will change its state automatically, if the partition is disarmed from the given keypad. When the partition is disarmed from another keypad, the state of the relay will change on entering the CODE and pressing the [*] key on the given partition keypad.*

Fixed ON time [ON time] - this option sets the monostable operating mode of the relay. When the door opening function is called by the user ([CODE] [*]), the relay gets activated for the time period entered in the „Relay ON time”, and then returns to its normal state.

Fixed ON time - OFF if door open [ON, open→off] - the relay is active until the door is opened (the IN input disconnected from common ground), but not longer than for the „relay ON time”.

Fixed ON time - OFF if door closed [ON, close→off] - the relay is active during the time when the door is open (the IN input cut off from the common ground) and deactivates on closing the door (reconnection of the IN input to common ground), but not longer than for the „relay ON time”.

Relay ON time – the time period during which the relay is active. Duration of the „relay ON time” can be from **1** to **255** seconds.

Relay - this option defines the operating mode of the relay contacts:

NO - the NO contacts are normally open, they close on activating the relay (during its active state),

NC - the NC contacts are normally closed, they open on activating the relay (during its active state).

Authorization control [Unauth. event] – opening the door without entering a password from the keypad (e.g. with the key) will generate an „Unauthorized door opening” event, it can also be signaled on the output type 93 (UNAUTHORIZED ACCESS).

Alarm on unauth. access [Unauth. alarm] – when the partition to which the module is assigned is armed, unauthorized opening of the door will trigger the alarm and can be additionally signaled on the output type 94 (ALARM – UNAUTHORIZED ACCESS).

Max. door open time - this option defines the time after expiry of which the module will report the „Long opened door” event to the control panel and activate the audible alarm. The duration can be set from **0** to **255** seconds.

Dependent on door 1 (or Dependent on door 2) - this function provides a list to choose the door which must be closed for the lock to operate. Monitoring of the door state is effected through the IN input in the partition keypad, code lock or CA-64 SR expander of proximity card readers, or through the zone type 57 (TECHNICAL - DOOR OPEN). Two dependent doors can be selected. The function allows to create a „sluice” type passage.

Master users / Users - this function defines master users / users authorized to use the given keypad.

Alarms

FIRE alarm - holding down the 🔥 key will trigger the fire alarm.

AUX. alarm [Medical alarm] - holding down the Ⓜ key will trigger the auxiliary alarm.

PANIC alarm - holding down the 🚪 key will trigger the PANIC alarm.

Silent PANIC alarm - with this option selected, triggering the panic alarm from the keypad will not set off the loud signaling; instead, a message will be sent to the monitoring station and the output type 12 (SILENT ALARM) will be activated.

Alarm 3 incorrect codes [3 wrong codes] - entering a code unknown to the control panel three times will trigger alarm.

Options

Quick arming - arming by pressing successively the [0] and [#] keys.

Control BI output – the keypad accepts the "*BI output control*" type of codes.

Control MONO output – the keypad accepts the "*MONO output control*" type of codes.

Partition blocking - entering the guard code when the partition is armed will temporarily bypass the partition.

Guard round control - entering the guard code ([CODE][#] or [CODE][*]) will be recorded as completion of the round.

Changing access code - this option enables the function of the user code changing.

Signaling

Alarm signaling (fixed time) - acoustic alarm signaling in the given partition (through the total duration of alarm).

Alarm signaling (latch) - acoustic alarm signaling in the given partition until the alarm is cleared.

Signaling entry delay - acoustic signaling of the countdown of entry delay time.

Signaling exit delay - acoustic signaling of the countdown of exit delay time.

Auto-Arm delay countdown– the keypad will be acoustically signaling the countdown of the auto-arming delay in the partition it has been assigned to.

Access code signaling (hardware) – enabling this option will activate the signaling of code entry acknowledgement, which is independent of the control panel. The option is useful in expanded alarm systems, because of a considerable time lag between entering the code and generating the audible signal by the control panel. Option is available only in the INTEGRA control panel.

Confirming - this option defines the way of communication between the control panel and the partition keypad user:

No – the function of keypad operation acknowledgement is disabled.

Sound - the keypad will generate beeps as described in the user manual for the alarm control panel.

Backlight - the audible signaling will be replaced by the blinking keypad illumination as described in the user manual for the alarm control panel.

Backlight - defines the mode of keypad illumination

No - keypad backlighting disabled.

Auto - keypad backlighting goes on automatically on pressing any key; the function has additional options (submenu „Auto-backlight” in LCD keypad):

- **no auto-backlight** - illumination only activated by pressing one of the keys,

- **zone violation** - backlighting activated by pressing a key or by violation of the zone,

- **entry delay, part.** - backlighting activated by pressing a key or by starting the countdown of entry delay time in the indicated partition.

Note: *Automatic keypad illumination is ON for approx. 40 seconds from the moment of its activation or from the last press of any key.*

Permanent - keypad backlighting is permanently "ON".

No auto-reset after 3 tampers - each expander automatically disables the tamper alarming in the given expander after three consecutive (not cleared) tamper alarms. This prevents multiple recording of the same events in the control panel memory. The option allows this feature to be disabled.

5. Technical Data

Nominal supply voltage ($\pm 15\%$)	12V DC
Maximum current consumption	66mA
Average current consumption	24mA
Maximum voltage switched over by relay	24V
Maximum current switched over by relay	2A
Dimensions (length x height x width)	80x127x24mm

The latest EC declarations of conformity and certificates are available for
downloading on the website **www.satel.pl**



SATEL sp. z o.o.
ul. Schuberta 79
80-172 Gdańsk
POLAND
tel. + 48 58 320 94 00
info@satel.pl
www.satel.pl