

CARATTERISTICHE

Scrocco e 3 catenacci avanzanti

Reversibile
Frontale piatto da 22-25 mm o frontale ad U 23 mm – **in acciaio inox**
Interasse 85 mm
Entrate 25 – 30 e 35 mm
Alimentazione 12 V

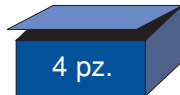

FEATURES

Spring latch and 3 bolts

Reversible
Flat front plate 22-25 mm or U shaped front plate 23 mm – **stainless steel**
Distance 85 mm
Backset 25 – 30 e 35 mm
Power supply 12 V



Articolo Article	Entrata Backset E	B	Quote Dimensions A	Frontale Front plate
7450/1	25	34	40	23x6 mm
7450/2	30	39	45	
7450/3	35	44	50	
7451/1IN	25	37	40	25x3 mm
7451/2IN	30	42	45	
7451/3IN	35	47	50	
7452/1IN	25	37	40	22x3 mm
7452/2IN	30	42	45	
7452/3IN	35	47	50	

MINI AVANT

Serratura da montante a 1 o 3 punti di chiusura
Narrow style lock 1 or 3 locking points

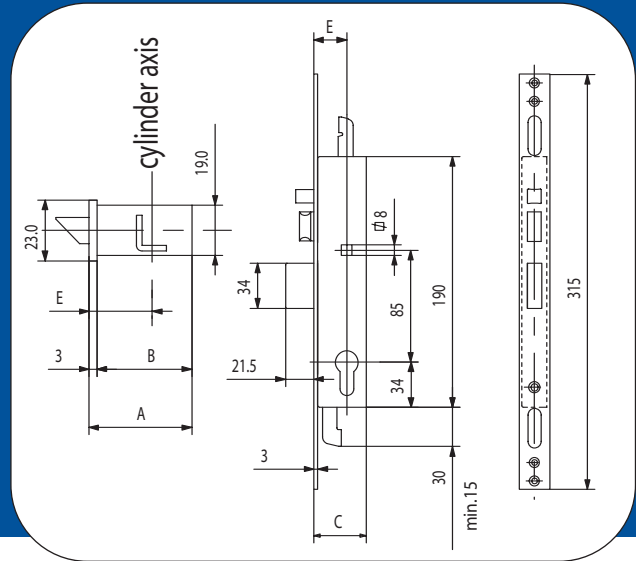

CARATTERISTICHE

Scrocco e catenaccio avanzante
1 o 3 punti di chiusura
Reversibile
Coprifrontale 23 e 25 mm - **in acciaio inox**
Interasse 85 mm
Entrate 25, 30 e 35 mm
Alimentazione 12 V

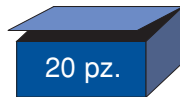

FEATURES

Spring latch and bolt
1 or 3 locking points
Reversible
Front cover 23 and 25 mm – **stainless steel**
Distance 85 mm
Backset 25, 30 e 35 mm
Power supply 12 v



MINI AVANT

La gamma
Range

Articolo Article	Entrata Backset E	Quote Dimensions B A	Descrizione Description	Coprifrontale Front cover
7751P/1	25	37 40	1 punto di chiusura 1 locking point	23 mm
7751P/2	30	42 45		
7751P/3	35	47 50		
7753P/1	25	37 40	3 punti di chiusura 3 locking points	23 mm
7753P/2	30	42 45		
7753P/3	35	47 50		
7755P/1	25	37 40	1 punto di chiusura 1 locking point	25 mm
7755P/2	30	42 45		
7755P/3	35	47 50		
7758P/1	25	37 40	3 punti di chiusura 3 locking points	25 mm
7758P/2	30	42 45		
7758P/3	35	47 50		

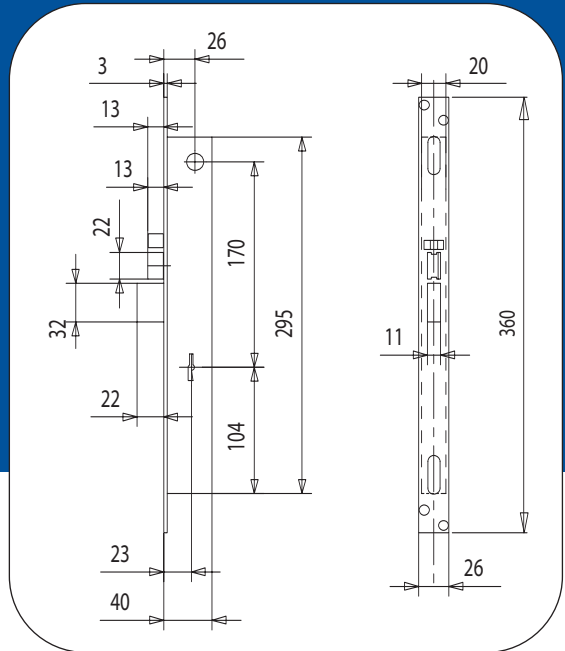
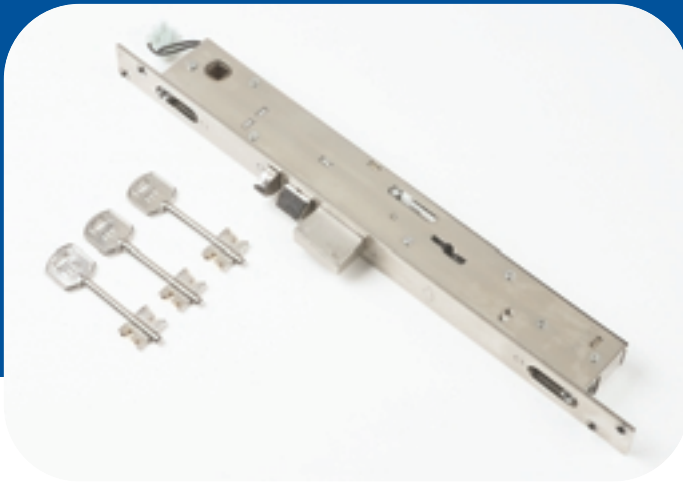

CARATTERISTICHE

Scrocco e catenaccio a 2 mandate
 1 o 3 punti di chiusura
 Reversibile
 Coprifrontale 26 mm - **in acciaio inox**
 Alimentazione a 12 v
 Con incontro

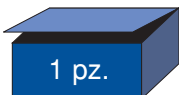

FEATURES

Spring latch and 2 throws dead bolt
 1 or 3 locking points
 Reversible
 Front cover 26 mm - **stainless steel**
 Power supply
 With striker

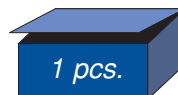

Articolo Article	Descrizione Description
6701	1 punto di chiusura 1 locking point
6703	3 punti di chiusura 3 locking points

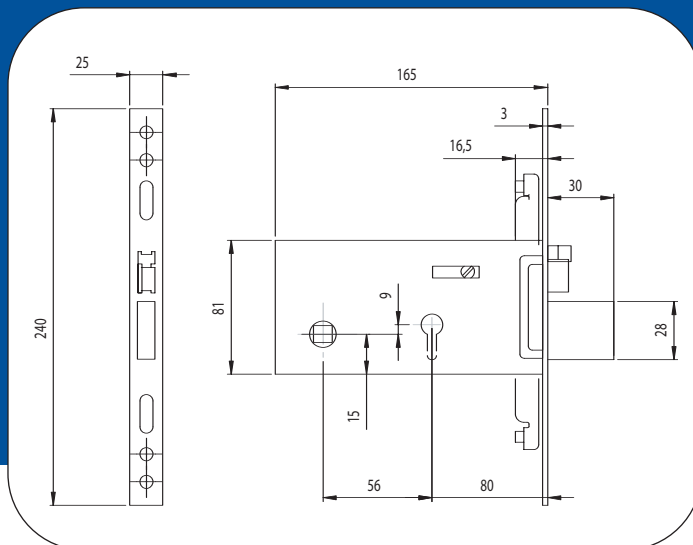

CARATTERISTICHE

Scrocco e catenaccio a 3 mandate
1 o 3 punti di chiusura
Reversibile
Coprifrontale 25 mm - **in acciaio inox**
Entrata 80 mm
Alimentazione 12 V

FEATURES

Spring latch and 3 throws dead bolt
1 or 3 locking points
Reversible
Front cover 25 mm - **stainless steel**
Backset 80 mm
Power supply 12 V

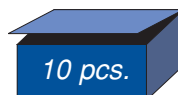
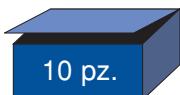

Articolo Article	Descrizione Description
5701	1 punto di chiusura 1 locking point
5713	3 punti di chiusura 3 locking points

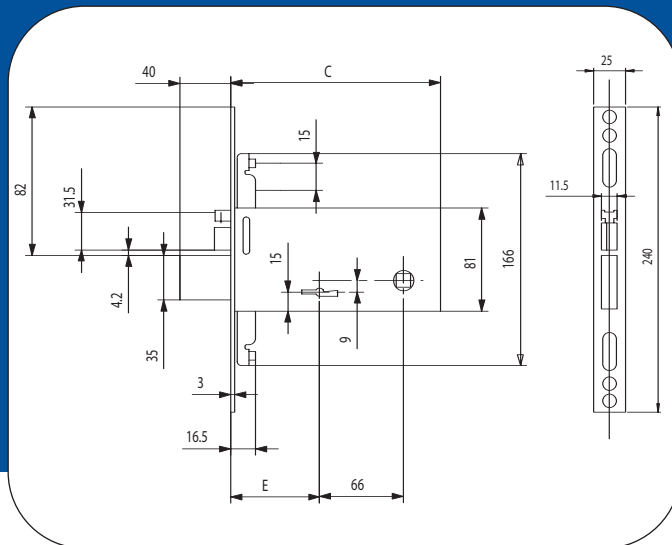

CARATTERISTICHE

Scrocco e catenaccio a 4 mandate
1 o 3 punti di chiusura
Reversibile
Coprifrontale 25 mm - **in acciaio inox**
Entrata 70 e 90 mm
Alimentazione 12 V

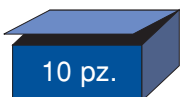

FEATURES

Spring latch and 4 throws dead bolt
1 or 3 locking points
Reversible
Front cover 25 mm – **stainless steel**
Backset 70 and 90 mm
Power suppli 12 V

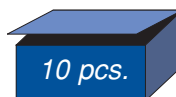

Articolo Article	E Entrata Backset	C Quota Dimension	Descrizione Description
6971	70	165	1 punto di chiusura 1 locking point
6991	90	185	
6973	70	165	3 punti di chiusura 3 locking points
6993	90	185	

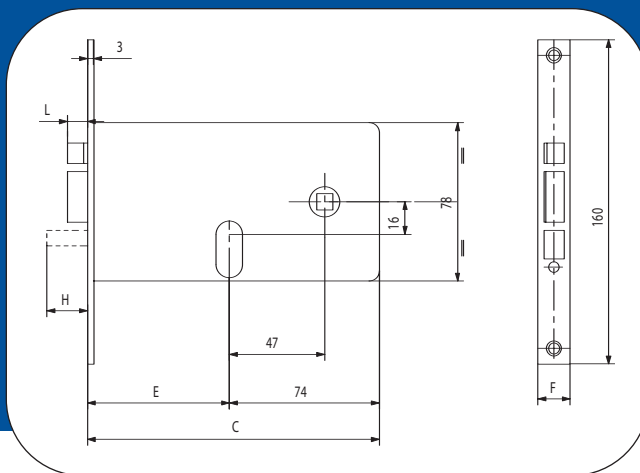

CARATTERISTICHE

Scrocco e 2 mandate
Reversibile
Entrata 60, 70 e 80 mm
Alimentazione 12 V

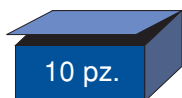

FEATURES

Spring latch and 2 throws dead bolt
Reversible
Backset 60, 70 and 80 mm
Power supply 12 V

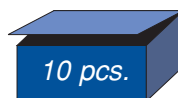

Articolo Article	Entrata E Backset	Quote serratura F C		Lock dimensions L H		Nota Note
		F	C	L	H	
6353	60	16	134 mm	10	20	Con cilindro With cylinder
6354		20				
6355	70	16	144 mm			
6356		20				
6357	80	16	154 mm			
6358		20				
6359		14,5		15	25	Senza cilindro Without cylinder

525

Serratura da fascia Midrail lock



CARATTERISTICHE

Non Reversibile
Entrata 75 mm
Alimentazione 8-12 V

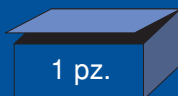

FEATURES

Non Reversible
Backset 75 mm
Power supply 8-12 V



525

La gamma Range

Articolo Article	Nota Note
525/5	Dx Rhs
525/6	Sx Lhs

550

Serratura da fascia Midrail lock



CARATTERISTICHE

Non Reversibile
Entrata 60 mm
Alimentazione 8-12 V

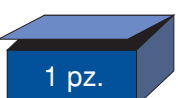

FEATURES

Non Reversible
Backset 60 mm
Power supply 8-12 V



550

La gamma Range

Articolo Article	Nota Note
550/5	Dx Rhs
550/6	Sx Lhs

500

Apriporta Door open



CARATTERISTICHE

Da abbinare alle serrature
meccaniche con tirante
Alimentazione 8-12 V

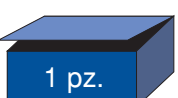

FEATURES





To use with mechanical rim locks
Power supply 8-12 V





500

La gamma Range

Articolo Article	Nota Note
500/5	Dx Rhs
500/6	Sx Lhs

Articolo Article	Descrizione Description	Per serrature For locks	
6850/2	NC 40	Mini-Avant Tripla Elettromappa da fascia Elettromappa madrail locks	
6850/4	Asta/rod 5mm		
6850/6	Asta/rod 7mm		
6850/9	Alpha		
Attacchi speciali per profili aste esterne Set for central joint flush system			
6348	Sottofrontale in nylon Nylon shim	Elettrocombi	
6821	Coppia placche guida chiave in nylon Pair of key guide plates - nylon	Elettromappa da montante Elettromappa narrow style locks	
6824	Coppia placche guida chiave in nylon Pair of key guide plates - nylon		
6816	Bocchetta a pavimento Floor striker		
6816	Bocchetta a pavimento Floor striker	Elettromappa da fascia Elettromappa midrail locks	
6828	Coppia aste verticali diritte Vertical rods	Tutte le serrature a 3 punti di chiusura For all 3 locking points	
6827	Coppia aste verticali piegate Vertical rods		

Articolo Article	Descrizione Description	Per serrature For locks	
6814	Coppia puntali antisega Ø 8 mm <i>Pair of shoot ends Ø 8 mm</i>	Per tutte le aste <i>For all rods</i>	
6815	Coppia puntali antisega Ø 6 mm <i>Pair of shoot ends Ø 6 mm</i>		
6360	Coppia contatti <i>Contact set</i>		
803/1	Bobine <i>Coils</i>	500	
804		Multipla	
805		Tripla Elettromappa da fascia <i>Elettromappa madrail locks</i>	
806		Segreta	
811		Elettromappa da montante <i>Elettromappa narrow style locks</i>	
812		525-550	
814		Elettrocombi	
815		Avant - Mini Avant	