

Smart Video Intercom Access



User Manual

Introduction

The device is Touch Key Access Controller with WiFi-enabled Intercom. People can install the APP for intercom with their smart phone, and program the access controller by touch key.

It is compatible with both iOS (7.0 above) and Android (4.3 above).

Features:

Intercom

- > 2.4G WiFi connection
- > Android and iOS available
- > Full duplex voice intercom
- > 2MP+wide angle camera and night vision
- > Support TF card with unlimited capacity
- > Support motion detection, playback, take picture/video, unlock remotely

Access Control

- > Touch key with one relay, 1000 users (988 common+2 panic+10 visitor)
- > Fingerprint version support 100 fingerprint users
- > PIN Length: 4~6 digits
- > EM card, Mifare card optional
- > Wiegand 26~44 bits input & output
- > Can be used as Wiegand reader with LED & buzzer
- > User data can be transferred
- > 2 devices can be interlocked for 2 doors

Specification:

Video Intercom	Network	2.4G WiFi connection
	Pixel	2.0Mpx (1080P)
	Visual Angle	Horizontal 140° wide angle
	Night Vision	IR-CUT (Colorful at daytime, black and white at night)
	Extended Memory	TF card with unlimited capacity
	Intercom	Full duplex voice intercom
	Other Functions	Motion detection; Playback; Take picture/video; Unlock remotely

Access Control	User Capacity Common User Visitor User Panic User	1000 (Fingerprint version : 100 fingerpints) 988 10 2
	PIN Length	4~6 digits
	Proximity Card Reader Radio Technology Read Range	EM or Mifare 125KHz/13.56MHz 2~6cm
	Wiring Connections	Relay output, exit button, alarm, door contact, Wiegand input/output
	Relay Adjustable Relay Output Time Lock Output Load	One (NO, NC, Common) 0~99 Seconds (5 seconds default) 2 Amp Maximum
	Wiegand Interface PIN Output	EM card version: Wiegand 26~44 bits input & output (Factory default: Wiegand 26bits) Mifare card version: Wiegand 26~44 bits input & output (Factory default: Wiegand 34bits) 4 bits, 8 bits (ASCII), 10 digits Virtual Number (Factory default: 4bits)
Electric	Operating Voltage Idle Current Active Current	DC 12V <150mA <250mA
	Environment Operating Temperature Operating Humidity	Indoor or Outdoor -20°C ~ 60°C (-4°F ~ 140°F) 0%RH ~ 86%RH
	Physical Color Dimensions Unit Weight Shipping Weight	Zinc-Alloy Sliver & Black L145 x W68 x D25(mm) Rectangle L149 x W70 x D25(mm) Ellipse L147 x W56 x D26(mm) Waterproof 450g (Rectangle) / 400g (Ellipse) / 470g (Waterproof) 550g (Rectangle) / 500g (Ellipse) / 570g (Waterproof)

Carton Inventory:

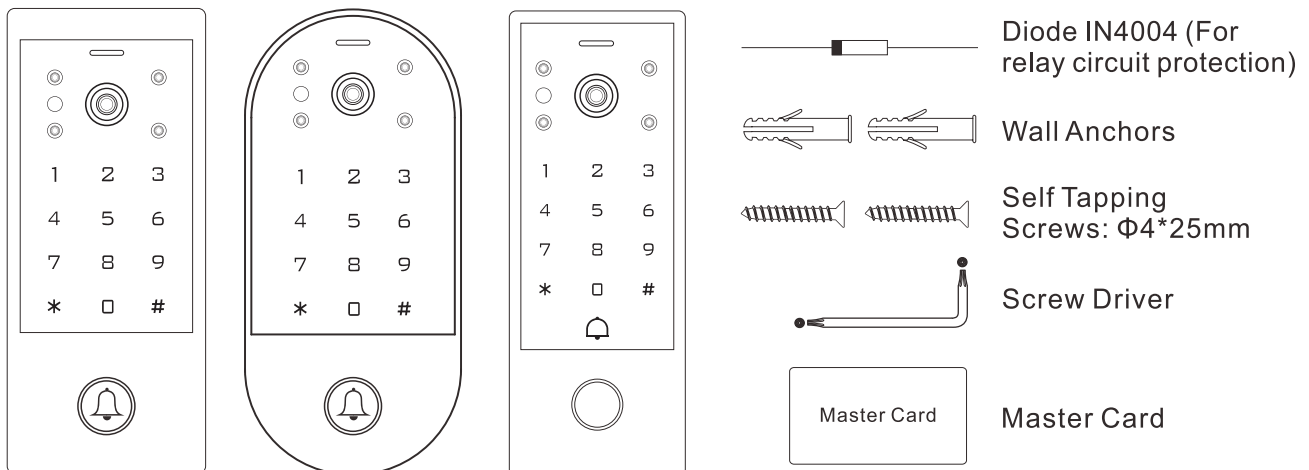

Installation

- > Remove the back cover from the unit
- > Drill 2 holes(A,C) on the wall for the screws and one hole for the cable
- > Knock the supplied rubber bungs to the screw holes(A,C)
- > Fix the back cover firmly on the wall with 4 flat head screws
- > Thread the cable through the cable hole(B)
- > Attach the unit to the back cover

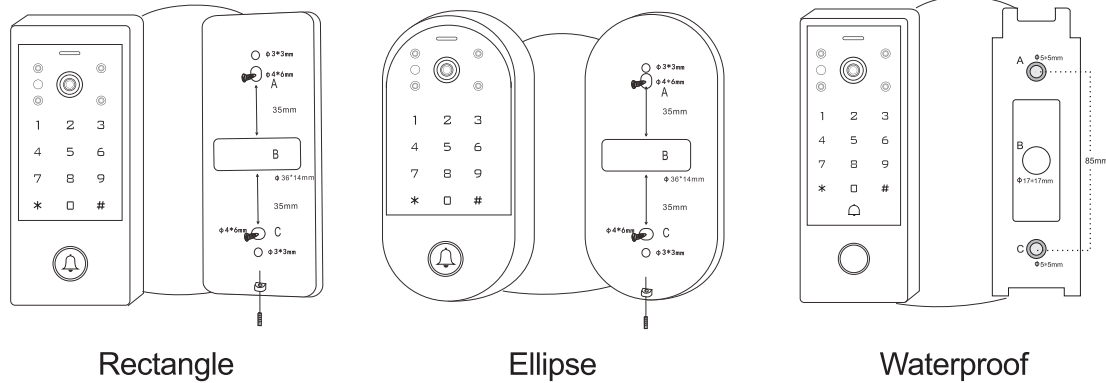

Wiring

Wire Color	Function	Notes
Basic Standalone Wiring		
Red	DC +	12V DC Power Input
Black	GND	Negative Pole of DC Power Input
Blue	Relay NO	Normally Open Relay Output (install diode provided)
Purple	Relay Common	Common Connection for Relay Output
Orange	Relay NC	Normally Closed Relay Output (Install diode provided)
Yellow	OPEN	Request to Exit(REX) Input
Pass-Through Wiring (Wiegand Reader or Controller)		
Green	Data 0	Wiegand Output (Pass-through) Data 0
White	Data 1	Wiegand Output (Pass-through) Data 1
Advanced Input and Output Features		
Grey	Alarm Output	Negative contact for Alarm
Brown	Contact Input	Door/Gate Contact Input (Normally Closed)

Sound and Light Indication

Operation Status	LED	Buzzer
Stand by	Red light bright	—
Enter into programming mode	Red light shines	One beep
In the programming mode	Orange light bright	One beep
Operation error	—	Three beeps
Exit from the Programming mode	Red light bright	One beep
Open lock	Green light bright	One beep
Alarm	Red light Shines quickly	Beeps

APP Operation

Here are just a few steps to get you started.

1) Free APP Downloading

Search TuyaSmart or Smartlife on Google Play or APP Store



2) Make sure WiFi works on your mobile phone.

1. Register & Login

(Make sure the registered email is legal and valid, so that you can recover your password once forgotten. **Mobile Number is for China Mobile ONLY**)

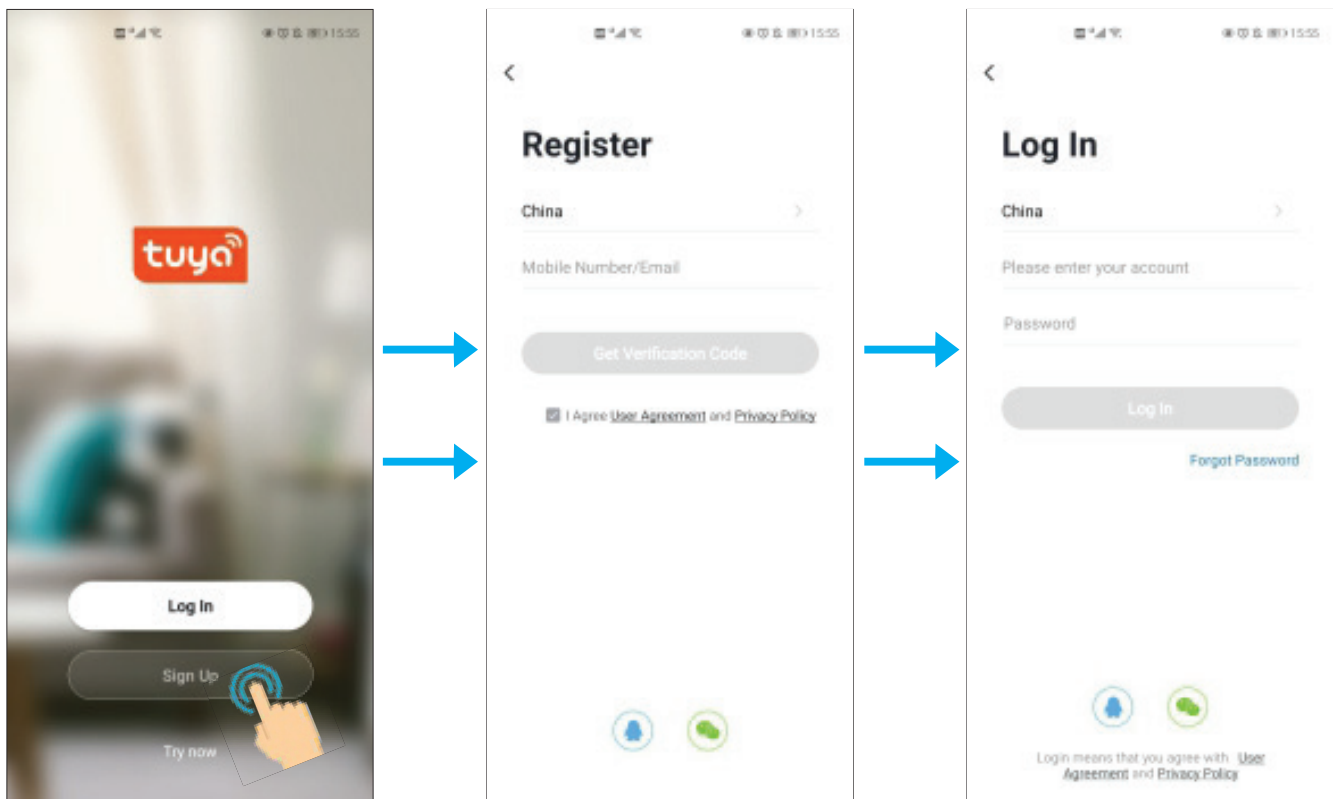

You will get a verification code in your mail box.





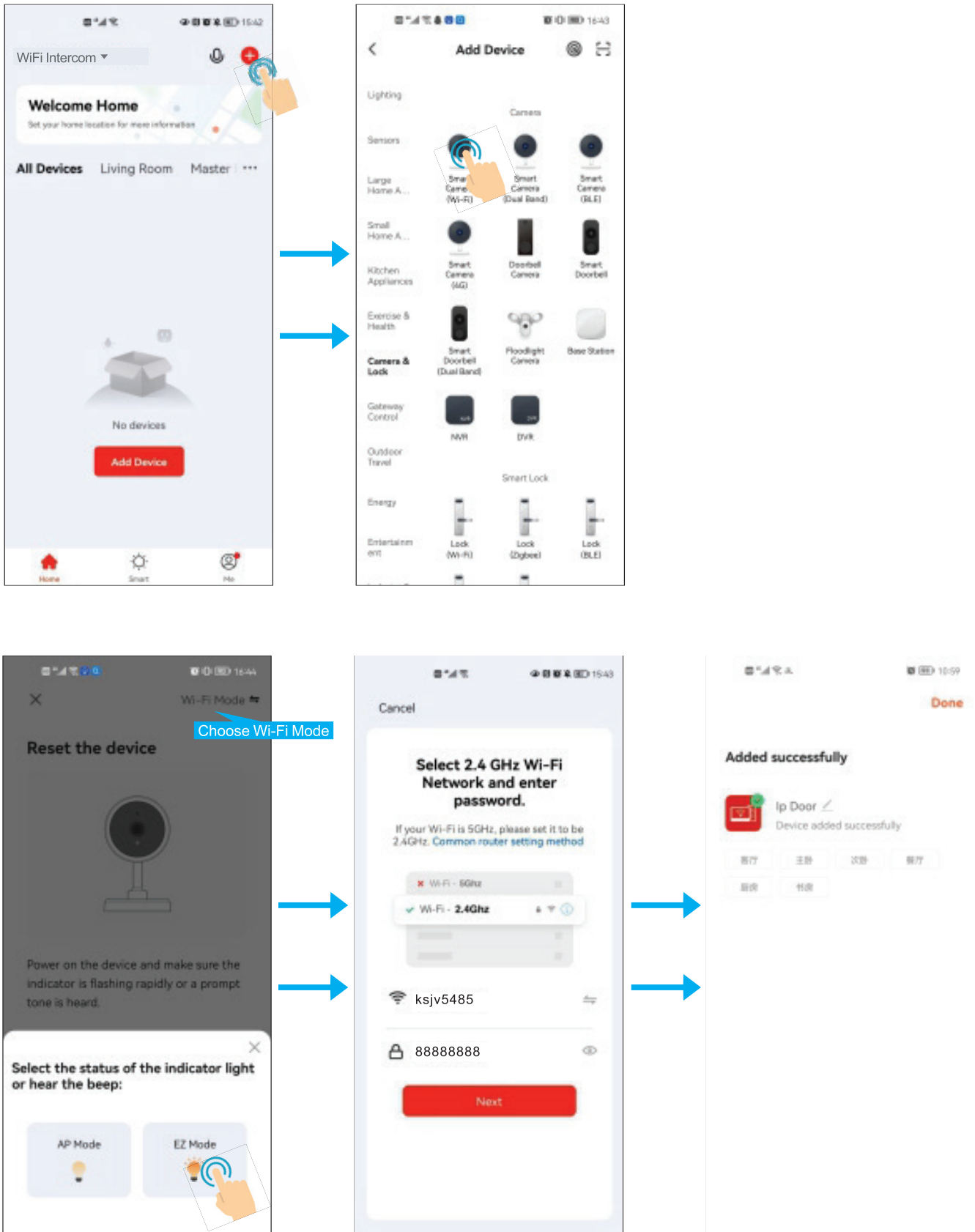



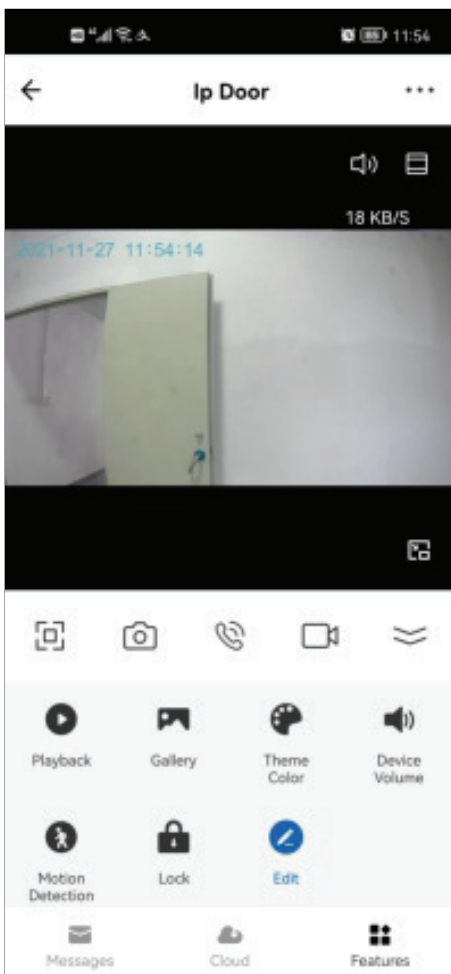
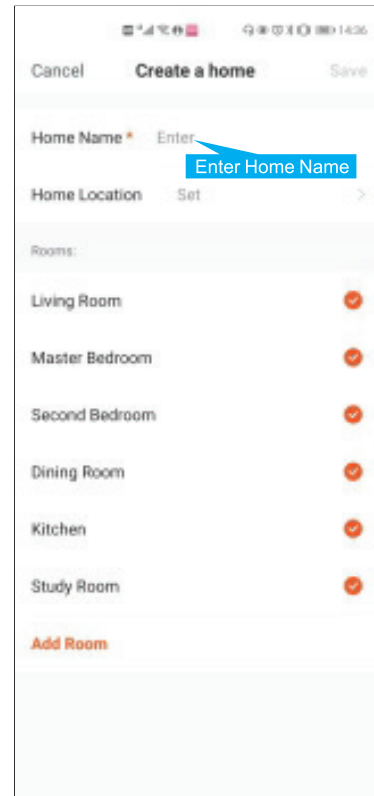
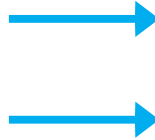
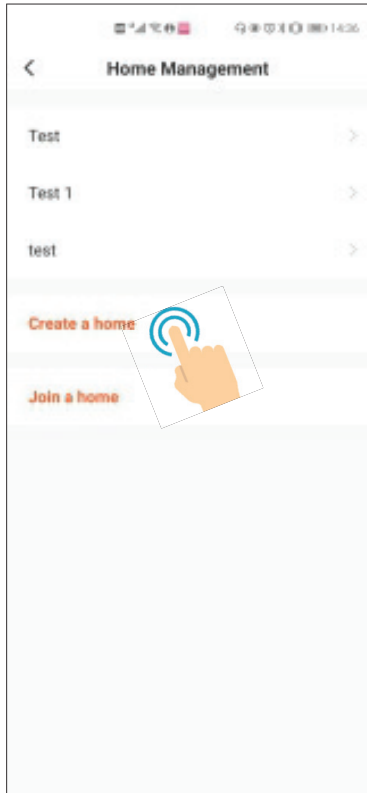

2. Add Device

You can add device by clicking 'Add Device' or clicking '+' on the top. Before Adding the device, please make sure it is in adding mode (Door bell LED flashes slowly).



Note: To better manage the devices and family members, you will need to create a HOME before you begin to manage this device.



-  [Intercom voice ON/OFF](#)
-  [Full screen](#)
-  [Take a picture](#)
-  [Intercom ON/OFF](#)
-  [Take a Video](#)
-  [Check the Alarm video record \(To use this function, must insert a TF card in the device\)](#)
-  [Check the picture or video](#)
-  [Change the theme color](#)
-  [Adjust the volume of device](#)
-  [Motion detection ON/OFF](#)
-  [Unlock the door](#)

3. Operation

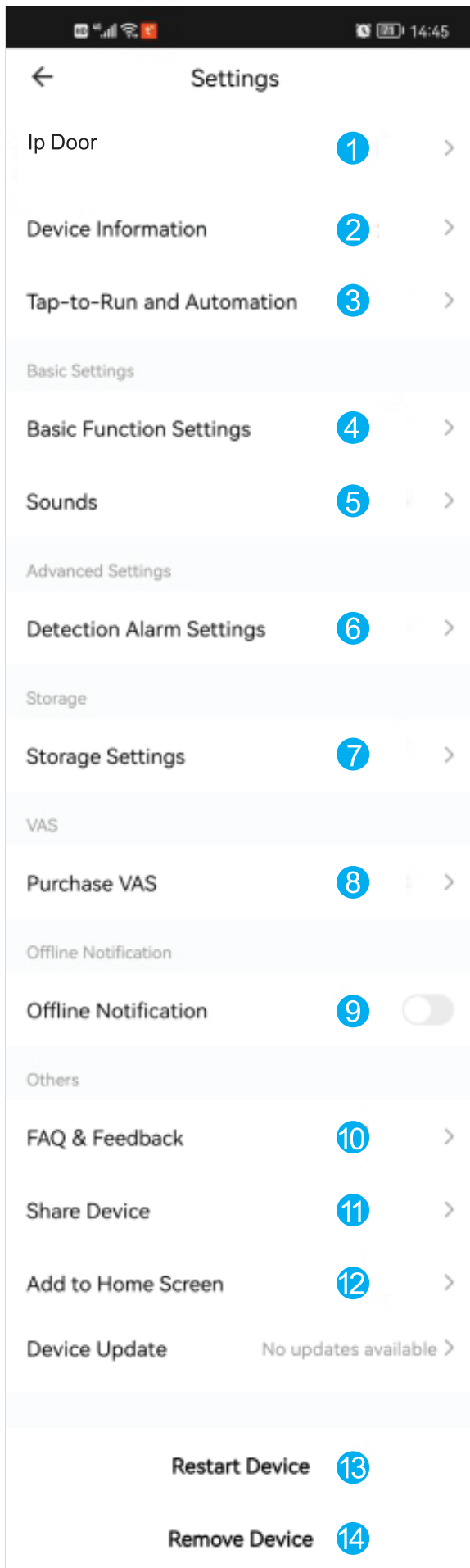

- 1 Revise device name and location
- 2 Check IP address, ID and time zone of device
- 3 Configure one or more devices' automation
- 4 Door bell LED ON/OFF; Flip screen
- 5 Adjust device volume
- 6 Motion detection ON/OFF, set the detection sensitivity, set alarm timer
- 7 Check the capacity (Total/Used/Remaining) of TF card, and format TF card
- 8 Value-added Service
- 9 If turn on it, a notification will be sent after device stayed offline in 30 minutes.
- 10 Check the FAQ related to device
- 11 Share the device by Tuya account, message, email, or chat APPs. (Shared Users can't unlock the door and set the device, only Family Members can unlock the door.)
- 12 Add a shortcut to your home screen.
- 13 Restart the device
- 14 Remove the device

4. Intercom Calling and Motion Detection

1. The APP is online when intercom calling

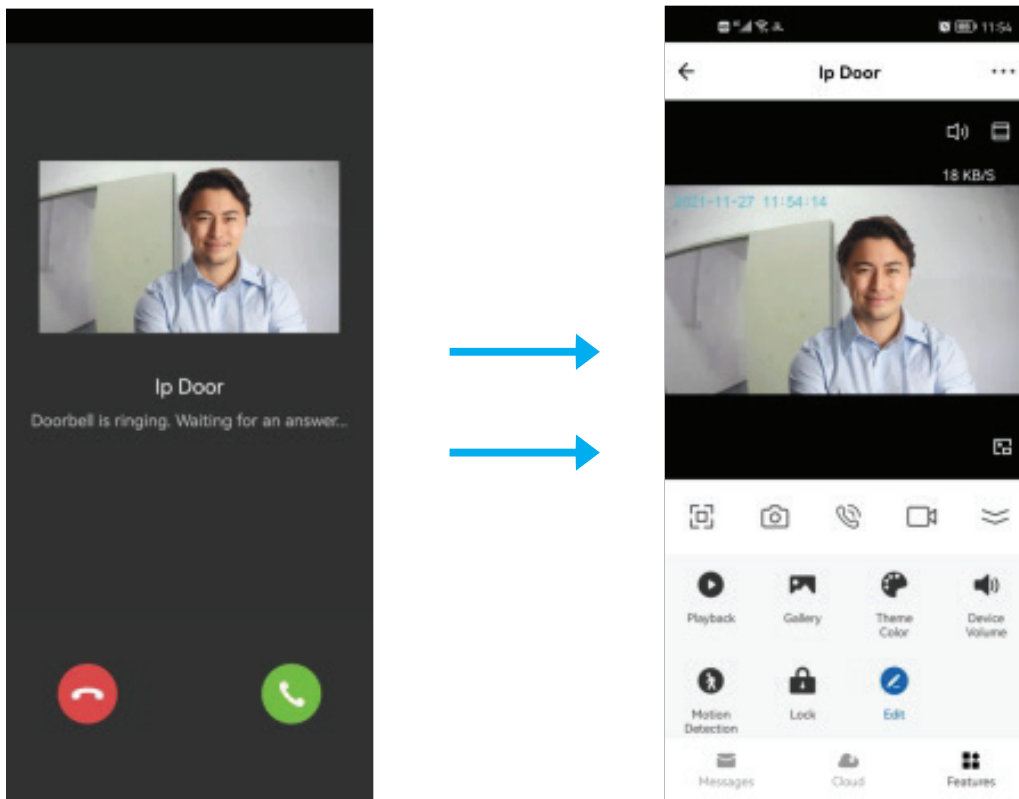

2. The mobile is standby when intercom calling or detecting motion

2.1 Click "You have a visitor" message into the intercom interface

2.2 Click "Motion detected" message into alarm record interface

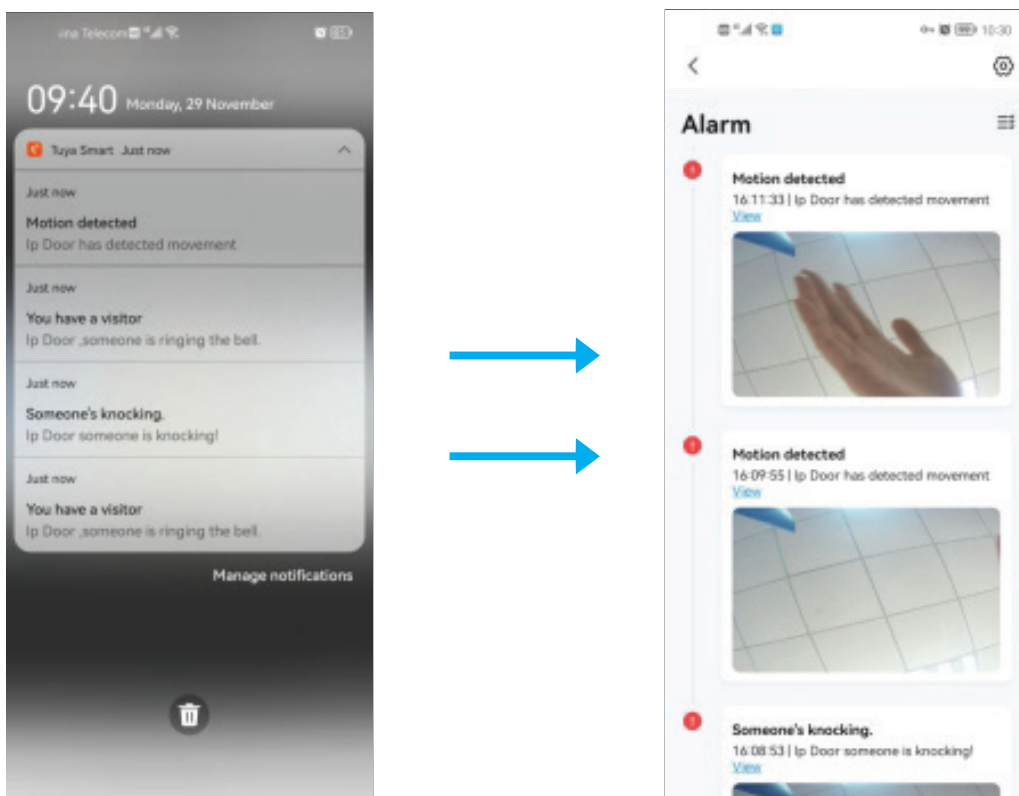



140° Wide Angle



Touch Button



Multi-users



Max 2.0Mpx



Support TF Card



Monitoring



Video Talking



Night Vision



Remote
Unlocking

Note: There are two ways to check the alarm record

1. Click the Message button in the intercom interface
2. Check in the Message Center

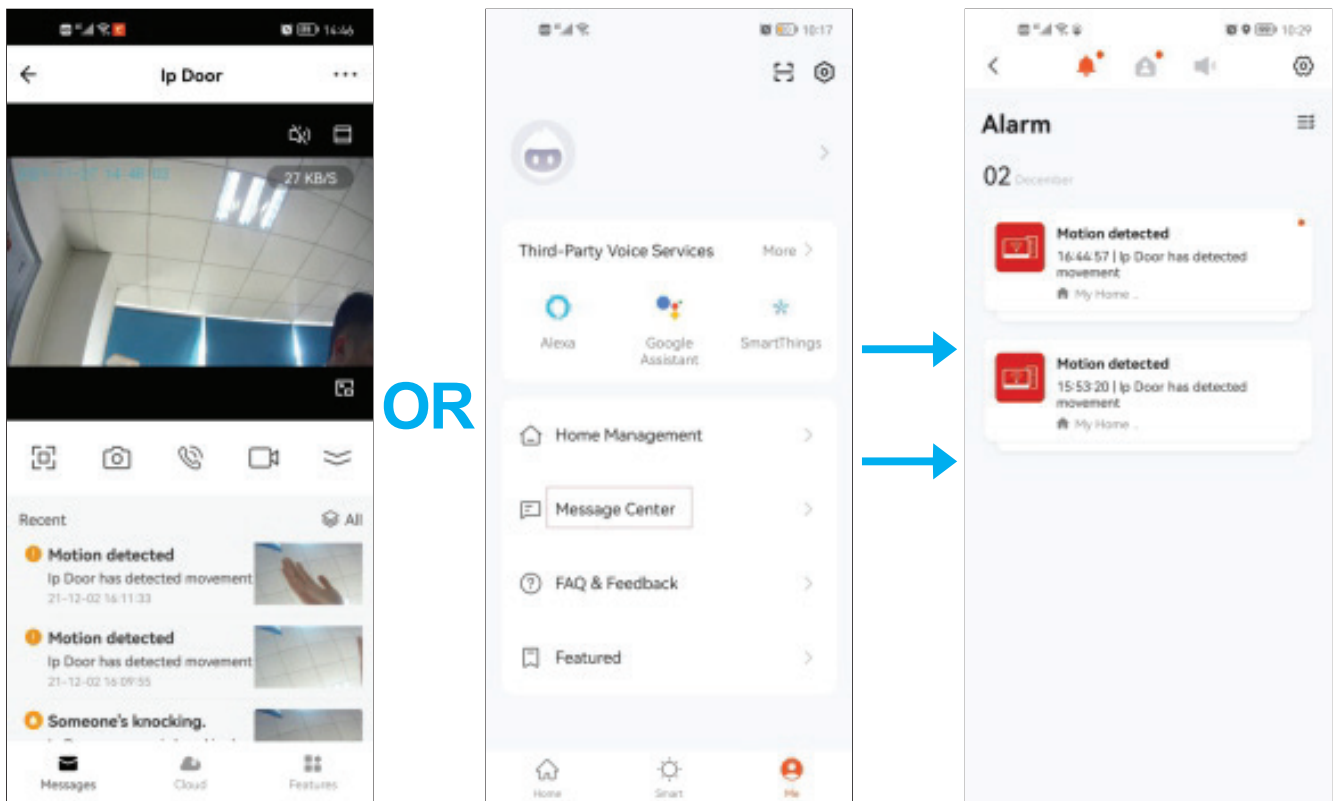

Keypad Operation

Basic Configure:

Function	Keystroke Steps	Notes
Set master code (6 digits only)	* (Master Code) # 0 (New Code) # (Repeat New Code) #	Default Master Code is 123456
Standalone/Controller mode	* (Master Code) # 7 7 #	To put the device back to its default factory working mode
Wiegand reader mode	* (Master Code) # 7 8 #	Wiegand output
Exit	*	Press * to exit programming

Standalone/Controller Mode

Connection Diagram

Common Power Supply

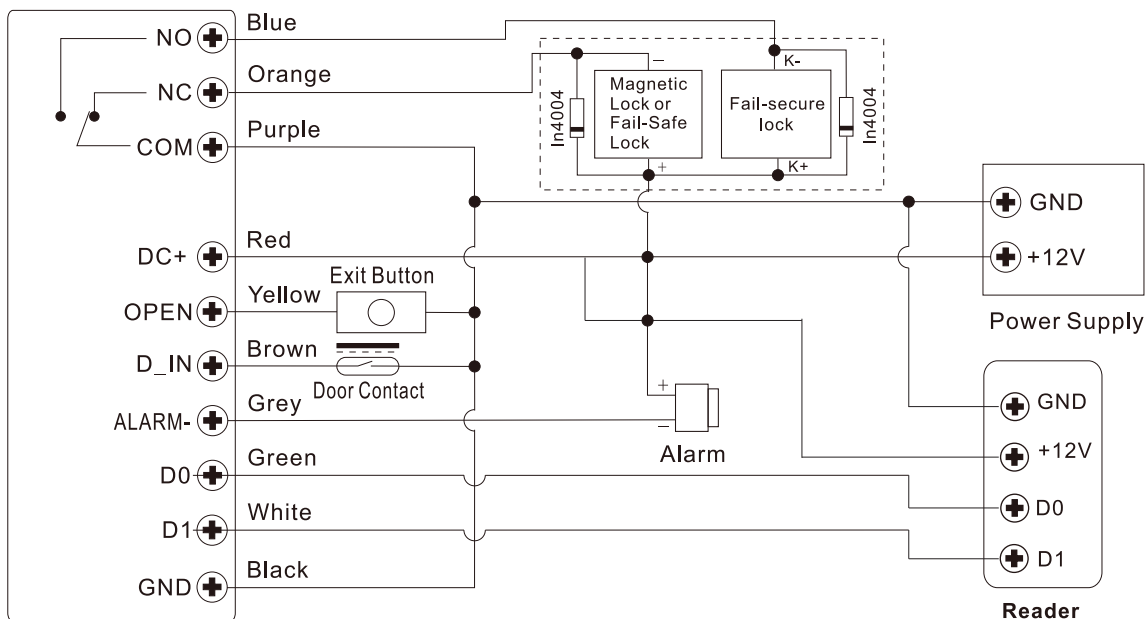

Attention:

Install a 1N4004 or equivalent diode is needed when use a common power supply, or the keypad might be damaged. (1N4004 is included in the packing)

Access Control Power Supply

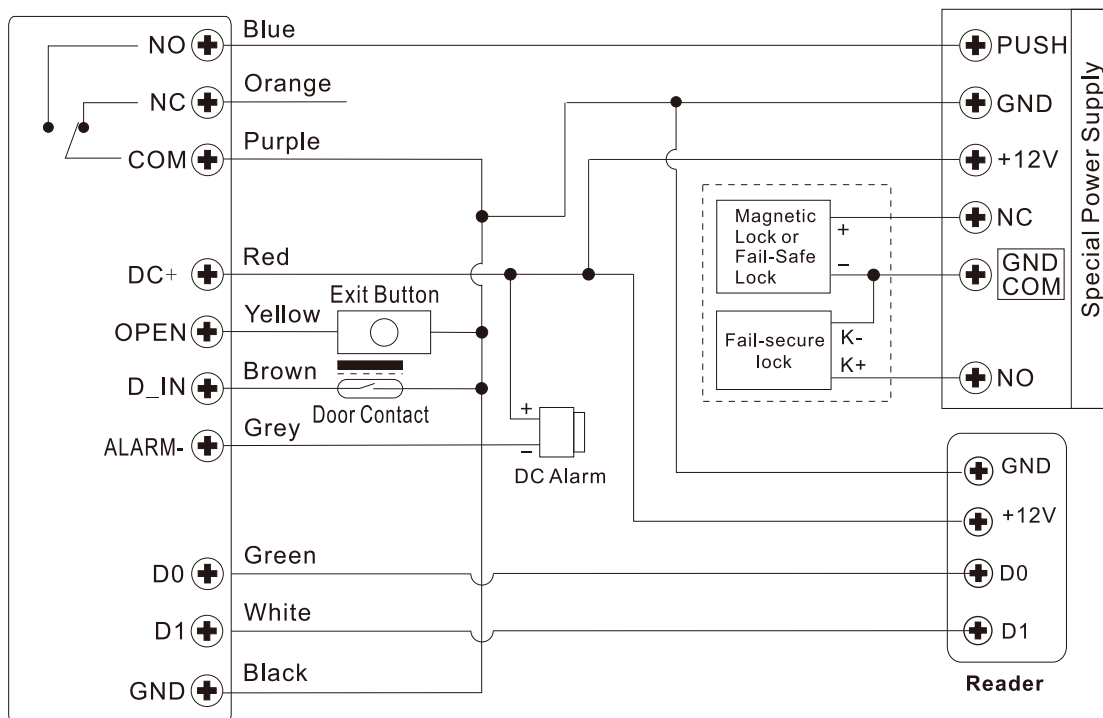

Users Management:

Function	Keystroke Steps	Notes
Add fingerprint user (For fingerprint version)	*(Master Code) # 1 (Fingerprint) (Repeat fingerprint) (Repeat fingerprint again)	Using auto ID, the cards can be added continuously
	*(Master Code) # 1 (User ID) # (Fingerprint) (Repeat fingerprint) (Repeat fingerprint again)	Select specific ID ID number: 0~98 (common fingerprints) 99 (Master fingerprint)
Add common card user	* (Master Code) # 1 (Read card) / (Input 8/10 digits card number) #	Using auto ID, the cards can be added continuously
	* (Master Code) # 1 (User ID) # (Read card) / (Input 8/10 digits card number) #	Select specific ID, ID number: 0~987 100~987(Fingerprint version)
	* (Master Code) # 1 (User ID) # (Card quantity) # (The first card 8/10 digits number) #	Select specific ID, ID number: 0~987 100~987(Fingerprint version)
Add common PIN user	* (Master Code) # 1 (PIN) #	Using auto ID, the PINs can be added continuously
	* (Master Code) # 1 (User ID) # (PIN) #	Select specific ID, ID number: 0~987 100~987(Fingerprint version)
Add panic user	* (Master Code) # 1 (User ID) # (Read card / Input 8/10 digits card number / PIN) #	User ID number is 988,989; PIN length: 4-6 digits except 8888
Add visitor user	* (Master Code) # 1 (User ID) # (0~9) # (Read card / Input 8/10 digits card number / PIN) #	(0~9) means times of usage, 0=10 times, after the certain number of times, the card/PIN become invalid automatically ID number: 990~999
Change PIN	* (User ID) # (Old PIN) # (New PIN) # (Repeat new PIN) #	PIN length: 4-6 digits except 8888
Change PIN of Card + PIN access mode	* (Read card) (Old PIN) # (New PIN) # (Repeat new PIN) #	There will auto allocate PIN (8888) to cards when adding
Delete user	* (Master Code) # 2 (Read card) / (Input fingerprint) / (Input PIN) #	Delete user by card / fingerprint / PIN the users can be deleted continuously
	* (Master Code) # 2 (User ID) #	Delete user by ID number
	* (Master Code) # 2 (Input 8/10 digits card number) #	Delete card user by card number
	* (Master Code) # 2 (Master Code) #	Delete all users
Exit	*	Press * to exit programming

Tips for PIN Security (Only valid for 6 digits PIN):

For higher security we allow you to hide your correct PIN with other numbers up to a max of 10 digits.

Example PIN: 123434

You could use **** (123434) **** or **** (123434)**

("*" can be any numbers from 0~9)

Set Access Mode (for without fingerprint version):

Function	Keystroke Steps	Notes
Card access	* (Master Code) # 4 0 #	Entry by card only
PIN access	* (Master Code) # 4 1 #	Entry by PIN only
Card + PIN access	* (Master Code) # 4 2 #	Entry by card + PIN
Card or PIN access	* (Master Code) # 4 3 #	Entry by card or PIN (default)
Multi user access	* (Master Code) # 4 3 (2~9) #	Only after 2~9 valid users, the door can be opened. The interval time of reading can't exceed 5 seconds
Exit	*	Press * to exit programming

Set Access Mode (for fingerprint version):

Function	Keystroke Steps	Notes
Fingerprint access	* (Master code) # 4 0 #	Entry by fingerprint only
Card access	* (Master code) # 4 1 #	Entry by card only
PIN access	* (Master code) # 4 2 #	Entry by PIN only
Card+PIN access	* (Master code) # 4 3 #	Entry by card+PIN only
Multi users access	* (Master code) # 4 3 (2~9) #	Only after 2~9 valid users, the door can be opened. The interval time of reading can't exceed 5 seconds
Fingerprint or Card or PIN access	* (Master code) # 4 4 #	Entry by fingerprint or card or PIN(default)
Exit	*	Press * to exit programming

Operation Setting:

Function	Keystroke Steps	Notes
Relay time setting	* (Master Code) # 3 (1~99) #	Time range: 1~99s (default is 5 seconds)
Relay toggle mode	* (Master Code) # 3 0 #	Set the relay to ON/OFF toggle mode
Strike-Out OFF	* (Master Code) # 6 0 #	Normal mode (default)
Strike-Out ON	* (Master Code) # 6 1 #	Access will be denied for 10 minutes after 10 failed entry attempts.(Exit button is still workable)
Strike-Out ON (Alarm)	* (Master Code) # 6 2 #	It will alarm after 10 failed entry attempts. Enter any valid card / PIN # (user or master) to silence
Disable door open detection	* (Master Code) # 6 3 #	Normal mode (default)

Enable door open detection(Request to connect magnetic contact)	* (Master Code) # 6 4 #	Door open too long (1 minutes) or door forced open detection. Enter any valid card / PIN # (user or master) to silence
Alarm time	* (Master Code) # 5 (0~3) #	Time range: 0~3 minutes, default is 1 minute
Disable sound	* (Master Code) # 7 0 #	Sound closed
Enable sound	* (Master Code) # 7 1 #	Sound activated (default)
LED always OFF	* (Master Code) # 7 2 #	LED is off under standby
LED always ON	* (Master Code) # 7 3 #	LED is on under standby (default)
Keypad backlit always OFF	* (Master Code) # 7 4 #	Turn off keypad backlit
Keypad backlit always ON	* (Master Code) # 7 5 #	Turn on keypad backlit
Keypad backlit automatic OFF	* (Master Code) # 7 6 #	Automatic off after 20s, it will go ON by pressing any key (this key isn't taken into consideration) (default)
Set Wiegand input	* (Master Code) # 8 (26~44) #	EM version default is 26 bits Mifare version default is 34 bits
Disable parity bits	* (Master Code) # 8 0 #	Disable parity bits
Enable parity bits	* (Master Code) # 8 1 #	Enable parity bits (default)
PIN input bits	* (Master Code) # 8 (4 or 8 or 10) #	4=4 bits, 8=8 bits(ASCII), 10=10 digits virtual number
Exit	*	Press * to exit programming

Note: For connecting Wiegand reader with 32, 40 bits input, need disable parity bits

Master Card/ Fingerprint Usage (Master / User Fingerprints for fingerprint version only)

Add/ Delete Users	
Add Card/ PIN/ Fingerprint Users	<ol style="list-style-type: none"> 1. Input (Master Card/ Fingerprint) 2. Input (Card) or (PIN #) or (Fingerprint) Repeat step 2 for additional users 3. Input (Master Card/ Fingerprint) again
Delete Card/ PIN/ Fingerprint Users	<ol style="list-style-type: none"> 1. Input (Master Card/ Fingerprint) Twice within 5s) 2. Input (Card) or (PIN #) or (Fingerprint) Repeat step 2 for additional users 3. Input (Master Card/ Fingerprint) again

Users Operation & Reset to Factory Default

- > **Open the door:** Read valid user card or input valid user PIN # or input valid user fingerprint (for Fingerprint Version)
- > **Remove Alarm:** Enter Master Code # or Master Card or valid user card / PIN
- > **To reset to factory default & Add Master Card:** Power off, press the Exit Button, hold it and power on, there will be two beeps, then release the exit button, the LED light turns into yellow, then read any 125KHz EM card/13.56MHz Mifare card, the LED will turn into red, means reset to factory default successfully. Of the card reading, it is the Master Card.

Remarks:

- ① If no Master Card added, must press the Exit Button for at least 5 seconds before release. (this will make the previous registered Master Card invalid)
- ② Reset to factory default, the user's information is still retained.

> **To reset the WiFi System:** Power on, press the bell button in 30s, hold it about 5s, until we hear the voice "System Reset", means reset system successfully, then release the button.

Remarks:

Reset the WiFi System can't unbind the device, it must be operated in APP to unbind the device.

Wiegand Reader Mode

Connection Diagram

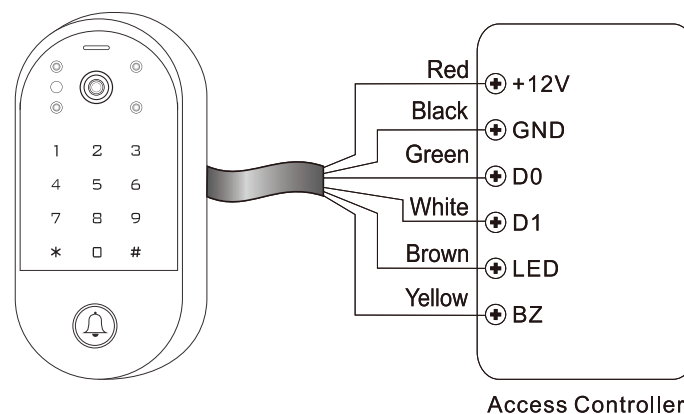

Set Wiegang Output:

Function	Keystroke Steps	Notes
Set Wiegand output	* (Master Code) # 8 (26~44) #	EM version default is 26bits Mifare version default is 34 bits
Disable parity bits	* (Master Code) # 8 0 #	Disable parity bits
Enable parity bits	* (Master Code) # 8 1 #	Enable parity bits (default)
PIN output bits	* (Master Code) # 8 (4 or 8 or 10) #	4=4 bits, 8=8 bits(ASCII), 10=10 digits virtual number
Exit	*	Press * to exit programming

Note: For connecting Wiegand controller with 32, 40 bits input, need disable parity bits

Advanced Application

User Information Transfer (Valid for Card / PIN Users)

The device supports the User Information Transfer function, and the enrolled user (cards, PINs) can be transferred from one (let's name it Master Unit) to another (let's name it Accept Unit).

Connection Diagram:

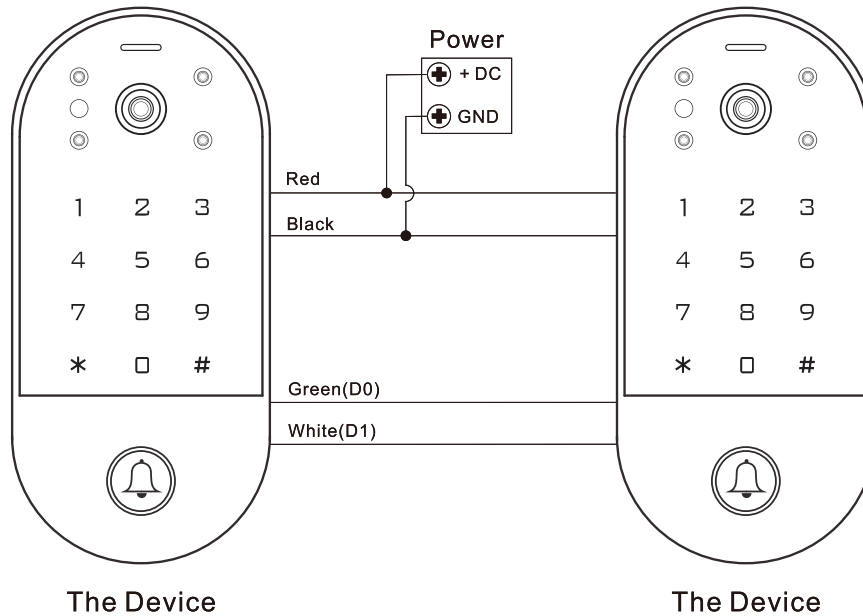

Interlock

Remarks: The Door Contact must be installed and connected as the diagram. Let's name the two Devices as "A" and "B" for two doors "1" and "2"

Connection Diagram:

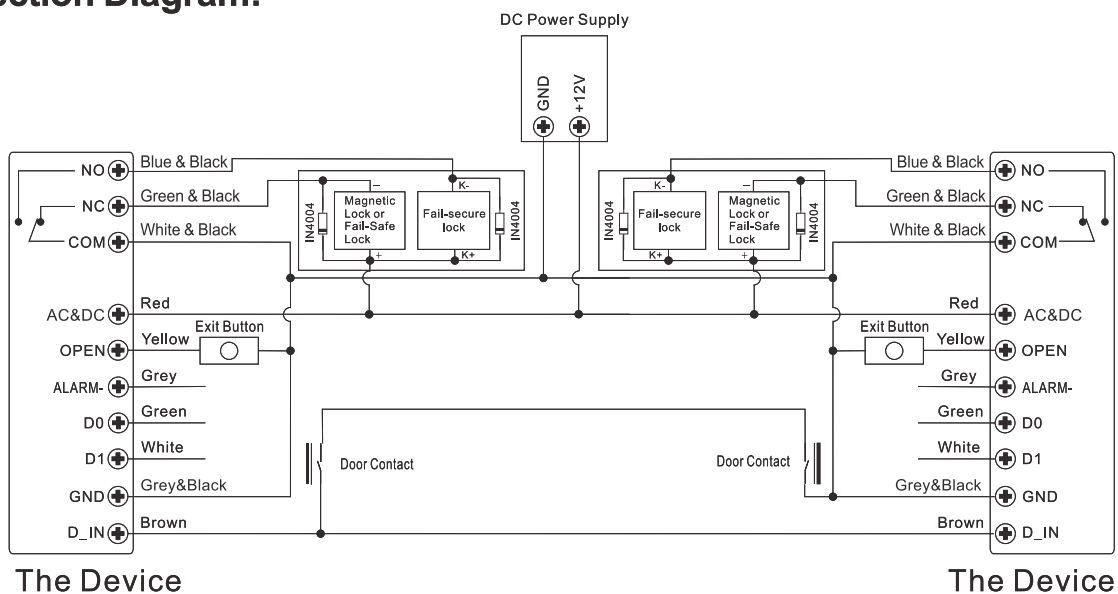

If enable interlock, when and only door 2 is closed, the user can read the valid fingerprint/ card or input PIN on Reader A, door 1 will open; then when and only door 1 closed, read valid fingerprint/card or input PIN on Reader B, door 2 will open.

Advanced Setting:

Function	Keystroke Steps	Notes
Transfer users	* (Master Code) # 9 8 #	The master code of two devices must be same. Program on Master Units only.
Disable interlock	* (Master Code) # 9 0 #	Disable interlock (default)
Enable interlock	* (Master Code) # 9 1 #	The users in two devices must completed same
Exit	*	Press * to exit programming

Simplified Instruction	
Function Description	Operation
Enter the Programming Mode	* - Master Code - # then you can do the programming (123456 is the factory default master code)
Change the Master Code	0 - New Code - # - Repeat the New Code - # (code: 6 digits)
Add Card User	1 - Read Card - # (can add cards continuously)
Add Fingerprint User (Fingerprint version only)	1-Fingerprint- Repeat Fingerprint- Repeat Fingerprint Again- #
Add PIN User	1 - PIN - # (The PIN is any 4~6 digits except 8888 which is reserved)
Delete User	2- Fingerprint- # (Fingerprint version only) 2-Read Card- # 2-PIN- #
Exit from the Programming Mode	*
How to release the door	
Fingerprint User (Fingerprint version only)	Input Fingerprint
Card User	Read Card
PIN User	Input PIN #