



**GLOBAL**  
FIRE EQUIPMENT

# **JUNO-NET**

**EN-54**

Fire Alarm Control Panel

# **INSTALLATION & COMMISSIONING MANUAL**

## OVERVIEW

Introduction.....	6
EN-54 Information and Key Features.....	7
Typical System Schematic.....	8
Typical System Block Diagram.....	9
Power Requirements.....	10
Battery Requirements.....	11
Identifying Components.....	12
Recommended Cables.....	18
Analogue Loops, Conventional Sounders and Data Loops.....	18
Limitations.....	18
Definitions.....	19

## INSTALLATION

Introduction.....	21
Main Panel.....	21
Mains Power Connection.....	21
Other Main Panel connections.....	21
Integrated Sub-panels.....	21
Repeaters.....	23
Mains Power Connection.....	23
Integrated Sub-panels.....	23
Standard Sub-panels.....	24
Data Loops.....	25
Main Panel RS485.....	26
Data Loop Interface Configuration.....	27
Repeater RS485.....	28
Standard Sub-panel RS485.....	29
RS485 External Connection.....	30
Connection Schematic for Self-Contained Panels.....	31
Connection Schematic for Main Panel to External Sub-Panel(s).....	32
Connection Schematic for Main Panel to External Sub-Panel(s) using RS485.....	33
Connection Schematic for Panel, Repeater and Sub-Panel using Fibre Optics.....	34
Connection Schematic for Main Panel to Repeater Panel(s) using RS485.....	35
Main Panel Fibre Optic.....	36
Repeater Fibre Optic.....	36
Fibre Optic External Connection.....	37
Analogue Loops.....	38
Conventional Sounders.....	40
Fire Relays.....	41
Relay Drive Outputs.....	41
Fire Brigade Transmission.....	42
Printer.....	43
Main Panel Batteries.....	44
Sub-panel Batteries.....	45
PC Graphics Software.....	46

**COMMISSIONING**

Introduction..... 47

The Main Panel Buttons..... 47

Getting The Main Panel Running..... 51

Getting A Repeater Running..... 51

Getting A Standard Sub-panel Running..... 52

Setting Panel Addresses And Types..... 53

    Main Panel Integrated Sub-panel..... 53

    Repeater Integrated Sub-panel..... 53

    Standard Sub-panels..... 54

Getting Into Programming Mode..... 55

    Connecting a PS2 Keyboard to the Main Panel..... 56

    The IR Keypad Keys..... 57

    Help..... 57

    Logging In..... 58

    Function Selection..... 58

Getting The System Running..... 59

    Communications Check..... 59

    Main Panel Check..... 59

    Learning Which Devices Are Fitted..... 60

    Sounder Audibility Check..... 61

        Main Panel..... 61

        Standard Sub-panels..... 61

        Integrated Sub-panels..... 61

    Analogue Loop Monitoring..... 62

        Open Circuit Test..... 62

        Short Circuit Test..... 62

    Conventional Sounder Monitoring..... 63

    Detector Tests..... 64

        Detector Tests By Zone..... 64

        Unassigned Detector Test..... 64

Wrapping Up Installation And Commissioning..... 65

    Battery Fault Message Test..... 66

    Power Failure Test..... 67

Master Reset..... 68

**ADVANCED FUNCTIONALITY**

Programming Functions General..... 69

    Complete List Of Functions..... 69

    Keys To Use Within Functions..... 72

    Help..... 72

    QUART..... 72

    General..... 73

**Specific Functions**

<b><u>1 Review Historic Log</u></b> .....	<b>74</b>
1-1 Display Historic Log.....	74
1-2 Print Historic Log Entries.....	74
1-3 Clear Historic Log.....	74
1-4 Print Loop/Device Set-up.....	74
1-5 Read/Clear Autostart Count.....	74
<b><u>2 Text Descriptions &amp; Names</u></b> .....	<b>75</b>
2-1 Enter Device Text.....	75
2-2 Enter Zone Text.....	75
2-3 Enter Company Name.....	75
<b><u>3 Zones - Disable &amp; Assign</u></b> .....	<b>76</b>
3-1 Disable Zones.....	76
3-2 Assign Sounder Groups to Zones.....	76
3-3 Assign I/O Groups to Zones.....	76
3-4 Assign Zone to Device.....	76
3-5 Zone Sounder Delay Set-up.....	76
3-6 Zone Fire Brigade Delay Set-up.....	77
3-7 Set BMS Zone Numbers.....	77
<b><u>4 Sounders - Disable &amp; Assign</u></b> .....	<b>78</b>
4-1 Sounder Configuration.....	78
4-2 Configure Sounder Groups.....	78
4-3 Disable Sounders.....	79
4-4 Assign Sounder Group to Device.....	79
4-5 Inhibit Sounders for Device.....	79
4-6 Sounder Delay Set-up.....	80
4-7 Override Sounder Delays.....	80
<b><u>5 Input/Output - Disable &amp; Assign</u></b> .....	<b>81</b>
5-1 Configure I/O Groups.....	81
5-2 Select Fault I/O Group.....	81
5-3 Assign I/O Group to Device.....	82
5-4 Inhibit I/O for Device.....	82
5-5 I/O Unit Action upon Evacuate.....	82
5-6 I/O Unit Delay or Immediate.....	82
5-7 I/O Delay Set-up.....	82

<b>6 Device Set-up</b> .....	<b>83</b>
6-1 General.....	83
6-1-1 Disable Loops .....	83
6-1-2 Device Disable.....	83
6-1-3 Set Selective Disablement.....	83
6-1-4 Set Device Reporting Details.....	84
6-1-5 Set Immediate Evacuate for Device.....	84
6-1-6 Device Activation Overrides Delays.....	84
6-1-7 Inhibit Auxiliary Relays.....	84
6-1-8 Global Sensitivity Set-up.....	85
6-1-9 Configure Timed Sensitivity.....	85
6-2 Other device options.....	86
6-2-1 Select Device Heat Grade.....	86
6-2-2 Select Device Smoke Sensitivity.....	86
6-3 <b>Removed - No longer available</b>	
6-4 Automatic Address Setting (SAM).....	87
6-4-1 Activate ASET Mode (SAM).....	88
6-4-2 Clear Loop.....	89
6-4-3 Clear Device.....	89
Trouble shooting SAM.....	90
<b>7 Monitor Device Counts &amp; Test</b> .....	<b>91</b>
7-1 Device Count, Type & Value.....	91
7-2 Test Sounders.....	91
7-3 Sounders on Test Activation.....	92
7-4 Test Zones.....	92
7-5 Sub-Panel LED Test.....	92
7-6 Light LED on device.....	92

<b>8 General</b> .....	<b>93</b>
8-1 Time/Date & Timers.....	93
8-1-1 Set Date & Time.....	93
8-1-2 Define Day & Night.....	93
8-1-3 Delays Off at Night.....	93
8-1-4 Configure Evacuate Timer.....	94
8-1-5 Device Starts Evacuate Timer.....	94
8-1-6 Fire Brigade Delay Set-up.....	95
8-2 Special Features Set-up.....	96
8-2-1 Two Devices to Evacuate.....	96
8-2-2 Call Points to Evacuate.....	96
8-3 Memory - BEWARE, ENGINEERS ONLY.....	97
8-3-1 Clear Customer Flash Memory.....	97
8-3-2 Clear Non-Volatile RAM.....	98
8-3-3 Calculate Customer Flash Checksum.....	98
8-3-4 Calculate Program Flash Checksum.....	98
8-4 Other Features.....	99
8-4-1 Active/Installation Mode.....	99
8-4-2 Upload/Download Link to PC.....	99
The PC Loader Software.....	100
The PC JUNO Download Utility.....	100
The Main Panel.....	100
Uploading/Downloading Customer Site Data.....	101
8-4-3 Printer Disable/Enable.....	102
8-4-4 Set User Access Code.....	102
8-4-5 Set User Access Facilities.....	102
8-4-6 Select language.....	102
8-4-7 <b>Removed - No longer available.</b> .....	103
8-4-8 Set Installer Access Code.....	103
8-5 Remote Access and Monitoring.....	104
8-5-1 Configure PC Graphics Interface.....	104
8-5-2 Modem Dial Out Number.....	104
How The Dial Out Works.....	105
8-5-3 Modem Initialization String.....	105
<b>TECHNICAL SPECIFICATIONS</b> .....	<b>106</b>
Main Panel.....	107
Repeater.....	107
Standard Sub-panel.....	107
<b>CE DECLARATION OF CONFORMITY</b> .....	<b>108</b>

## Introduction

This document covers the installation and commissioning of a JUNO-NET fire alarm system. This document is intended for use by a competent, qualified, fire alarm installation engineer.

The JUNO-NET fire alarm system is highly modular and each system should be tailored to the building requirements. The complete system should be designed to meet all applicable regulations. The installation must then be performed in accordance with the system design. This manual not only clarifies the components and connections during installation but will also assist in commissioning and maintenance.

This manual covers the installation and commissioning of a complete system. There is a separate Operation and Maintenance Manual.



ELECTRO-STATIC SENSITIVE DEVICES (ESD)  
TAKE SUITABLE ESD PRECAUTIONS WHEN REMOVING OR  
INSTALLING PRINTED CIRCUIT BOARDS.

All PCBs contain Electrostatic Sensitive Devices.

Take suitable ESD (Electrostatic Discharge) precautions when removing or installing printed circuit boards (PCBs).

## EN-54 Information

In accordance with EN54 pt.2 1997 / AC: 1999, clause 13.7, the maximum number of sensors and/or manual call points in this panel, will not exceed 512 units.

This fire Detection Control Panel complies with the requirements of EN54 pt. 2 and 4 1997 / AC: 1999. In addition to the requirements of the above mentioned standard, the unit conforms to the following optional functions:

<b>OPTION</b>	<b>EN54 pt.2 Clause</b>
<b>Indication</b>	Fault Signals from points 8.3
<b>Controls</b>	Delays for activation of outputs 7.11
	Disablement of each addressable point 9.5
	Test Condition 10
<b>Outputs</b>	Outputs to fire alarm devices 7.8

In addition to the functions required by the standard EN54 pt. 2 1997 / AC: 1999, the panel supports ancillary functions that are not required by the above mentioned standard, namely:

### **Ancillary Functions:**

Panel network connection ports.

Panel to PC graphics software output port.

Panel to PC programming software (upload/download) port.

Remote class change input extension board connector.

Internal and External Printer.

Auxiliary relays outputs.

### **Key Features**

- Fully expandable system - from 1 to 96 loops
- 125 device addresses per loop
- 96 VULCAN (addressable) ultra low current base sounders per loop (32 address limit)
- 32 individually programmable sounder addresses per loop
- Full SAM and MAM support - Wizmart protocol only
- 2 Fire output relays (change-over) and 1 Fault relay (Normally Closed)
- Open collector outputs for Fire, Fault and Pre-alarm remote indicators
- 2 conventional alarm outputs on each Main Panel, Repeater and Sub-panel (Individually programmable)
- Repeaters with optional Integrated Sub-panels (with one or three loops)
- All detector loops monitored for integrity
- 384 fully programmable zones
- 512 fully programmable sounder groups
- 512 Input and Output groups
- Event log (rolling, 2000 entries)
- Compatible with Apollo S90™/XP95™, Discovery™, Wizmart and Hochiki ESP Protocols
- Compatible with all our own low cost ancillary modules
- Backlit LCD display with 4 rows of 40 characters
- Programming by panel keypad, infra-red remote keypad, PC keyboard and Windows™ based "Loader" software
- Windows™ based PC graphics software for alarm management and reporting
- Multiple language support (menu selectable)
- BMS output (RS232) (optional)
- Evacuate/Class Change input (optional)
- Multi-panel network by RS485 or fibre optic links
- Optional internal 40 column thermal printer
- Discovery functions: Only Apollo protocol
- Optional fire and fault LED zone indication



**Typical System Schematic**

**J-NET-CON**

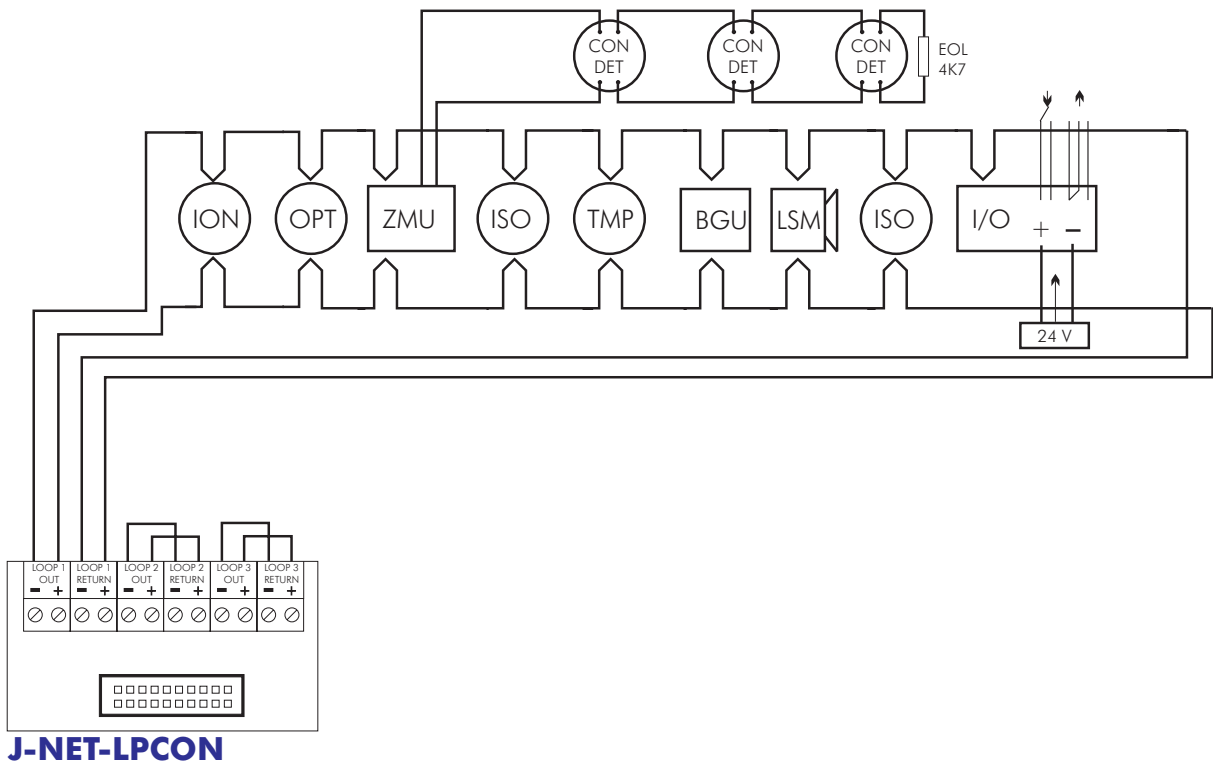
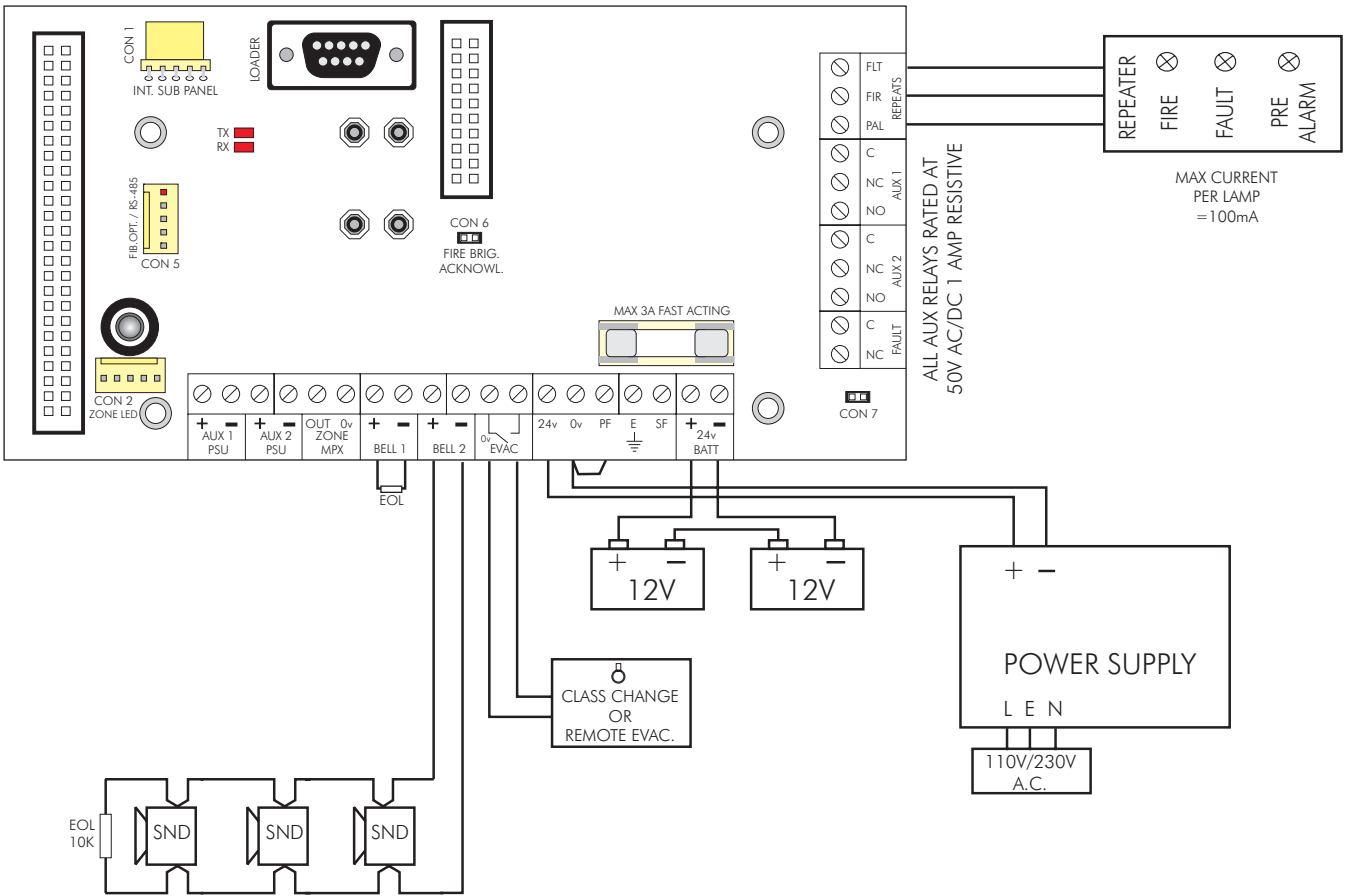

**Typical System Block Diagram**

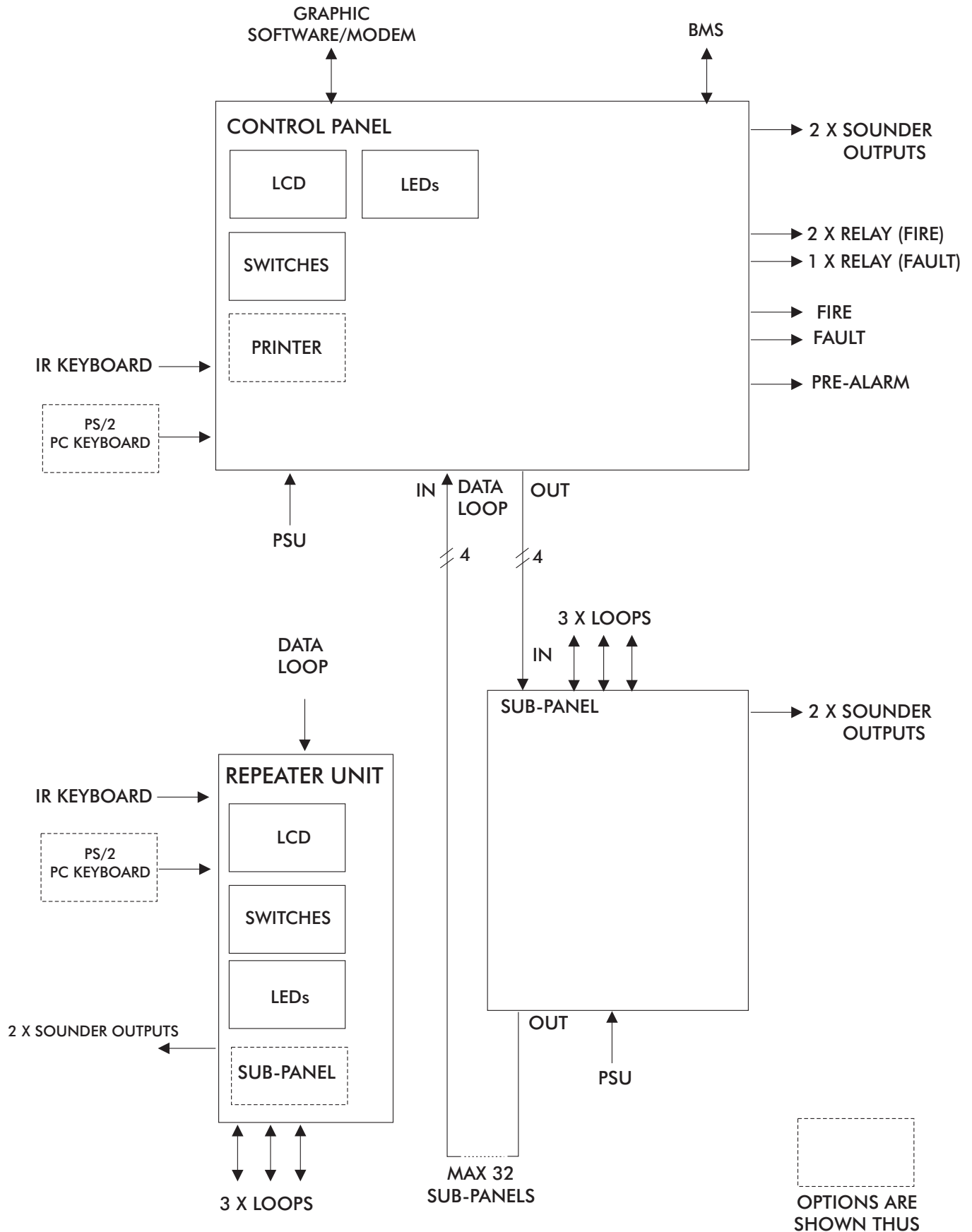

## Power Requirements

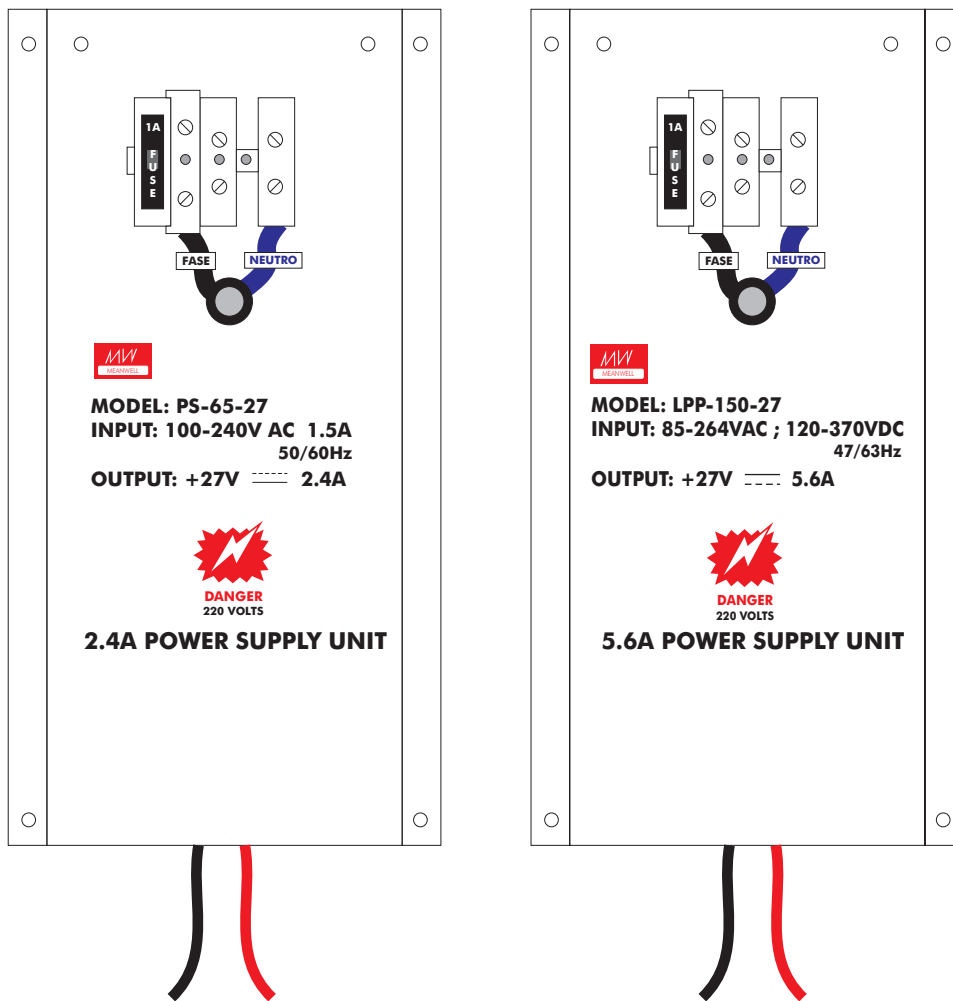

### Voltage

Primary supply voltage  
 EMC Standard

85 - 264 VAC  
 EN55022 class B  
 EN61000-4-2,3,4,5,6,8,11  
 EN61000-3-2,3

### Current

2.4A PSU's recommended for 1 or 3 loop stand-alone or networked panels.  
 5.6A PSU's recommended for up to 9 loop self-contained or networked panels.

The maximum alarm sounder current is the power supply current (2.4A or 5.6A) less the panel's alarm current.

The maximum quiescent current per loop is 250mA. The loop short circuit (trip) current is 900mA.

### Battery

Internal maximum 24V / 12AH

## Battery Requirements

The battery AH required are calculated from the following formula

$$\left( \begin{array}{l} \text{Quiescent current in mA of} \\ \text{the panel with everything} \\ \text{connected.} \end{array} \times \begin{array}{l} \text{Standby time required in} \\ \text{hours divided by 1000.} \end{array} \right) +$$

$$\left( \begin{array}{l} \text{Alarm current in Amps} \\ \text{(sounder load)} \end{array} \times \begin{array}{l} \text{Alarm time in hours} \end{array} \right) + 20\%$$

Round up to the next available battery size.

Quiescent currents for individual equipments are listed below:

EQUIPMENT	QUIESCENT CURRENT (mA)	ALARM CURRENT (mA)
Main Panel	130	150
3 loop sub-panel	76	105
Device on loop	Refer to manufacturer's data	
24V auxiliary outputs (2 off)	Refer to connected devices	

### Example

A given installation has a 6 loop panel with 58mA detector load, 1.4A sounder load (including loop sounders) and a 24 hour standby requirement.

$$\left( \begin{array}{l} \text{Quiescent current in} \\ \text{mA of the panel with} \\ \text{everything connected.} \end{array} \times \begin{array}{l} \text{Standby time} \\ \text{required in hours} \\ \text{divided by 1000.} \end{array} \right) + \left( \begin{array}{l} \text{Alarm current in Amps} \\ \text{(sounder load)} \end{array} \times \begin{array}{l} \text{Alarm time in} \\ \text{hours} \end{array} \right) + 20\%$$
  

$\begin{array}{r} 130 \text{ (main panel)} \\ + \\ 2 \times 76 \text{ (6 loops)} \\ + \\ 58 \text{ (detector load)} \\ \hline \end{array}$	$\begin{array}{r} 24 \text{ (standby in hrs)} \\ \text{divided by} \\ 1000 \\ \hline \end{array}$	$\begin{array}{r} 150 \text{ (main panel)} \\ + \\ 2 \times 105 \text{ (6 loops)} \\ + \\ 58 \text{ (detector load)} \\ \hline \end{array}$	$\begin{array}{r} 0.5 \\ \text{(alarm time in hrs)} \\ \hline \end{array}$
$\downarrow$	$\downarrow$	$\downarrow$	$\downarrow$
$\left( \begin{array}{l} \mathbf{340mA} \\ \hline \end{array} \times \begin{array}{l} \mathbf{0.024H} \\ \hline \end{array} \right) = \mathbf{8.16AH}$		$\left( \begin{array}{l} \mathbf{1.818A} \\ \hline \end{array} \times \begin{array}{l} \mathbf{0.5H} \\ \hline \end{array} \right) = \mathbf{0.909AH}$	
$+ \quad +$			
$= \mathbf{9.069 AH + 20\% (1.81AH) = 10.88 AH}$			
<p>The next available battery size is 12AH</p>			

## **Identifying Components**

Panel boxes for Main Panels or Repeaters

### **JUNO-NET Panel Box for 4 to 12 Loops**

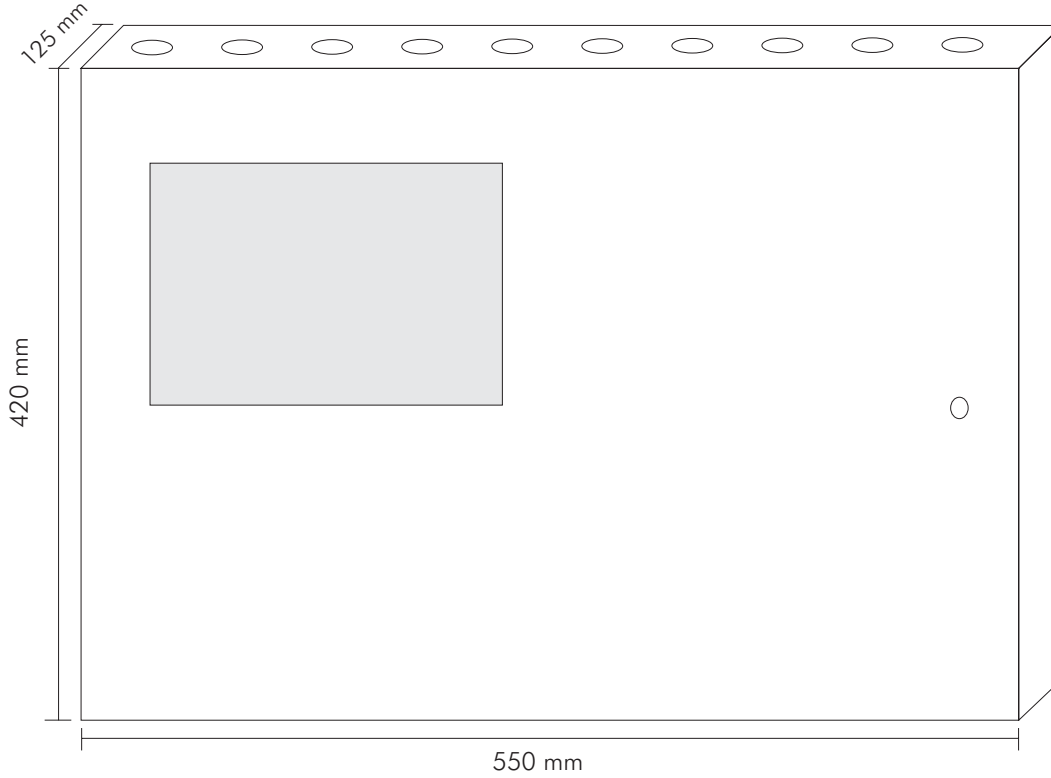

### **JUNO-NET Panel Box for 1 to 3 Loops**

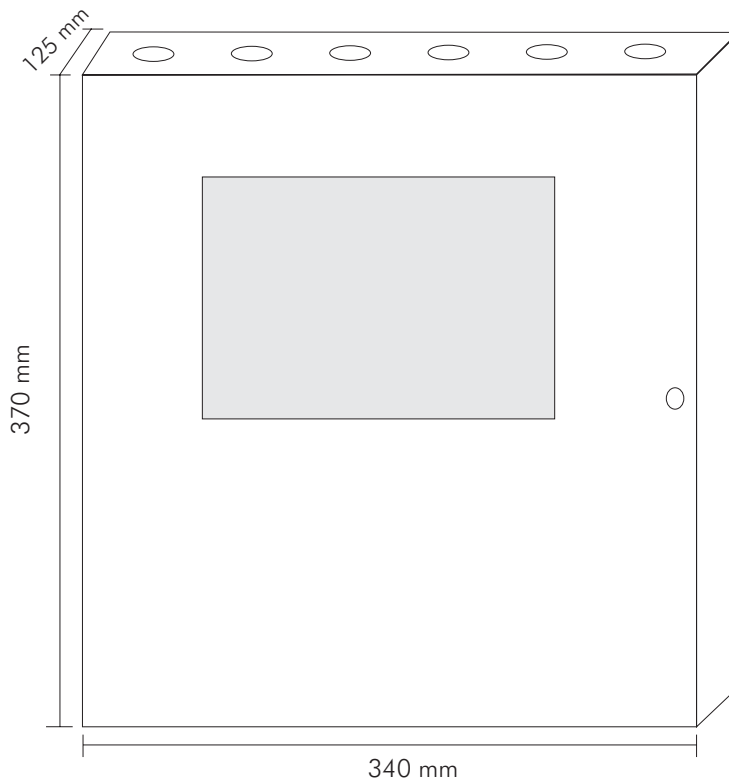

## Identifying Components

Panel boxes for Main Panels or Repeaters

### Inside a 1 to 12 Loop Self-Contained Panel Box

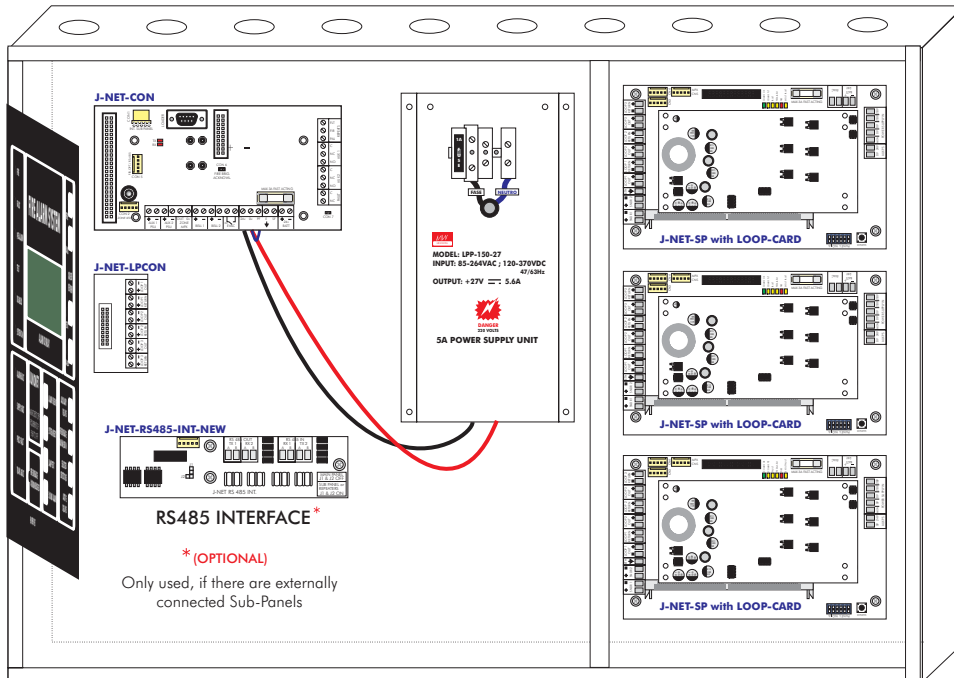

On both of these panels, the first 1 or 3 loops are found on the mainboard that is attached to the metallic fascia of the panel.

### Inside a 1 to 3 Loop Panel Box

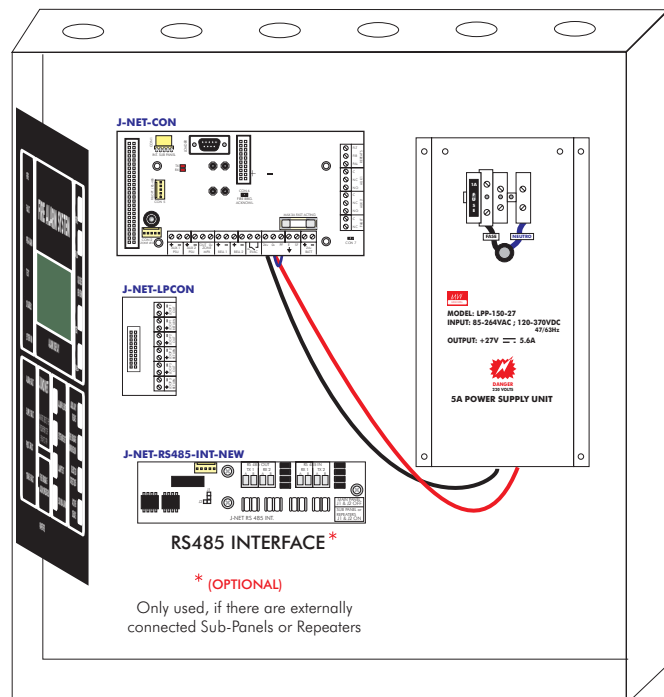

## Identifying Components

Panel box for Sub-Panels

### Inside a Sub-Panel Box

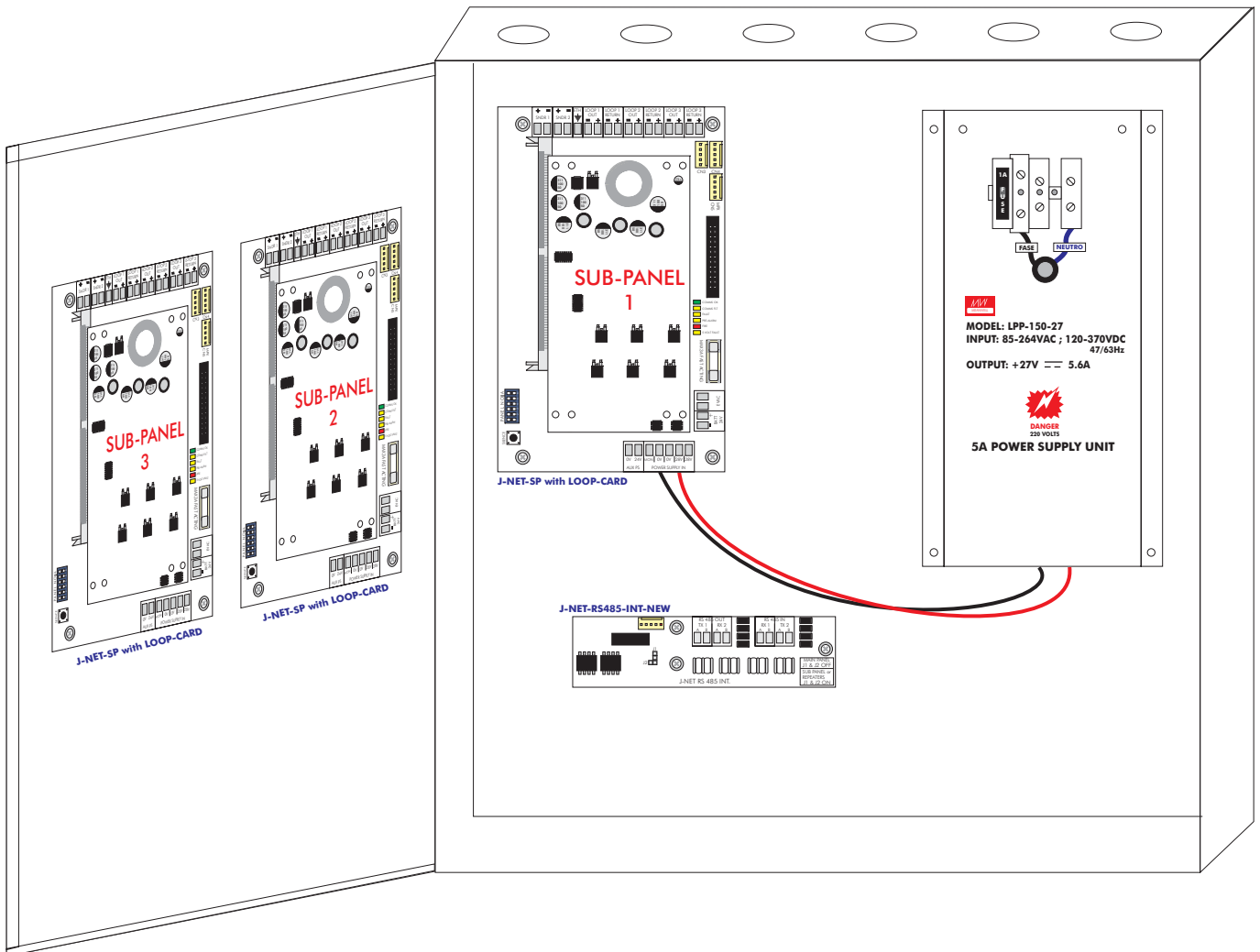





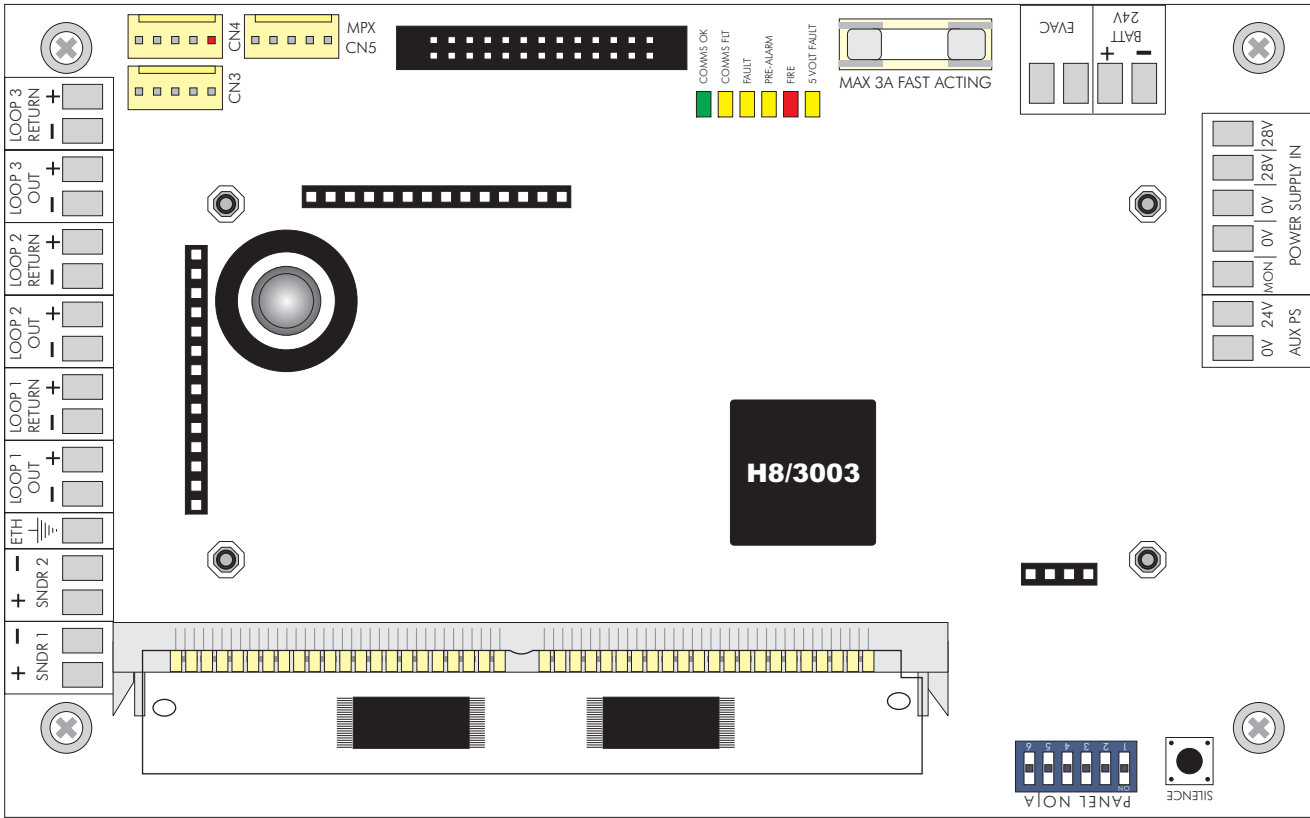

**J-NET-SP:**  
**JUNO-NET**  
**SUB-PANEL BOARD**

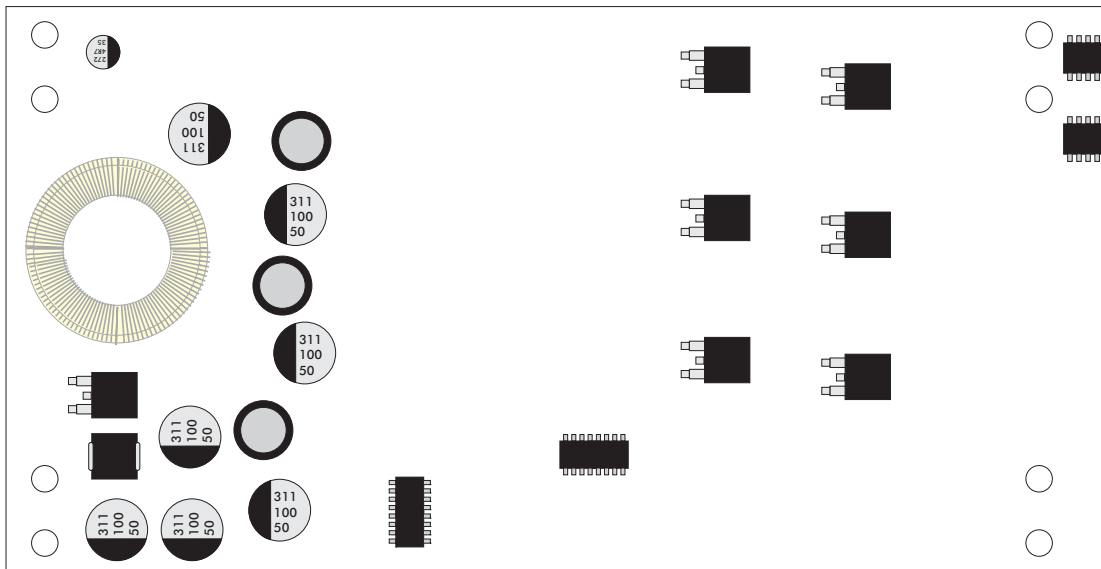

**1-LC or 3-LC**  
**1 LOOP CARD or 3 LOOP CARD**

**JUNO-NET MOTHERBOARD (BACK VIEW)**

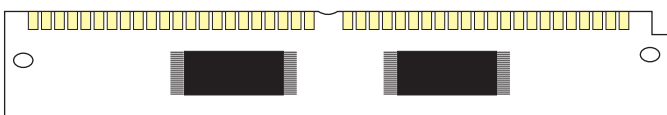
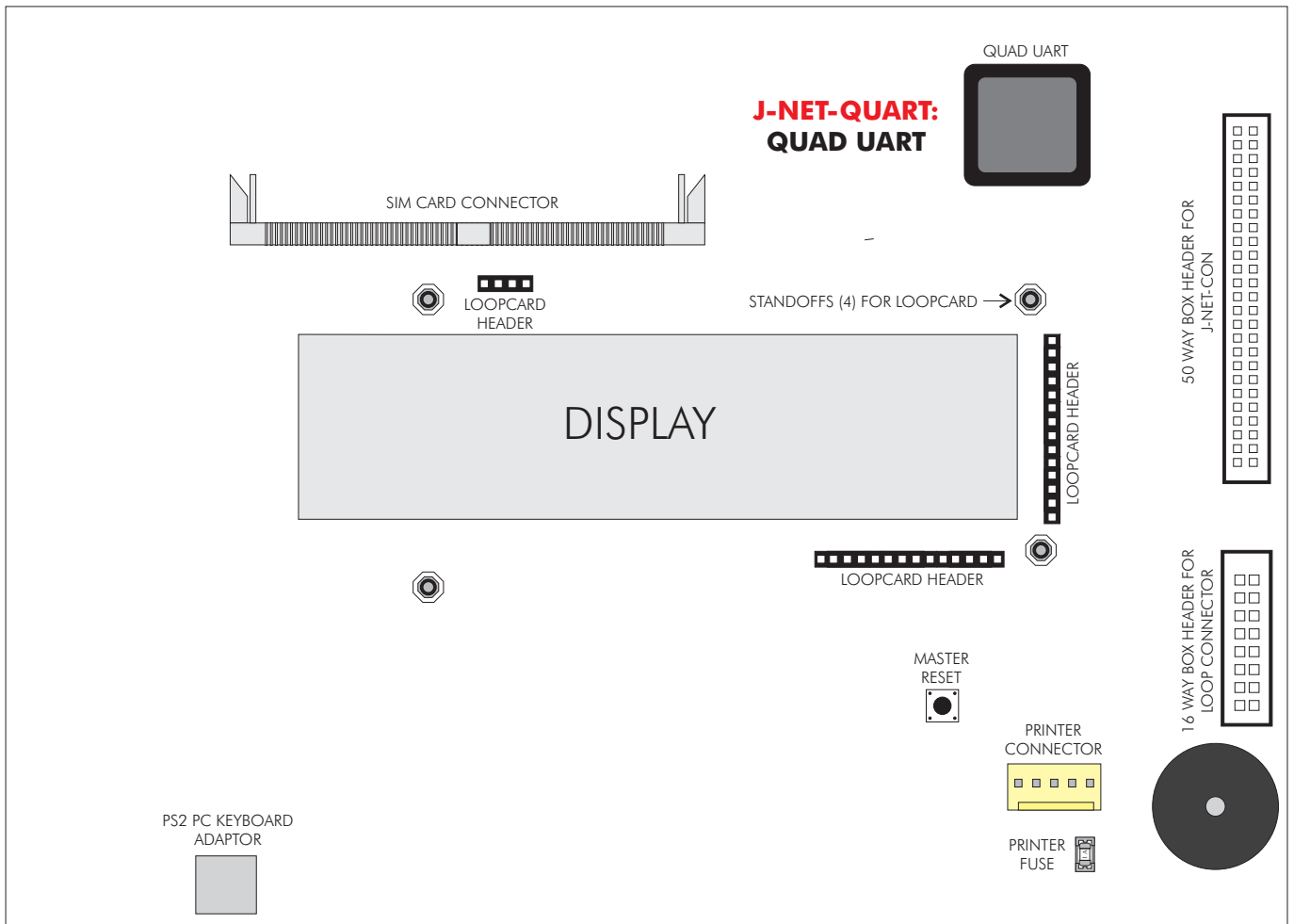

**J-NET-SIM:  
JUNO-NET  
SIM CARD**

**Typical cable form (one end)**

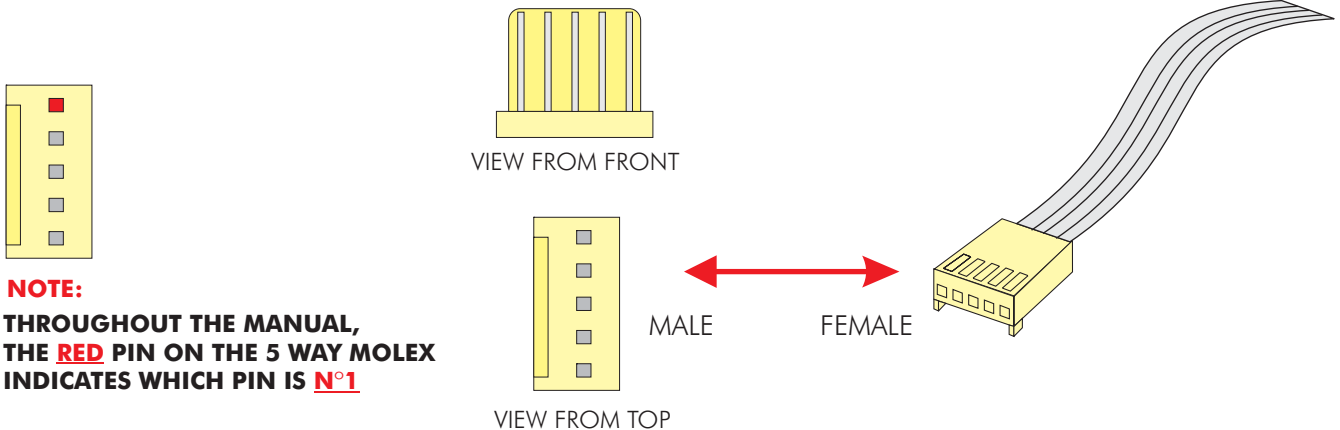

**NOTE:**  
THROUGHOUT THE MANUAL,  
THE **RED** PIN ON THE 5 WAY MOLEX  
INDICATES WHICH PIN IS **Nº1**

## **Recommended Cables**

### Analogue Loops, Conventional Sounders and Data Loops

The JUNO-NET can be installed as either a self-contained or a distributed system. The self contained system does not require external data loop connections. The distributed system requires a 4-core data loop cable for connection to remote sub-panels and Repeaters. The data loop connects the Main Panel to the first Sub-panel and then to the second Sub-panel, etc., and eventually returns to the Main Panel.

### Fire rated Cables for Loops and Sounder Circuits

AEI type Firetec Multicore Ref. F1C1 (1 mm<sup>2</sup>) to F1C2.5 (2.5 mm<sup>2</sup>) in 2 core  
AEI type Firetec Armoured Ref. F2C1 (1.5 mm<sup>2</sup>) to F2C2.5 (2.5 mm<sup>2</sup>) in 2 core  
AEI type Mineral Insulated Cable (all types up to 2.5 mm<sup>2</sup>)  
BICC types Mineral Insulated twin twisted conductor cables, Ref. CCM2T1RG and CCM2T1.5 RG  
BICC types Mineral Insulated Pyrotenax (all types up to 2.5 mm<sup>2</sup>)  
CALFLEX type Calflam CWZ 2 core type up to 2.5 mm<sup>2</sup>  
PIRELLI type FP200 Gold 2 core type from 1 mm<sup>2</sup> to 2.5 mm<sup>2</sup>  
FIRETUF (OHLS) FTZ up to 2.5 mm<sup>2</sup>. Manufactured by Draka

All cables should be screened.

Minimum detection loop conductor section size is 0.5 sq.mm

Maximum detection loop conductor section size is 2.5 sq.mm

There should only be one analogue detector loop per shielded cable.

Analogue detector loops and conventional sounders should not run in the same shielded cable.

If the system requires one or more repeaters, it will be necessary to use a four core data cable to create a data loop between the panel and the repeater. Alternatively, it is possible to use multi-mode dual-core fibre-optic cable or a TCP/IP connection for the same purpose.

Data loop cable should be RS422/485 grade data cable, eg:

### Signal cables for RS485 Communication Links (twisted pair) to Repeater panels

12 AWG Signal 88202 Belden 9583 WPW999  
14 AWG Signal 88402 Belden 9581 WPW995  
16 AWG Signal 88602 Belden 9575 WPW991  
18 AWG Signal 88802 Belden 9574 WPW975  
FIRETUF FDZ1000 by Draka 2 core  
PIRELLI type FP200 Gold 2 core  
PIRELLI type FP-PLUS

Fibre Optic: Multi.mode Dual Core sheathed fire proff with 62,5µ/125µ fibre terminated in ST connectors

## **Limitations**

A fire alarm system can provide early warning of a developing fire but it does not assure protection against damage or loss resulting from a fire.

The fire alarm system should be designed and installed in accordance with all relevant regulations and codes of practice.

To ensure maximum protection the system should be regularly tested and inspected by qualified fire alarm installation personnel. Inspection and testing should be carried out in accordance with the appropriate local standards.

## **Definitions**

### Analogue Loop

The physical link, usually fireproof 2 conductor shielded wiring cable, forming a ring of interconnection between sensors and the detection panel.

### Cable form

A connecting lead. Typically a length of flat cable with connectors at both ends.

### Conventional Sounder

A Conventional Sounder is an audible output device that is connected to the Conventional Sounder outputs on a Main Panel or Sub-panel. It is different electrically to a Loop powered Sounder.

### Data Loop

This may take the form of RS485 or a fibre optic link. It provides communications between the Main Panel and Repeaters or Sub-panels.

### Detector

Any type of fire sensor (heat, smoke) that is connected to an Analogue Loop.

### Device

A detector, sounder, interface module or call-point connected to an Analogue Loop.

### Evacuate

A system state where all sounders are activated simultaneously. Pressing SOUND ALARMS will generate an evacuate condition.

### Fibre Optic Link

A connection method for data that uses light instead of electrical signals. The connection is made using fibre optic cables rather than copper electrical cables. Fibre optic signals can travel far greater distances than electrical signals with less risk of electromagnetic interference.

### Flash

Non-volatile memory inside the panel used to store the program and the customer site data. Flash data storage is very robust and needs no power at all to retain the data.

### Integrated Sub-panel (ISP)

A Main Panel or Repeater can have an Integrated Sub-panel. This is a single sub-panel that can support one or three Analogue Loops.

### Local Sounder

A local conventional sounder is an audible output device (bell or sounder) that is connected to the local bell output on a main or sub panel.

### Loop Sounder

The term Loop Sounder is used to describe an audible output device that is connected to and controlled individually by an Analogue Loop. Loop Sounders are different electrically from Conventional Sounders.

### Main Panel

An installation only has one, and **one** only, Main Panel. This is the heart of the system, which monitors and controls all the components in the system, although not always directly.

### NVRAM

Non-volatile Random Access Memory. Any information stored in this memory will not be cleared when power is removed from the system. The system has an internal battery for the NVRAM.

### PCB

Printed Circuit Board.

### Repeater

A Repeater is a remote terminal to the Main Panel. Everything that is displayed on the Main Panel is also displayed on the Repeater. Any LEDs illuminated on the Main Panel are illuminated on the Repeater. Key presses and programming input at the Repeater are sent directly to the Main Panel, as if the input were actually occurring at the Main Panel.

### SIM CARD

Single In-line Memory Card. Fitted to the SIM CARD is the Flash memory that contains the Main Panel software and the system settings (Customer Flash Memory ).

### Sub-panel

These provide the Analogue Loops. Each Sub-panel supports one or three Analogue Loops. There are two types of Sub-panels: Integrated and Standard. An integrated sub-panel consists of a loop card installed onto either the Main panel or Repeater Motherboard. A standard Sub-panel consists of a loop card installed on a Sub-panel board which is a basic fire control panel with its own CPU, local memory and fire signaling outputs. The Sub-panel reports all events to the main panel but can operate individually in the event of communication loss. Up to 3 standard Sub-panels can be housed within a Main Panel box. Additional Standard Sub-panels can be housed externally , and typically, will be distributed around the building.

Sub-panels are connected to the Main Panel via the Data Loop.

### The System

The Main Panel, Sub-panels, Repeaters, and all devices.

### Zone

A situational group of devices. A Zone can consist of a collection of any of the devices connected to the system.

## Introduction

This section covers the physical installation of the system. It primarily focuses on the parts that are required and how they should be connected together. Do not connect the mains power or the batteries at this stage; commissioning the system is covered in the next section of this manual.

Installation should always be performed in accordance with a system plan.

## Main Panel

The control panel should be located where access to the internal components is not restricted and where the unit is not exposed to high levels of moisture, vibration and shock.

Avoid placing the panel in direct sunlight as this may impair programming using the infra-red keypad.

Any metal swarf could damage the PCBs if it is still present when the panel is powered up so it is recommended that all PCBs are removed from the main box whilst the box is being installed. Make a note of the positions of the PCBs before removal.



ELECTRO-STATIC SENSITIVE DEVICES (ESD)  
TAKE SUITABLE ESD PRECAUTION WHEN REMOVING OR  
INSTALLING PRINTED CIRCUIT BOARDS.

**Warning** - observe ESD precautions when handling the PCBs.

## Mains Power Connection

The panel must be earthed.

The LIVE connection must be made to the fused input on the power supply module. This input will also have a BLACK or BROWN wire leading into the power supply unit.

The connector with a BLUE wire leading into the power supply unit is the NEUTRAL.

## Other Main Panel connections

These are detailed in the relevant following sections. Most connections are made from the J-NET-CON.

## Integrated Sub-panels

A Main Panel may have an Integrated Sub-panel. To enable the Integrated Sub-panel a Loopcard must be fitted to the Main Panel PCB. The Loopcard is secured on to 4 pillars behind the LCD module.

You may fit a 1 or 3 loop Loopcard.

If the Loopcard is fitted, an ANALOGUE LOOP CONNECTION BOARD is also required. This is mounted inside the Main Panel box and requires a cable form between it and the Main Panel PCB.

Ensure all connectors are correctly aligned.

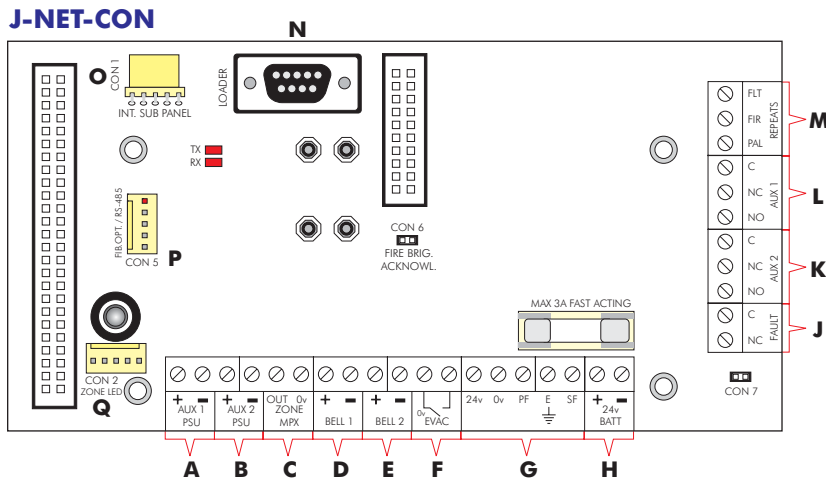

- A** Auxiliary power supply output for powering external devices.
- B** Auxiliary power supply output for powering external devices.  
Both auxiliary power supply outputs are individually power limited and supervised. Max. Current Rating/ Output is 230 mA b@ 27.5 V DC nominal.
- C** Zone multiplex output for zone or mimic panel.
- D** Conventional Sounder Circuit 1.
- E** Conventional Sounder Circuit 2.  
Each Conventional Sounder Circuit is current limited and monitored for both open and short circuit fault conditions. The use in each circuit of a 10 K ohms E.O.L. resistor is required. Max. Current Rating/ Output is 400 mA @ 27.5 V DC nominal.  
**WARNING:** The total current load of all detection loops, sounder circuits and auxiliary supply outputs should not exceed the maximum power rating of the panel. Please refer to technical specification tables.
- F** Remote Evacuation / Class Change Input. (Conventional sounder outputs only)
- G** System Power Input (pre-wired and monitored).
- H** Battery Connection
- I** Earth Point.
- J** Auxiliary Fault Relay Output. (Activated by any fault present on the system)  
This relay output will remain closed while there are no faults present in the system. Under any fault condition present, the relay will be de-energised and the relay contact will be open.
- K** Auxiliary Fire Relay Output 2. → (Activated by any fire situation present
- L** Auxiliary Fire Relay Output 1. → on the system, disabled by front button)  
Under the presence of any Fire Alarm condition, these 2 relays will be energised. Both set of contacts are of the change-over type. Max. Contact current rating for each set of relay contacts is 1 Amp @ 50 V AC/DC resistive.  
**WARNING:** Relay outputs are not supervised. Please ensure that any wiring connected to these outputs is power limited.
- M** Pre-alarm, Fault and Fire, Open Collector Outputs.
- N** Loader Interface: For Upload/Download Software
- O** CON 1: Used to connect to other sub-panels within a self-contained panel
- P** CON 5: Used for connecting RS485 , Fibre-Optic, and TCP/IP
- Q** CON 2: Used for MPX, Zone LEDs

## **Repeaters**

Repeaters are installed in a similar manner to the Main Panel.

Mini Rep repeaters are supplied by an external 24Vdc, normally from the control panel.

The Repeater should be located where access to the internal components is not restricted and where the unit is not exposed to high levels of moisture, vibration and shock.

Avoid placing the Repeater in direct sunlight as this may impair programming using the infra-red keypad.

Any metal swarf could damage the PCBs if it is still present when the Repeater is powered up so it is recommended that all PCBs are removed from the box whilst the box is being installed. Make a note of the positions of the PCBs before removal.

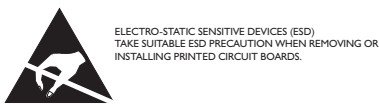

**Warning** - observe ESD precautions when handling the PCBs.

### Mains Power Connection

The Repeater must be earthed.

The LIVE connection must be made to the fused input on the power supply module. This input will also have a BLACK or BROWN wire leading into the power supply unit.

The connector with a BLUE wire leading into the power supply unit is the NEUTRAL.

### Integrated Sub-panels

A Repeater may have an Integrated Sub-panel. To enable the Integrated Sub-panel a Loopcard must be fitted to the Repeater PCB. The Loopcard is secured on to 4 pillars behind the LCD module.

You may fit a 1 or 3 loop Loopcard.

If the Loopcard is fitted an ANALOGUE LOOP CONNECTION BOARD is also required. This is mounted inside the Repeater box and requires a cable form between it and the Repeater PCB.

Ensure all connectors are correctly aligned.



### Standard Sub-panels

Standard Sub-panels need 28.5V DC to operate. This should be supplied from the Power Supply Unit found inside the box.

Standard Sub-panels need a Loopcard fitted to operate. This fits on top of the sub-panel and almost completely covers it. This is usually supplied fitted but if not ensure that all connectors are correctly aligned before fitting the 4 retaining screws.

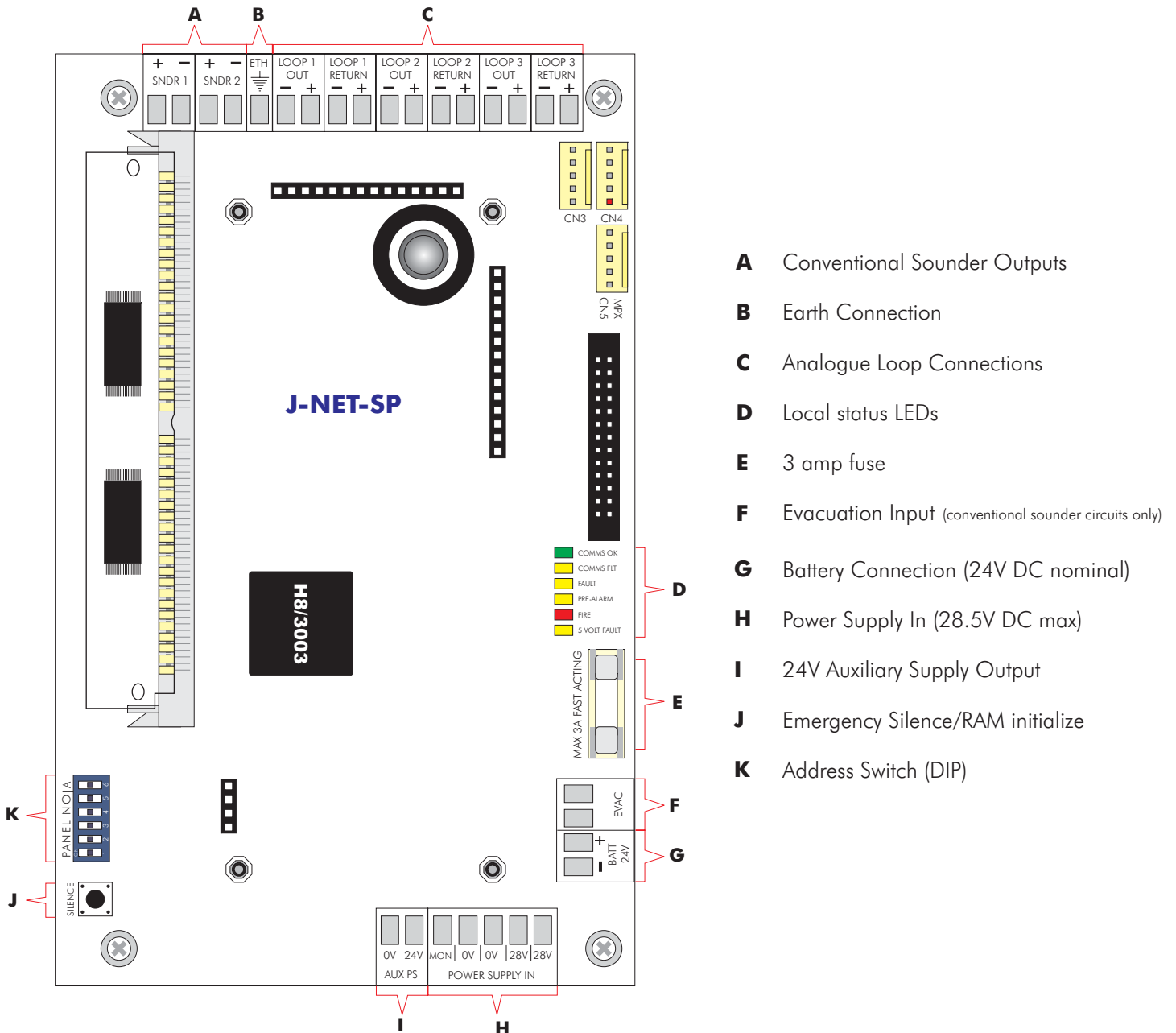

**NOTE:** To monitor an external power supply, a third wire should be connected between the MON and the 0V on the external power supply's 0V connection. If the power supply is installed in the same cabinet as the sub-panel, a link must be fitted between MON and 0V at the power supply IN connection terminals.

**Data Loops**

If the system is distributed, the communication between the main panel and the external sub-panels or repeaters is supported by either an RS422/485 fully redundant loop, fibre-optic cable or alternatively by TCP/IP.

For redundancy in the case of RS422/485 and Fibre Optic this can be wired in the form of a Loop, thus protecting the Data Loop from interruptions or short circuits by creating a bi-directional communications flow. If the panel loses communications with the repeater it will try via the opposite path.

RS422/485 may be used for distances of up to 1200m. For longer distances (up to 4,5km) Fibre Optic Data connections should be used.

**JUNO-NET TOPOLOGIES**

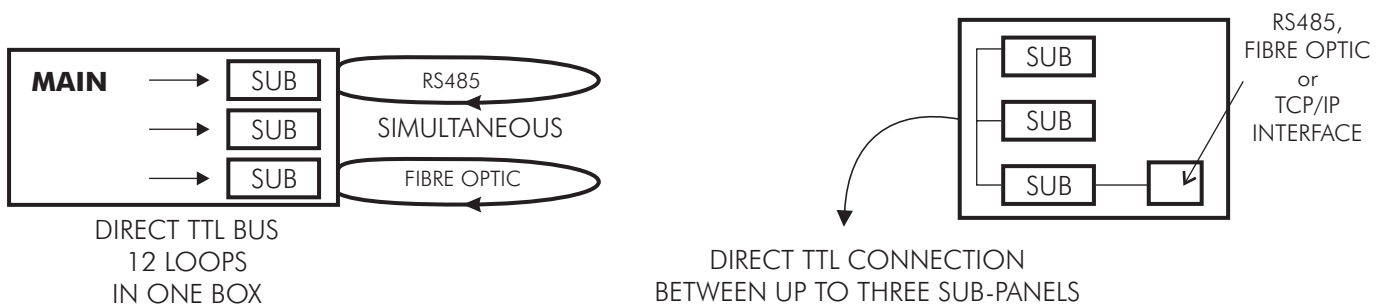
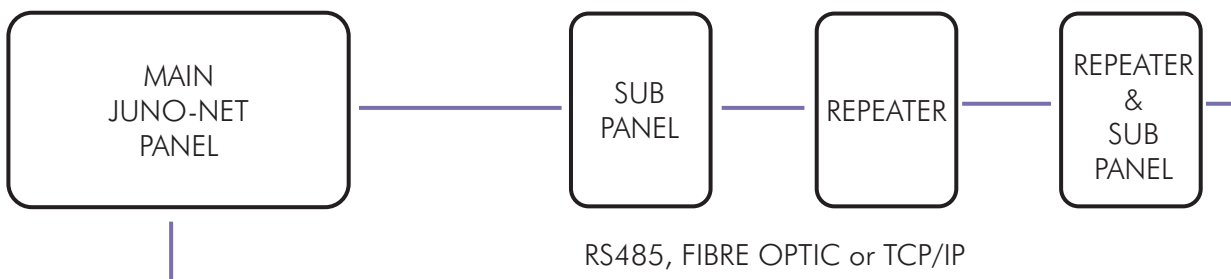

**Main Panel RS485**

**Note - Make all connections with the power turned off to avoid risk of permanent damage to the circuit boards.**

If an external data loop is required, the main panel will need an RS485, a FIBRE OPTIC or a TCP/IP INTERFACE BOARD fitted to the main panel Connector Board.

**J-NET-CON**

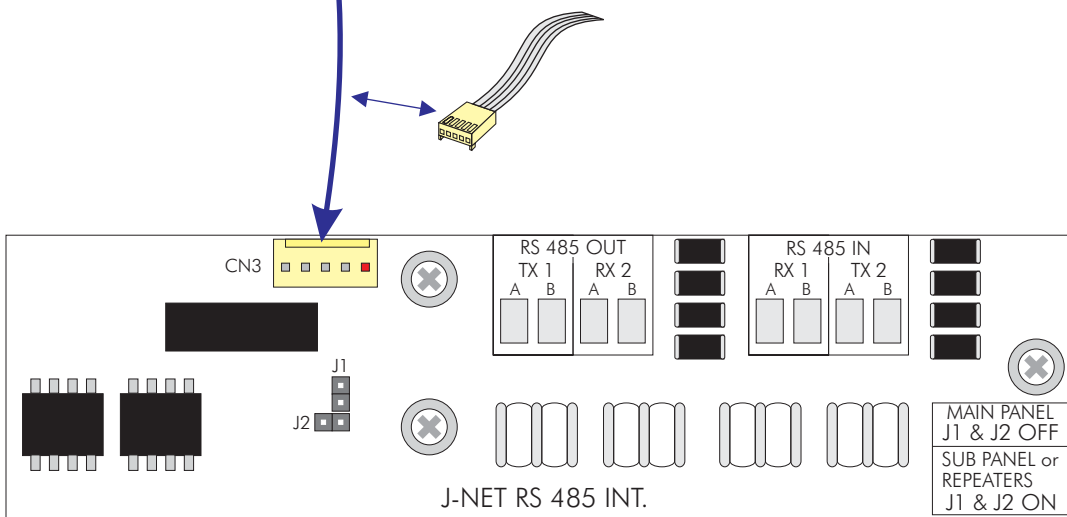
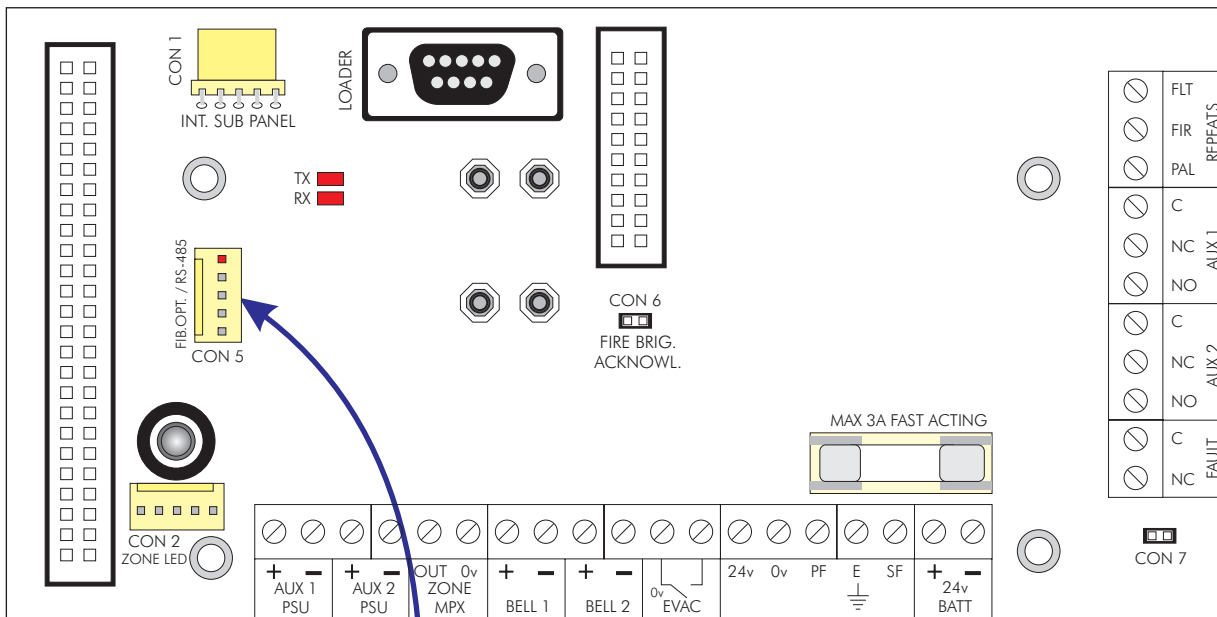

**J-NET-RS485-INT-NEW-NEW**

Data Loop Interface Configuration

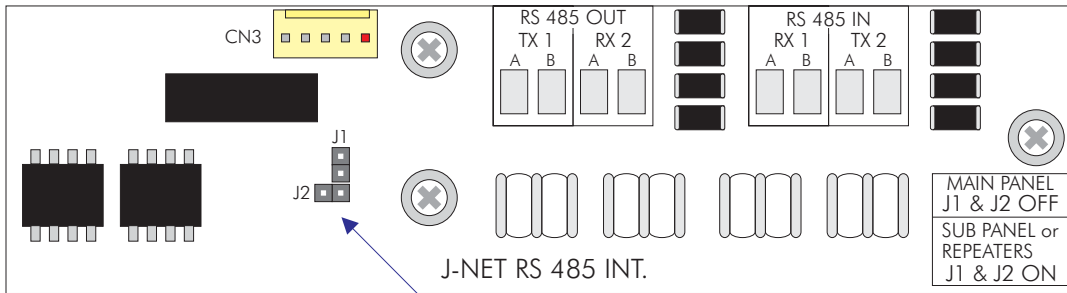

**J-NET-RS485-INT-NEW**

**LINKS**

J1 & J2

MAIN PANEL = **OFF**

REPEATER / SUB-PANEL = **ON**

If these interfaces are to be used at the Main Panel, all links on both the RS485 INTERFACE BOARD (J1 & J2) and FIBRE-OPTIC INTERFACE BOARD (LK1 & LK2) should be removed. When used on Repeaters or Sub-panels they should be kept linked.

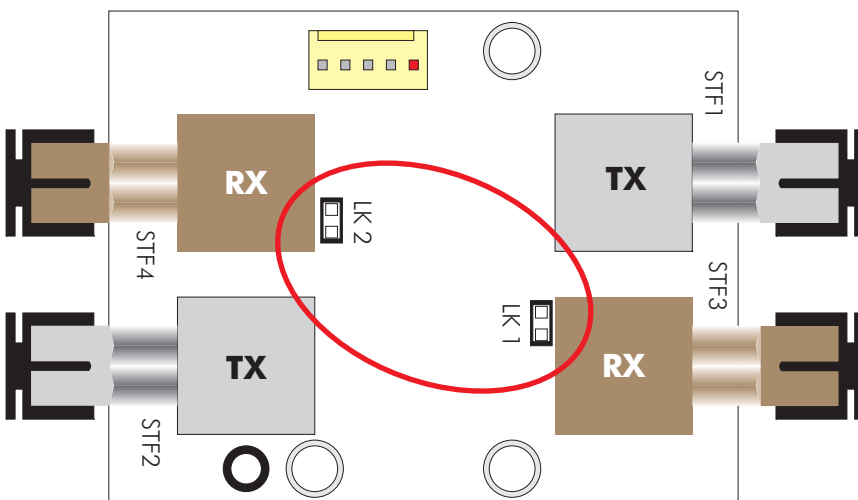

**J-NET-INT-FO**

**LINKS**

MAIN PANEL = **OFF**

REPEATER / SUB-PANEL = **ON**

### Repeater RS485

**Note - Make all connections with the power turned off to avoid risk of permanent damage to the circuit boards.**

The Repeater will need an RS485, a FIBRE OPTIC or a TCP/IP INTERFACE BOARD fitted to its Connector Board.

### J-NET-CON

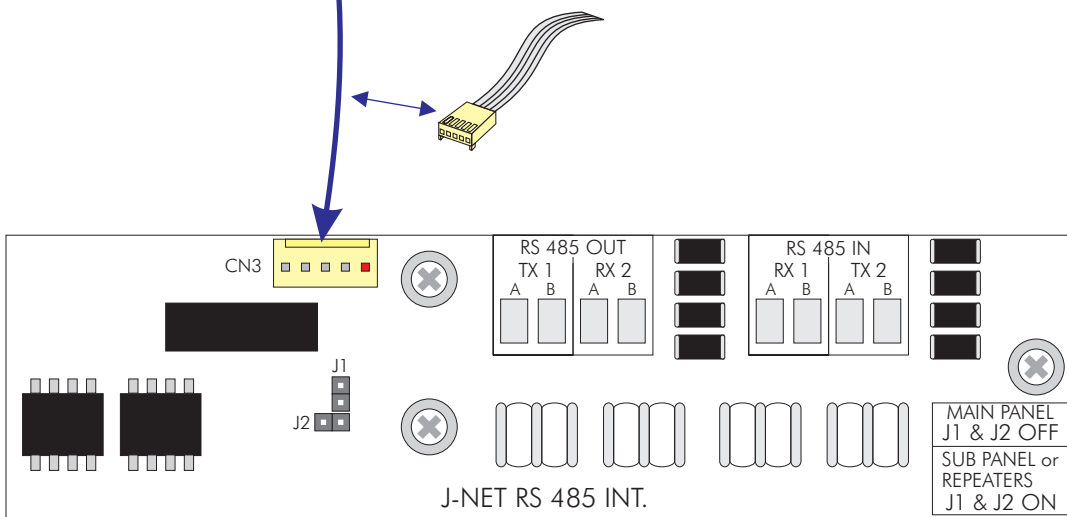
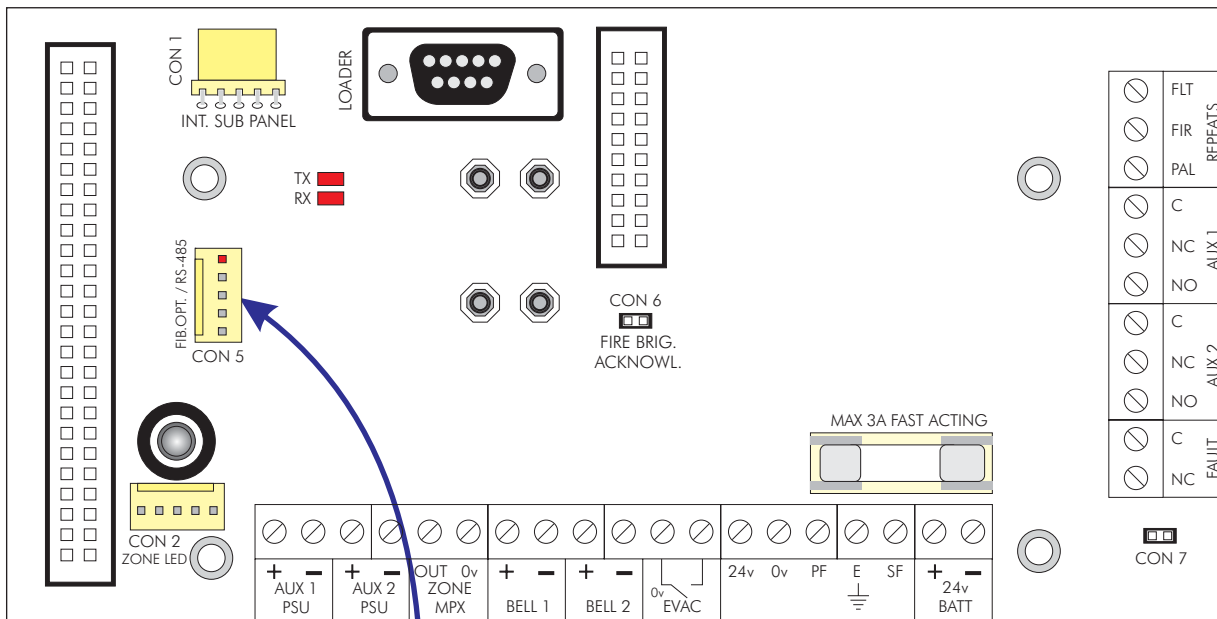

### J-NET-RS485-INT-NEW

### Standard Sub-panel RS485

If more than one Sub-panel is mounted within a single enclosure, only one RS485 INTERFACE BOARD or FIBRE-OPTIC INTERFACE BOARD needs to be used. The Standard Sub-panels will be interconnected via a TTL bus using a cable form in a daisy-chain from CN4 in the first Sub-panel to CN3 in the next and on to CN3 on the RS485 INTERFACE BOARD or CON1 on the FIBRE-OPTIC INTERFACE BOARD.

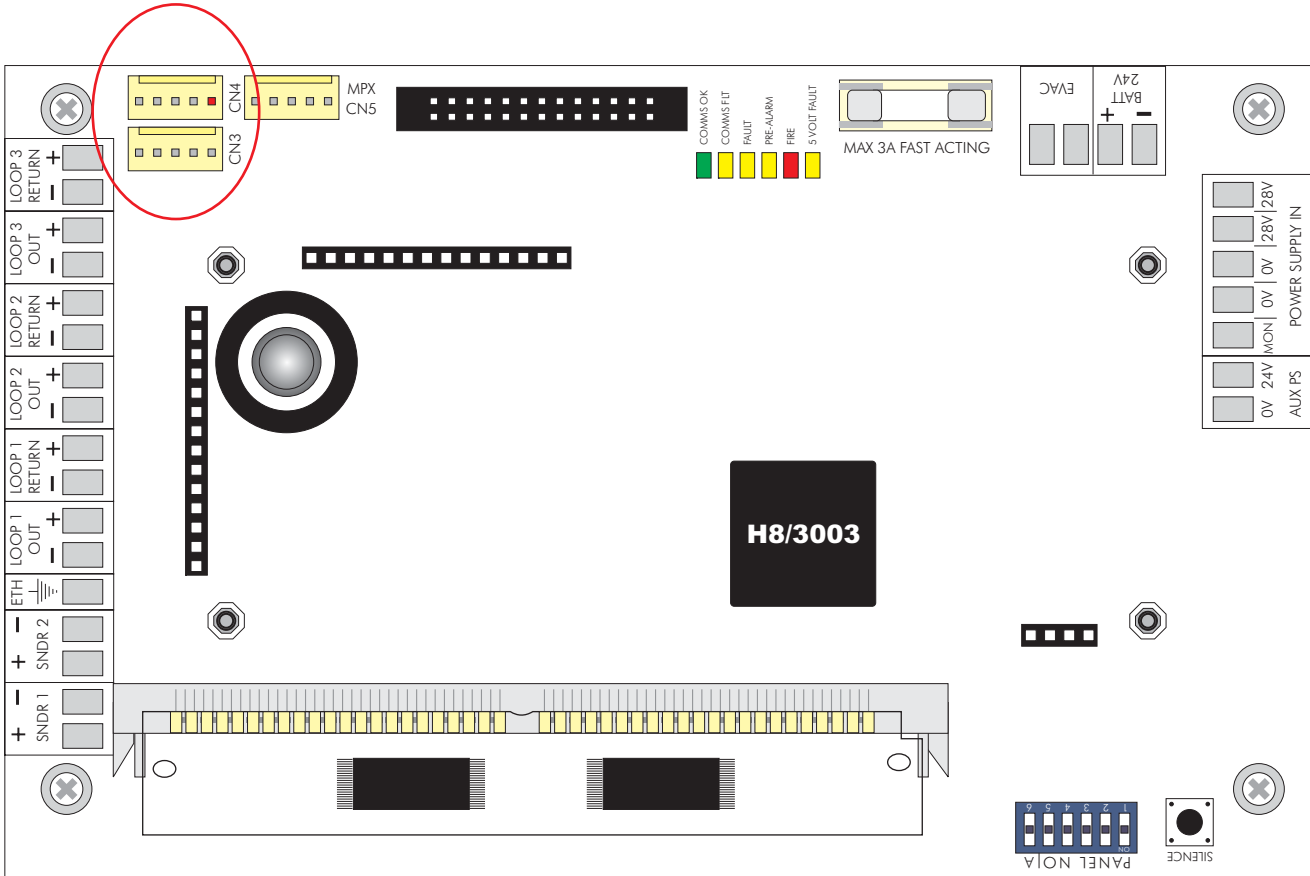

### J-NET-SP

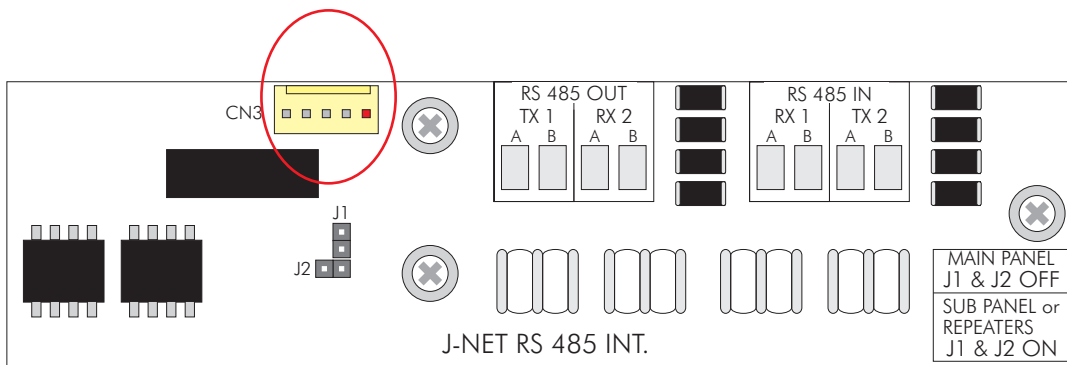

### J-NET-RS485-INT-NEW

### RS485 External Connection

The 4 wire external RS485 connections should be made as below:

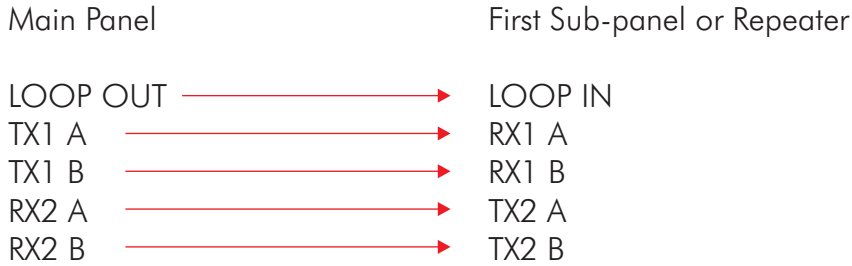

Then continue to connect OUT of one Repeater/Sub-panel to IN of the next Repeater/Sub-Panel following the same connection rules as above.

When you reach the last Repeater/Sub-panel in the loop make the connections as follows:

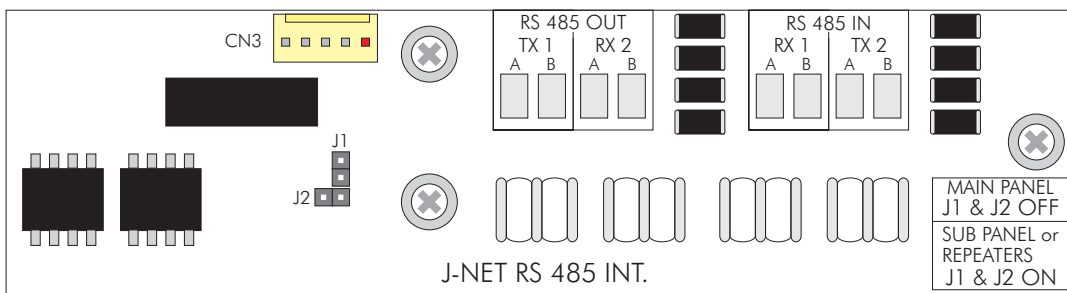
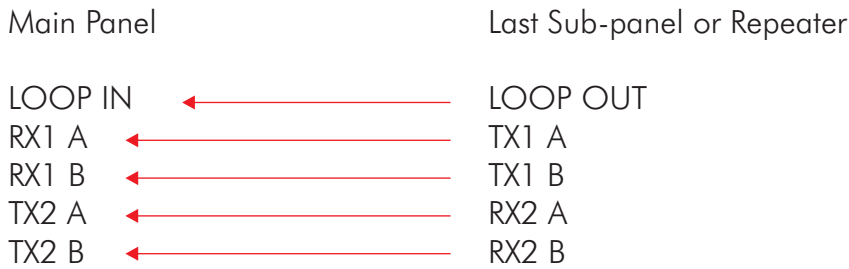

### J-NET-RS485-INT-NEW

### Connection Schematic for Self-Contained Panels

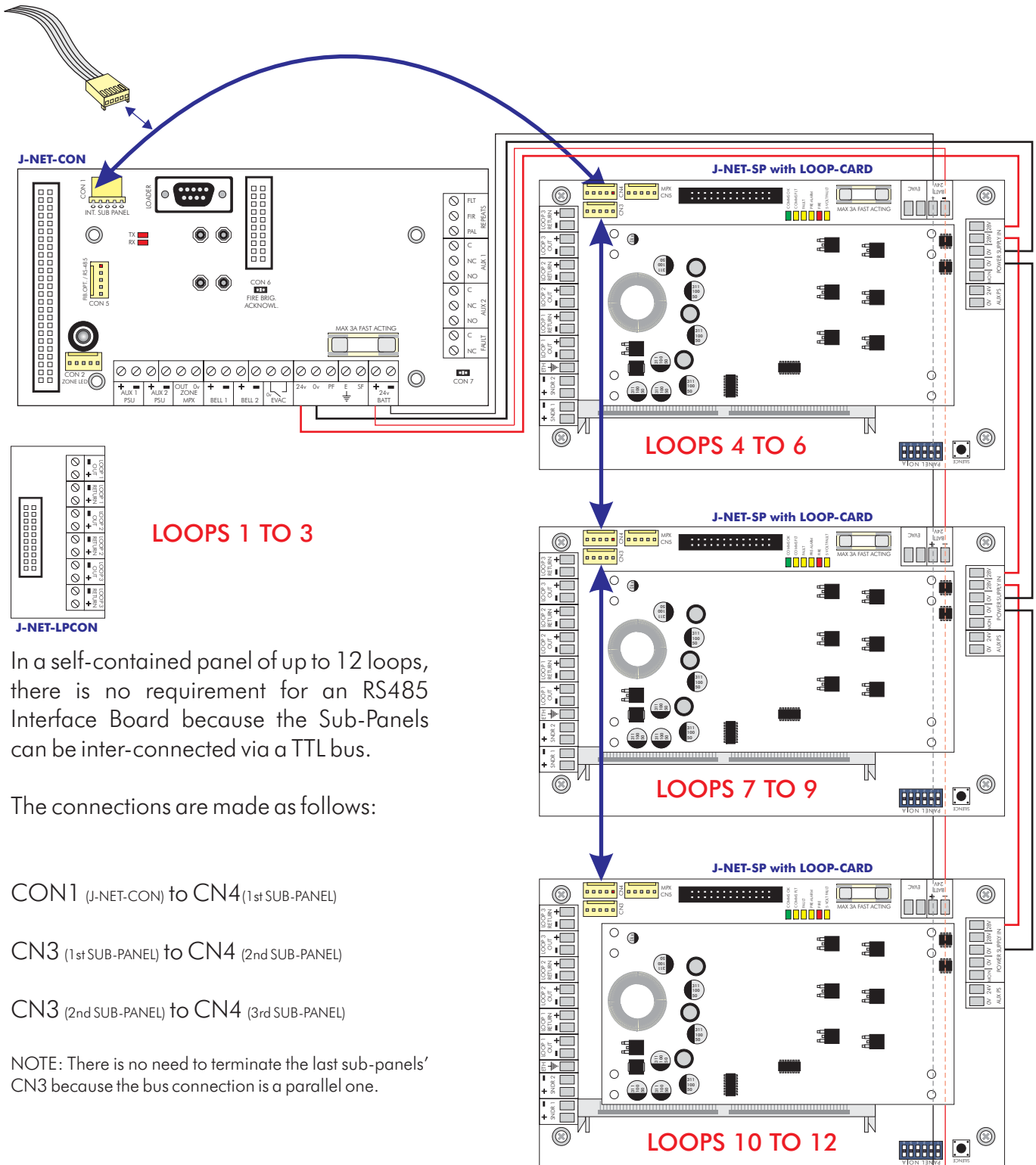

In a self-contained panel of up to 12 loops, there is no requirement for an RS485 Interface Board because the Sub-Panels can be inter-connected via a TTL bus.

The connections are made as follows:

CON1 (J-NET-CON) to CN4 (1st SUB-PANEL)

CN3 (1st SUB-PANEL) to CN4 (2nd SUB-PANEL)

CN3 (2nd SUB-PANEL) to CN4 (3rd SUB-PANEL)

NOTE: There is no need to terminate the last sub-panels' CN3 because the bus connection is a parallel one.



Connection Schematic: Main Panel to External Sub-Panel(s)

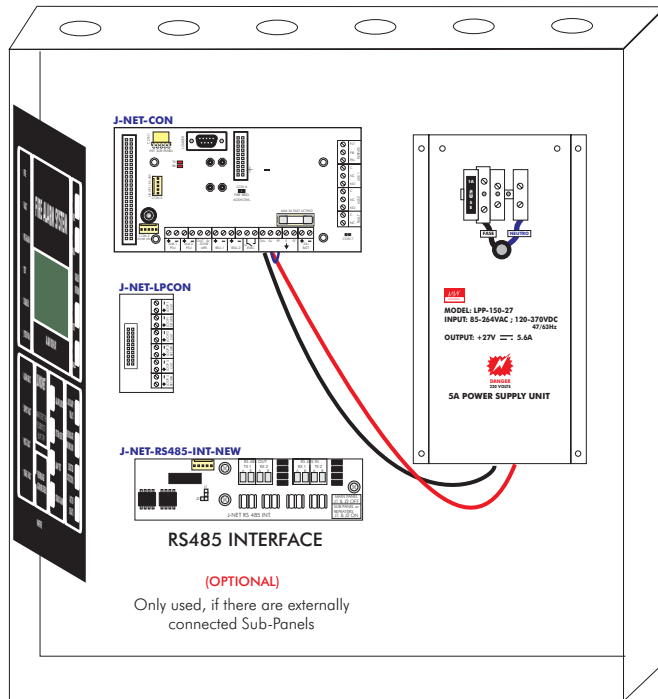

SEE NEXT PAGE

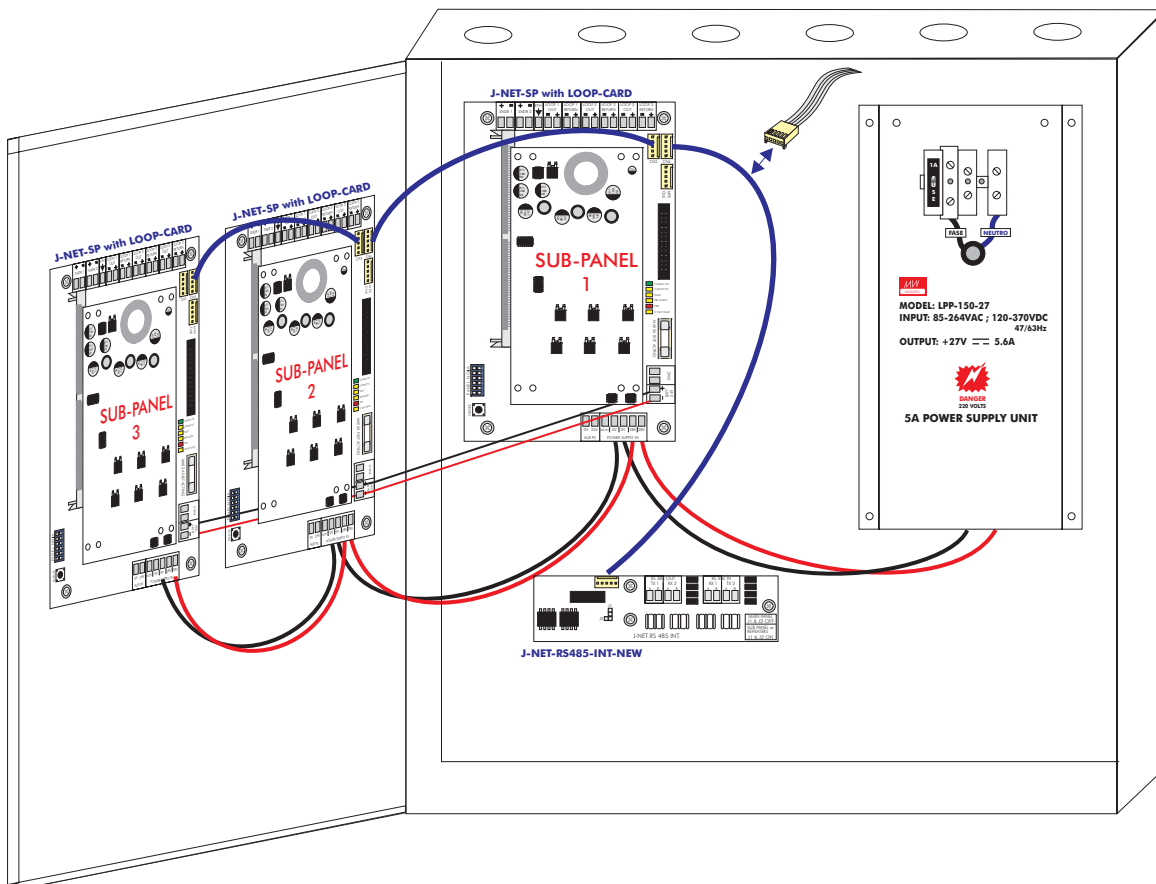

Connection Schematic: Main Panel to External Sub-Panel(s) via RS485

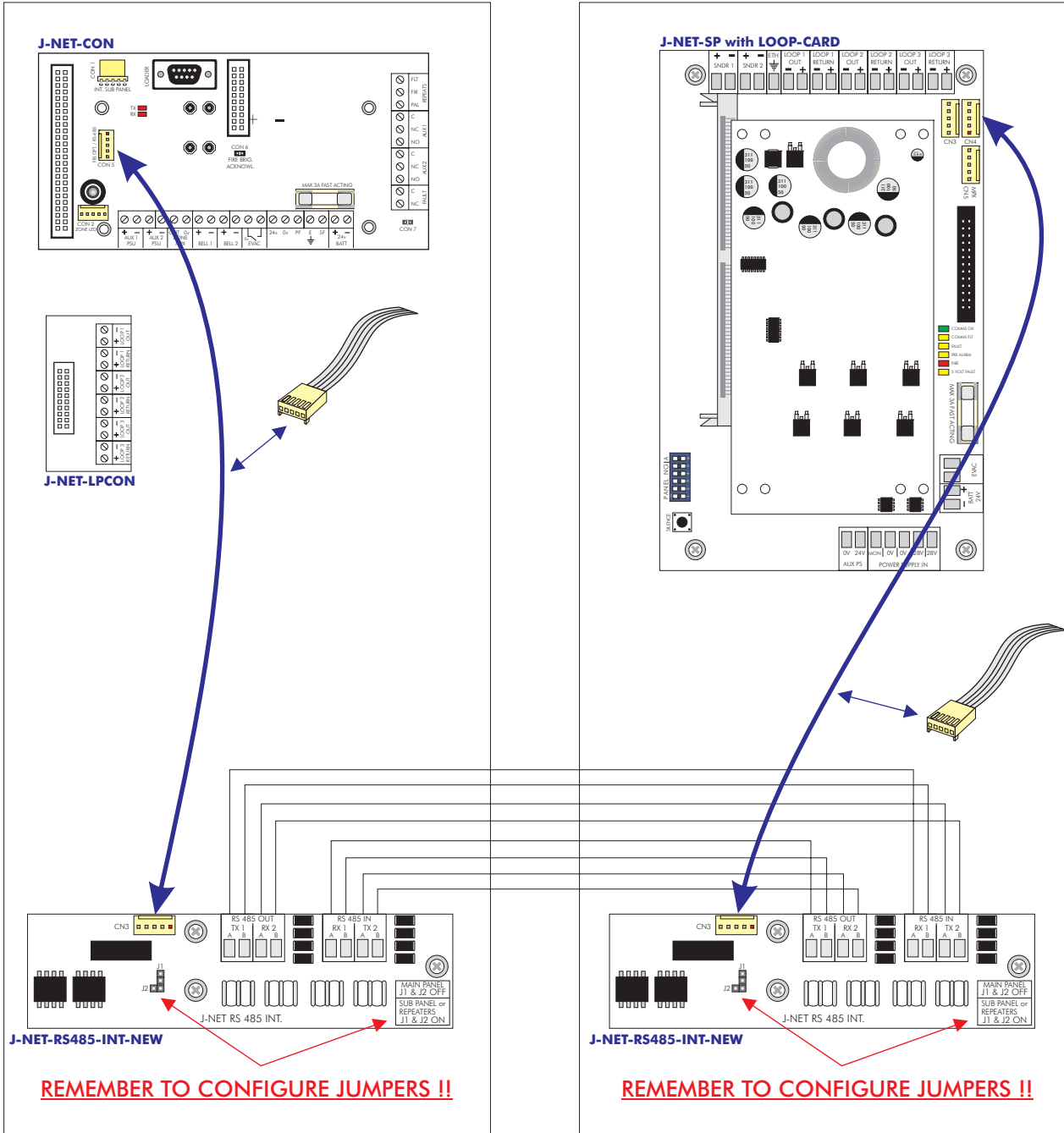

MAIN PANEL

EXTERNAL SUB- PANEL

CON 5 J-NET-CON	CON 3 RS485 INTERFACE
PIN # 1	PIN # 1
PIN # 2	PIN # 2
PIN # 3	PIN # 3
PIN # 4	PIN # 4
PIN # 5	PIN # 5

CON 3 or 4* SUB-PANEL	CON 3 RS485 INTERFACE
PIN # 1	PIN # 1
PIN # 2	PIN # 2
PIN # 3	PIN # 3
PIN # 4	PIN # 4
PIN # 5	PIN # 5

\*CON 3 AND 4 ARE IN PARALLEL  
CONNECTIONS CAN BE MADE TO EITHER ONE

**FIBRE-OPTIC**

**MAINPANEL**



**EXT. SUB-PANEL**

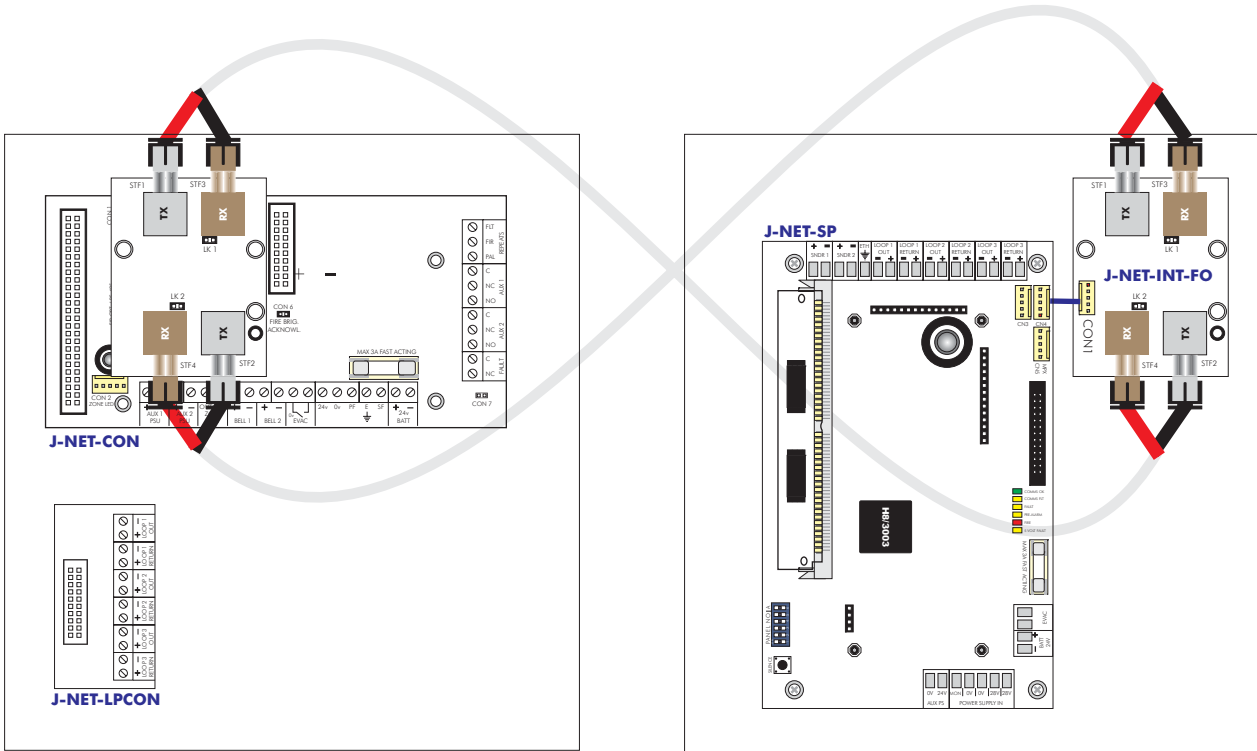

MAIN PANEL

STANDARD SUB- PANEL

**FIBRE-OPTIC**

**MAINPANEL**



**REPEATER**

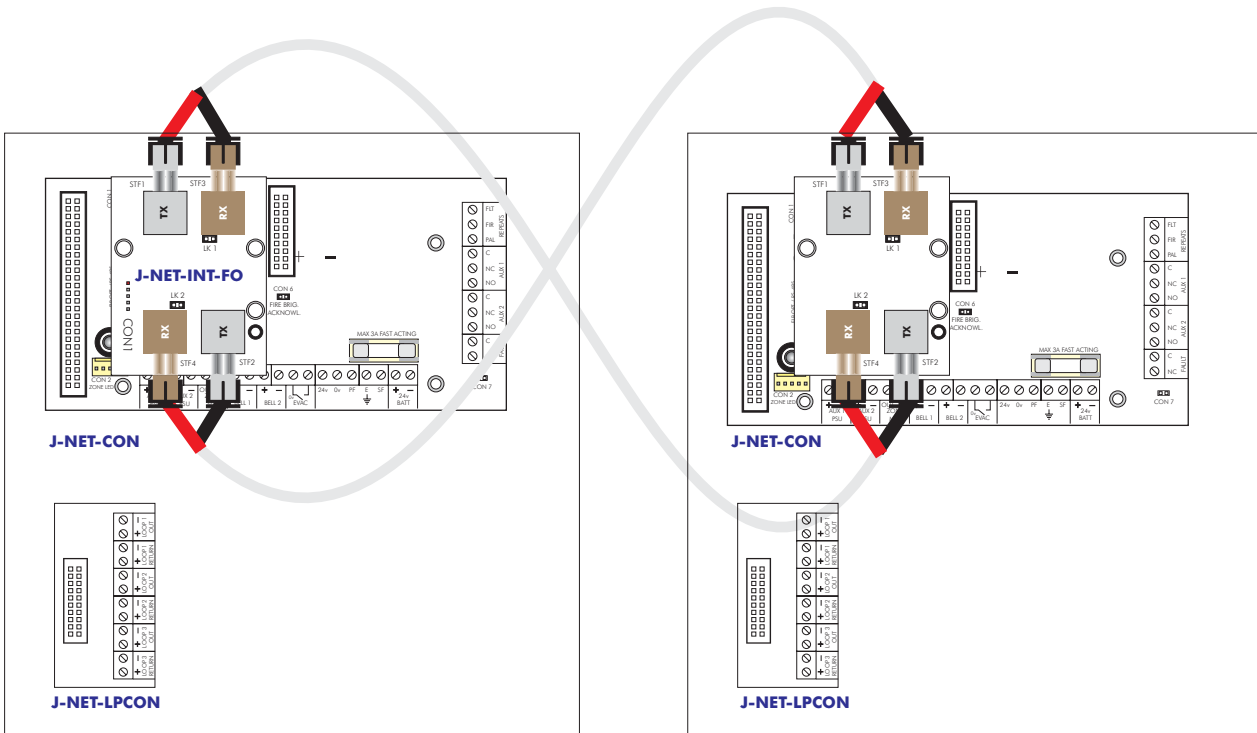

MAIN PANEL

REPEATER PANEL

Connection Schematic: Main Panel to Repeater Panel(s) via RS485

**MAINPANEL** ← RS485 → **REPEATER**

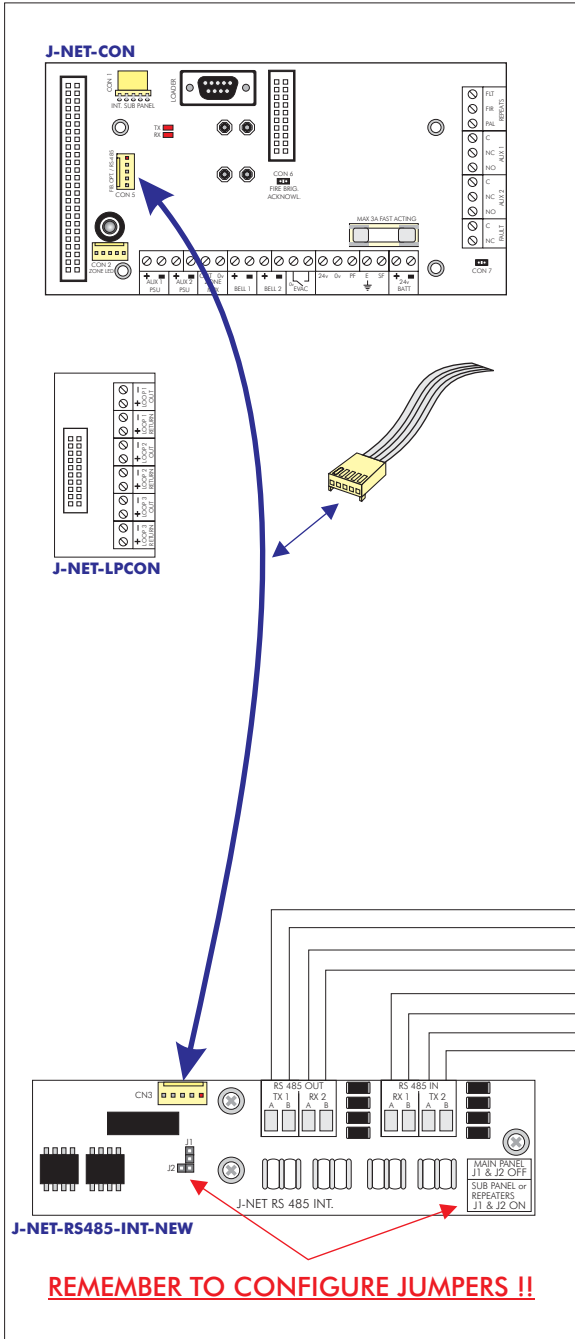

MAIN PANEL

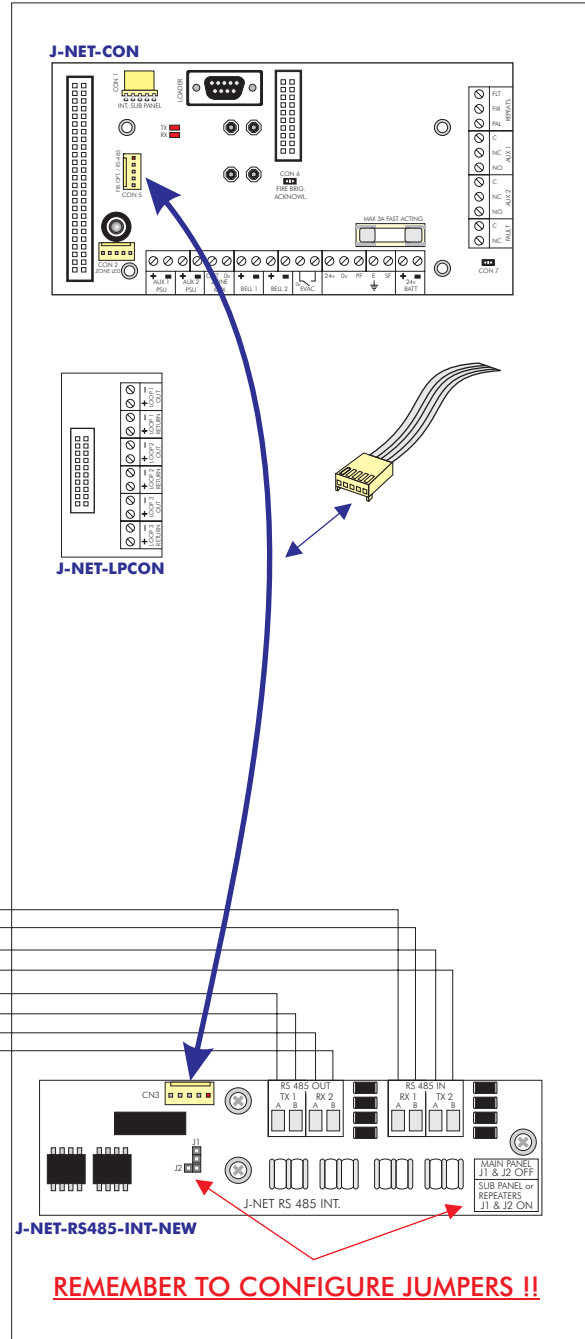

REPEATER PANEL

CON 5 J-NET-CON	CON 3 RS485 INTERFACE
PIN # 1	PIN # 1
PIN # 2	PIN # 2
PIN # 3	PIN # 3
PIN # 4	PIN # 4
PIN # 5	PIN # 5

CON 5 J-NET-CON	CON 3 RS485 INTERFACE
PIN # 1	PIN # 1
PIN # 2	PIN # 2
PIN # 3	PIN # 3
PIN # 4	PIN # 4
PIN # 5	PIN # 5

### Main Panel Fibre Optic

Use a single FIBRE OPTIC INTERFACE BOARD instead of the RS485 INTERFACE BOARD.

STF2 and STF4 on one side of the PCB can be considered the IN connection.  
STF1 and STF3 on the other side of the PCB can be considered the OUT connection.

Connection is made using fibre optic cable instead of copper cable. The ends of the fibre must be terminated with ST™ type Fibre-optic connectors.

**NOTE:**At the Main Panel, LK1 & LK2 should be removed. Failure to do so will inhibit communication between the Main panel and the Sub-panels.

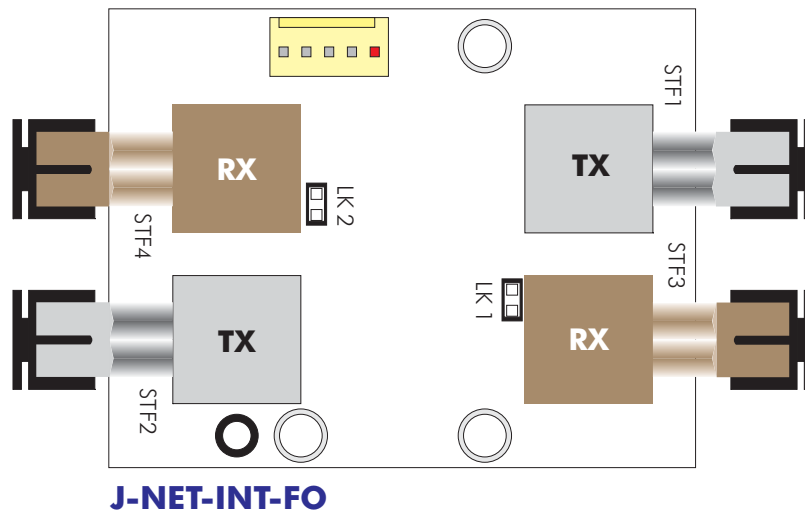

### Repeater Fibre Optic

Use a single FIBRE OPTIC INTERFACE BOARD instead of the RS485 INTERFACE BOARD.

STF2 and STF4 on one side of the PCB can be considered the IN connection.  
STF1 and STF3 on the other side of the PCB can be considered the OUT connection.

Connection is made using fibre optic cable instead of copper cable. The ends of the fibre must be terminated with ST™ type Fibre-optic connectors.

**NOTE:**At the Repeater Board, LK1 & LK2 should be fitted. Failure to do so will inhibit communication between the Main panel and the Sub-panels.

Fibre Optic External Connection

The dual fibre external fibre optic connections should be made as below:

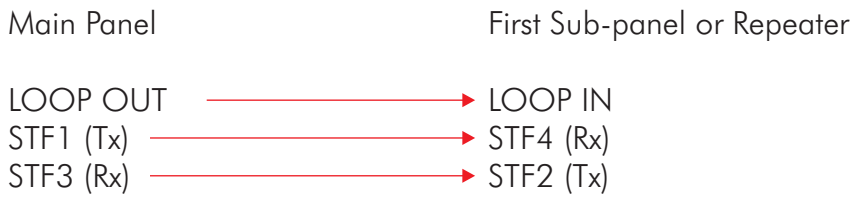

Then continue to connect OUT of one Repeater/Sub-panel to IN of the next Repeater/Sub-Panel following the same connection rules as above.

When you reach the last Repeater/Sub-panel in the loop make the connections as follows:

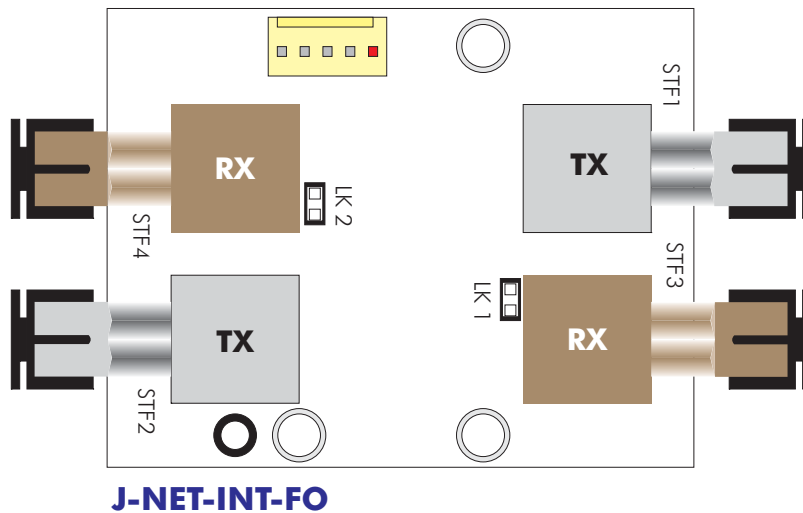
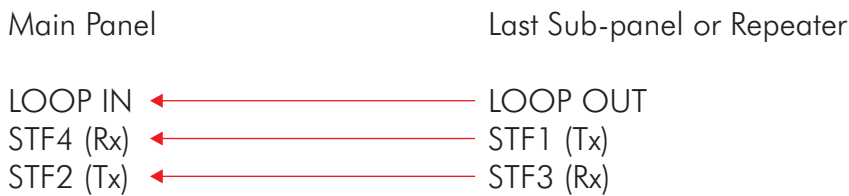



Wire each loop as shown. Unused loops must have links left in position, otherwise the panel will indicate a fault.

**J-NET-LPCON**

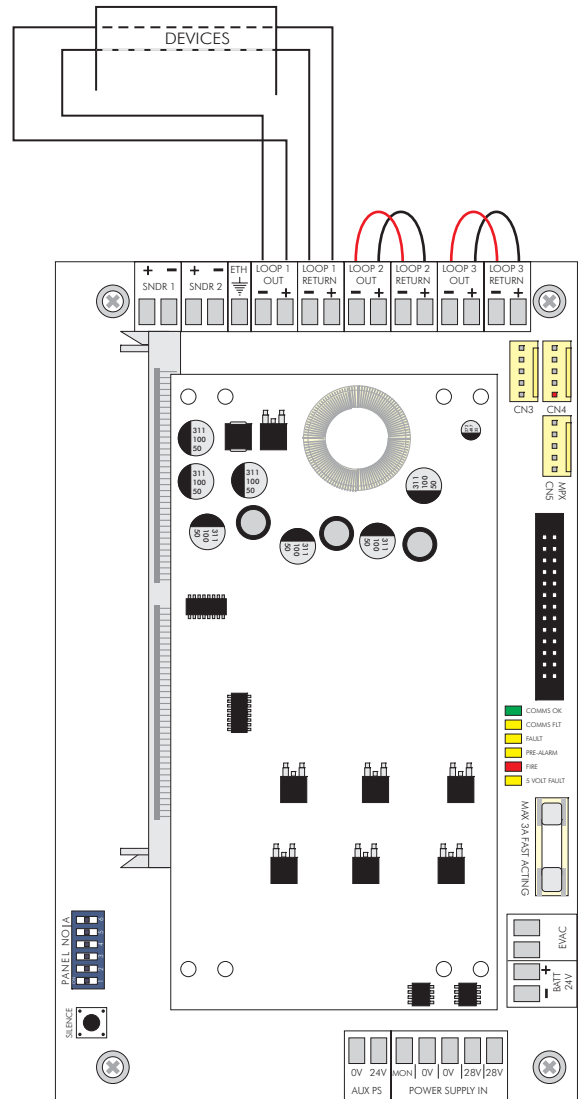
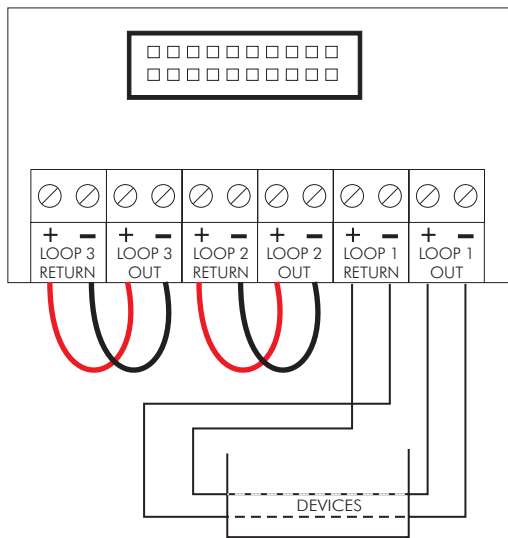

**J-NET-SP with LOOP-CARD**

Make the connections to the devices as specified on the device data sheet. If no data sheet is available make the connections as below:

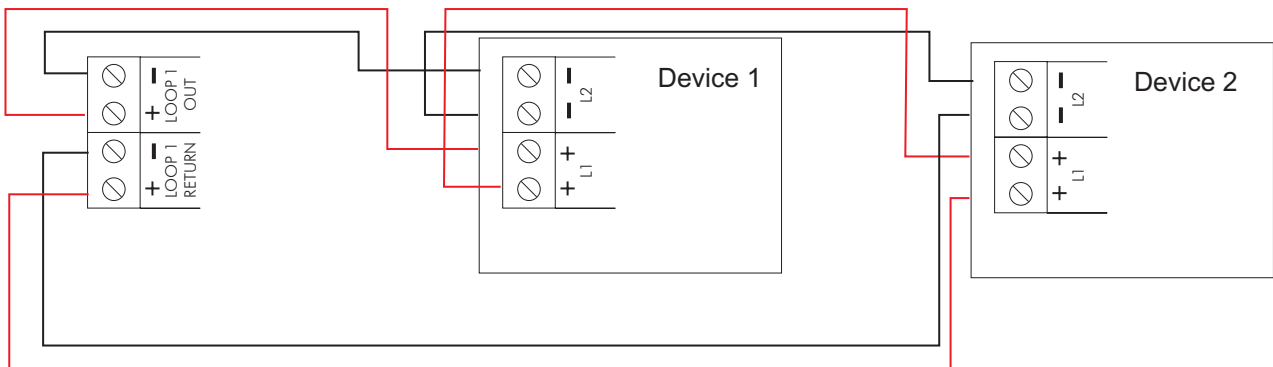

**Note** - a maximum of 32 manual call-points can be fitted to any one loop. If this value is exceeded the response time for certain types of call-point will be excessive.



## Conventional Sounders

Conventional Sounders is the term used to describe conventional alarm sounders (or bells) connected directly to a Main Panel, Repeater or Sub-panel.

Loop-powered Sounders are different and are connected to the Analogue Loop.

Two Conventional Sounder circuits are provided on the Main Panel and on Repeaters with Integrated Sub-panels. More than one Conventional Sounder may be connected to each circuit. Alarm current limited to 400mA per output.

All Conventional Sounder circuits are monitored for open and short circuit faults. If a Conventional Sounder output is not used, then a 10K resistor must be connected across its output terminals.

### J-NET-SP with LOOP-CARD

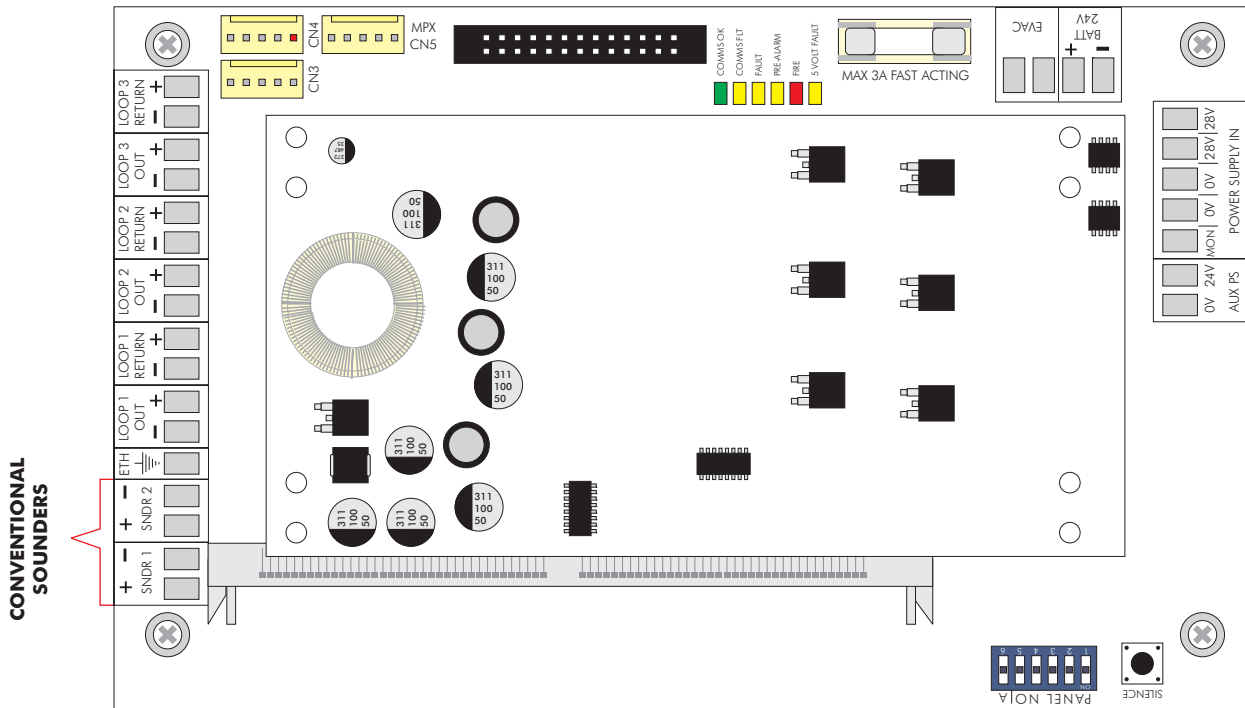

### J-NET-CON

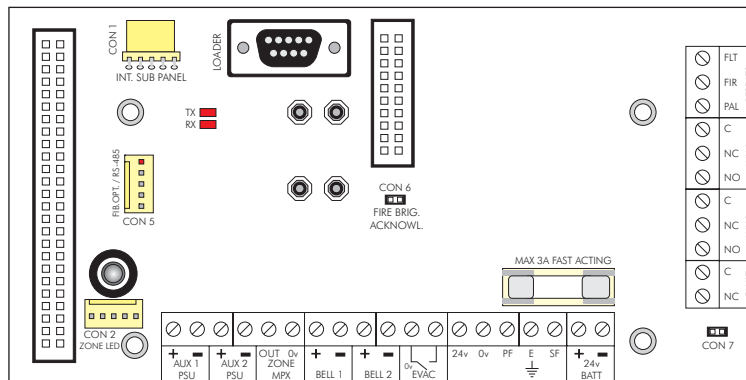

### CONVENTIONAL SOUNDERS

## Auxiliary Fire Relays (2) and Fault Relay (1)

Two auxiliary fire relay outputs are provided on the J-NET-CON. These outputs are activated when a fire is detected (unless specifically inhibited). They are labeled AUX1 and AUX2.

One auxiliary fault relay output is also provided on the J-NET-CON. This output is activated when a fault is detected.

Both Auxiliary Fire relays have Normally Open (NO) and Normally Closed (NC) contacts and a single Common (C) connection. The Auxiliary Fault relay is energised (NC) while there are no faults present on the system and de-energised (NO) when there is at least one fault on the system.

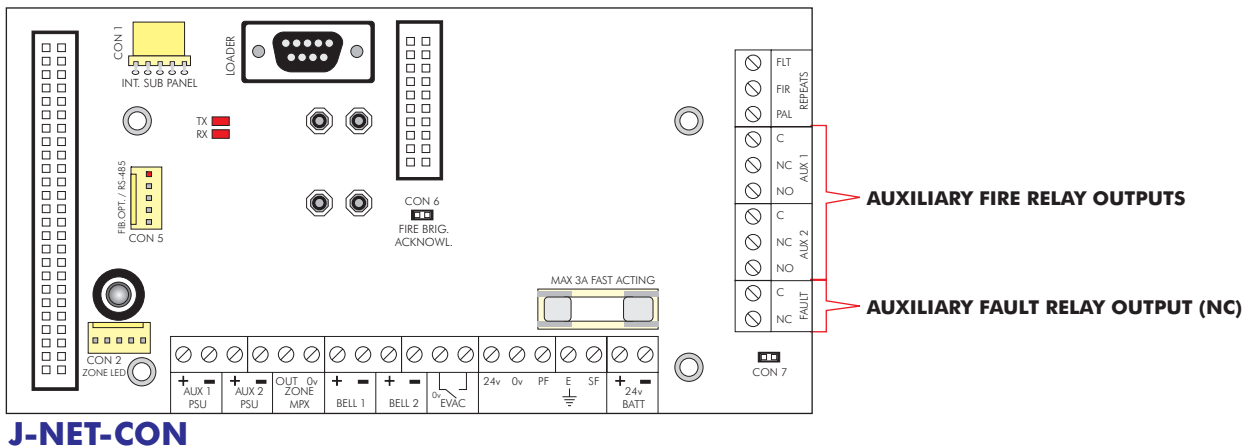

## Open Collector Repeat Outputs

The J-NET-CON provides open-collector repeater outputs for activating Fire, Fault and Pre-alarm indicators.

These 3 outputs are rated at 100mA 24V DC max.

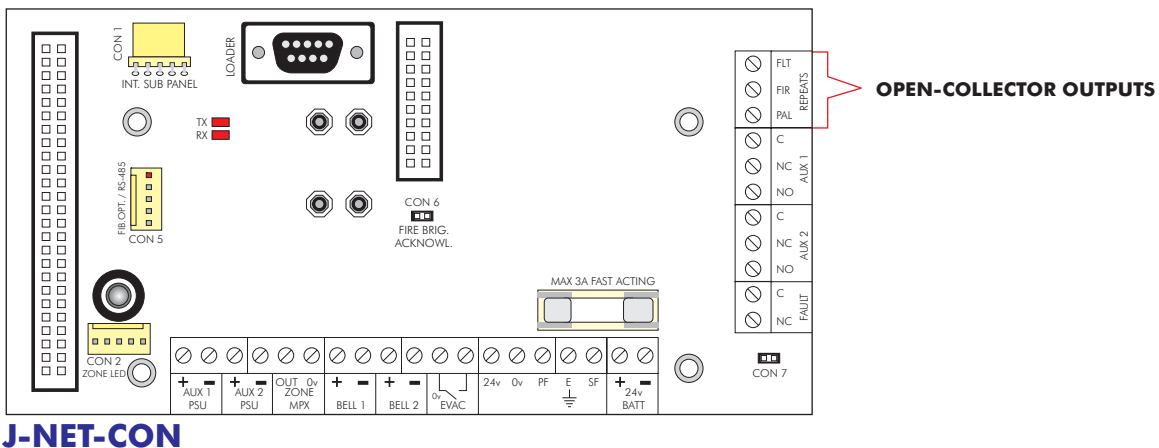

## **Fire Brigade Transmission**

Connection is via the extension socket on the J-NET-CON. Only the Main Panel has a Fire Brigade Transmission output even though a connector is present in Repeaters.

**This board (not shown) will have its own data sheet.**

### **Printer (optional)**

The printer (optional) is supplied fitted to the main panel. It is only necessary to remove the elastic band and label from the printer paper. If you do not do this the printer could be damaged if it is operated.

If required the printer can be disabled via the Main Panel programming functions.

The printer requires a Quart fitted on the Main Panel PCB (ESD precautions necessary).

There can only exist one printer per system, fitted on the Main Panel.

## Main Panel Batteries

It is recommended that the batteries are fitted at the end of commissioning the system otherwise it can be difficult to remove the power quickly if there is a problem.

The batteries are connected to the CONNECTION BOARD in the Main Panel. This battery connection not only supplies the panel with power if the primary supply should fail, it also provides a charging output to maintain the batteries in a fully charged state.

Before connecting the batteries check the voltage across the resistor connected to the battery connection terminals. It should be 28.5V +/- 0.2V. Remove the resistor before connecting the battery.

**Note - arcing and fire risk. Never short circuit the battery terminals. Always connect the blue wire between the batteries last.**

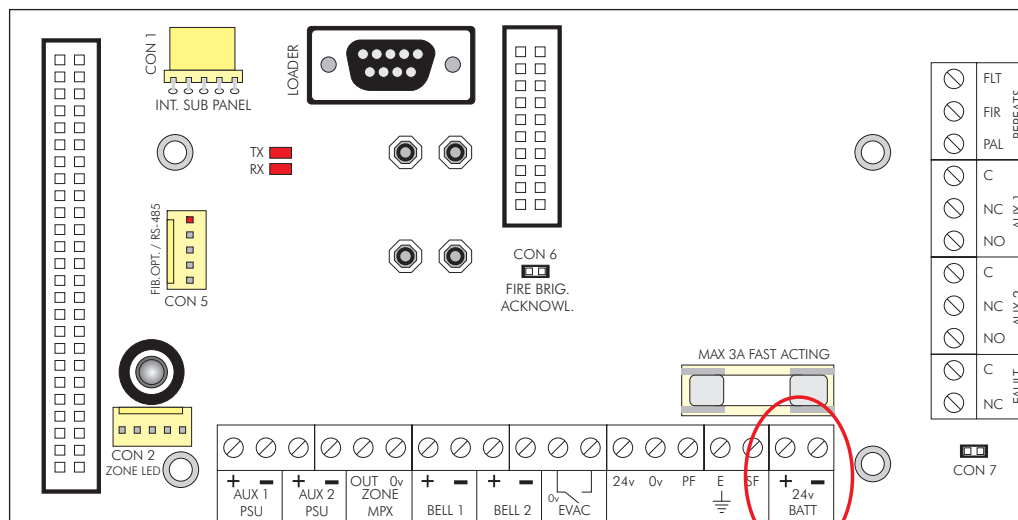

**J-NET-CON**

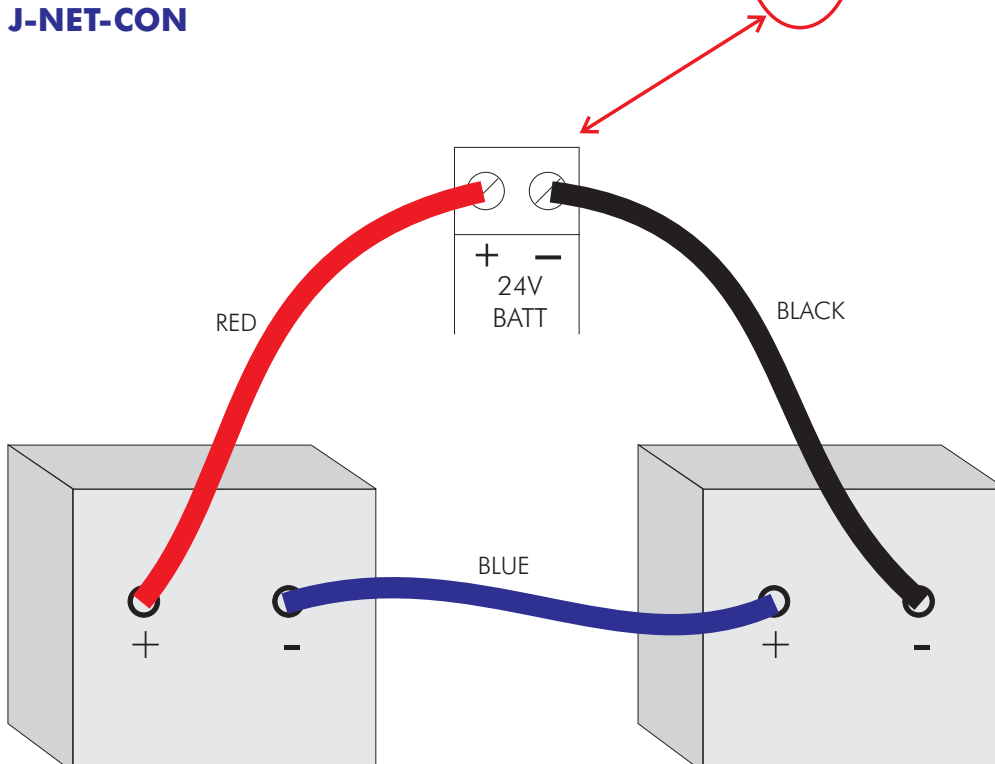

## Sub-panel Batteries

Make sure that those sub-panels that DO NOT have batteries connected DO have the resistor fitted across the battery connection terminals. The resistor prevents the panel reporting a battery fault.

**Note - arcing and fire risk. Never short circuit the battery terminals. Always connect the blue wire between the batteries last.**

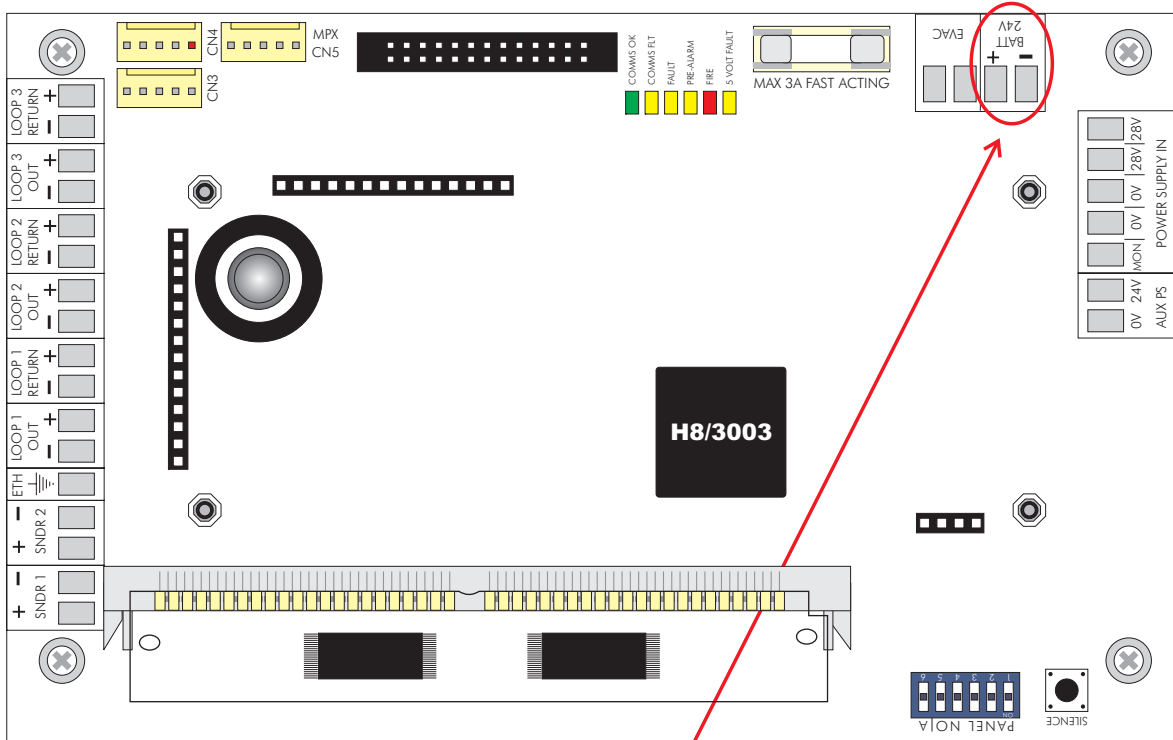

**J-NET-SP**

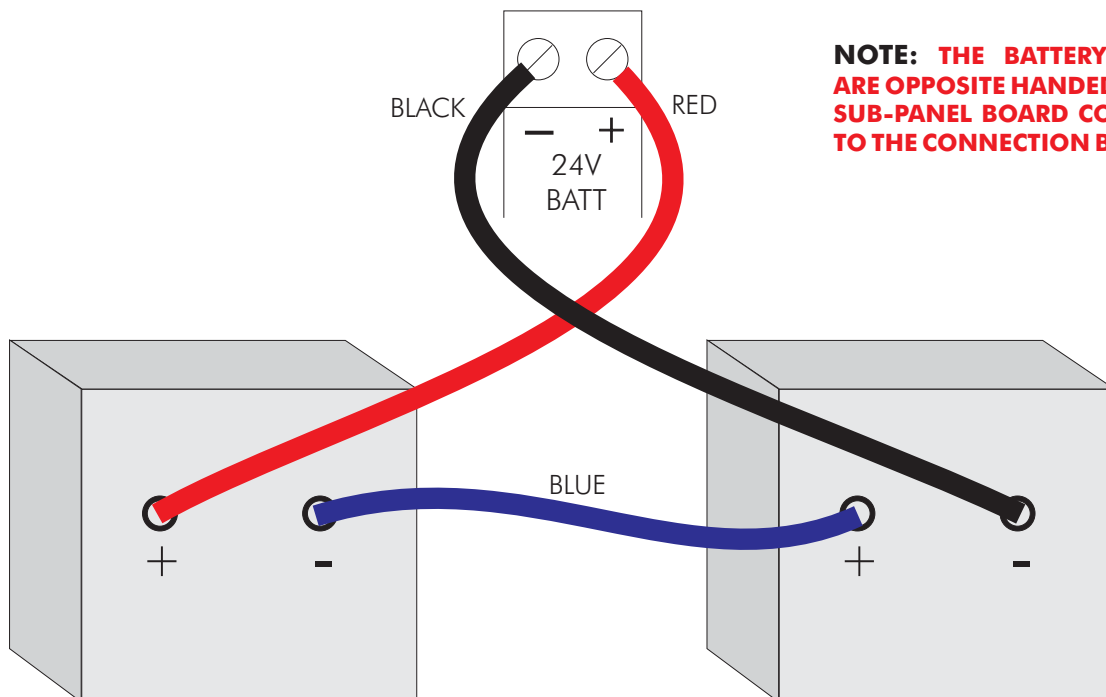

**NOTE: THE BATTERY CABLES ARE OPPOSITE HANDED ON THE SUB-PANEL BOARD COMPARED TO THE CONNECTION BOARD.**

### **ODYSSEY - Windows™ based PC Graphics Software Output**

A PC running this Graphics Management Software can be connected to the panel via either an RS232, RS485, Fibre-Optic or TCP/IP data link. This can be achieved by connecting the relevant J-NET-ADV-COMS Interface board onto the 20 way box header present on the Connector Board (See picture below). The communication data rate is 9600 baud with 8 data bits, 1 stop bit and no parity. Connection to a PC requires a suitable interface for the chosen communications media. Alternatively the same Advance Comms Interface may be used for connection to a standard modem. Using the modem allows remote monitoring and control via the telephone network. Connection to a modem requires an RS232 extension.

### **BMS**

A Building Management System (BMS) can be connected to the Main Panel via an RS232 link. This can be achieved by plugging a Comms Adapter interface board onto the 20 way box header present on the Connector Board. The communication data rate is 9600 baud with 8 data bits, 1 stop bit and no parity.

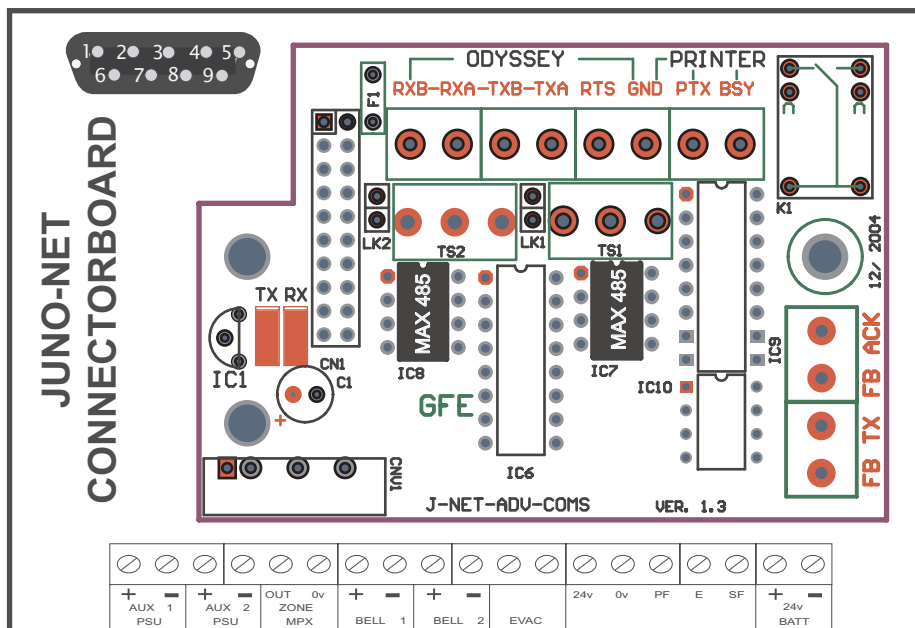

## Introduction

Commissioning involves checking that all connections have been made properly and that all hardware is functioning correctly. This means the system must first be installed in accordance with the previous section of this manual.

The panel is supplied set to 'Installation mode'. In Installation Mode the green SYSTEM ON LED will flash on and off. The panel will automatically detect and memorize all the devices connected to the loops in the system.

The default settings of the system mean that the unit will be ready to operate and detect a Fire incident from the moment power is switched on. Therefore, the system will be fully functional without any additional setting up. All further actions will tailor it to the requirements of the specific installation at hand.

Once the connections and hardware have been checked it is possible to get the basic fire alarm system up and running very quickly - it is only necessary to have the system in Installation Mode for 90 seconds then set the system to 'Active Mode'. Programming of the system to provide more advanced functionality is covered in the next section.

Unless otherwise indicated, in order to enable the operation of a particular switch, either a valid User or Programming Access Code is required to be entered.

The only exceptions are the following:

- 1- Lamp Test Switch
- 2- Queue Review Switches( Fire, fault, Test and Disabled)
- 3- Delays Active Switch. During an alarm condition and while delays are active.

By entering a valid User Access Code (Factory default ▲▲▲▲▲), the authorized user gains access to the operation of all switches at the front of the panel's display. Authorized User Access also grants the possibility of enabling or disabling zones.

## The Main Panel Buttons

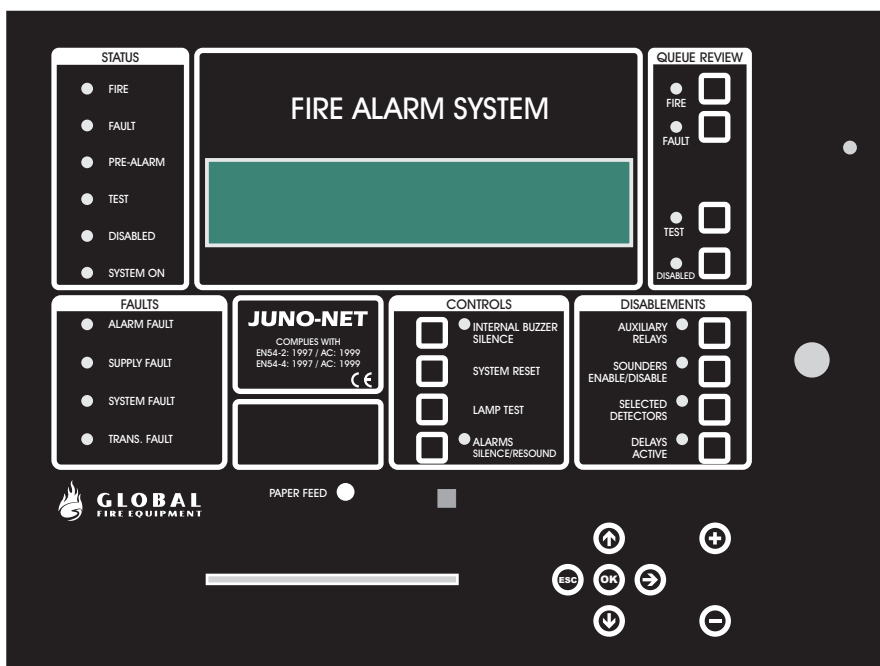



## INTERNAL BUZZER SILENCE

The occurrence of any new fire or fault condition will initiate the operation of the internal buzzer. By pressing this switch, the operation of the buzzer will be stopped until a new fire or fault appears on the system.

## SYSTEM RESET

Soft resets the entire system. A soft reset should be satisfactory under almost all circumstances however a Master Reset can be performed using the PCB mounted switch on the main PCB (not shown) or by cycling the power on the Main Panel (removing both primary AC and secondary DC supplies).

**Note** - if an alarm has been detected it is necessary to silence the alarms using SOUNDER SILENCE before the SYSTEM RESET button will operate.

## LAMP TEST - General User Access (no code entry required)

Lights all the LEDs, turns on the LCD back light and sets all display pixels to black. Lamp test only operates whilst the key is depressed.

## ALARMS SILENCE/RESOUND

Activates all sounders. A second press de-activates all sounders. The button LED (RED) is illuminated whilst the sounders are activated. It is possible to define if pressing this button will activate the systems Fire I/O units. Delayed sounder circuits. Pressing this button while the sounder delay is taking place, will also stop. This operation will not stop the evacuation timer.

## AUXILIARY RELAYS (DISABLEMENTS)

When this button is activated all relays and I/O modules connected to the system have their outputs disabled. This includes the normally energised FAULT relay, the FAULT I/O group and all ALARM I/O groups. When these outputs are disabled the button LED is illuminated. Pressing the button again restores normal relay and I/O module operation.

**NOTE: IF I/O'S ARE TO BE ACTIVATED BY EVAC. CONDITION, THIS WILL OVERRIDE THE DISABLEMENT**

## SOUNDERS ENABLE/DISABLE

Pressing this button will enable/ disable all sounders both conventional sounder circuits and addressable sounders.

## SELECTED DETECTORS (DISABLEMENTS)

Via the programming menus individual sensors may have selective disablement turned on. When this button is activated those sensors that have selective disablement turned on will not generate a fire alarm condition. When activated the button LED is illuminated.

If no devices have selective disablement turned on then this button press will have no effect. Pressing the button again restores normal sensor operation.

## DELAYS ACTIVE

Pressing this button will activate any pre-programmed delays. The yellow LED associated with this button and the general disablements led will both be lit. A second press of this button will de-activate the delays and the led.

Under any fire condition the delays will be activated. If during the course of these delays this button is pressed the delays will be overridden and the sounders and together with any other fire indicating equipment, will be activated.

## FIRE (QUEUE REVIEW) - General User Access (no code entry required)

If more than one fire has been detected then the LED next to this button will flash. Press the button to step through all detected fires. Once all fires have been reviewed the LED will be constantly illuminated. Subsequent fires will be added to the end of the queue and the LED will start to flash again.

After each button press the information will be displayed for 20 seconds. After that time the screen will revert back to the first fire.

## FAULT (QUEUE REVIEW) - General User Access (no code entry required)

If more than one fault has been detected, or if a fault and fire have been detected, then the LED next to this button will flash. Press the button to step through all reported faults. Once all faults have been reviewed the LED will be constantly illuminated. Subsequent faults will be added to the end of the queue and the LED will start to flash again.

After each button press the information will be displayed for 20 seconds. After that the screen will revert back to the first fault (or fire).

## TEST (QUEUE REVIEW) - General User Access (no code entry required)

If the LED next to this button is illuminated then a test mode has been selected via the programming menus. Pressing the button will show which sounders and zones have been set to test mode. If there are more zones under test than can be displayed then pressing the button again will show the next set of zones under test.

The information is displayed for 15 seconds before the default display is restored.

**Note** - a SYSTEM RESET will clear all test modes.

## DISABLED (QUEUE REVIEW) - General User Access (no code entry required)

If the LED next to this button is illuminated then there is at least one disablement active in the system. Pressing the button will display the disablements. If there are more disablements that can be displayed then pressing the button again will show the next set of disablements and so on.

The information is displayed for 15 seconds before the default display is restored.

Possible disablements include - printer, fire brigade transmission, auxiliary relays, loops, zones, detectors and sounders.

## PAPER FEED

Each press feeds a single line of paper through the printer.

USER & INSTALLER ACCESS CODES

To enter both codes use the arrow keys **→↑↓** and when finished press Enter/**OK**.

User Access Code, press Enter/**OK**, then **↑↑↑↑↑** and then press Enter/**OK** key to confirm entry.

Installer Access Code, press Enter/**OK**, then **↑↓↑↓↑** and then press Enter/**OK** to confirm entry.

**OK** Used to confirm entry of any data or selection. Same function as the ENTER key on IR remote control.

**↑** Used to increase selection or number. Equivalent function as UP arrow key on IR remote control.

**↓** Used to decrease selection or number. Equivalent function as UP arrow key on IR remote control.

**ESC** Escape key. Used to exit a particular function. Equivalent function as ESC arrow key on IR remote control.

**+** Used to increase loop number. Equivalent function as + arrow key on IR remote control.

**-** Used to decrease loop number. Equivalent function as - arrow key on IR remote control.

**Note:** It is not possible to introduce text for labels using the front panel keypad.

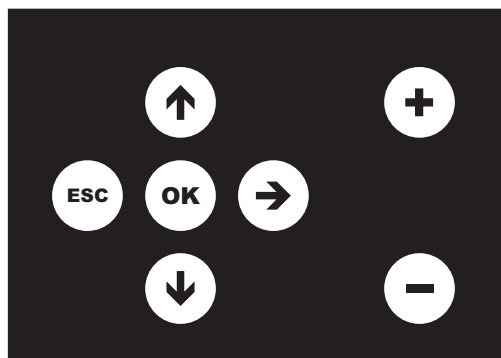

## **Getting The Main Panel Running**

If you have the optional printer fitted make sure that the printer paper is not being held firm by an elastic band or piece of string.

Note that if external sub-panels are not powered up and if the battery has not been connected the Main Panel WILL report faults when it is powered up. This is entirely normal. When this happens silence the buzzer by pressing ALARM SILENCE.

Apply AC power to the Main Panel.

The LCD should display the software version and the message 'INITIALIZING'. This will be followed by the date and time (and the company name if it has been set). Within a few seconds faults will be reported, these will overwrite the date and time (and company name).

The SYSTEM ON LED on the fascia of the panel should be flashing green. This indicates that the system is in Installation Mode. If the LED is solid green the system is in Active Mode and needs to be put into Installation Mode - refer to the programming section for details on how to do this.

If the SYSTEM ON LED is flashing and information is being displayed on the LCD then the Main Panel is functional.

If the PROC FAULT LED is lit and a continuous tone is audible then remove power and confirm that the SIM CARD is fitted correctly.

## **Getting A Repeater Running**

The supply to the repeater can be obtained directly from the auxiliary power supply output on the main panel. Alternatively, a repeater with integrated sub-panel will have a separate, self-contained power supply.

Apply power to the repeater.

If the main panel is powered up and the data loop connections between main panel and repeater(s) were properly made, the information shown on the LCD display as well as the LED indicator status from the main panel will replicate itself on the repeater.

Press the SYSTEM RESET switch and you should see on the LCD display the message "JUNO NET" as well as the software version number, followed by the word, "INITIALIZING".

If after a few seconds upon completion of the initialization phase the LCD display shows the message, "NO COMMS TO MAIN PANEL" and the FAULT Led is lit-up, verify the condition of the main panel. If it is powered up and working properly then verify the data loop connections.

If the PROC FAULT LED is lit and a continuous tone is audible then remove power and confirm that the SIM CARD is fitted correctly.

## **Getting A Standard Sub-panel Running**

If the Standard Sub-panel is fitted within the Main Panel or Repeater box and wired up correctly then the green COMMS OK LED should be either illuminated solidly or flashing when power is applied to the Main Panel or Repeater.

If the Standard Sub-Panel is not housed within Repeater or Main Panel box then it will be necessary to apply power to the Sub-panel.

If the COMMS OK is solid green then it is communicating correctly (via RS485 or TTL) with the Main Panel. If it is flashing then there is no communication with the Main Panel.

The amber FAULT LED will also light if there is no communication with the Main Panel.

If the COMMS OK is permanently lit, then the Sub-panel is functional.

## **Setting Panel Addresses And Types**

Each Repeater and Sub-panel needs a unique address.  
Each Repeater and Sub-panel also needs the detector type set.

### Main Panel Integrated Sub-panel

This has a fixed address of 01.

### Repeater Integrated Sub-panel

The default address for the Integrated Sub-panel on a Repeater is 02.

To set up the Integrated Sub-panel on a Repeater firmly depress the TEST (QUEUE REVIEW) and DISABLED (QUEUE REVIEW) buttons on the Repeater while powering up.

This will power the Repeater up in REPEATER INSTALL MODE. If it does not, try again, the buttons must be firmly held down during the power up process.

Once in REPEATER INSTALL MODE the following options are available:

Press SOUND ALARMS to clear the NVRAM  
Press FIRE (QUEUE REVIEW) to increment the panel number  
Press FAULT (QUEUE REVIEW) to decrement the panel number  
Press TEST (QUEUE REVIEW) to step through the available detector types  
Press SYSTEM RESET to save and exit REPEATER INSTALL MODE

If the system has not been commissioned or installed then it is recommended to clear the NVRAM. Note that this will also set the panel number back to 02.

If the system has been installed then clearing the Repeater NVRAM will clear all the installation information and the SYSTEM **must** be put into INSTALLATION MODE to re-learn the fitted devices. A Main Panel Master Reset **must** also be performed so that all system settings are re-sent to all Repeaters and Sub-panels.

If the panel number is changed the SYSTEM **must** also be put into INSTALLATION MODE to learn the new panel number.

**Standard Sub-panels**

The Standard Sub-panel addresses and detector types are set using the DIP switches on the Sub-panel.

Each Sub-panel has an 6 way DIP switch. The first 5 switches set the panel number.

Note that addresses 01 and 02 are likely to be used by Integrated Sub-panels.

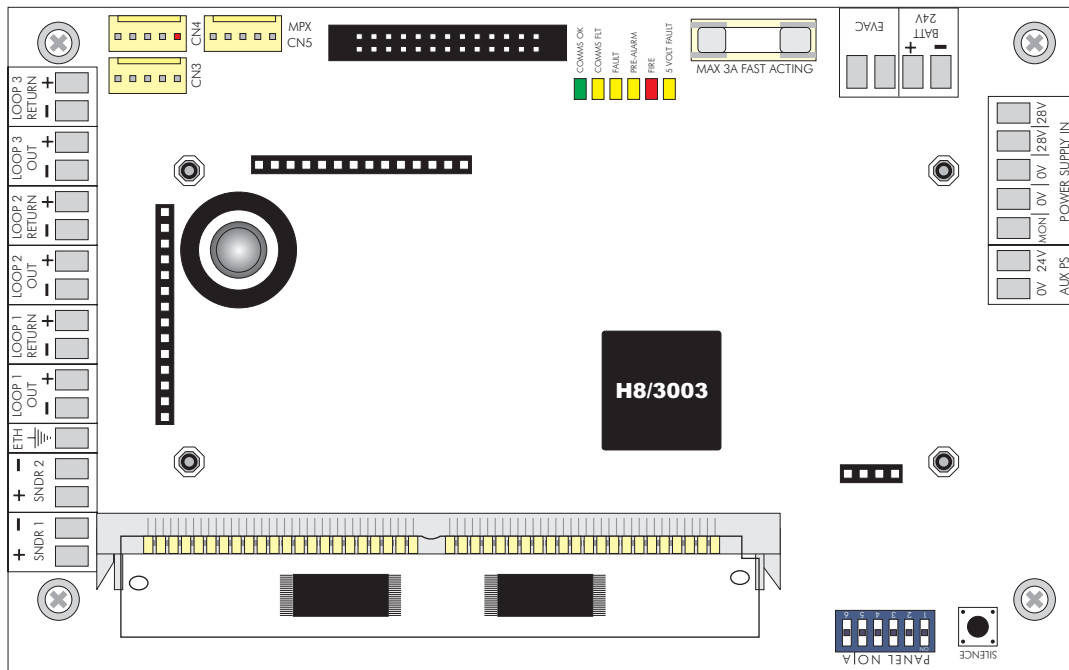

**J-NET-SP**

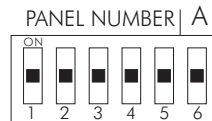

Switch "A" is reserved for future usage

**SUB-PANEL NUMBER SWITCHES 1- 5**

LOOP N°s	ADDRESS	SWITCH 1	SWITCH 2	SWITCH 3	SWITCH 4	SWITCH 5	LOOP N°s	ADDRESS	SWITCH 1	SWITCH 2	SWITCH 3	SWITCH 4	SWITCH 5
1-3	01	0	0	0	0	0	49-51	17	0	0	0	0	1
4-6	02	1	0	0	0	0	52-54	18	1	0	0	0	1
7-9	03	0	1	0	0	0	55-57	19	0	1	0	0	1
10-12	04	1	1	0	0	0	58-60	20	1	1	0	0	1
13-15	05	0	0	1	0	0	61-63	21	0	0	1	0	1
16-18	06	1	0	1	0	0	64-66	22	1	0	1	0	1
19-21	07	0	1	1	0	0	67-69	23	0	1	1	0	1
22-24	08	1	1	1	0	0	70-72	24	1	1	1	0	1
25-27	09	0	0	0	1	0	73-75	25	0	0	0	1	1
28-30	10	1	0	0	1	0	76-78	26	1	0	0	1	1
31-33	11	0	1	0	1	0	79-81	27	0	1	0	1	1
34-36	12	1	1	0	1	0	82-84	28	1	1	0	1	1
37-39	13	0	0	1	1	0	85-87	29	0	0	1	1	1
40-42	14	1	0	1	1	0	88-90	30	1	0	1	1	1
43-45	15	0	1	1	1	0	91-93	31	0	1	1	1	1
46-48	16	1	1	1	1	0	94-96	32	1	1	1	1	1

## Getting Into Programming Mode

When the Main Panel is powered up it will be necessary to enter the panel programming mode. Familiarize yourself with this section before proceeding to the next section in the manual and powering up the panel.

Programming mode is accessed via the panel's keypad (see p.50), the miniature infra-red remote control (IR Keypad) or by connecting a PC (PS2) keyboard to the Main Panel. It is also possible to upload and download settings to a PC but to do this you must first enter the panel programming mode. The main panel's keypad (7 switches) will permit the user to perform all operations for both control and programming but, not for entering text.

### INFRA-RED KEYPAD

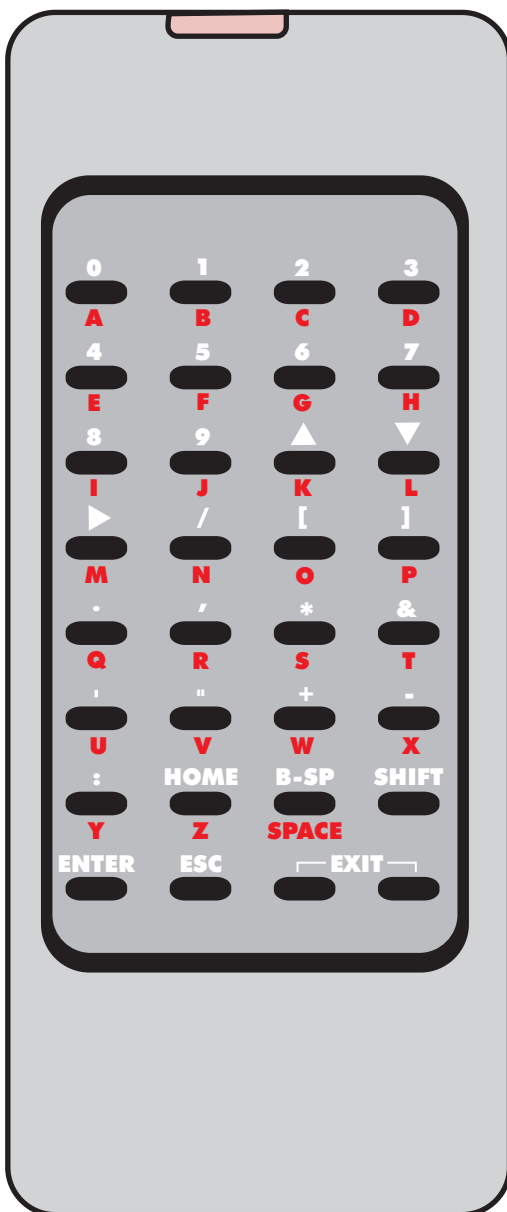

**HOME:** Return to first loop, zone, device etc.

**B-SP:** Backspace

**SHIFT:** Toggle this keypad to switch from alpha-numeric to numeric

**ENTER:** Accept current selection

**ESC.:** Reject. (ESCape from current selection)

**EXIT:** Press both keys simultaneously to stop programming



## Connecting A PS2 PC Keyboard To The Main Panel

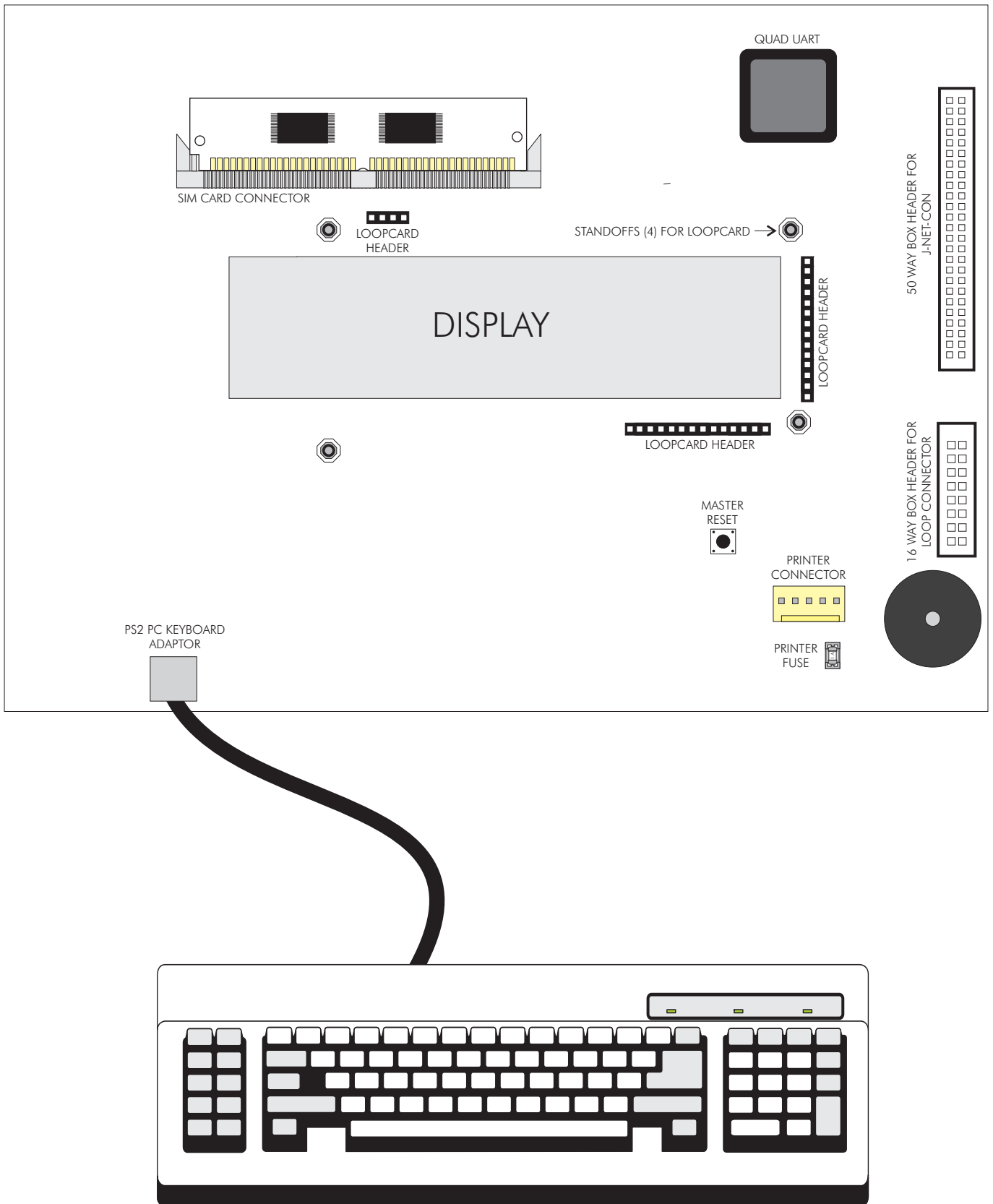

The IR Keypad is typically the most convenient method to program the system. The sensor for the IR Keypad is just below the SOUND ALARMS button on the Main Panel and on a Repeater. Each time a key is pressed on the IR Keypad the Main Panel will beep.

If no beeps are audible then check the batteries in the IR Keypad.

The IR Keypad uses 2 x AAA batteries.

### The IR Keypad Keys

To access the characters in RED, first press the SHIFT KEY. To return to the characters in BLACK press the SHIFT KEY again.

Each time a key press is received by the panel the panel emits a beep. The beeps when SHIFT is on are of a higher pitch than when SHIFT is off.

0-9 are used to input numbers

▲ and ▼ are used to select items

B-SP and ► are used to change fields (move the cursor)

+/- are used to select the loop

ENTER is used to select items and to store changes

ESC is used to abort changes and exit

HOME is often used to go back to the start of a function

Pressing both EXIT keys exits programming mode.

### Help

Where possible help is displayed automatically. However additional help is sometimes available if you press the help key ':' the colon.

The first press will display help for 7 seconds, a second press will ensure the help is displayed for 20 seconds. Pressing any key whilst help is displayed will clear the help but this key press will be ignored.

## Logging In

To enter programming mode you need to log in.

The Main Panel must be powered up and must have initialized itself i.e. NOT be showing the 'INITIALIZING' message.

Press OK/ENTER on the panel's keypad, IR Keypad (or keyboard). You must now input your unique customer access code (supplied with the panel). You have unlimited attempts but if code entry is not started within 10 seconds then the panel will revert back to it's default screen. While entering the code you are allowed up to 5 seconds between key presses.

## Function Selection

The programming functions are arranged using a menu system.

To select a function or sub-menu use either ▲ ▼ and ENTER or 0-9 and ENTER.  
HOME takes you to "1-Review".  
ESC takes you up a menu level.

Any number presses (0-9) will append a digit to what you see unless :

- 1) You are at the very top (1- Review) then the first press selects the first digit.
- 2) You are at the bottom then the press replaces the last digit.

The top level menus are:

- 1 Review Historic Log
- 2 Text Descriptions & Names
- 3 Zones - Disable & Assign
- 4 Sounders - Disable & Assign
- 5 Input/Output - Disable & Assign
- 6 Device Set-up
- 7 Monitor Device Counts & Test
- 8 General

Most functions operate in a consistent manner using the standard keys. The item that is being changed is usually highlighted with a flashing cursor.

## Getting The System Running

Ensure all Sub-panels and Repeaters have unique addresses. Ensure all connectors are firmly in place. Ensure that all connections are tight, with no stray strands of wire. Ensure that the SIM CARD is securely fitted in all Main Panels, Repeaters and Standard Sub-panels

Power up all External Sub-panels and Repeaters then power up the Main Panel.

Ensure that the Main Panel is in Installation Mode (SYSTEM ON LED flashing). If not enter programming mode and select function 8-4-1 Active/Installation Mode and put the panel into Installation Mode.

Press SYSTEM RESET.

### Communications Check

Confirm that all standard Sub-panels have a solid green COMMS OK LED.

If the COMMS OK LED is flashing then there is no communication (via the Data Loop) to the Main Panel.

If the COMMS OK LED is solid green and the sub-panel has no other faults then the amber LOCAL FAULT LED should be extinguished. If the LOCAL FAULT LED is lit then information on the fault should be available at the Main Panel.

Confirm that all Repeaters are showing identical information (LEDs and LCD) to that displayed by the Main Panel.

### Main Panel Check

Press and hold LAMP TEST on the Main Panel.

All the LEDs should light, the LCD backlight should turn on and all pixels on the LCD should be black. (See below.)

All the LEDs shown in this drawing ( ● ● ● ) should be illuminated. Release the LAMP TEST switch to end the test, all LEDs should extinguish except SYSTEM ON and any active indications

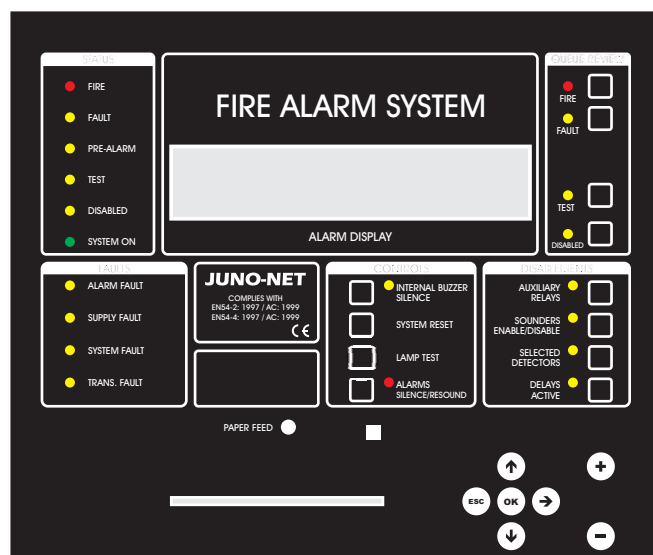

## Learning Which Devices Are Fitted

Enter programming mode.

If site specific data has NOT been pre-programmed then select function 8-3-1 Clear Customer Flash Memory and clear the customer flash. (You must NOT do this if you have been supplied with a SIM CARD pre-programmed with your site data.)

Select function 8-3-2 Clear Non-Volatile RAM and clear the NVRAM.

Exit Programming mode.

Press SYSTEM RESET.

Wait 90 seconds for the system to automatically learn which devices are present and report any faults.

(A SYSTEM RESET or Master Reset in Installation Mode results in an analogue loop power off period of 8 seconds [reset], an analogue loop charge up of 15 seconds then commencement of loop polling.

Review the faults (using the FAULT (QUEUE REVIEW) key if there is more than one). Note down the messages then remove power and rectify the faults.

Power up the system, let it initialize and enter programming mode.

Select function 7-1 Device Count, Type and Value

Using the +/- keys to select the loop number and 0-9 or ▲▼ to select the device confirm that all Sub-panels and devices are present.

Once all faults have been cleared and the system has been in Installation Mode for 90 seconds then the system can be put into Active Mode.

Note that there is no clear end to Installation mode because the system is constantly looking and learning. However if the system is put into Active Mode and Installation Mode hasn't had time to identify all system components you will very quickly be greeted with error reports regarding unexpected devices.

If devices are ever removed, replaced or added then Installation Mode must be selected so that the system can learn the new configuration. If you do not do this the system will report a fault.

**Note** - New SAM's (Self Addressable Modules) need a different installation process because they need to be assigned addresses before the panel can learn that they are present. This procedure is covered later in this manual in the section entitled "6-4 Automatic Address Setting (SAM)".

### Sounder Audibility Check

If the building is unoccupied then press SOUND ALARMS. All sounders should operate until the button is pressed again. Confirm that this is the case.

Note that Apollo loop sounders may take a second or two to respond.

If the building is occupied it is strongly recommended that the test sounders functions in programming mode are used. Enter programming mode and select 7-2 Test Sounders. Using this function, all the sounders can be checked.

### Main Panel

The Main Panel Conventional Sounders will sound for 1 second then be silenced for 9 seconds.

### Standard Sub-panels

Conventional Sounders and Loop Sounders are operated for 1 second then silenced for 9 seconds.

### Integrated Sub-panels

Conventional Sounders and Loop Sounders are operated for 1 second then silenced for 9 seconds.

Conventional Sounder operation for a Repeater with Integrated Sub-panel will be synchronized to the Loop Sounder operation.

Analogue Loop Monitoring

Check that a short circuit or open circuit is detected on every Analogue Loop.

Open Circuit Test

Disconnect either the + or the - OUT connection for each Analogue Loop in turn. The connections will be found on the ANALOGUE LOOP CONNECTION BOARD in Main Panels and Repeaters or directly on Standard Sub-panels.

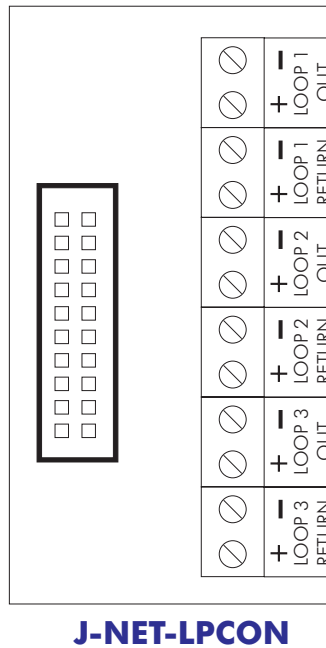

Within a few seconds a circuit fault should be reported for every loop that has been disconnected. No individual detector faults should be reported. On standard sub-panels the amber LOCAL FAULT LED should also be illuminated.

Reconnect the wires and press SYSTEM RESET to clear the fault reports.

## Conventional Sounder Monitoring

Main Panels and Repeaters with Integrated Sub-panels have two Conventional Sounder circuits. Standard Sub-panels have two Conventional Sounder circuits.

Check the Conventional Sounder circuits for open and short circuit fault detection.

To perform the Open-Circuit test, disconnect either the + or - connection at each conventional sounder circuit.

To perform the Short-Circuit test, connect for each sounder circuit a wire link, connecting both the + and - terminals together.

With either test, after a few seconds, a fault message will appear on the LCD display of both the main panel and repeater(s) indicating that the conventional sounder circuit is at fault.

Both the FAULT and ALARM FAULT Led indicators will be lit.

On standard sub-panels the amber LOCAL FAULT Led will also light up.

Restore the original connections and press SYSTEM RESET to clear all the error reports.

**Warning** - if the Conventional Sounder outputs are short circuited while the sounders are active, the electronic overload protection is tripped and the system will report a sounder fault illuminating the ALARM FAULT LED simultaneously. Once the short circuit is cleared, a system reset will clear the faults.



## Detector Tests

If the devices have been assigned to Zones (on a pre-programmed SIM CARD or via the programming menus) then it is possible to test the detectors with limited or no sounder operation.

### Detector Tests By Zone

Before starting clear all faults, put the system into Active Mode, and press SYSTEM RESET.

Enter programming mode and select function 7-3 Sounders on Test Activation. This allows you to choose an audible confirmation that a device has detected a fire. The audible confirmation consists of a 1 second period of sounder operation.

ALL SOUNDERS ON DETECTOR TEST activates the Main Panel Conventional Sounders and all Conventional Sounders and Loop Sounders on the Sub-panel under test.

SUB\_PANEL SOUNDERS ON DETECTOR TEST only operates the Conventional Sounders and Loop Sounders on the Sub-panel under test. I.e. The Sub-panel that the detector under test is physically connected to.

Now select function 7-4 Test Zones to select the Zones which will be tested.

Exit programming mode, but DO NOT press SYSTEM RESET as this clears all test modes.

In test mode whenever a detector is activated the LED on that detector will be illuminated and the event will be reported on the main panel for 15 seconds. If selected, the sounders will also operate for 1 second.

Pressing TEST (QUEUE REVIEW) will report the Zones that are in Test Mode.

### Unassigned Detector Tests

If the detectors have not been assigned to a Zone then they can only be tested in normal (Active) mode. Using the programming menu ensure the system is set to Active Mode then exit programming mode and press SYSTEM RESET.

Carry out a fire test on each detector. Confirm the LED lights on the detector under test. Confirm that the fire is reported correctly at the Main Panel (and any Repeaters). Confirm that the sounders operate.

Note that sounders and detectors can be inhibited or delayed using the advanced features in the programming menus. If the sounders do not operate as expected first verify all the settings for the sounders and the device under test.

## **Wrapping Up Installation And Commissioning**

At this stage you may program the more advanced features of the system. The basic minimum usually involves assigning text labels to the device and Zones.

Once you have completed this or if you have a pre-programmed SIM CARD then do not forget to carry out the following steps:

Connect the batteries to the Main Panel, Repeaters and Sub-panels as described in the Installation section of this manual.

Test that the battery monitoring is functional by temporarily removing the blue wire between each pair of batteries. After a few seconds the fault should be reported on the Main Panel and Repeaters. Standard Sub-panels will also illuminate the amber LOCAL FAULT LED. (See below for more details on the test.)

When the blue wires are reconnected pressing SYSTEM RESET should clear the fault report.

Test that the primary supply monitoring is functional and that the battery system works. Switch off the AC supply to each power supply unit in the system (Main Panel, Repeaters and separate Standard Sub-panels). After a few seconds the fault should be reported on the Main Panel and Repeaters. Standard Sub-panels will also illuminate the amber LOCAL FAULT LED. (See below for more details on the test.)

Reconnect all AC supplies and press SYSTEM RESET.

Confirm that the system is in Active Mode - the SYSTEM ON LED is permanently lit.

Close the Main Panel and Repeater remembering to fit the three fascia panel retaining screws.

Close the panel box doors and lock them.

Give the keys to the person responsible for the fire alarm system.

Battery Fault Message Test

This test should be performed for each set of batteries. Test only the actual battery connections.

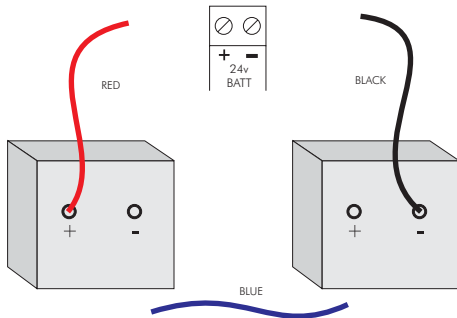

Remove the blue link from between the 2 batteries

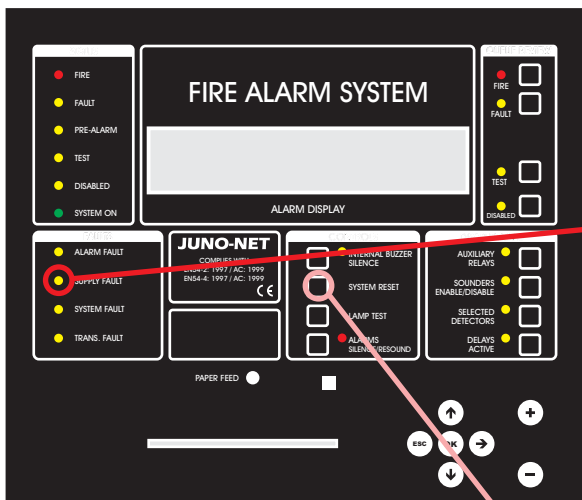

After a short delay, the SUPPLY FAULT LED illuminates, the panel buzzer sounds and the "Battery Fault" message appears on the LCD Display.

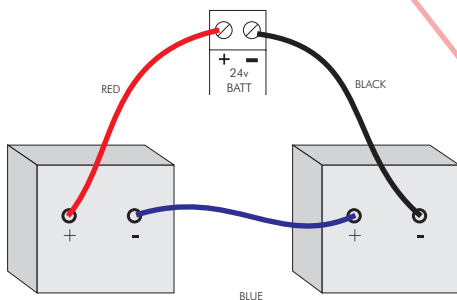

Replace the link between the batteries and reset the panel (SYSTEM RESET) to clear the fault indication.

For distributed systems, to save time from going to the main panel display, check instead that the FAULT LED on the sub-board is illuminated amber. This will remain illuminated after reconnecting the batteries, so when all sub-panels have been checked, press SYSTEM RESET.

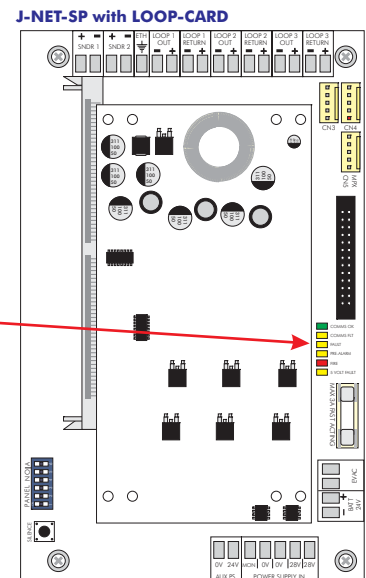

## Power Failure Test

Carry out this test to check that the battery system works correctly when mains power fails.

Switch off the mains supply to the panel. After a short delay, the SUPPLY FAULT LED illuminates amber and the LCD displays the message "Primary Supply Fault". The fault buzzer sounds.

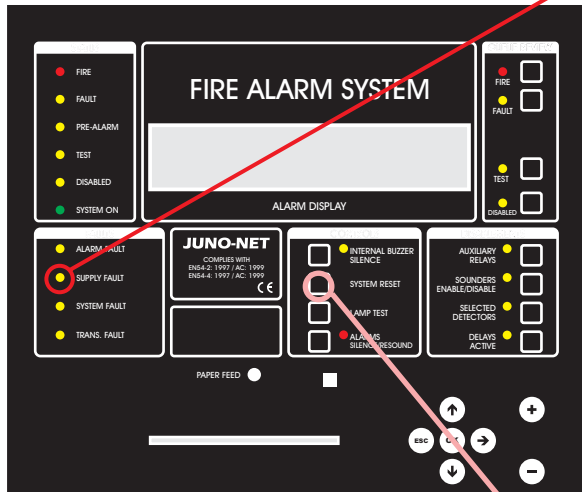

Switch the mains supply back on and press the SYSTEM RESET switch. The SUPPLY FAULT LED extinguishes, the fault message is removed from the LCD, and the buzzer stops sounding.

## Master Reset

A Master Reset is not accessed through the programming menus. It occurs automatically when the Main Panel power is cycled (both primary and secondary supplies removed and reconnected). It also occurs when the PCB mounted push button fitted on the rear of the Main Panel main PCB is pressed.

A Master Reset (re)sends all settings to all sub-panels. Settings are otherwise only sent to sub-panels when they are changed using the programming functions.

When no detectors are isolated the Master Reset settings download will complete within 15 seconds (even with 32 sub-panels connected). This therefore happens whilst the INITIALIZING message is being displayed. In the worst case (where 32 sub-panels are connected, all loops are fully populated and all detectors are isolated) this download will take 240 seconds.

In parallel with the settings download the sub-panels will power off their analogue loops for a period of 8 seconds [reset] then allow an analogue loop charge up of 15 seconds before commencement of loop polling.

### JUNO-NET MOTHERBOARD (BACK VIEW)

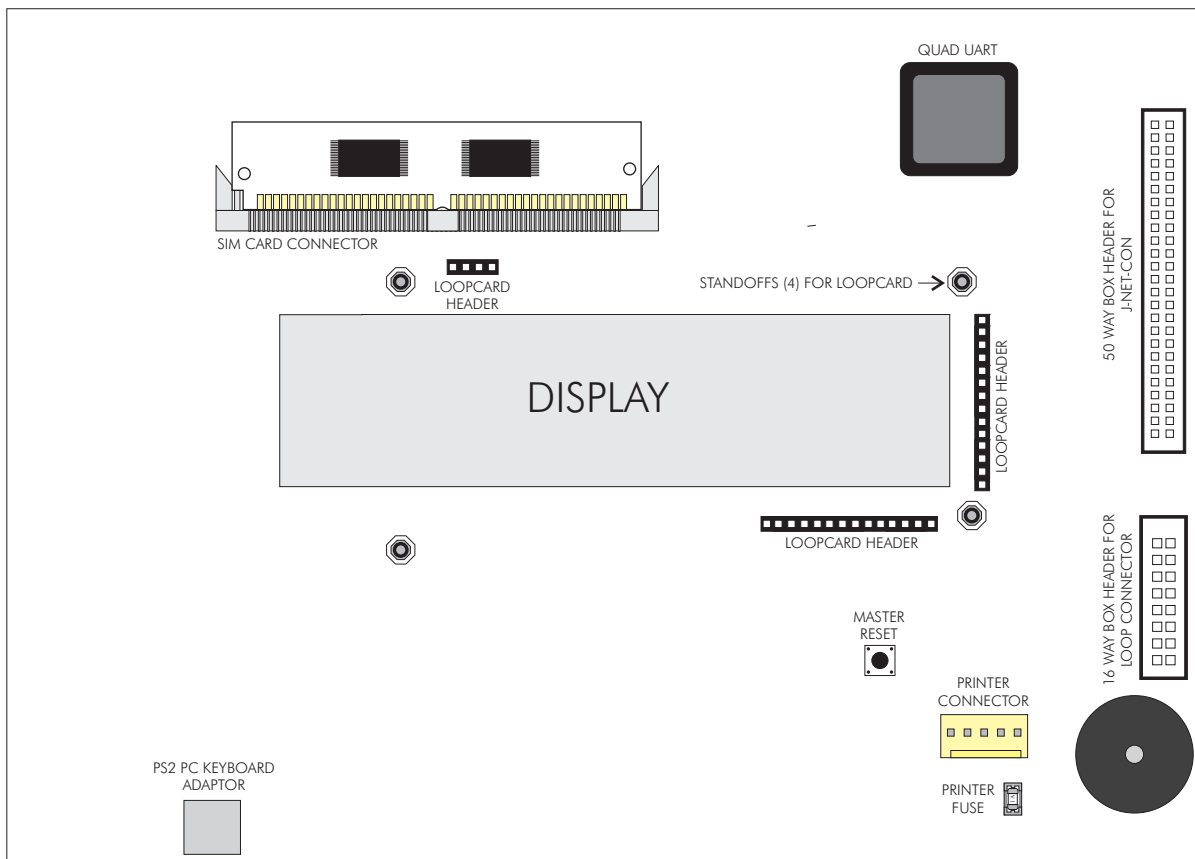

There are a number of programming functions that allow you to configure your system so that it operates exactly as you require.

### **Programming Functions General**

#### Complete List Of Functions

## **1 Review Historic Log**

- 1-1 Display Historic Log
- 1-2 Print Historic Log Entries
- 1-3 Clear Historic Log
- 1-4 Print Loop/Device Set-up
- 1-5 Read/Clear Autostart Count

## **2 Text Descriptions & Names**

- 2-1 Enter Device Text
- 2-2 Enter Zone Text
- 2-3 Enter Company Name

## **3 Zones - Disable & Assign**

- 3-1 Disable Zones
- 3-2 Assign Sounder Groups to Zones
- 3-3 Assign I/O Groups to Zones
- 3-4 Assign Zone to Device
- 3-5 Zone Sounder Delay Set-up
- 3-6 Zone Fire Brigade Delay Set-up
- 3-7 Set BMS Zone Numbers

## **4 Sounders - Disable & Assign**

- 4-1 Sounder Configuration
- 4-2 Configure Sounder Groups
- 4-3 Disable Sounders
- 4-4 Assign Sounder Group to Device
- 4-5 Inhibit Sounders for Device
- 4-6 Sounder Delay Set-up
- 4-7 Override Sounder Delays

## **5 Input/Output - Disable & Assign**

- 5-1 Configure I/O Groups
- 5-2 Select Fault I/O Group
- 5-3 Assign I/O Group to Device
- 5-4 Inhibit I/O for Device
- 5-5 I/O Unit Action upon Evacuate
- 5-6 I/O Unit Delay or Immediate
- 5-7 I/O Delay Set-up

## 6 Device Set-up

### 6-1 General

- 6-1-1 Disable Loops
- 6-1-2 Device Disable
- 6-1-3 Set Selective Disablement
- 6-1-4 Set Device Reporting Details
- 6-1-5 Set Immediate Evacuate for Device
- 6-1-6 Device Activation Overrides Delays
- 6-1-7 Inhibit Auxiliary Relays
- 6-1-8 Global Sensitivity Set-up
- 6-1-9 Configure Timed Sensitivity

### 6-2 Other Device Options

- 6-2-1 Select Device Heat Grade
- 6-2-2 Select Device Smoke Sensitivity

### 6-3 **Removed - Not a valid function**

### 6-4 Automatic Address Setting (SAM)

- 6-4-1 Activate ASET Mode (SAM)
- 6-4-2 Clear Loop
- 6-4-3 Clear Device

## 7 Monitor Device Counts & Test

- 7-1 Device Count, Type & Value
- 7-2 Test Sounders
- 7-3 Sounders on Test Activation
- 7-4 Test Zones
- 7-5 Sub-Panel LED Test
- 7-6 Light LED on device

## 8 General

### 8-1 Time/Date & Timers

- 8-1-1 Set Date & Time
- 8-1-2 Define Day & Night
- 8-1-3 Delays Off at Night
- 8-1-4 Configure Evacuate Timer
- 8-1-5 Device Starts Evacuate Timer
- 8-1-6 Fire Brigade Delay Set-up

### 8-2 Special Features Set-up

- 8-2-1 Two Devices to Evacuate
- 8-2-2 Call Points to Evacuate

### 8-3 Memory - BEWARE, ENGINEERS ONLY

- 8-3-1 Clear Customer Flash Memory
- 8-3-2 Clear Non-Volatile RAM
- 8-3-3 Calculate Customer Flash Checksum
- 8-3-4 Calculate Program Flash Checksum

### 8-4 Other Features

- 8-4-1 Active/Installation Mode
- 8-4-2 Upload/Download Link to PC
- 8-4-3 Printer Disable/Enable
- 8-4-4 Set User Access Code
- 8-4-5 Set User Functions
- 8-4-6 Select language
- 8-4-7 **Removed - Not a valid function**
- 8-4-8 Set Installer Access Code

### 8-5 Remote Access and Monitoring

- 8-5-1 Configure PC Graphics Interface
- 8-5-2 Modem Dial Out Number
- 8-5-3 Modem Initialization String



## Keys To Use Within Functions

Most functions use some or all of the following keys:

0-9 are used to input numbers

▲ and ▼ are used to browse through items

B-SP (Back Space) and ► are used to change fields (move the cursor)

+/- are used to select the loop

ENTER is used to select items and store changes

ESC is used to abort changes and exit

HOME is often used to go back to the start of a function

The cursor is often used to highlight the item that is being changed.

## Help

Where possible help is displayed automatically. However additional help is sometimes available if you press the help key ':' the colon.

The first press will display help for 7 seconds, a second press will ensure the help is displayed for 20 seconds. Pressing any key whilst help is displayed will clear the help and the key press will otherwise be ignored.

## QUART

The QUART (Quad Universal Asynchronous Receiver Transmitter) is an optional part that is necessary for operation of the following:

Printer  
BMS (Building Management System)  
PC Graphics Software output  
Modem

If the QUART is not fitted then access will automatically be denied to the programming functions that require it.

## General

Because of the flexibility and functionality of this panel it can sometimes be quite hard to establish your desired configuration. Zone, device and group events interact as do the various timers.

If the system does not seem to operate as intended please take your time and review the various sections in this manual. Some settings need the front panel buttons to be activated whilst others can be inhibited for specific devices.

The basic functionality of the panel is readily available and the fire alarm system will be operational just by supplying it with electrical power. Exercising cause and effect capability is what this section is all about. The best way to become familiar with all the programming facilities of this panel will be a hands-on approach aided closely by this manual.

**Note** - if a fire occurs whilst the panel is in programming mode then programming mode will automatically be exited. If a fault occurs whilst in programming mode the fault will be reported but it is necessary to manually exit programming mode to read the fault details on the LCD.

## **Specific Functions**

### **1 Review Historic Log**

All the functions associated with reviewing or printing events and settings.

#### **1-1 Display Historic Log**

The panel logs all events in an internal event log. It can store a rolling 2000 entries. When it is full the latest entry is added and the oldest entry discarded.

Help is automatically displayed on entry to the function because it is not possible to display a log entry and help at the same time.

To select a specific entry, input the number and then press ENTER.

#### **1-2 Print Historic Log Entries**

Select which entries you wish to print and press ENTER.

If the printer is already in use it is necessary to wait until the printer is free before starting a new print job.

If you wish to stop a printout enter the function again and you will be given the option of canceling the printout.

This function cannot be accessed remotely (from a Repeater or the PC Graphics Interface).

Nothing will be printed if the printer is disabled by (function 8-4-3).

Note that once the log is full the log entry number (0001 - 2000) will change for each logged event but log entry 0001 will be the oldest entry and 2000 will be the most recent.

#### **1-3 Clear Historic Log**

Clears the Historic Log.

#### **1-4 Print Loop/Device Set-up**

Prints all the device information for the specified Analogue Loop. The information printed includes the device address, type, zone, text label and whether it is currently disabled.

If the printer is already in use it is necessary to wait until the printer is free before starting a new print job.

If you wish to stop a printout enter the function again and you will be given the option of canceling the printout.

This function cannot be accessed remotely (from the PC Graphics software or a Repeater).

Nothing will be printed if the printer is disabled by (function 8-4-3).

#### **1-5 Read/Clear Autostart Count**

Every time the Main Panel has a Master Reset or it's power is cycled the Autostart count is incremented. SYSTEM RESETs from the front panel button do not increment the Autostart count.

## 2 Text Descriptions & Names

All the functions associated with textual labels or names.

### 2-1 Enter Device Text

First select the device then input the text label for that specific device. If the IR keypad is being used, to enter letters rather than numbers press the SHIFT key momentarily.

If the device already has a text label it will be displayed and can be edited if required.

Each device can have a label of up to 22 characters.

- ▲ Clears the text to the right of the cursor
- ▼ Gets the text for the previous device

HOME takes you back to the start of the text

DELETE (PS2 Keyboard only) deletes the character under the cursor

The device text is displayed in the event of a fault, fire or pre-alarm. The text is also shown when the event log is reviewed or printed.

### 2-2 Enter Zone Text

First select the Zone then input the text label for that Zone. If the IR keypad is being used, to enter letters rather than numbers press the SHIFT key momentarily.

If the Zone already has a text label it will be displayed and can be edited if required.

Each Zone can have a label of up to 16 characters.

The Zone text is displayed in the event of a fault, fire or pre-alarm. The text is also shown when the event log is reviewed or printed.

### 2-3 Enter Company Name

Allows the company or building name to be entered.

The name can be up to 28 characters long and will be automatically centered when it is displayed.

The company name is displayed above the date and time whilst the system is not in an alarm or fault state.

The company name also forms the header on the printout after a SYSTEM RESET.

## 3 Zones - Disable & Assign

All the functions associated with managing Zones

### 3-1 Disable Zones

Allows you to disable or enable Zones.

All devices in disabled Zones will cease to operate with the exception of the (audible) output from loop sounders.

Any Zones that are disabled will also be indicated when programming mode is exited. They can then be reviewed using the DISABLED (QUEUE REVIEW) button.

### 3-2 Assign Sounder Groups to Zones

Sounder Groups (set up using the Sounders programming functions) can be assigned to Zones.

Each Zone can be assigned two sounder groups. The first Sounder Group is activated when the first fire is detected, the second Sounder Group is activated when a second fire is detected in the same Zone.

### 3-3 Assign I/O Groups to Zones

I/O Groups (set up using the I/O programming functions) can be assigned to Zones.

The first 4 I/O groups are activated when the first fire is detected, the 5th I/O group is activated when a second fire is detected in the same Zone.

The details of the activation are set up using the I/O programming functions.

### 3-4 Assign Zone to Device

Allows the detection Zone to be defined.

Select which devices make up which Zones. If a device has a text label it will be displayed. If a Zone has a text label it will also be displayed.

Up to 384 Zones can be defined.

Zone 000 is not a Zone and indicates no Zone has been assigned.

### 3-5 Zone Sounder Delay Set-up

Allows the sounder activation delay to be enabled or disabled for each specific Zone.

Note that this delay will only occur if the following has also been set:

- Sounder programming function 4-6: The sounder delay period is set, the delay is set to ZONAL MODE and the devices that initiate the delay have been specified.
- The front panel ACTIVE DELAYS button has been set to on (LED lit).

**Note** - specific devices in the Zone can be set to override this delay.

### 3-6 Zone Fire Brigade Delay Set-up

Allows the Fire Brigade signal delay to be turned on or off for a specific Zone.

**Note -** the Fire Brigade Delay Mode (function 8-1-6) must be set to ZONAL for this function to have an effect.

### 3-7 Set BMS Zone Numbers

Allows a BMS (Building Management System) Zone to be attached to a fire system Zone.

## 4 Sounders - Disable & Assign

### 4-1 Sounder Configuration

Allows selection of PRESET or PROGRAMMED sounder operation.

Selecting PRESET (the default) will result in all sounders being operated; any Sounder Group settings will be ignored.

**Note** - the Sounder Groups must be defined before PROGRAMMED is selected because the default group settings have all sounders set to silent.

**Note** - PRESET or PROGRAMMED does not affect any sounder delay settings.

### 4-2 Configure Sounder Groups

Allows all the Sounder Groups to be defined. A Sounder Group can consist of any combination of sounders. 512 Sounder Groups can be defined.

First select the Sounder Group number then work your way through each panel.  
For each panel you can select how each sounder reacts when that sounder group is activated.

For each sounder:

'C' indicates continuous operation.

'S' indicates silent (no) operation.

'P' indicates pulsing operation.

As you select different panels you will automatically only be offered the sounders that the particular panel can support (although they may not physically be fitted).

Panel 00 corresponds to the main panel's conventional sounder circuits.

Group 512 is the Common Sounder Group. This is always operated when Sounder Group operation is turned on and a fire occurs.

When a fire occurs all the Sounder Group information for the detector in fire is combined: the device Sounder Group is combined with the Zone Sounder Group and the Common Sounder Group. 'P' pulsing will override 'S' silent and 'C' will override 'P' pulsing.

When a subsequent fire occurs the new Sounder Group information is added to the existing Sounder Group information. 'P' pulsing will override 'S' silent and 'C' will override 'P' pulsing.

**Note** - if Sounder Groups are defined then it is essential to set 4-1 Sounder Configuration to PROGRAMMED, otherwise, all the system sounders will be activated by any fire event.

**Note** - individual detectors can be set not to activate Common Sounder Groups, Zone Sounder Groups or all sounders. See function 4-5 Inhibit Sounders for Device.

**Note** - if evacuate is operated (by setting CALL-POINTS to evacuate, then activating a CALL-POINT, for example) the sounders will operate as if the sounder configuration were set to PRESET.

**Note** - there is not room on the display to display help whilst using this function but help is available, as usual, by pressing ':', the colon key.

### 4-3 Disable Sounders

Allows specific sounders to be disabled or Enabled.

Disabled sounders will not be operated regardless of Sounder Configuration, Sounder Groups and evacuate requests.

'E' indicates enabled  
'D' indicates disabled

As you select different panels you will automatically only be offered the sounders that the particular panel can support (although they may not physically be fitted).

When programming mode is exited all sounders that have been disabled can be reviewed using the DISABLED (QUEUE REVIEW) button.

**Note** - there is not room on the display to display help whilst using this function but help is available, as usual, by pressing ':', the colon key.

### 4-4 Assign Sounder Group to Device

Allows a Sounder Group to be assigned to a detector. When the detector goes into alarm then the assigned Sounder Group will be activated (Sounder Groups only function when Sounder Configuration is set to PROGRAMMED).

**Note** - when a fire occurs all the Sounder Group information for the detector in fire is combined: the device Sounder Group is combined with the Zone Sounder Group and the Common Sounder Group. 'P' pulsing will override 'S' silent and 'C' will override 'P' pulsing.

**Note** - do not use this function to assign sounders to Sounder Groups; it will have no effect. Assign sounders to Sounder Groups using function 4-2 Configure Sounder Groups.

### 4-5 Inhibit Sounders for Device

Allows a device to be set so that it does not operate certain Sounder Groups. (Sounder Groups only function when Sounder Configuration is set to PROGRAMMED).

The options are:

COMMON	The Common Sounder Group (512) is not activated when the device detects fire
ZONAL	The Zone Sounder Group for the device is not activated when the device detects fire
ALL	No sounders are activated when the device detects fire

Inhibiting all sounders for a device will inhibit all sounders even if the Sounder Configuration is set to PRESET.

COMMON or ZONAL inhibits will not inhibit the Sounder Group directly assigned to a device (function 4-4 Assign Sounder Group to Device) if that device detects fire.



## 4-6 Sounder Delay Set-up

Allows the sounder delay to be set-up:

The sounder delay can be set to GLOBAL MODE, ZONAL MODE or DISABLED.

The sounder delay period is defined (to a maximum of 10 minutes).

The devices that initiate a delayed sounder activation are specified.

If the function is set to ZONAL MODE it is also necessary to set up the activation using Function 3-5 Zone Sounder Delay Set-up.

The options for initiation are:

CALL POINTS ONLY - call-points start the delay timer. The sounder groups associated with the activated call-point will be queued for delayed activation. Other devices will **not** start the delay timer and will activate their sounder groups immediately.

DETECTORS ONLY - detectors start the delay timer. The sounder groups associated with the activated detector will be queued for delayed activation. Call points will **not** start the delay timer and will activate their sounder groups immediately.

ANY DEVICE - any device will start the delay timer. The sounder groups associated with the activated device will be queued for delayed activation.

For sounder delays to operate the front panel ACTIVE DELAYS LED has to be lit.

There is only one sounder delay timer so when this expires any further sounder activations will be immediate.

If ALARM SILENCE is pressed when there are sounders queued for delayed activation the queued sounders are also silenced (stopped from sounding). Once the first alarm has been silenced by pressing ALARM SILENCE all subsequent fires will be reported immediately (the sounder delay settings will be ignored).

**Note** - specific sounders (function 4-7) and specific detectors (function 6-1-6) can be set to override this delay.

## 4-7 Override Sounder Delays

Allows specific sounders to activate immediately even if the system has been set with sounder delays active.

As you select different panels you will automatically only be offered the sounders that the particular panel can support (although they may not physically be fitted).

0 indicates normal operation

X indicates that the specific sounder will operate immediately

Sounders set to immediate will also override any Sounder Group settings for that specific sounder. Sounders set to immediate operation will sound continuously (pulsing settings will be overridden).

## 5 Input/Output - Disable & Assign

Input/Output Analogue Loop device management.

### 5-1 Configure I/O Groups

Allows an I/O Group to be established. The I/O Group can then be used for fire or fault reporting. 512 I/O Groups can be defined.

First select the Group number then assign the I/O loop addresses..

Each I/O Group can have up to 32 I/O units. (256 for the Common I/O Group)(Group 512).

I/O Group 512 is the Common I/O group. The Common I/O Group is always activated when a fire occurs.

When a fire occurs all the I/O information for the detector in fire is combined: the device I/O Group is combined with the Common I/O Group and the four 'first fire' Zone I/O Groups.

When a subsequent fire occurs in the same Zone the 'second fire' Zone I/O group is activated.

Upon a fire the I/O operations are cumulative.

**Note** - specific devices can be set not to activate I/O (including Common I/O) - function 5-4 Inhibit I/O for Device.

### 5-2 Select Fault I/O Group

Allows a specified I/O group to be activated if a fault condition occurs.

It is not recommended to use the same I/O group for fire and fault reporting.

### 5-3 Assign I/O Group to Device

Allows an I/O Group to be assigned to a detector. When the detector goes into alarm then the assigned I/O Group will be activated.

**Note** - when a fire occurs all the I/O information for the detector in fire is combined: the device I/O Group is combined with the Common I/O Group and the four 'first fire' Zone I/O Groups.

This function can be used to assign an I/O module (input) to activate an I/O Group output. The I/O Group output could be on the same I/O module, another I/O module or a group of I/O modules.

### 5-4 Inhibit I/O for Device

Allows a device to be set so that it does not operate certain I/O Groups.

The options are:

COMMON	The Common I/O Group (512) is not activated when the device detects fire
ZONAL	The Zone I/O Group for the device is not activated when the device detects fire
ALL	No I/O Groups are activated when the device detects fire

COMMON or ZONAL inhibits will not inhibit the I/O Group directly assigned to a device (function 5-3 Assign I/O Group to Device) if that device detects fire.

### 5-5 I/O Unit Action upon Evacuate

Allows you to define how an I/O module will perform when an evacuate is signaled. By default an I/O module will not activate unless it has been assigned to an I/O Group that has been activated.

**Note** - an evacuate is not considered as an automatically detected fire event.

### 5-6 I/O Unit Delay or Immediate

Allows a specific I/O module to be set so that it activates immediately even if the rest of the I/O is set to be activated after a delay.

### 5-7 I/O Delay Set-up

Allows the I/O (output) delay to be set. This delay applies to all I/O module outputs.

The maximum delay that is allowed is 10 minutes.

There is only one I/O timer so once it has expired events activating further delayed I/O groups will cause immediate I/O operation.

**Note** - delays will only occur if front panel ACTIVE DELAYS button has been set to on.

**Note** - specific I/O modules (function 5-6) and specific detectors (function 6-1-6) can be set to override this delay.

## 6 Device Set-up

Allows specific settings to be selected for individual Analogue Loop devices.

### 6-1 General

Settings common to all types of Analogue Loop devices.

#### 6-1-1 Disable Loops

Allows a specific Analogue Loop to be disabled or enabled. The default is enabled.

All devices on disabled loops will cease to operate with the exception of the (audible) output from loop sounders.

Any loops that are disabled will also be indicated when programming mode is exited. They can then be reviewed using the DISABLED (QUEUE REVIEW) button.

#### 6-1-2 Device Disable

Allows a specific device to be disabled or enabled. The default is enabled.

Disabled devices have both inputs and outputs disabled.

This function does not disable the (audible) output from loop sounders.

Any devices that are disabled will also be indicated when programming mode is exited. They can then be reviewed using the DISABLED (QUEUE REVIEW) button.

#### 6-1-3 Set Selective Disablement

Allows a specific device to be set up for selective disablement.

The device is only disabled when the SELECTED DETECTORS (DISABLEMENTS) button on the front panel is activated.

This function is intended for use when certain detectors regularly need disabling but are not necessarily in the same Zone.

Outside programming mode any devices that are currently disabled can then be reviewed using the DISABLED (QUEUE REVIEW) button.

### 6-1-4 Set Device Reporting Details

Each detector can be set to:

FIRE  
FAULT  
PRE-ALARM

The default is FIRE reporting.

When the device is activated or reaches its alarm threshold then the event is reported in accordance with this setting.

Primarily intended for use with Input modules, it can allow activation of one input to trigger a fault report rather than a fire.

**NOTE:** Transparency Configuration was added to this function. This configuration is ONLY applied to Input/Output or Input units. It is not compliant to EN54.

### 6-1-5 Set Immediate Evacuate for Device

When a detector set to immediate evacuate reports a fire all Sounder Group settings are ignored. All sounders are operated immediately as if the Sounder Configuration was set to PRESET and all delays are ignored.

**Note** - disabled sounders will not sound.

### 6-1-6 Device Activation Overrides Delays

Allows a detector to be set to override all zonal and global sounder, Fire Brigade Transmission and I/O delay timers. When this device is activated the Fire Brigade Transmission is activated immediately and the Sounder Groups and I/O Groups associated with this device are also activated immediately (even if they were already queued for delayed activation).

However this device will not start any of the timers either which means that subsequent fires reported from other detectors may experience the full delay duration (as programmed).

### 6-1-7 Inhibit Auxiliary Relays

Allows a specific detector to be set to not operate system I/O's when it reports a fire. (Equivalent to pressing auxiliary relays disablement button.)

### 6-1-8 Global Sensitivity Set-up

This function selects the sensitivity of all the detectors that have been set to GLOBAL SENSITIVITY.

Different settings can be entered for weekdays and for Saturday and Sunday.

Settings are :

HIGH	(Detector alarm threshold of 45)
NORMAL	(Detector alarm threshold of 55)
LOW	(Detector alarm threshold of 65)
TIMED	

If TIMED is selected then the night and day sensitivity settings used are based on whether it is night or day. Set the night and day sensitivities using programming function 6-1-9. Define the time day and night start using programming function 8-1-2.

The Pre-alarm levels are always 10 below the alarm thresholds.

Ensure that the system clock day, date and time are set correctly (function 8-1-1).

Note that in order to keep day/night and day settings consistent a day setting starts at sunrise (which is set by function 8-1-2). This means that, for example, the Saturday setting will start at 8:00 AM on Saturday.

**Note - Detectors set to LOW sensitivity do not meet the requirements of EN54 part 5.**

### 6-1-9 Configure Timed Sensitivity

Allows the sensitivity to be set for day and night.

Settings are :

HIGH	(Detector alarm threshold of 45)
NORMAL	(Detector alarm threshold of 55)
LOW	(Detector alarm threshold of 65)

**Note -** only detectors that have their sensitivity set to GLOBAL SENSITIVITY will have their sensitivity changed, and then only if 6-1-8 Global Sensitivity Set-up has the day set to TIMED.

**Note - Detectors set to LOW sensitivity do not meet the requirements of EN54 part 5.**

## 6-2 Other Device Options

Analogue Loop device settings that relate to a detector's sensitivity for both smoke & heat.

### 6-2-1 Select Device Heat Grade

This function is only applicable to Heat Detectors. It has no effect on other devices.

It allows the alarm threshold for the heat detector to be set.

The default threshold is 55 °C.

The Pre-alarm levels are always 10° C below the alarm thresholds.

### 6-2-2 Select Device Smoke Sensitivity

This function is only suitable for smoke detectors.

It allows the alarm threshold for smoke detectors to be set.

Each individual detector has the following settings:

NORMAL  
LOW  
HIGH  
GLOBAL

If GLOBAL is selected then, depending the day, the appropriate HIGH, LOW, NORMAL or TIMED setting is used (see functions 6-1-8 Global Sensitivity Set-up and 6-1-9 Configure Timed Sensitivity).

HIGH	=	45
NORMAL	=	55
LOW	=	65

The Pre-alarm levels are always 10 below the alarm thresholds.

**Note - Detectors set to LOW sensitivity do not meet the requirements of EN54 part 5.**

## 6-3 - ~~Removed - No longer available~~

## 6-4 Automatic Address Setting (ASET)

### Introduction

Automatic Address Setting (ASET) is a special install and commissioning mode that can be activated on a per loop basis whilst in INSTALLATION mode. ASET mode is only required if Soft Addressable Modules (SAM's) are used in the fire protection system. Soft Addressable Modules (SAM's) do not have their addresses set using switches. They automatically assign their own addresses and ASET mode is used to achieve this.

Because ASET mode requires manual triggering of each device (using the standard test procedure for each one) the installer can effectively choose the address for each detector and simultaneously program and test each device.

SAM'S CAN BE MIXED WITH OTHER TYPES OF DEVICES ON THE SAME LOOP. Each time a SAM is programmed it takes the next free address on its loop.

### General Guidelines

SAM's can only be used in conjunction with:

- a) Juno Net panel.
- b) Juno Net Repeater panel with Integrated Sub-panel
- c) Junior 1-loop panel.
- d) Sub panel (incorporating SIMM module & socket).

Note: Verify panel software version by looking at number on the sticker placed on the SIMM card.

Note: SAM's cannot operate or be programmed when installed within loops associated with old Sub-Panel versions (i.e. Sub-Panels that do not include a SIMM card and socket)

Before starting the programming procedure, care should be taken with the following:

- a) Main Supply OK.
- b) Auxiliary Supply (Batteries) OK.
- c) Loop Supply OK.
- d) Verify the non-existence of earth current leakage.
- e) Verify the cable lengths for the loop.
- f) Confirm the non-existence of short or open circuits within the loop.
- g) Verify communications with standard analogue addressable devices is OK.
- h) Verify communications between Main Panel, Sub-Panels and Repeaters with integrated Sub-Panel.

Verify that all SAM connections, both to the loop and the associated conventional device (i.e. smoke sensor/ detector, call point, etc.) are properly made and that the conventional device connections follow the manufacturer's instructions, in particular those regarding polarity. Reversal of the supply polarity can cause failure or malfunction and prevent a SAM from being programmed.

### **CAUTION**

**Verify that there are no faults or fire conditions in the loop or system.**  
**Clear all fault and fire conditions first.**

**Reset to normal operation all devices before applying power to the panel, in**



In order to initiate the programming procedure of the SAM's the Panel has to be in INSTALLATION MODE. See function 8.4.1.

#### 6-4-1 Activate ASET Mode (SAM) - **Only applies with Wizmart Protocol**

The enabling of this mode is done on a per loop basis. When a loop is in ASET MODE the TEST LED on the Main Panel, will be illuminated. Should there be more than one loop in ASET MODE the TEST QUEUE button on the Main Panel can be used to verify and display loops that are in this mode.

Although the system supports more than one loop being used in ASET MODE it is advisable to work with only one loop in this mode at a time. This could help avoid problems with wrong devices being programmed or erased.

#### **CAUTION**

**A loop while in ASET mode will not offer any kind of protection against fire conditions.**

DO NOT remove or replace SAM's while loop is powered. If one of these modules has to be replaced or removed, first disconnect all supply sources to the panel.

#### **CAUTION**

**Removal of a SAM while loop is powered can corrupt programming of this module and all other SAM's present in the loop.**

#### **Start SAM programming**

Activate a blank SAM by either testing the device associated with it, either using the standard test procedure for the device or by short-circuiting both SAM device wires (i.e. BLACK & RED) simulating in this case a device activation. Smoke and heat detectors will have their alarm led permanently lit when activated. Sounders can be set to activate for approximately 1 second, using function 7.3, every time a new SAM is activated (i.e. fire condition). Upon activation of the conventional device and after a short delay (aprox. 3 seconds), the associated SAM is programmed with the next available address. During this delay the panel will execute a verification, where the new address and device will be confirmed and validated.

The programming of a new address can be monitored in four different ways, namely:

- a) **Using function 7.1**, after a new SAM has been programmed the device count will increase by one and by selecting the newly programmed address, the device type, address and analogue value can also be confirmed.
- b) **Using function 7.3**, the user can select to activate the sounders when a device enters the alarm state. When in ASET mode, the sounders will be activated for approximately one second, each time a device enters the fire condition and a new SAM address has been programmed. This will only affect loops where the ASET MODE was enabled after entering the SOUNDERS ON TEST ACTIVATION mode.
- c) **Using function 1.1**, the log of events can be used to verify the devices that have been programmed.
- d) **Printer output**, when present, its output will show an entry for each device that has been programmed with an indication of device address and type.

**Note:** A programmed SAM that has been RESET and re-enters the fire condition will force the panel to activate the sounders without a new address being programmed. The panel will activate the bells/sounders every time there is a new fire condition, regardless of it being caused by a new address being attributed or not. Each new SAM programming should be confirmed and monitored in order to avoid misleading information originating from SAM's that have already been programmed.

his procedure is then repeated for each blank SAM on the loop. There should be a time interval of approx. 10 seconds between SAM activations.

After every 8<sup>th</sup> SAM activation the panel will reset the loop to clear the latched alarm conditions. When programming SAMs associated with CALL POINTS, the device should be manually reset, with the mechanical means provided by the manufacturer of the device, upon completion of the programming phase. In the case of smoke detectors, they will automatically reset after each loop reset if they are free from smoke. While the loop is in the reset state, no new SAM activations and therefore programming, should be taking place. This period has a duration of approximately 30 seconds.

**Note:** If two SAM's are simultaneously activated neither will be programmed with an address. One SAM must be activated (and programmed) at a time

**Note:** physically removing any device on a loop in ASET mode will free up the device address and the next SAM to be activated could potentially be assigned that address.

Two functions are provided to the installer, should the need arise to clear/ erase any or all SAM modules in a specific loop:

**Function 6.4.2 Clear Loop**

Use this function to clear/ erase all SAM's on the specified loop. Once erased, all SAM's on that loop must be reprogrammed using ASET mode. See function 6.4.1.

**Function 6.4.3. Clear Device**

Use this function to erase a single SAM on a specific loop.

**Note:** An erased/ blank SAM will not offer any fire protection.

**Note:** Both functions will operate even if the chosen loop is not in ASET mode.

After all SAM's have been programmed in a loop, perform a MASTER RESET to the panel followed by a confirmation, using function 7.1, that all devices have been correctly programmed (i.e. device address, type and analogue value).

SAM's will respond with the following fixed analogue values, depending on their state:

	NORMAL	FAULT	ACTIVATED-FIRE
Smoke	20	8	80
Heat	20	8	80
Call Point	20	N/A	64

**UPON COMPLETION OF THE INSTALLATION AND COMMISSIONING STAGES A FIRE DETECTION SYSTEM SHOULD ALWAYS OPERATE IN ACTIVE MODE**

## **TROUBLESHOOTING**

### **a) SAM does not program**

If during the course of programming a SAM, the new address is not programmed in the module, verify that the connections to both the loop and the conventional device are correctly made. Confirm supply polarity of the conventional device. Always follow manufacturer's instructions. Check loop voltage at the SAM terminals followed by a verification of the conventional device voltage, measure voltage across the supply wires (black & red). In normal operation it should always be greater than 16 V DC.

Verify the condition of the whole system in particular supplies (main, auxiliary and loop), earth leakage, loop length too long, loop with a short or open circuit, main panel and sub-panel communications. If all of these are OK then do a system reset after which you should verify, using function 7.1, if there are devices with duplicated address. If there are, clear those addresses and reprogram SAM's that previously had identical addresses.

In the eventuality that one SAM does not program but there is no evidence of two devices having identical addresses after a system reset has been performed, clear the last programmed address using function 6.4.3 and reprogram SAM. If that does not solve problem replace SAM module. Remember that a duplicate address fault will only show with ASET mode disabled.

### **b) SAM with duplicate addresses**

In an installation with SAM's, should there be a fault of 2 devices or more with the same address (duplicate address fault) two actions can be taken:

- 1) CLEAR LOOP. Clear the loop where some SAM's have duplicate addresses. See function 6.4.2. This action should only be applied when in a brand new installation where all SAM's should have been blank (no address programmed).
- 2) Alternatively the duplicated address can be erased using function 6.4.3

Reset the panel and verify, using function 7.1, the offending address and henceforth the associated FAULT condition has disappeared. Re-program cleared devices. Repeat procedure until fault disappears. If after the third time the address clearing procedure has been repeated the fault persists, replace SAM's with duplicate addresses.

It should be observed that this verification can only be performed when ASET mode is disabled, since the fault condition where 2 devices have the same address, is not shown when in this particular mode.

## 7 Monitor Device Counts & Test

### 7-1 Device Count, Type & Value

Use this function to check that all Sub-panels are present and that all devices are present.

Use +/- to select the Analogue Loop number and 0-9 and ▲ ▼ to select the device address on that loop.

This function is also useful to confirm the address of the various different types of devices connected to the Analogue Loops.

Note that in Installation Mode all information is live i.e. the count of devices will change as the panel learns and device types will be updated if they change. In Active Mode only the device value is live.

### 7-2 Test Sounders

Use this function to test the audibility of the sounders in a more comfortable manner than pressing SOUND ALARMS.

#### Main Panel

The Main Panel Conventional Sounders will sound for 1 second then be silenced for 9 seconds.

#### Standard Sub-panels

Conventional Sounders and Loop Sounders are operated for 1 second then silenced for 9 seconds.

#### Integrated Sub-panels

Conventional Sounders and Loop Sounders are operated for 1 second then silenced for 9 seconds.

Conventional Sounder operation for a Repeater Integrated Sub-panel will be synchronized to the Loop Sounder operation.

### 7-3 Sounders on Test Activation

This function allows you to choose an audible confirmation that a device has detected a fire. The audible confirmation consists of a 1 second period of sounder operation. The settings selected by this function are used by '7-4 Test Zones' and '6-4-1 Activate ASET Mode (SAM)'.

ALL SOUNDERS ON DETECTOR TEST activates the Main Panel Conventional Sounders and all Conventional Sounders and Loop Sounders on the Sub-panel under test.

SUB\_PANEL SOUNDERS ON DETECTOR TEST only operates the Conventional Sounders and Loop Sounders on the Sub-panel under test. I.e. The Sub-panel that the detector under test is physically connected to.

**Note** - using this function AFTER '7-4 Test Zones' and '6-4-1 Activate ASET Mode (SAM)' will NOT change the settings for the zones already in test mode and the loops already in ASET mode.

### 7-4 Test Zones

Select the Zones you wish to put into test mode.

Exit programming mode, but DO NOT press SYSTEM RESET as this clears all test modes.

In test mode when a detector is activated the LED on the detector will be illuminated and the event will be reported on the Main Panel (and Repeaters) for 15 seconds. If selected then the sounders will also operate for 1 second. The LED on the detector is not latched and will clear when the alarm level falls below the alarm threshold for the device.

Pressing TEST QUEUE REVIEW will report the zones that are in Test Mode.

### 7-5 Sub-Panel LED Test

This function is used to confirm that all the Standard Sub-panel LEDs are functional.

Each of the LEDs on all sub-panels will operate in sequence.

The test is only performed whilst LED TEST MODE is shown within this programming function. There is no need to press ENTER just use UP/DOWN to toggle between LED NORMAL MODE and LED TEST MODE.

This test has no effect on Integrated Sub-panels.

Upon exit of this programming function normal functionality is automatically restored.

### 7-6 Light LED on device

This function is used to confirm the physical location of a specific detector.

For each Sub-panel only one detector LED can be lit at any one time.

Select the device and SWITCHED ON and press ENTER. The device will typically take a few seconds to respond.

Selecting NORMAL for that device, or selecting SWITCHED ON for another device on the same Sub-panel, will clear the LED on the first device.

## **8 General**

### **8-1 Time/Date & Timers**

#### **8-1-1 Set Date & Time**

Allows the date and time for the system to be set. The date and time is displayed on the LCD whilst the system is not in fault or fire.

Press ENTER to skip an entry and after each entry.

It is important to set the date and time because it is used in the event logging and may also be used to change the detector sensitivities or to disable delays at night.

There is only one clock in the system. Setting the date and time at a Repeater is actually setting the Main Panel clock.

#### **8-1-2 Define Day & Night**

Defines sunrise and sunset for the system.

The system considers a day to start at sunrise. So when different detector sensitivities are set for different days (function 6-1-8) the new day will start at the sunrise time defined here.

If different sensitivities have been set for day and night (function 6-1-9) then the times defined here are the times the sensitivity change will take place.

If delays have been set to be switched off at night (function 8-1-3) then this will happen at the sunset time defined here.

#### **8-1-3 Delays Off at Night**

This function allows the delays for Sounders, I/O activation and Fire Brigade Transmission to be overridden at night.

There are two options: OFF and UNAFFECTED.

UNAFFECTED means that the system settings will remain the same at night as they are during the day.

OFF means that at night time the Sounder, I/O module and Fire Brigade Transmission delays are all turned off and the outputs will activate immediately a fire is detected.

This function has exactly the same effect as using the ACTIVE DELAYS button on the front panel to disable the delays at sunset, then using the same button to restore the day setting at sunrise.

Sunrise and sunset are defined using function 8-1-2.

### 8-1-4 Configure Evacuate Timer

Allows the evacuate timer to be enabled and the duration of the timer to be set.

The evacuate timer runs in parallel to all other events. Once triggered it starts counting down, when it expires all sounders are activated. This means various sounder groups may be activated in the meantime (and even silenced) but when the evacuate timer expires all sounders not sounding are activated.

10 minutes is the maximum duration.

The Evacuate Timer can be set to:

DISABLED  
DEVICE MODE  
GLOBAL MODE

In DEVICE MODE the evacuate timer is started when a device that has been configured to start the Evacuate Timer detects a fire.

In GLOBAL MODE the Evacuate Timer is started when any device detects a fire.

**Note -** for DEVICE MODE to work at least one device must be set to start the timer. See programming function 8-1-5.

**Note -** once started the evacuate timer is not stopped by pressing ALARM SILENCE, although ALARM SILENCE will still silence the sounders once they have been activated.

**Note -** disabled sounders are never activated by the evacuate timer.

### 8-1-5 Device Starts Evacuate Timer

Allows you to specify specific detectors that will start the Evacuate Timer.

The Evacuate Timer must be in DEVICE MODE to be activated by specific devices. See programming function 8-1-4.

### 8-1-6 Fire Brigade Delay Set-up

Allows the Fire Brigade Delay timer to be enabled and the duration of the delay to be set.

10 minutes is the maximum duration.

The timer can be set to:

DISABLED  
ZONAL MODE  
GLOBAL MODE

The triggering of the delay must also be specified, settings are:

CALL-POINTS ONLY - call-point start the delay, other devices cause immediate fire brigade output activation.

DETECTORS ONLY - any device that isn't a call-point starts the delay, call-points will cause immediate fire brigade output activation.

ANY DEVICE - any device will start the delay.

If the function is set to ZONAL MODE it is also necessary to set up the activation using Function 3-6 Zone Fire Brigade Delay Set-up.

For the Fire Brigade delay to operate the front panel ACTIVE DELAYS button has to be set to on.

**Note** - specific devices (function 6-1-6) can be set to override this delay.



## **8-2 Special Features Set-up**

Programming functions associated with the system response and detection of a fire.

### **8-2-1 Two Devices to Evacuate**

Enables or disables a system wide setting that detection of fire by two detectors automatically starts evacuation.

Evacuation means any Sounder Group settings will be ignored and all sounders will be operated immediately.

**Note -** disabled sounders will not be activated.

### **8-2-2 Call Points to Evacuate**

Enables or disables a system wide setting that a report of fire from a call-point automatically starts evacuation.

Evacuation means any Sounder Group settings will be ignored and all sounders will be operated immediately.

**Note -** disabled sounders will not be activated.

## **8-3 Memory - BEWARE, ENGINEERS ONLY**

Programming functions that are associated with management of the Main Panel memory.

### **8-3-1 Clear Customer Flash Memory**

This function erases all of the site specific data from the customer Flash memory on the SIM CARD. This is the majority of the programmed settings.

DO NOT erase this data if you were supplied with pre-programmed site data.

It is not recommended that this function is carried out from a Repeater as the erase will take a few seconds and during that time communication to the Repeater will be lost.

If the Customer Flash Memory is cleared:

- All Sounder Groups will have continuous sounder operation
- All Sounder Group definitions will be cleared
- The Sounder Configuration will be set to PRESET
- All Zone text will be cleared
- All Zone Sounder and I/O group settings will be cleared
- All Zone definitions will be cleared (no devices assigned)
- Zone sounder delay settings will be cleared
- The company name will be cleared
- All device text will be cleared
- All device specific settings will be cleared
- All sensitivity settings will be reset
- All delay settings will be cleared
- The language will be reset to English
- All I/O group definitions will be cleared
- User access to all programming functions will be denied

**Note** - the Installer Access Code will not be cleared.

After clearing the Customer Flash Memory it is essential to perform a system Master Reset to ensure the new settings are sent to all sub-panels. (Settings are otherwise only sent when they are changed using the programming functions.)

### 8-3-2 Clear Non-Volatile RAM

Clearing the NVRAM on a panel with an Integrated Sub-panel will also clear the NVRAM for the Integrated Sub-panel. Because clearing the NVRAM clears all the installation settings the system is automatically put into Installation Mode.

For the Sub-panel this means:

- Information on all fitted devices will be cleared
- Checksums will be cleared, and re-calculated
- Sensitivity settings will be cleared

For the Main Panel this will result in:

- All disabled Analogue Loops will be enabled
- All disabled Zones will be enabled
- All disabled devices will be enabled
- The printer will be enabled
- All disabled sounders will be enabled
- The event log will be cleared
- The auto-reset count will be cleared
- Information on fitted sub-panels will be cleared
- All checksums will be cleared and recalculated
- If system is in Active mode it will revert to Installation mode.

After clearing the NVRAM it is essential to perform a system Master Reset to ensure the new settings are sent to all sub-panels. (Settings are otherwise only sent when they are changed using the programming functions.)

### 8-3-3 Calculate Customer Flash Checksum

Calculates and stores the checksum for all the data in the customer Flash memory.

When settings are changed using the programming functions this checksum will be re-calculated as required. Downloads of customer data also result in an automatic update of the checksum. However if a SIM CARD is supplied with pre-programmed data (i.e the data changed externally) this function is necessary otherwise the panel will believe the data has been corrupted and report a fault.

This stored checksum is regularly (approximately every 2 minutes) compared with a freshly calculated checksum to check for memory corruption.

### 8-3-4 Calculate Program Flash Checksum

Unlikely to be required in normal circumstances, this function calculates and stores a checksum for the program Flash memory.

Software upgrades, either downloaded, or from a new SIM CARD are detected by the Main Panel and automatically result in a new checksum being calculated and stored.

This stored checksum is regularly (approximately every minute) compared with a freshly calculated

## 8-4 Other Features

These are programming functions that do not fall into any other category.

### 8-4-1 Active/Installation Mode

An essential function. The system should always be left in ACTIVE mode, unless the system is being installed and debugged.

When the system is set to Installation Mode the green SYSTEM ON LED on the front panel of the Main Panel and Repeaters will flash.

Whilst in Installation Mode the system will automatically detect and record the presence of all connected devices and sub-panels.

To install the system first ensure all detectors, sounders and sub-panels are connected and have power. Next select Installation Mode using this function, exit programming mode and press SYSTEM RESET.

Once the system has been in Installation Mode for 90 seconds then the system can be put into Active Mode.

Note that there is no clear end to Installation mode because the system is constantly looking and learning. However if the system is put into Active Mode and Installation Mode hasn't had time to identify all system components you will very quickly be greeted with error reports regarding the presence of unexpected devices.

If devices are ever removed, replaced or added then Installation Mode must be selected so that the system can learn the new configuration. If you do not do this the system will report a fault.

### 8-4-2 Upload/Download Link to PC

This function cannot be accessed remotely (from a Repeater or from the PC Graphics software). Entering this function will automatically stop all normal fire alarm system operations including communications to sub-panels and Repeaters.

- It allows customer site data to be downloaded into the Customer Flash Memory.
- It allows customer site data to be uploaded from the Main Panel to a PC. You may wish to do this to save the configuration or for ease of editing. Once edited the data must be downloaded back into the panel.

To perform an upload or download you will need the correct hardware fitted to the Main Panel, a lead for connection to a PC and the correct PC software.

Connection to a PC requires a pin-pin 9 way lead with a male D connectors at one end and a female D connector at the other end. (Only three wires are actually necessary, so if problems are encountered it is worth trying a lead with only three wires - Tx (pin 2), Rx (pin 3) and GND (pin5)).

The PC Loader Software

The PC Loader software is runs under Windows® (98, 98SE, Me, 2000 and XP). Communications to the panel is through one of the serial communication ports (COMM PORT) and in order to install it, the only requirement is to double click on the installer package supplied and follow the supplied instructions.

Windows® COMM PORT Set-up

**Please consult our other document entitled "LOADER SOFTWARE" for more detailed instructions.**

The Main Panel

Before entering the UPLOAD/DOWNLOAD Function, The RS-485 and Fibre Optics data Loop connections to Sub-panels and Repeaters on the J-NET-CON board should be removed (CON 5). This task should always be carried out with no power applied to the system. Also, RS-485 and Fibre Optics Interface boards mounted on this board should be removed.

Connect the RS232 cable from the PC to the 9 pin plug mounted on the J-NET-CON board of the main panel. Upon completion of this, re-apply power to the system.

Put panel in INSTALLATION mode using Function 8-4-1 to prevent the appearance of FAULT conditions due to the absence of Data Loop communications.

Entering the UPLOAD/DOWNLOAD LINK TO PC Function 8-4-2 will immediately stop all normal communication to Sub-panels and repeaters connected to the Data Loop.

The panel's LCD display should show the following:



When ready, press ENTER on the panel to Start upload/download on panel and then start upload/download on PC.

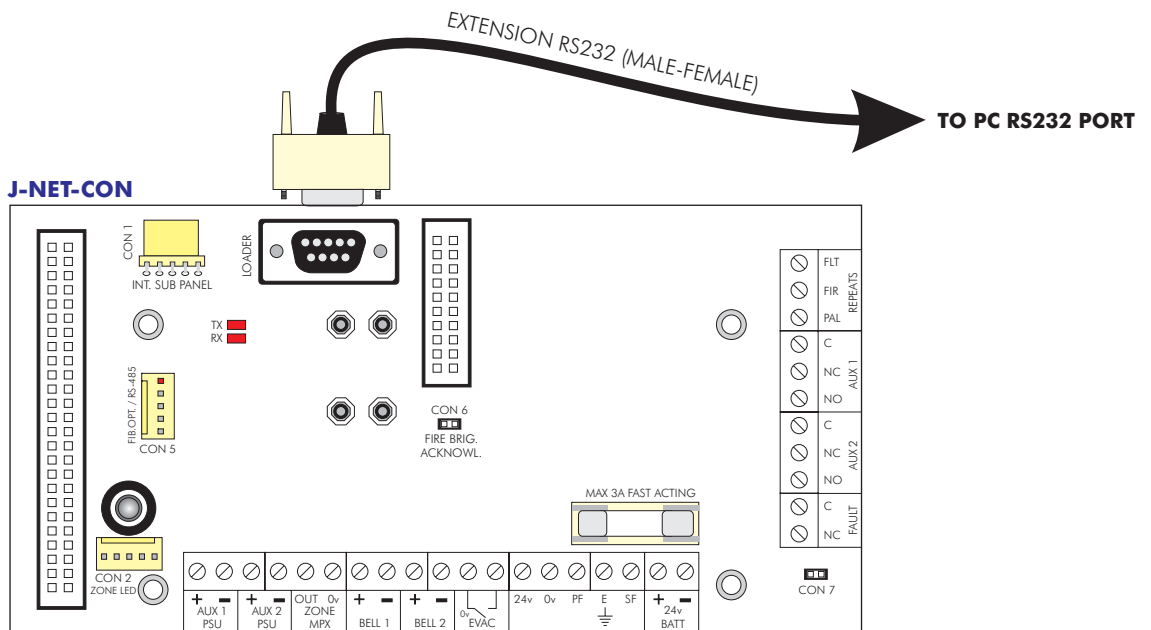

### Uploading/Downloading Customer Site Data

Depending on the amount of data transferred an Upload or Download can take up to 6 minutes.

It is not necessary to enter Installation Mode after uploading or downloading Customer data. But a Main Panel Master Reset is essential (and will happen automatically when the Main Panel is powered up after the original PCBs are re-fitted).

### 8-4-3 Printer Disable/Enable

Use this function to disable the printer operation (if the printer is fitted).

### 8-4-4 Set User Access Code

Use this function to set the User Access Code. This access code only permits access to the functions defined by 8-4-5 Set User Functions.

The code consists of 5 digits.

Don't forget to tell the user the new number!

### 8-4-5 Set User Functions

Allows the user access level to be set for every programming function.

Settings are:

NONE  
READ ONLY  
FULL ACCESS

Do not set 8-4-5 Set User Functions to FULL ACCESS or the user will be able to enable all the other functions!

It is not appropriate to set some functions to READ ONLY - for example "8-3-4 Calculate Program Flash Checksum".

The default setting for all programming functions is NONE.

### 8-4-6 Select language

Allows the language setting to for the system to be set.

Do this carefully - you will need to navigate back to this function to change it back again.

All text in the system will be changed to use the selected language. The change will take effect when ENTER is pressed.

Languages supported are:

BRAZILIAN  
ENGLISH  
FRENCH  
HUNGARIAN  
ICELANDIC  
ITALIAN  
PORTUGUESE  
SPANISH

8-4-7 - REMOVED - Function no longer available

8-4-8 Set Installer Access Code

This function allows changing the Installer Code without requiring knowledge of the Factory Code.

Display will show:

ENTER PRESENT CODE  
ENTER NEW CODE  
CONFIRM NEW CODE



## 8-5 Remote Access and Monitoring

Remote access and monitoring can be performed via RS485, RS232 or a modem (RS232).

Remote access and monitoring via RS485 and RS232 is performed using the Odyssey PC software whilst the Telemon PC software is used in conjunction with a modem. The term PC Graphics Software is used to describe the Odyssey or Telemon software.

The QUART (optional) is essential for the operation of remote monitoring. If the QUART is not fitted the panel will deny access to functions 8-5-1, 8-5-2 and 8-5-3.

The remote access connection is made to the 9 pin D connector on J-NET-INT-COMS which is plugged into the J-NET-CON on the Main Panel. There are a few types of J-NET-INT-COMS boards but the same variant can be used for direct RS232 Odyssey connection or connection to a modem.

The JUNO-NET is compatible with most RS232 modems. Modem communication is at 9600 baud, 8 bits, 1 stop bit with no parity.

A modem is usually connected to a PC with a "null modem" cable. For connection to JUNO-NET a "straight through" or "pin to pin" lead is required. This lead needs to be fully wired.

When the system is powered up, or a Master Reset is performed, the Main Panel looks for modem on the remote access port. If one is found it will automatically be used for all remote monitoring.

### 8-5-1 Configure PC Graphics Software Interface

The PC Graphics Software considers a complete fire alarm system (Main Panel, Repeaters and Sub-panels) as a single (Main) panel.

Each fire alarm system must be given a unique number between 1 and 64. This function allows you to set that 'panel' number.

If a panel number is not set the PC Graphics Software may not be able to monitor and access the fire alarm system.

### 8-5-2 Modem Dial Out Number

This function allows the telephone number of the remote monitoring PC to be entered. The panel will use this number to dial out if a Fire, Fault or Pre-alarm is detected.

If a number is not entered the panel will not dial out, but a remote PC may still dial in.

The telephone number may be a maximum of 30 characters long and may include any characters that the modem recognizes. Spaces may be used to make the number more readable. Other characters that are often used are shown on the next page.

- P Use pulse dialing
- T Use tone dialing.
- @ Wait for silence for 5 seconds before dialing
- , Pause for 2 seconds

For example:

T9,,44,117 123 456

### How The Dial Out Works

- From dialing the panel allows 60 seconds for connection to the PC Graphics Software or the attempt fails.
- If the line is engaged or the dial out fails the panel will perform 30 re-dial attempts 1 minute apart, every 10 attempts the modem will be reset.
- If the PC Graphics Software link is idle for 3 minutes the modem disconnects and hangs up.
- If the PC Graphics Software hangs up the telephone line at its end the JUNO-NET will hang up within 60 seconds.
- A JUNO-NET front panel SYSTEM RESET or a remote reset from the PC Graphics Software will not immediately drop the modem link.
- After a panel reset, either from the front panel or remotely from the PC Graphics Software, the panel needs to see PC Graphics Software communications within 30 seconds or the modem will disconnect.
- A Master Reset or power cycle of the Main Panel will always cause a modem disconnect.
- After 30 consecutive failed dial out attempts the modem will be considered inoperable and no further dial out attempts will be made. However, a successful incoming call will reset this count.
- Even when the panel thinks the modem is inoperable it will allow the modem to receive incoming calls (if it can). A successful incoming call will reset all modem error flags and counts.
- If any errors are encountered whilst communicating with the modem the modem is reset.

### 8-5-3 Modem Initialization String

This function should not normally be required. It allows an additional initialization string to be entered for the modem.

This function may be required to support certain modems or telephone systems.

This string can be a maximum of 30 characters long.

Please note that these specifications apply to the stand-alone Juno Net Analogue Addressable panel, 1 or 3 loops models, equipped with a 2.4 Amp power supply.

<b>Weight:</b>	Empty: 5.1 Kg Including sealed lead acid batteries: 2 x 12 V 7 AH 10.5 Kg 2 x 12 V 12 AH 13.5 Kg
<b>Operating temperature:</b>	0°C to + 40°C
<b>Relative Humidity:</b>	85% (non-condensing)
<b>Conventional Sounder Circuits:</b>	2 individually programmed. Both circuits current limited and monitored for both open and short circuit fault conditions. 10k Ohm E.O.L. resistors are used. Maximum current rating/sounder circuit 400mA.
<b>Auxiliary Relay Outputs:</b>	2 voltage free changeover relay outputs used for fire indication. 1 voltage free relay output for fault indication. Remains energised (normally closed) under normal condition and de-energises when any fault condition appears on the system. Maximum current rating for each relay contact 1A @ 50 V AC/DC resistive.
<b>Sensor / Loop Circuits:</b>	1 loop or 3 loop models. Supports analogue addressable devices over a 2 wire combined power and digital data transmission loop. Maximum single loop current loading is 275 mA. Maximum total current load for 3 loops is 825mA. Maximum recommended loop length is 1 Km with 1.5 mm <sup>2</sup> wire cross-section. Maximum cable capacitance 120 pF/m. Minimum cable cross-section: 0.5 mm <sup>2</sup> Maximum cable cross-section: 2.5 mm <sup>2</sup>

### **Power Supply and Charger**

<b>Primary Supply:</b>	85-264 V AC.
<b>Input Operating Voltage:</b>	3 Amp - Surge protected (slow blow). 4 Amp - Fast Action 20 mm HRC Fuse located on electrical mains connector TB, placed on top of the aluminum PSU cover.
<b>Maximum Continuous Primary Power Supply Rating:</b>	2.4 Amps @ 28 V DC nominal, comprising: 1 Amp max. temperature compensated, short circuit protected, battery charger. 1.4 Amp used for internal electronic circuits and external ancillary circuits: A maximum of 825 mA is available for loop power (275 mA/loop). Maximum of 100 mA for internal electronic circuits. 460 mA for auxiliary power supply output. Under alarm conditions a maximum of 1 Amp current available for conventional sounder circuits.

**Power Budget Quiescent Condition:**

- a - 100 mA internal circuits
- b - 460 mA auxiliary supply outputs
- c - 825 mA for analogue loop power
- d - 1 Amp for battery charger.

800 mA for conventional sounder circuits +a+b+c

**Alarm Condition:**

Maximum 27.5 V DC

**DC Output Voltage:**

Minimum 18.9 V DC

**Max. Ripple Voltage:**

400mV peak-to-peak @maximum output loading.

**Battery Charger Output:**

27.5 V DC nominal @ 20°C

**Secondary Supply:**

- 24 V sealed lead acid batteries.
- Minimum capacity 2 x 7 AH
- Maximum capacity 2 x 12 AH
- Both fitted internally.
- Battery Fuse 3 A - 20 mm HRC

**Repeater**

Primary supply voltage  
EMC Standard

- 85 - 264 VAC
- EN55022 class B
- EN61000-4-2,3,4,5,6,8,11
- EN61000-3-2,3

Secondary supply voltage

24V DC nominal

Power supply rating

65W or 150W

Quiescent current (without devices)

130mA

Auxiliary relay ratings

50V AC/DC 1 Amp Resistive

Repeater outputs

Open collector 24V DC 100mA max

Dimensions

W 340mm x H 370mm x D 125mm

IR Keypad batteries

2 x AAA

Fuses

Battery: 3A

**Standard Sub-panel**

Primary supply voltage  
EMC Standard

- 85 - 264 VAC
- EN55022 class B
- EN61000-4-2,3,4,5,6,8,11
- EN61000-3-2,3

Secondary supply voltage

24V DC nominal

Power supply rating

65W or 150W

Quiescent current (without devices)

80mA

Dimensions 1-9 loops

W 340mm x H 370mm x D 125mm

## CE DECLARATION OF CONFORMITY

GFE Lda, manufacturer of addressable fire detection equipment, declares, that the **JUNO-NET** fire control panel and repeater panels conform to the following directives of the EEC commission:

**Construction Products Directive 89/106/EEC amendment 93/68/EEC  
73/23/EEC - Low Voltage directive and amendment 93/68/EEC  
89/336/EEC - EMC Directive and amendments 92/31/EEC & 93/68/EEC**

and comply with the following standards:

**EN55022 class B, EN61000-4-22,3,4,5,6,8,11  
EN61000-3-2,3 EN54 Pt 2 and Pt 4.**

We, Global Fire Equipment Lda. hereby declare, for the effects of the requirements laid down with EN-54 Pt4 **paragraph 6.1**, that the power supply equipment included in our analogue addressable fire alarm panel named JUNO-NET, has been designed in accordance with a quality management system which incorporates a set of rules for the design of all elements of the p.s.e., and that its components have been selected for the intended purpose, and expected to operate within their specification when the environmental conditions outside the cabinet comply with class 3k5 of IEC 721-3-3 : 1978

We, Global Fire Equipment Lda. hereby declare, for the effects of the requirements laid down with EN-54 Pt2 **paragraph 12.1**, that the control and indicating equipment which is our analogue addressable fire alarm panel named JUNO-NET, has been designed in accordance with a quality management system which incorporates a set of rules for the design of all elements of the c.i.e. and its components have been selected for the intended purpose, and are expected to operate within their specification when the environmental conditions outside its cabinet comply with class 3k5 of IEC 721-3-3 : 1978

We, Global Fire Equipment Lda. hereby declare, for the effects of the requirements laid down with EN-54 Pt4 **paragraph 6.3.2**, that the power supply equipment included in our analogue addressable fire alarm panel named JUNO-NET, is in accordance with IEC 950:1991 for protections against direct and indirect contact, for the separation of the extra low voltage DC circuits from the low voltage AC circuits and for earthing of metal parts.

  
João Paulo Galvão  
Managing director

This panel is  marked to show that it conforms to the requirements of the above European Community Directives:

It is assumed that the user of this manual is a suitably-trained operator/maintainer

**WARNING**

**THIS PANEL CONTAINS S (LIVE) VOLTAGE. ALWAYS DISCONNECT THE MAINS SUPPLY FROM THE PANEL BEFORE REMOVING OR INSTALLING COMPONENTS.**



**ELECTRO-STATIC SENSITIVE DEVICES (ESD) TAKE SUITABLE ESD PRECAUTION WHEN REMOVING OR INSTALLING PRINTED CIRCUIT BOARDS.**

**GLOBAL**  
FIRE EQUIPMENT

Urb. Vale da Amoreira, Lote 16 & 17, Porta A, Cave, 8005-334, Faro, PORTUGAL

TEL.: (00351) 289 896 560 FAX.: (00351) 289 865 587 e-mail: [global@globalfire.pt](mailto:global@globalfire.pt) website: [www.globalfire.pt](http://www.globalfire.pt)