

CATALOGUE
2007.2008

Videointercoms
Telecommunication
Access Control

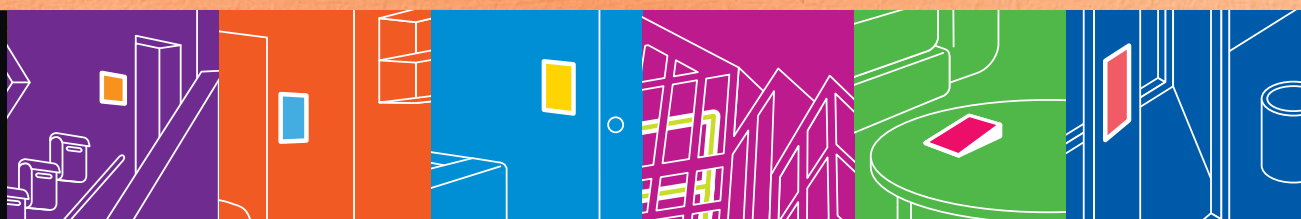

2007.2008



The Best Way
to Communicate



ACI FARFISA
INTERCOMMS

technology in evolution



ACI Farfisa

In 1967 Farfisa starts as division under the same name of the famous company that operates in the electronic musical instrument field. In 1993 Aci Farfisa is established as an independent Company and after few years successfully stands out on the main markets world wide in videointercom, telecommunication and CCTV field. This last sector is fully described in the specific Videosurveillance Catalogue.

Aci Farfisa, thanks to a strong enterprise tradition and with the continuous investments in research and specialised personnel, meets today the various requirements in Italy and sixty export countries with high competitive and quality-guaranteed products. The deep distribution network and technical assistance fulfil the high company profile, that satisfies the requirements of the single markets.

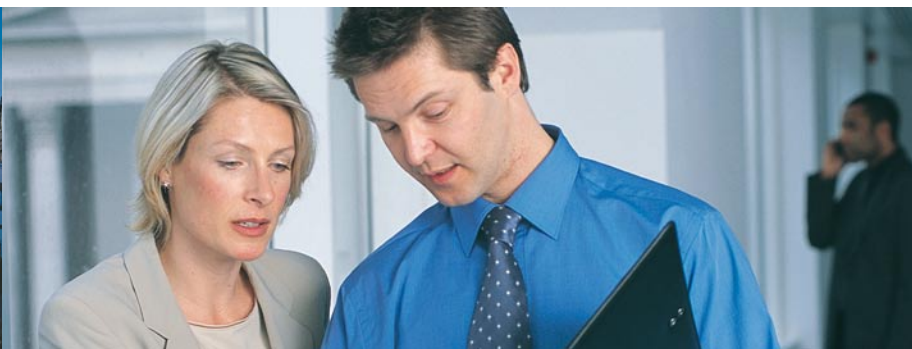

A global market

Since its foundation Aci Farfisa offers with growing success its products and services in Italy and exporting them in more than 60 countries all over the world.

Aci Farfisa is a secure and reliable partner caring any element of the commercial relationship and distribution chain. A strategical vision always oriented to satisfy the client.

- Aci Farfisa conceives and designs its own products, selects the material and this allows to offer a complete and versatile items range. All the new range are coming from deep analysis and taking in right consideration the most exigent market demands.
- The punctual evaluation of the technical and technological evolutions allows to fulfil at the best the needs of the Electrical Installation and Electronic Security World.
- The continuous and punctual communication with the Sales network about new products and activities, joint to the several Assistance Centres, capillary located on the territory, professionally guarantees the After Sale Service with the best competence.

Quality

Aci Farfisa has been granted the ISO 9001:2000 certification for its Corporate Quality System to guarantee the efficient working standards used and the strict control on the production cycle; this step confirms that one already reached in 1998 with Company Quality System certification.

Aci Farfisa provides solutions in compliance with the European regulations on Electromagnetic Compatibility and Safety in force. In particular, power supplies comply with all safety specifications of the European standard.

ACI Farfisa
is member of:





DUO system

Setting new standards

The easy system that reduces times and costs



-  practical
-  easy
-  low cost

Duo System is the most innovative philosophy of Aci Farfisa digital system, for a practical and fast videointercom installation, that allows to cut strongly time and costs and avoids eventual wiring errors. A new technology that simplifies the videointercom systems of medium size and that evolves with technological updating; with Duo System only 2 non-polarised wires are enough to make easily even complex installations. Thanks to updating and new implementations of the system, it is possible to increase the number of users and distances.

DOOR STATIONS



INTERNAL STATIONS



As a matter of fact today new apparatus planned for Duo System allow to reach **200 internal stations**, up to 8 main video external door stations and 3 secondary for every riser! Video and audio signals, opening door lock service and controls of various functions stay only on 2 non-polarised wires, simplifying the system and improving the quality. The wiring is easier, the time of carrying out is shorter, for a great decreasing in installation costs.

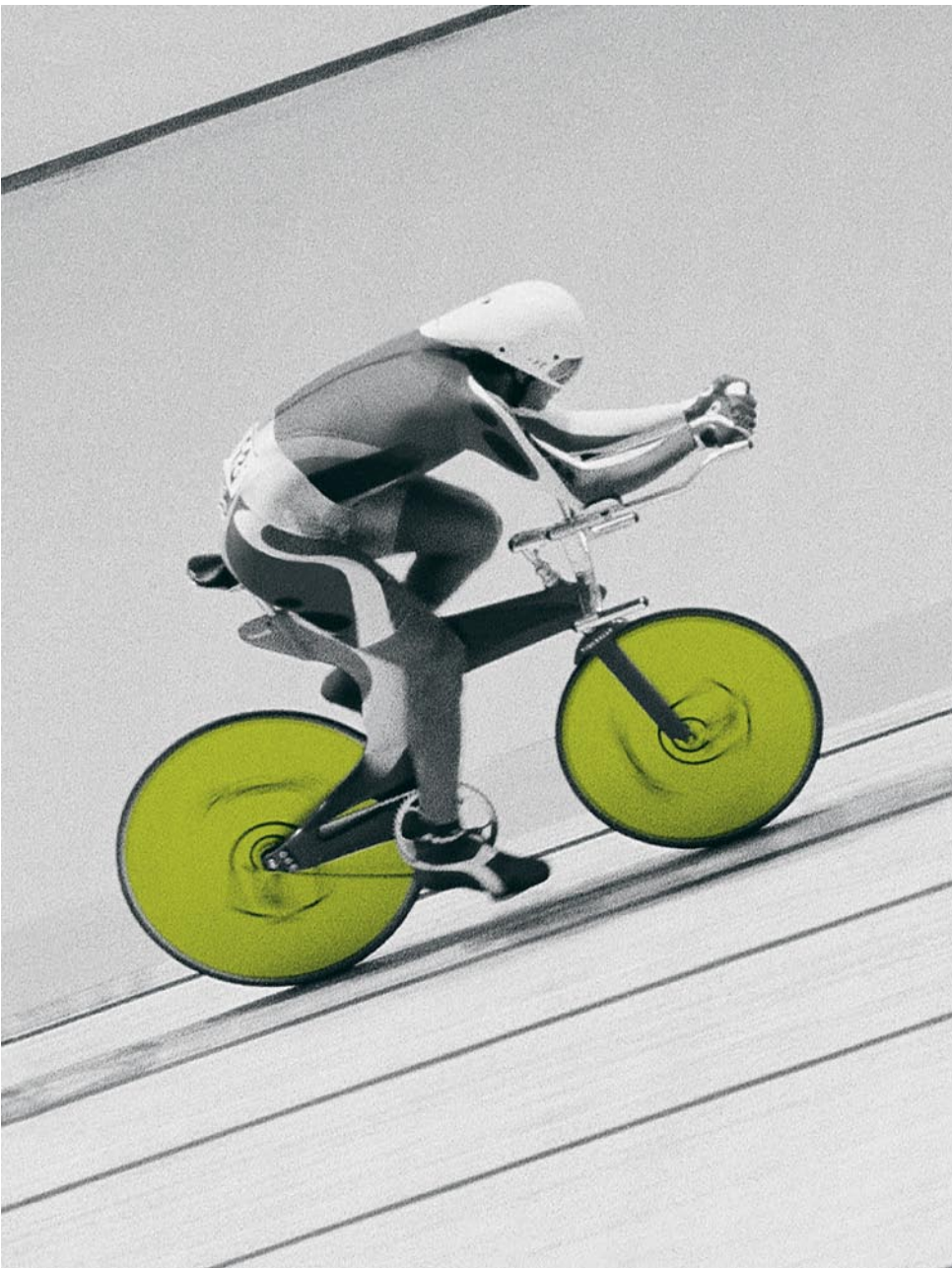

Echos



Colour communication



The new ACI FARFISA videointercom range ECHOS provides the most requested features presently, thanks to its elegant and fashionable structure. It is perfectly suitable with the new trends for architecture; as a matter of fact, ECHOS is conceived colour version, with 3.5" LCD screen, adjustable on horizontal axis for all the different requirements in case of light reflex and for the various user's tallness. Moreover, this monitor is hand-free, therefore once pressed the speech activation button, communication without the traditional handset is possible. It is supplied with buttons for door lock release, display turn-on, chime exclusion (with LED for setting indication), audio volume and picture brightness adjustment, intercommunication and additional services. ECHOS is perfectly suitable to PROFILO and MATRIX external door stations. Also one-way videokits are already available.

Index

Door stations



- 10** Profilo
- 12** Profilo compositions
- 14** Matrix
- 16** Matrix compositions
- 18** Mody
- 20** Mody compositions
- 22** Erre P/R
- 23** UP
- 24** TM
- 25** Prestige

Videointercoms

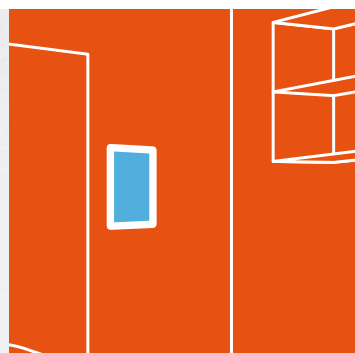

- 28** Col. electr. call/Echos
- 30** Col. electr. call/Compact
- 31** Col. electr. call/Studio
- 32** B/W. electr. call/Compact
- 33** B/W. electr. call/Studio
- 34** Col. electr. call/Compact 4+1
- 36** B/W. electr. call/Project 4+1
- 37** Col. altern. call/Project
- 39** Service modules
- 40** Videointercom Kits

Intercoms

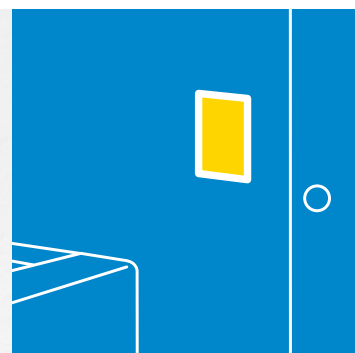

- 44** Electronic call/Compact
- 45** Electronic call/Studio
- 46** Electronic call/Project
- 48** Alternate call/724N - 924W
- 49** Electronic call/Compact 1+1
- 50** Electronic call/Project 1+1
- 51** Power supplies and service modules
- 52** Intercom kits
- 54** Kit composition
- 55** Interphone

Digital Systems



- 58 **DUO System**
- 58 DUO/Matrix
- 60 DUO/Compact
- 61 DUO/Project
- 62 **FN4000**
- 63 FN4000/Matrix
- 64 FN4000/Mody
- 65 FN4000/Compact
- 66 FN4000/Project
- 67 FN4000/Studio
- 68 FN4000/System Composition
- 69 **DF6000**
- 70 DF6000/Mody
- 71 DF6000/Project

Telecommunication



- 74 Integrated communication
- 76 Video-Intercom telephone set

Access Control

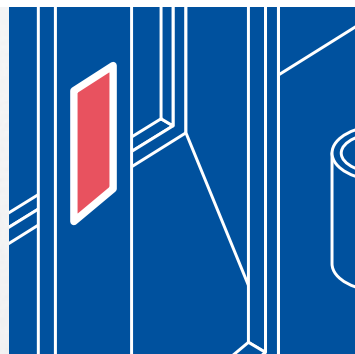

- 80 Proximity Readers
- 81 Keypads

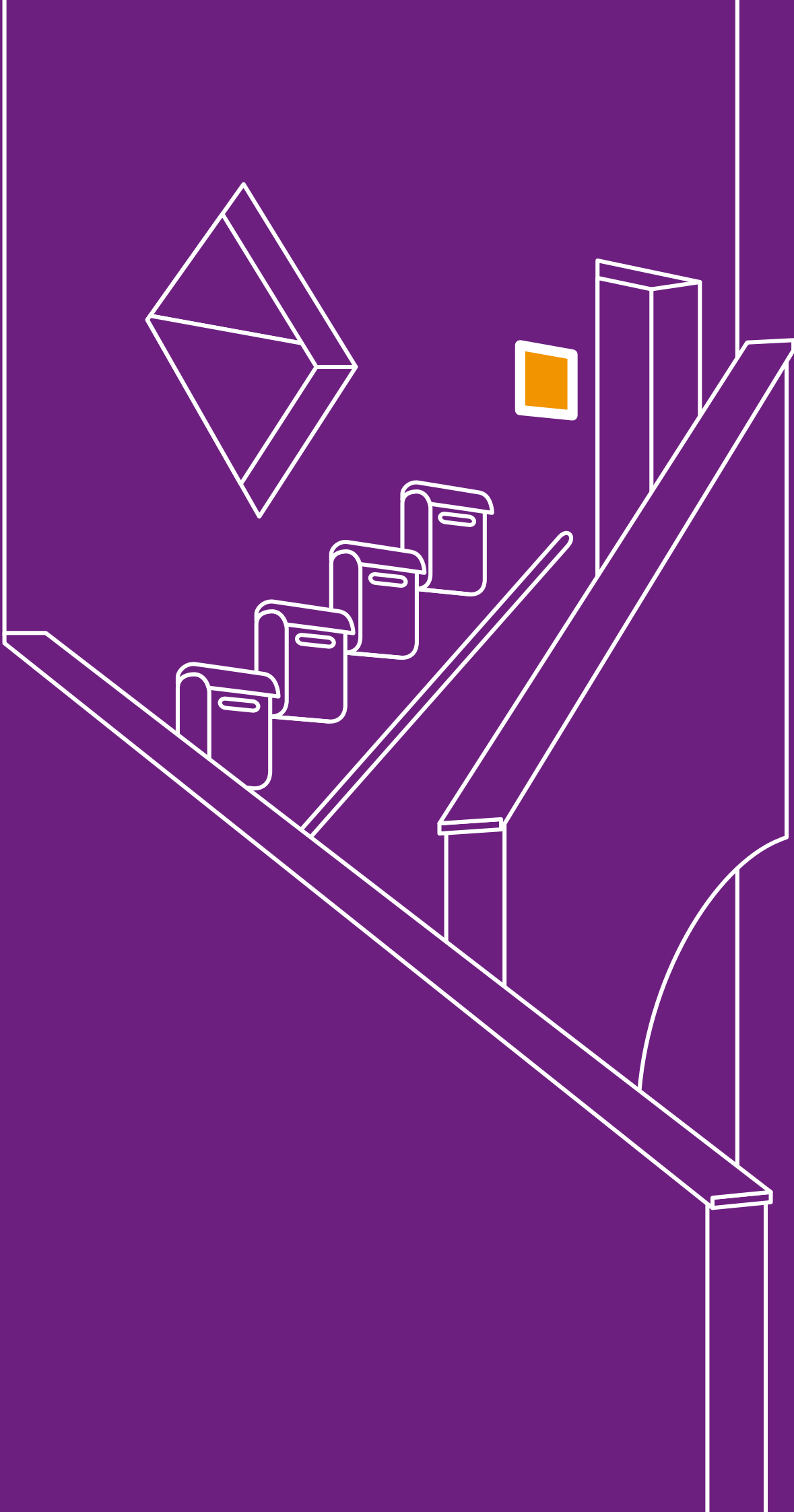

Door stations

Profilo	10
Profilo compositions	12
Matrix	14
Matrix compositions	16
Mody	18
Mody compositions	20
Erre P/R	22
UP	23
TM	24
Prestige	25

Profilo series is a further and the most recent range enlargements. It's a modular and compact line, specifically conceived for installations – even complex ones – also where reduced space is available. Matrix antivandal series, elegant and solid is matching a variety of system technologies and – thanks to the modularity – allows also mounting configurations in horizontal way. Versatile, modular and modern solutions are guaranteed by Mody and ErreP/R series. Prestige range – with a quite renewed design – is now even more elegant, so that high class and harmony are guaranteed. Farfisa offers easy-to-install and fine design solutions, conceived to satisfy the most exigent installation requests.





**VIDEOINTERCOM
MODULE FOR 2 CALLS**



**DUBLE ROW BUTTONS
MODULE FOR 4 CALLS**



**INTERCOM
COMPOSITION**

CAMERA MODULES

with door speaker integrated with coax cable



PL40P

Without call buttons

camera | black/white / fixed 3.6 mm lens

w x h x d | 99 x 110 x 17



PL41P

With 1 call button

camera | black/white / fixed 3.6 mm lens

w x h x d | 99 x 110 x 17



PL42P

With 2 call buttons

camera | black/white / fixed 3.6 mm lens

w x h x d | 99 x 110 x 17



PL40PC

Without call buttons

camera | colour/fixed 3.6 mm lens

w x h x d | 99 x 110 x 17



PL41PC

With 1 call button

camera | colour/fixed 3.6 mm lens

w x h x d | 99 x 110 x 17



PL42PC

With 2 call buttons

camera | colour/fixed 3.6 mm lens

w x h x d | 99 x 110 x 17

CAMERA MODULES

with door speaker integrated with coax cable on double row buttons



PL422P

Video module 2 rows buttons with 2 call buttons

camera | b/w fixed 3.6 mm lens

w x h x d | 99 x 110 x 17



PL424P

Video module 2 rows buttons with 4 call buttons

camera | colour fixed 3.6 mm lens

w x h x d | 99 x 110 x 17



PL422PC

Video module 2 rows buttons with 2 call buttons

camera | colour fixed 3.6 mm lens

w x h x d | 99 x 110 x 17



PL424PC

Video module 2 rows buttons with 4 call buttons

camera | colour fixed 3.6 mm lens

w x h x d | 99 x 110 x 17

Profilo

Profilo range of modular door stations – extremely reliable with modern design – allows intercom or videointercom compositions, even complex ones. Front plates are made in aluminium and call buttons in stainless steel, while name-holders are backlit in green colour. Thanks to a great size optimisation of the single module, they are particularly suitable for all the systems in small spaces, for example on automatic gates pillar. The range is composed by audio or video modules with one- or two-row of push buttons, modules with camera with integrated door speaker, back boxes and accessories that allow the possibility of a great users number.

COLOUR 4+1 CAMERA MODULES

with door speaker integrated, reduced wiring on single row buttons



PL40PCED

Video module without call buttons

camera | colour fixed 3,6 mm lens

w x h x d | 99 x 110 x 17



PL41PCED

Video module 1 row with 1 call button

camera | colour fixed 3,6 mm lens

w x h x d | 99 x 110 x 17



PL42PCED

Video module 1 row with 2 call buttons

camera | colour fixed 3,6 mm lens

w x h x d | 99 x 110 x 17

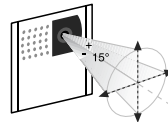

All Profilo video modules have camera with adjustable lens with 6 LED's and autoiris

AUDIO MODULES

with door speaker integrated, for 4+1 intercom systems, alternate or electronic call, single row buttons.



PL10P

Audio module without call buttons

w x h x d | 99 x 110 x 17



PL11P

Audio module with 1 call button

w x h x d | 99 x 110 x 17



PL12P

Audio module with 2 call buttons

w x h x d | 99 x 110 x 17

AUDIO MODULES 4+1

with door speaker integrated, reduced wiring on double row buttons



PL122P

Audio module with 2 rows with 2 call buttons
w x h x d | 99 x 110 x 17



PL124P

Audio module with 2 rows with 4 call buttons
w x h x d | 99 x 110 x 17

AUDIO MODULES 1+1

with door speaker integrated, reduced wiring on single row buttons



PL10PED

Audio module without call buttons
w x h x d | 99 x 110 x 17



PL11PED

Audio module 1 row with 1 call buttons
w x h x d | 99 x 110 x 17



PL12PED

Audio module 1 row with 2 call buttons
w x h x d | 99 x 110 x 17

241DMA

4-diode module to be inserted in button modules PL21, PL22, PL23, PL24 for audio 1+1 and video 4+1 systems.

ADDITIONAL BUTTON MODULES



PL21

With 1 call button
w x h x d | 99 x 110 x 17



PL22

With 2 call buttons
w x h x d | 99 x 110 x 17



PL23

With 3 call buttons
w x h x d | 99 x 110 x 17



PL24

With 4 call buttons
w x h x d | 99 x 110 x 17



PL226

2 rows with 6 call buttons
w x h x d | 99 x 110 x 17



PL228

2 rows with 8 call buttons
w x h x d | 99 x 110 x 17

OTHER MODULES



PL20

blank module
w x h x d | 99 x 110 x 17



PL50

Street number module
w x h x d | 99 x 110 x 17

Built-in back boxes and rain shelters are studied for Profilo modules to be respectively surface or flush mounted. They include the module frames for the precise and exact insert of the corresponding door station modules. They can be combined in order to get an installation of a great number of users. For further protection hood covers can be added to back boxes.

BUILT-IN BACK BOXES

PL71

back box for 1 module
w x h x d | 133 x 91 x 47

PL72

back box for 2 modules
w x h x d | 244,5 x 91 x 47

PL73

back box for 3 modules
w x h x d | 356 x 91 x 47

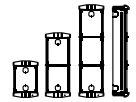

HOOD COVERS

PL81

For 1 module
w x h x d | 118 x 41 x 153

PL82

For 2 modules
w x h x d | 118 x 41 x 264

PL83

For 3 modules
w x h x d | 118 x 41 x 376

PL84

For 4 modules on 2 vertical rows
w x h x d | 41 x 217 x 264

PL86

For 6 modules on 2 vertical rows
w x h x d | 41 X 217 X 376

PL89

For 9 modules on 3 vertical rows
w x h x d | 41 x 316 x 376

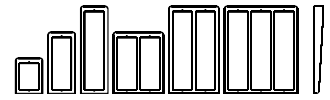

RAIN-SHELTERS

PL91

Rain shelter for 1 module
w x h x d | 118 x 80 x 154

PL92

Rain shelter for 2 modules
w x h x d | 118 x 80 x 265

PL93

Rain shelter for 3 modules
w x h x d | 118 X 80 X 377

PL94

For 4 modules on 2 vertical rows
w x h x d | 41x217x264

PL96

For 6 modules on 2 vertical rows
w x h x d | 41 X 217 X 376

PL99

For 9 modules on 3 vertical rows
w x h x d | 41 x 316 x 376

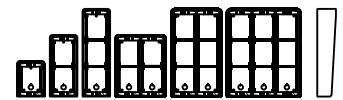

Profilo compositions

one row

Examples of Profilo push-button panel composition in videointercom systems

N°	Calls	Composition and dimensions	Total mod.	Camera module with electric door speaker		Button modules				Blank module		Back boxes with frames	
				N°	Q.ty	Art.	Q.ty	Art.	Q.ty	Art.	Q.ty	Art.	Q.ty
1			1	1	PL41P							1	PL71
2		100 x 142	1	1	PL42P							1	PL71
3			2	1	PL40P	1	PL23					1	PL72
4			2	1	PL40P	1	PL24					1	PL72
5		100 x 253,5	2	1	PL41P	1	PL24					1	PL72
6			2	1	PL42P	1	PL24					1	PL72
7			3	1	PL40P	1	PL24	1	PL23			1	PL73
8			3	1	PL40P	2	PL24					1	PL73
9			3	1	PL41P	2	PL24					1	PL73
10		100 x 365	3	1	PL42P	2	PL24					1	PL73
12			4	1	PL40P	3	PL24					2	PL72
13			4	1	PL41P	3	PL24					2	PL72
14		200 x 253,5	4	1	PL42P	3	PL24					2	PL72
20			6	1	PL40P	5	PL24					2	PL73
22		200 x 365	6	1	PL42P	5	PL24					2	PL73
28			8	1	PL40P	7	PL24					4	PL72
30		400 x 253,5	8	1	PL42P	7	PL24					4	PL72
32			9	1	PL40P	8	PL24					3	PL73
34		300 x 365	9	1	PL42P	8	PL24					3	PL73
40			12	1	PL40P	10	PL24			1	PL23	4	PL73
42			12	1	PL42P	10	PL24			1	PL23	4	PL73
44			12	1	PL40P	11	PL24					4	PL73
46		400 x 365	12	1	PL42P	11	PL24					4	PL73

Examples of Profilo push-button panel composition in 4+1 intercom systems

N°	Calls	N°	Composition and dimensions	Total Mod.	Electric door speaker		Button modules				Blank module		Back boxes with frames	
					N°	Q.ty	Art.	Q.ty	Art.	Q.ty	Art.	Q.ty	Art.	Q.ty
1				1	1	PL11P							1	PL71
2			100 x 142	1	1	PL12P							1	PL71
3				2	1	PL10P	1	PL23					1	PL72
4				2	1	PL10P	1	PL24					1	PL72
5			100 x 253,5	2	1	PL11P	1	PL24					1	PL72
6				2	1	PL12P	1	PL24					1	PL72
7				3	1	PL10P	1	PL24	1	PL23			1	PL73
8				3	1	PL10P	2	PL24					1	PL73
9			100 x 365	3	1	PL11P	2	PL24					1	PL73
10				3	1	PL12P	2	PL24					1	PL73
13				4	1	PL11P	3	PL24					2	PL72
14			200 x 253,5	4	1	PL12P	3	PL24					2	PL72
16				6	1	PL10P	4	PL24					3	PL72
22			300 x 253,5	6	1	PL12P	5	PL24					3	PL72
24				8	1	PL10P	6	PL24			1	PL20	4	PL72
26				8	1	PL10P	6	PL24	1	PL22			4	PL72
28				8	1	PL10P	6	PL24					4	PL72
30			400 x 253,5	8	1	PL12P	7	PL24					4	PL72
32				9	1	PL10P	8	PL24					3	PL73
34			300 x 365	9	1	PL12P	8	PL24					3	PL73
40				12	1	PL10P	10	PL24			1	PL20	4	PL73
44				12	1	PL10P	11	PL24					4	PL73
46			400 x 365	12	1	PL12P	11	PL24					4	PL73

Profilo compositions

two rows

Examples of Profilo push-button panel composition 2-rows in b/w videointercom systems with coax cable

N°	Calls	Composition and dimensions	Total mod.	Camera module with electric door speaker		Button modules		Blank module		Back boxes with frames (*)		Hood covers (*)	
				N°	Q.ty	Art.	Q.ty	Art.	Q.ty	Art.	Q.ty	Art.	Q.ty
2			1	1	PL422P					1	PL71	1	PL81
4		100X142	1	1	PL424P					1	PL71	1	PL81
6			2	1	PL40P	1	PL226			1	PL71	1	PL81
8			2	1	PL40P	1	PL228			1	PL72	1	PL82
10			2	1	PL422P	1	PL228			1	PL72	1	PL82
12		100X253.5	2	1	PL424P	1	PL228			1	PL72	1	PL82
14		100X365	3	1	PL40P	1	PL228	1	PL226	1	PL73	1	PL83
18			3	1	PL424P	1	PL228	1	PL226	1	PL73	1	PL83
20			3	1	PL424P	2	PL228			1	PL73	1	PL83
24			4	1	PL40P	3	PL228			2	PL72	1	PL84
28		200X253.5	4	1	PL424P	3	PL228			2	PL72	1	PL84
30		200X365	6	1	PL40P	3	PL228	1	PL226	1	PL73	1	PL86
36			6	1	PL424P	4	PL228			1	PL73	1	PL86
38			6	1	PL40P	4	PL228	1	PL226	2	PL73	1	PL86
40			6	1	PL40P	5	PL228			2	PL73	1	PL86
52		400x253.5	8	1	PL40P	5	PL228	2	PL226	4	PL72	4	PL82
54			9	1	PL424P	8	PL226			3	PL73	1	PL89
56			9	1	PL40P	7	PL228			1	PL73	1	PL89
60			9	1	PL424P	7	PL228			1	PL73	1	PL89
68		300X365	9	1	PL424P	8	PL228			3	PL73	1	PL89
74			12	1	PL40P	4	PL228	7	PL226	4	PL73	2	PL86
80			12	1	PL40P	7	PL228	4	PL226	4	PL73	2	PL86
86			12	1	PL424P	8	PL228	3	PL226	4	PL73	2	PL86
92		400X365	12	1	PL424P	11	PL228			4	PL73	2	PL86

*OR RAIN SHELTERS FROM PL91 TO PL99 IN CORRESPONDING QUANTITY AND COMPOSITIONS

Examples of Profilo push-button panel composition 2-rows in 4+1 videointercom systems

N°	Calls	Composition and dimensions	Total mod.	Modules with electric door speaker		Button modules		Blank module		Back boxes with frames (*)		Hood covers (*)	
				N°	Q.ty	Art.	Q.ty	Art.	Q.ty	Art.	Q.ty	Art.	Q.ty
2			1	1	PL122P					1	PL71	1	PL81
4		100X142	1	1	PL124P					1	PL71	1	PL81
6			2	1	PL10P	1	PL226			1	PL71	1	PL81
8			2	1	PL122P	1	PL226			1	PL72	1	PL82
10		100X253.5	2	1	PL122P	1	PL228			1	PL72	1	PL82
12			2	1	PL124P	1	PL228			1	PL72	1	PL82
14			3	1	PL10P	1	PL228	1	PL226	1	PL73	1	PL83
18		100X365	3	1	PL124P	1	PL228	1	PL226	1	PL73	1	PL83
20			3	1	PL124P	2	PL228			1	PL73	1	PL83
24			4	1	PL124P	1	PL228	2	PL226	2	PL72	1	PL84
28		200X253.5	4	1	PL124P	3	PL228			2	PL72	1	PL84
30			6	1	PL10P	3	PL228	1	PL226	1	PL73	1	PL86
36			6	1	PL124P	4	PL228			1	PL73	1	PL86
38			6	1	PL10P	4	PL228	1	PL226	2	PL73	1	PL86
40		200X365	6	1	PL10P	5	PL228			2	PL73	1	PL86
52		400x253.5	8	1	PL10P	5	PL228	2	PL226	4	PL72	4	PL82
54			9	1	PL124P	7	PL226	1	PL228	3	PL73	1	PL89
56			9	1	PL10P	7	PL228			1	PL73	1	PL89
60			9	1	PL124P	7	PL228			1	PL73	1	PL89
68		300X365	9	1	PL124P	8	PL228			3	PL73	1	PL89
74			12	1	PL10P	4	PL228	7	PL226	4	PL73	2	PL86
80			12	1	PL10P	7	PL228	4	PL226	4	PL73	2	PL86
86			12	1	PL124P	8	PL228	3	PL226	4	PL73	2	PL86
92		400X365	12	1	PL124P	11	PL228			4	PL73	2	PL86

*OR RAIN SHELTERS FROM PL91 TO PL99 IN CORRESPONDING QUANTITY AND COMPOSITIONS



COMPOSITION FOR VIDEOINTERCOM SYSTEM

Matrix

Solid and antivandal door station series, elegant and reliable with push buttons and modules in stainless steel. Matrix is conceived to be resistant to breaking, water spout and solid penetration, it's guaranteed by IP45 degree for solid items introduction protection and by IK09 degree for mechanical shocks. All the modules are backlit thanks to green LED's for easy identification especially in poorly illuminated situations. The modularity allows installations of great number of users and configurations in vertical or horizontal way. The range is complete with aluminium die cast frames, rain shelters and built-in boxes. In a single module can be integrated push button, door speaker and camera, so that Matrix can be the ideal solution starting from one-way installations up to the most complex cases.

CCD CAMERA MODULES

with orientable lens with 6 LED's and autoiris with electric door speaker integrated. All are with coax cable except for MA43ED

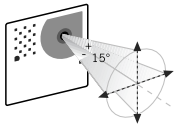

MA42

With door speaker

camera | black/white / fixed 3.6 mm lens

w x h | 115 x 115



MA43

With door speaker and 1 chime button

camera | black/white / fixed 3.6 mm lens

w x h | 115 x 115



MA42C

With door speaker

camera | colour / fixed 3.6 mm lens

w x h | 115 x 115



MA43C

With door speaker and chime button

camera | colour / fixed 3.6 mm lens

w x h | 115 x 115



MA43ED

With door speaker and chime button

for 4+1 electronic call video system without coaxial cable

camera | black/white / fixed 3.6 mm lens

w x h | 115 x 115

MODULES WITH DOOR SPEAKER INTEGRATED

for audio and video systems with electronic or alternate current call and for Digital System FN4000.



MA10P

Without call button

w x h | 115 x 115



MA11P

With 1 call button

w x h | 115 x 115



MA12P

With 2 call buttons

w x h | 115 x 115,

ADDITIONAL BUTTON MODULES



MA22

With 2 call buttons

w x h | 115 x 115



MA24

With 4 call buttons

w x h | 115 x 115

OTHER MODULES



MA20

blank module

w x h | 115 x 115



241DMA

4 diode module to be inserted in button modules MA22, MA24 for reduced wire technology.

FRONT FRAMES

The frames are made of die cast aluminium and they are available in three different sizes according to 1, 2 or 3 module configuration. They are thought to contain modules in vertical or horizontal mounting available in light metallized anthracite colour.

MA61

Front frame for 1 module
w x h | 140 x 140

MA62

Front frame for 2 modules
w x h | 140 x 257

MA63

Front frame for 3 modules
w x h | 140 x 374

Front Frames

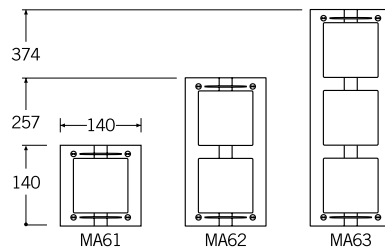

BUILT-IN BACK BOXES

Back boxes are available in three sizes to permit the wall flush mounting installation of 1, 2 and 3 modules. They are provided with metal frames that allow the correct alignment of the function modules. Properly mounted they allow the installation of a great number of users.

MA71

Back box for 1 module
w x h | 128 x 128

MA72

Back box for 2 modules
w x h | 128 x 245

MA73

Back box for 3 modules
w x h | 128 x 362

Built-in back boxes

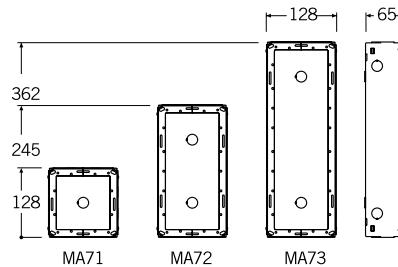

RAIN-SHELTERS

Elegant rain-shelters for surface mounted installations in stainless steel with proper depth and dimensions, that allow to keep the necessary solidity and the fixing with easy and direct mounting of the button modules together with the module frames as decorative elements. According to Matrix range, the rain shelters are available for 1, 2 and 3 modules.

MA91

Rain shelter for 1 module
w x h | 146 x 145

MA92

Rain shelter for 2 modules
w x h | 146 x 262

MA93

Rain shelter for 3 modules
w x h | 146 x 379

Rain-shelters

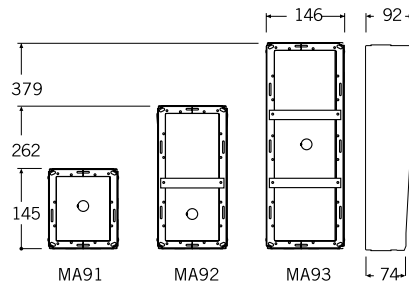



COMPOSITION FOR INTERCOM SYSTEM HORIZONTAL MOUNTING



COMPOSITION FOR VIDEOINTERCOM SYSTEM-HORIZONTAL MOUNTING

Matrix compositions

MATRIX push button panels are born to guarantee reliability, mechanical robustness and elegance to the external door stations. They are also extremely versatile, this is confirmed by several configurations that can be easily obtained. The possibility to assemble the single elements on the horizontal line also give an extra touch of class whenever a certain personalisation is required keeping unchanged mechanical resistance and robustness.

The variety of the compositions achievable with the MATRIX door stations is enhanced by the possibility to assemble the modules even according to an innovative horizontal sequence. Obviously all the mountings are completed by the frames in aluminium die cast that joint to the back boxes in metal guarantees esthetical pleasantness further to practicalness of the audio outdoor station.

The horizontal mountings with the MATRIX series use exactly the same functional elements, including the different camera module versions, as the vertical ones. This choice opportunity gives extra esthetical added value also to the door stations in video version as well. In this way they become very exclusive.

Matrix compositions

Examples of Matrix push-button panel composition in video intercom systems

Call	Composition and dimensions	Total modules	Camera module with electric door speaker				Additional button modules				Blank module		Back boxes and frames		Front frames	
			N°	Q.ty	Art.	Q.ty	Art.	Q.ty	Art.	Q.ty	Art.	Q.ty	Art.	Q.ty	Art.	
1	140 x 140	1	1	MA43								1	MA71	1	MA61	
2	140 x 140	2	1	MA42	1	MA22						1	MA72	1	MA62	
3	140 x 140	2	1	MA43	1	MA22						1	MA72	1	MA62	
4	140 x 140	2	1	MA42	1	MA24						1	MA72	1	MA62	
5	140 x 257	2	1	MA43	1	MA24						1	MA72	1	MA62	
6	140 x 257	3	1	MA42	1	MA24	1	MA22				1	MA73	1	MA63	
7	140 x 257	3	1	MA43	1	MA24	1	MA22				1	MA73	1	MA63	
8	140 x 257	3	1	MA42	2	MA24						1	MA73	1	MA63	
9	140 x 374	3	1	MA43	2	MA24						1	MA73	1	MA63	
10	140 x 374	4	1	MA42	2	MA24	1	MA22				2	MA72	2	MA62	
13	280 x 257	4	1	MA43	3	MA24						2	MA72	2	MA62	
14	280 x 257	6	1	MA42	3	MA24	1	MA22	1	MA22		2	MA73	2	MA63	
16	280 x 257	6	1	MA42	4	MA24				1	MA22	2	MA73	2	MA63	
20	280 x 257	6	1	MA42	5	MA24						2	MA73	2	MA63	
21	280 x 257	6	1	MA43	5	MA24						2	MA73	2	MA63	
22	280 x 257	8	1	MA42	4	MA24	3	MA22				4	MA72	4	MA62	
25	560 x 257	8	1	MA43	5	MA24	2	MA22				4	MA72	4	MA62	
28	560 x 257	9	1	MA42	6	MA24	2	MA22				3	MA73	3	MA63	
30	560 x 257	9	1	MA42	7	MA24	1	MA22				3	MA73	3	MA63	
32	560 x 257	9	1	MA42	8	MA24						3	MA73	3	MA63	
33	560 x 257	9	1	MA43	8	MA24						3	MA73	3	MA63	
38	560 x 257	12	1	MA42	8	MA24	3	MA22				4	MA73	4	MA63	
44	560 x 374	12	1	MA42	11	MA24						4	MA73	4	MA63	
45	560 x 374	12	1	MA43	11	MA24						4	MA73	4	MA63	

Examples of Matrix push-button panel composition in 4+1 intercom systems

Call	Composition and dimensions	Total modules	Modules with electric door speaker				Additional button modules				Back boxes and frames		Front frames	
			N°	Q.ty	Art.	Q.ty	Art.	Q.ty	Art.	Q.ty	Art.	Q.ty	Art.	
1	140 x 140	1	1	MA11P							1	MA71	1	MA61
2	140 x 140	1	1	MA12P							1	MA71	1	MA61
3	140 x 140	2	1	MA11P	1	MA22					1	MA72	1	MA62
4	140 x 140	2	1	MA10P	1	MA24					1	MA72	1	MA62
5	140 x 257	2	1	MA11P	1	MA24					1	MA72	1	MA62
6	140 x 257	2	1	MA12P	1	MA24					1	MA72	1	MA62
7	140 x 257	3	1	MA11P	1	MA24	1	MA22			1	MA73	1	MA63
8	140 x 257	3	1	MA10P	2	MA24					1	MA73	1	MA63
9	140 x 257	3	1	MA11P	2	MA24					1	MA73	1	MA63
10	140 x 374	3	1	MA12P	2	MA24					1	MA73	1	MA63
13	280 x 257	4	1	MA11P	3	MA24					2	MA72	2	MA62
14	280 x 257	4	1	MA12P	3	MA24					2	MA72	2	MA62
16	280 x 257	6	1	MA10P	3	MA24	2	MA22			3	MA72	3	MA62
22	280 x 257	6	1	MA12P	5	MA24					3	MA72	3	MA62
24	560 x 257	8	1	MA12P	4	MA24	3	MA22			4	MA72	4	MA62
26	560 x 257	8	1	MA10P	6	MA24	1	MA22			4	MA72	4	MA62
28	560 x 257	9	1	MA10P	6	MA24	2	MA22			3	MA73	3	MA63
30	560 x 257	9	1	MA12P	6	MA24	2	MA22			3	MA73	3	MA63
32	560 x 257	9	1	MA10P	8	MA24					3	MA73	3	MA63
34	560 x 257	9	1	MA12P	8	MA24					3	MA73	3	MA63
40	560 x 374	12	1	MA10P	9	MA24	2	MA22			4	MA73	4	MA63
44	560 x 374	12	1	MA10P	11	MA24					4	MA73	4	MA63
46	560 x 374	12	1	MA12P	11	MA24					4	MA73	4	MA63



SINGLE ROW COMPOSITION FOR INTERCOM SYSTEM



DOUBLE ROW COMPOSITION FOR VIDEOINTERCOM SYSTEM

MODULES

for electric door speaker - MD30



MD10

Without call buttons

w x h x d | 124 x 90 x 18



MD11

Single-row module, with 1 call button

w x h x d | 124 x 90 x 18



MD12

Single-row module, with 2 call buttons

w x h x d | 124 x 90 x 18



MD122

Double-row module, with 2 call buttons

w x h x d | 124 x 90 x 18



MD124

Double-row module, with 4 call buttons

w x h x d | 124 x 90 x 18

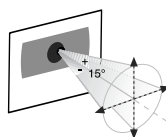

Mody

It's suitable for most of the installation requirements and also for its nicely designed curved lines, Mody series has front plates in extruded aluminium whereas buttons are in stainless steel. The basic elements of this line are camera units, push buttons modules, back boxes, module frames, electric door speakers. For an optimisation of the space exploitation, push buttons are available in one row and two rows as well.

BUTTON MODULES WITH BUILT-IN SPEAKER UNIT

12V ac power supply



MD100

Single-row series, with 1 call button

w x h x d | 124 x 90 x 18



MD200

Single-row series, with 2 call buttons

w x h x d | 124 x 90 x 18

MODULES WITH BUILT-IN SPEAKER UNIT

for 1+1 intercom and 4+1 video intercom systems with electronic call.
12Vac power supply



MD10ED

Without call buttons

w x h x d | 124 x 90 x 18



MD11ED

Single-row module, with 1 call button

w x h x d | 124 x 90 x 18



MD12ED

Single-row module, with 2 call buttons

w x h x d | 124 x 90 x 18

CCD CAMERA MODULES

with 6 infrared LED's and autoiris



MD41

Camera module

camera | black/white / fixed 3.6 mm lens

w x h x d | 124 x 90 x 18



MD41C

Camera module

camera | colour / fixed 5.6 mm lens

w x h x d | 124 x 90 x 18



MD41D









Camera module

camera | black/white / fixed 3.6 mm lens

w x h x d | 124 x 90 x 18

for 4+1 systems without coaxial cable



BUTTON MODULES

-  **MD21**
Single-row module, with 1 call button
w x h x d | 124 x 90 x 18
-  **MD22**
Single-row module, with 2 call buttons
w x h x d | 124 x 90 x 18
-  **MD23**
Single-row module, with 3 call buttons
w x h x d | 124 x 90 x 18
-  **MD24**
Single-row module, with 4 call buttons
w x h x d | 124 x 90 x 18
-  **MD222**
Double-row module, with 2 call buttons
w x h x d | 124 x 90 x 18
-  **MD224**
Double-row module, with 4 call buttons
w x h x d | 124 x 90 x 18
-  **MD226**
Double-row module, with 6 call buttons
w x h x d | 124 x 90 x 18
-  **MD228**
Double-row module, with 8 call buttons
w x h x d | 124 x 90 x 18

By assembling on the mounting elements MD71...MD74, MD81...MD804, MD91...MD904 the button and other modules are on one single row. On the other elements like MD84...MD812, MD94...MD912 the modules are mounted on two or three rows.

KV401 security screw kit is available for Mody series modules.

OTHER MODULES

-  **MD20**
Blank module
w x h x d | 124 x 90 x 18
-  **MD50**
Street number module
w x h x d | 124 x 90 x 18
-  **FC52P**
Access control keypad
w x h x d | 124 x 90 x 18

Keypad with aluminium front plate and buttons in stainless steel. Two relays for lock opening, access control, etc. Keypad for programming and setting relay enable codes. Keypad deactivation with increasing time intervals (max 25 sec.) in case of wrong combination. 4 programmable codes from 2 to 6 digits for each relay. Possibility to activate relay 2 with a single button. Programmable timer from 1 to 99 seconds or bistable operation of relay 1. Two LED's and sound signals indicating correct or incorrect combination and programming. Relay 1 can be activated by pressing an additional Exit button. Power supply 12V ac/dc.

ELECTRIC DOOR SPEAKER

-  **MD30**
Built-in speaker
w x h x d | 91 x 55 x 25,5

Speaker unit for 4+1 audio systems to be placed on the MD10, MD11, MD12, MD122 and MD124 modules.

Back boxes complete with module frames

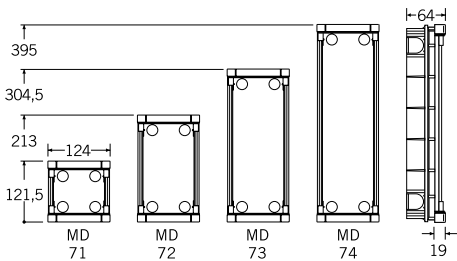

Hood covers

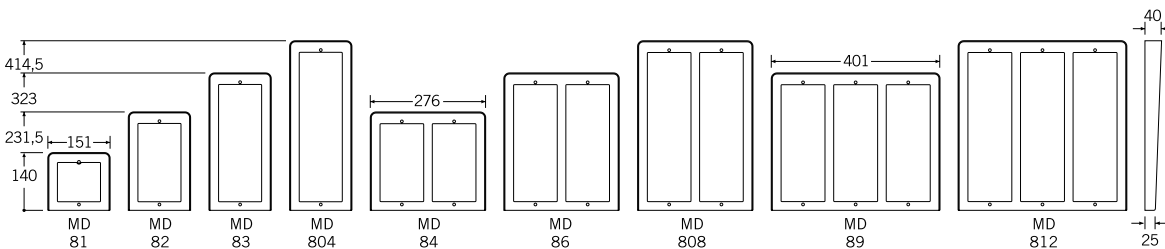



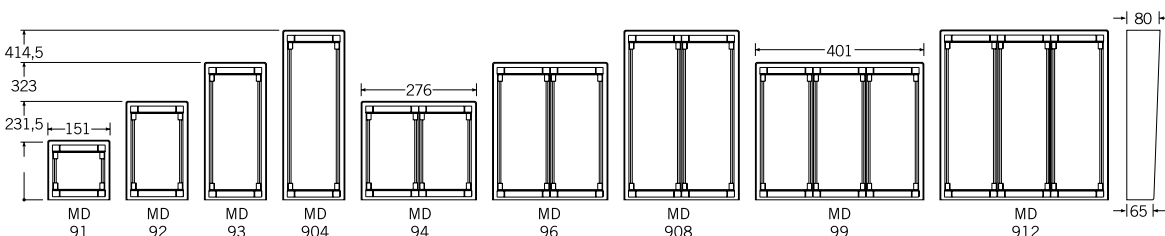





















Rain shelters with module frames



























Mody compositions

single-row

Examples of Mody push-button panel composition in video intercom systems

N°	Composition and dimensions	Total modules		Camera module	Electric door speaker	Electric door speaker module		Button modules		Street number module (*)	(1) Back boxes and frames		(1) Hood covers	
		N°	Q.ty Art.			Q.ty Art.	Q.ty Art.	Q.ty Art.	Q.ty Art.		Q.ty Art.			
1		2	1 MD41	1 MD30	1 MD11					PL71	1 MD72	1 MD82		
2	 124 x 213 x 19	2	1 MD41	1 MD30	1 MD12						1 MD72	1 MD82		
3		3	1 MD41	1 MD30	1 MD10	1 MD23					1 MD73	1 MD83		
4		3	1 MD41	1 MD30	1 MD10		1 MD24				1 MD73	1 MD83		
5		3	1 MD41	1 MD30	1 MD11		1 MD24				1 MD73	1 MD83		
6	 124 x 305 x 19	3	1 MD41	1 MD30	1 MD12		1 MD24				1 MD73	1 MD83		
7		4	1 MD41	1 MD30	1 MD10	1 MD23	1 MD24				2 MD72	1 MD84		
8		4	1 MD41	1 MD30	1 MD10		2 MD24				2 MD72	1 MD84		
9		4	1 MD41	1 MD30	1 MD11		2 MD24				2 MD72	1 MD84		
10	 248 x 213 x 19	4	1 MD41	1 MD30	1 MD12		2 MD24				2 MD72	1 MD84		
12		6	1 MD41	1 MD30	1 MD10		3 MD24	1 MD50			2 MD73	1 MD86		
14		6	1 MD41	1 MD30	1 MD12		3 MD24	1 MD50			2 MD73	1 MD86		
15		6	1 MD41	1 MD30	1 MD10	1 MD23	3 MD24				2 MD73	1 MD86		
18	 248 x 305 x 19	6	1 MD41	1 MD30	1 MD12		4 MD24				2 MD73	1 MD86		
20		8	1 MD41	1 MD30	1 MD10		5 MD24	1 MD50			2 MD74	1 MD808		
22		8	1 MD41	1 MD30	1 MD12		5 MD24	1 MD50			2 MD74	1 MD808		
23		8	1 MD41	1 MD30	1 MD12	1 MD21	5 MD24				2 MD74	1 MD808		
24		8	1 MD41	1 MD30	1 MD12	1 MD22	5 MD24				2 MD74	1 MD808		
26	 248 x 395 x 19	8	1 MD41	1 MD30	1 MD12		6 MD24				2 MD74	1 MD808		
30		9	1 MD41	1 MD30	1 MD12		7 MD24				3 MD73	1 MD89		
35		12	1 MD41	1 MD30	1 MD12	1 MD21	8 MD24	1 MD50			3 MD74	1 MD812		
37		12	1 MD41	1 MD30	1 MD11	2 MD22	8 MD24				3 MD74	1 MD812		
41	 372 x 395 x 19	12	1 MD41	1 MD30	1 MD12	1 MD23	9 MD24				3 MD74	1 MD812		
42		12	1 MD41	1 MD30	1 MD12		10 MD24				3 MD74	1 MD812		

Examples of Mody push-button panel composition in 4+1 intercom systems

N°	Composition and dimensions	N°	Q.ty Art.	Q.ty Art.	Q.ty Art.	Q.ty Art.	Q.ty Art.	Q.ty Art.	Q.ty Art.	Q.ty Art.	Q.ty Art.	Q.ty Art.	Q.ty Art.
1		1		1 MD30	1 MD11							1 MD71	1 MD81
2	 124 x 121,5 x 19	1		1 MD30	1 MD12							1 MD71	1 MD81
3		2		1 MD30	1 MD10	1 MD23						1 MD72	1 MD82
4		2		1 MD30	1 MD10		1 MD24					1 MD72	1 MD82
5	 124 x 213 x 19	2		1 MD30	1 MD11		1 MD24					1 MD72	1 MD82
6		2		1 MD30	1 MD12		1 MD24					1 MD72	1 MD82
7		3		1 MD30	1 MD10	1 MD23	1 MD24					1 MD73	1 MD83
8		3		1 MD30	1 MD10		2 MD24					1 MD73	1 MD83
9		3		1 MD30	1 MD11		2 MD24					1 MD73	1 MD83
10		3		1 MD30	1 MD12		2 MD24					1 MD73	1 MD83
11		4		1 MD30	1 MD10	1 MD23	2 MD24					2 MD72	1 MD84
12		4		1 MD30	1 MD10		3 MD24					2 MD72	1 MD84
13	 248 x 213 x 19	4		1 MD30	1 MD11		3 MD24					2 MD72	1 MD84
14		4		1 MD30	1 MD12		3 MD24					2 MD72	1 MD84
16		6		1 MD30	1 MD10		4 MD24	1 MD50				2 MD73	1 MD86
17		6		1 MD30	1 MD11		4 MD24	1 MD50				2 MD73	1 MD86
18	 248 x 305 x 19	6		1 MD30	1 MD12		4 MD24	1 MD50				2 MD73	1 MD86
20		6		1 MD30	1 MD12	1 MD22	4 MD24					2 MD73	1 MD86
22		6		1 MD30	1 MD12		5 MD24					2 MD73	1 MD86
23	 248 x 395 x 19	8		1 MD30	1 MD10	1 MD23	5 MD24	1 MD50				2 MD74	1 MD808
27		8		1 MD30	1 MD12	1 MD21	6 MD24					2 MD74	1 MD808
30		8		1 MD30	1 MD12		7 MD24					2 MD74	1 MD808
34		9		1 MD30	1 MD12		8 MD24					3 MD73	1 MD89
40	 372 x 395 x 19	12		1 MD30	1 MD12	2 MD21	9 MD24					3 MD74	1 MD812
43		12		1 MD30	1 MD12	1 MD21	10 MD24					3 MD74	1 MD812
46		12		1 MD30	1 MD12		11 MD24					3 MD74	1 MD812

























*OR MD20 BLANK MODULE (OPTIONAL)

*OR MD91...MD912 RAIN SHELTER

























Mody compositions

two-rows

Examples of Mody push-button panel composition in video intercom systems

N°	Composition and dimensions	Total modules	Camera module		Electric door speaker		Electric door speaker module		Button modules		Street number module (*)		(1) Back boxes and frames		(1) Hood covers			
			N°	Q.ty	Art.	Q.ty	Art.	Q.ty	Art.	Q.ty	Art.	Q.ty	Art.	Q.ty	Art.	Q.ty	Art.	
2		2	1	MD41	1	MD30	1	MD122				PL71	1	MD72	1	MD82		
4	 124 x 213 x 19	2	1	MD41	1	MD30	1	MD124					1	MD72	1	MD82		
6		3	1	MD41	1	MD30	1	MD10	1	MD226			1	MD73	1	MD83		
8		3	1	MD41	1	MD30	1	MD10			1	MD228	1	MD73	1	MD83		
10		3	1	MD41	1	MD30	1	MD122			1	MD228	1	MD73	1	MD83		
12	 124 x 305 x 19	3	1	MD41	1	MD30	1	MD124			1	MD228	1	MD73	1	MD83		
14		4	1	MD41	1	MD30	1	MD10	1	MD226	1	MD228	2	MD72	1	MD84		
16		4	1	MD41	1	MD30	1	MD10			2	MD228	2	MD72	1	MD84		
18	 248 x 213 x 19	4	1	MD41	1	MD30	1	MD122			2	MD228	2	MD72	1	MD84		
20		4	1	MD41	1	MD30	1	MD124			2	MD228	2	MD72	1	MD84		
24		6	1	MD41	1	MD30	1	MD10			3	MD228	1	MD50	2	MD73	1	MD86
28		6	1	MD41	1	MD30	1	MD124			3	MD228	1	MD50	2	MD73	1	MD86
30	 248 x 305 x 19	6	1	MD41	1	MD30	1	MD10	1	MD226	3	MD228	2	MD73	1	MD86		
36		6	1	MD41	1	MD30	1	MD124			4	MD228	2	MD73	1	MD86		
40		8	1	MD41	1	MD30	1	MD10			5	MD228	1	MD50	2	MD74	1	MD808
44	 248 x 395 x 19	8	1	MD41	1	MD30	1	MD124			5	MD228	1	MD50	2	MD74	1	MD808
46		8	1	MD41	1	MD30	1	MD124	1	MD222	5	MD228	2	MD74	1	MD808		
48		8	1	MD41	1	MD30	1	MD124	1	MD224	5	MD228	2	MD74	1	MD808		
52		8	1	MD41	1	MD30	1	MD124			6	MD228	2	MD74	1	MD808		
60		9	1	MD41	1	MD30	1	MD124			7	MD228	3	MD73	1	MD89		
70	 248 x 395 x 19	12	1	MD41	1	MD30	1	MD124	1	MD222	8	MD228	1	MD50	3	MD74	1	MD812
74		12	1	MD41	1	MD30	1	MD122	2	MD224	8	MD228	3	MD74	1	MD812		
82		12	1	MD41	1	MD30	1	MD124	1	MD226	9	MD228	3	MD74	1	MD812		
84	 372 x 395 x 19	12	1	MD41	1	MD30	1	MD124			10	MD228	3	MD74	1	MD812		

Examples of Mody push-button panel composition in 4+1 intercom systems

N°	Composition and dimensions	N°	Q.ty	Art.	Q.ty	Art.	Q.ty	Art.	Q.ty	Art.	Q.ty	Art.	Q.ty	Art.	Q.ty	Art.		
2		1			1	MD30	1	MD122					1	MD71	1	MD81		
4	 124 x 121,5 x 19	1			1	MD30	1	MD124					1	MD71	1	MD81		
6		2			1	MD30	1	MD10	1	MD226			1	MD72	1	MD82		
8		2			1	MD30	1	MD10			1	MD228	1	MD72	1	MD82		
10	 124 x 213 x 19	2			1	MD30	1	MD122			1	MD228	1	MD72	1	MD82		
12		2			1	MD30	1	MD124			1	MD228	1	MD72	1	MD82		
14		3			1	MD30	1	MD10	1	MD226	1	MD228	1	MD73	1	MD83		
16		3			1	MD30	1	MD10			2	MD228	1	MD73	1	MD83		
18	 248 x 213 x 19	3			1	MD30	1	MD122			2	MD228	1	MD73	1	MD83		
20		3			1	MD30	1	MD124			2	MD228	1	MD73	1	MD83		
22		4			1	MD30	1	MD10	1	MD226	2	MD228	2	MD72	1	MD84		
24		4			1	MD30	1	MD10			3	MD228	2	MD72	1	MD84		
26	 248 x 213 x 19	4			1	MD30	1	MD122			3	MD228	2	MD72	1	MD84		
28		4			1	MD30	1	MD124			3	MD228	2	MD72	1	MD84		
32		6			1	MD30	1	MD10			4	MD228	1	MD50	2	MD73	1	MD86
34	 248 x 395 x 19	6			1	MD30	1	MD122			4	MD228	1	MD50	2	MD73	1	MD86
36		6			1	MD30	1	MD124			4	MD228	1	MD50	2	MD73	1	MD86
40		6			1	MD30	1	MD124	1	MD224	4	MD228	2	MD73	1	MD86		
44	 248 x 305 x 19	6			1	MD30	1	MD124			5	MD228	2	MD73	1	MD86		
46		8			1	MD30	1	MD10	1	MD226	5	MD228	1	MD50	2	MD74	1	MD808
54	 248 x 395 x 19	8			1	MD30	1	MD124	1	MD222	6	MD228	2	MD74	1	MD808		
60		8			1	MD30	1	MD124			7	MD228	2	MD74	1	MD808		
68		9			1	MD30	1	MD124			8	MD228	3	MD73	1	MD89		
80	 248 x 395 x 19	12			1	MD30	1	MD124	2	MD222	9	MD228	3	MD74	1	MD812		
86		12			1	MD30	1	MD124	1	MD222	10	MD228	3	MD74	1	MD812		
92	372 x 395 x 19	12			1	MD30	1	MD124			11	MD228	3	MD74	1	MD812		

*OR MD20 BLANK MODULE (OPTIONAL)

*OR MD91...MD912 RAIN SHELTER



UP100



UP12

UP

UP's is a Farfisa series for push button panels. It's only for one or two-way audio installations, which mounting can be flush or surface one. Because of the reduced space required, UP is the ideal solution for intercom applications on automatic gates. Front panel in anodised aluminium, name plate backlighting, amplified electric speaker are the basic features of UP series. Flush mounted versions include the corresponding back box, the surface mounted ones include plastic rainshelter. UP11D, UP12D, UP111 and UP211 are available for 1+1 kits with alternate current call only.

plate | 148 x 100 x 2

back box | 138 x 90 x 40

rain shelter for surface mounting | 151 x 106 x 46

UP 11

*flush mounted
1 call button
for 4+1 intercom systems*

UP 12

*flush mounted
2 call buttons
for 4+1 intercom systems*

UP 100

*surface mounted
1 call button
for 4+1 intercom systems*

UP 200

*surface mounted
2 call buttons
for 4+1 intercom systems*

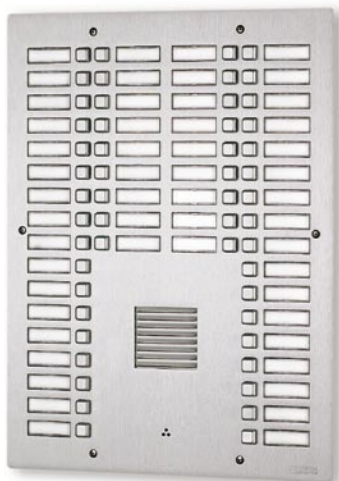

24

RAIN SHELTERS TM SERIES

Made out of aluminium to mount surface TM series push button panels.

Art.	For door stations
290/102	T1M2
290/204	T2M4
290/206	T2M6
290/208	T2M8
290/210	T2M10
290/212	T2M12
290/214	T2M14
290/216	T2M16
290/218	T2M18
290/220	T2M20
290/424	T4M24
290/428	T4M28
290/432	T4M32
290/436	T4M36
290/440	T4M40
290/444	T4M44
290/448	T4M48
290/452	T4M52
290/460	T4M60

TM

Farfisa TM push buttons panels line – a traditional design - can manage a relevant number of users. Front plate is made in 4 mm anticorodal, while chime buttons are in aluminium, name plates are backlit thanks to internal lamps. TM series is ready to have 337C electric door speaker inserted; security screws, depth self-adjusting contact units are present; all these technical characteristics make TM a solid and reliable door station line.

PUSH-BUTTON TM SERIES

Push-button panels with aluminium buttons. Front panel in 4mm anticorodal. Light holder for name plate lighting. Safety screws. Depth self-adjusting contact unit. They are designed to house 337C electric door speaker

Art.	Rows	Ways	Plate mm		Box mm		
			H	W	H	W	D
T1M2	1	2	293	123	282	90	55
T2M4	2	4	293	180	282	160	55
T2M6	2	6	316	180	305	160	55
T2M8	2	8	339	180	328	160	55
T2M10	2	10	362	180	351	160	55
T2M12	2	12	385	180	374	160	55
T2M14	2	14	408	180	397	160	55
T2M16	2	16	431	180	420	160	55
T2M18	2	18	454	180	443	160	55
T2M20	2	20	477	180	466	160	55
T4M24	4	24	293	340	273	320	55
T4M28	4	28	316	340	296	320	55
T4M32	4	32	339	340	319	320	55
T4M36	4	36	362	340	342	320	55
T4M40	4	40	385	340	365	320	55
T4M44	4	44	408	340	388	320	55
T4M48	4	48	431	340	411	320	55
T4M52	4	52	454	340	434	320	55
T4M60	4	60	500	340	480	320	55

LETTER BOXES

Made entirely out of anodised anticorodal aluminium. Provided with name plates and name plate light holder. Front or rear opening for the removal of post. Inside it is possible to insert the 337C electric door speaker and the 1384 camera.

Art.	Type	Open	Way	Dimensions mm		
				H	W	D
250/1	audio	frontal	1	410	200	90
250/2	audio	frontal	2	410	200	90



P102



P214V

ACCESSORIES

SMT 202
Brass single button (external part)

SMT 203
Brass name plate

SMT 204
Plexiglas name plate

Prestige

Amongst its door stations, Farfisa offers Prestige series, that integrates perfectly with elegance and distinct identity in high-class houses; it's the ideal proposal for first-class solutions. Prestige offers brass videointercom or intercom door stations with PVD treatment for conventional installations with MD30 or 337C electric door speakers. Video versions are ready to have colour MD41C or b/w MD41 camera inserted. Brass name plates are provided for name engraving, also plexiglas name plates are available.

Push-button panels for video intercoms systems

Art.	Rows	Way.	Plate mm		Box mm		
			H	W	W	H	D
P101V	1	1	339	135	90	328	55
P102V	1	2	362	135	90	351	55
P103V	1	3	385	135	90	374	55
P104V	1	4	408	135	90	397	55
P106V	1	6	454	135	90	443	55
P208V	2	8	408	180	155	397	55
P210V	2	10	431	180	155	420	55
P214V	2	14	477	180	155	466	55
P218V	2	18	523	180	155	512	55
P222V	2	22	569	180	155	558	55

Push-button panels for intercoms systems

Art.	Rows	Ways	Plate mm		Box mm		
			H	W	W	H	D
P101	1	1	247	100	90	236	55
P102	1	2	270	100	90	259	55
P103	1	3	293	100	90	282	55
P104	1	4	316	100	90	305	55
P106	1	6	362	100	90	351	55
P108	1	8	408	100	90	397	55
P210	2	10	339	180	155	328	55
P214	2	14	385	180	155	374	55
P218	2	18	431	180	155	420	55
P222	2	22	477	180	155	466	55

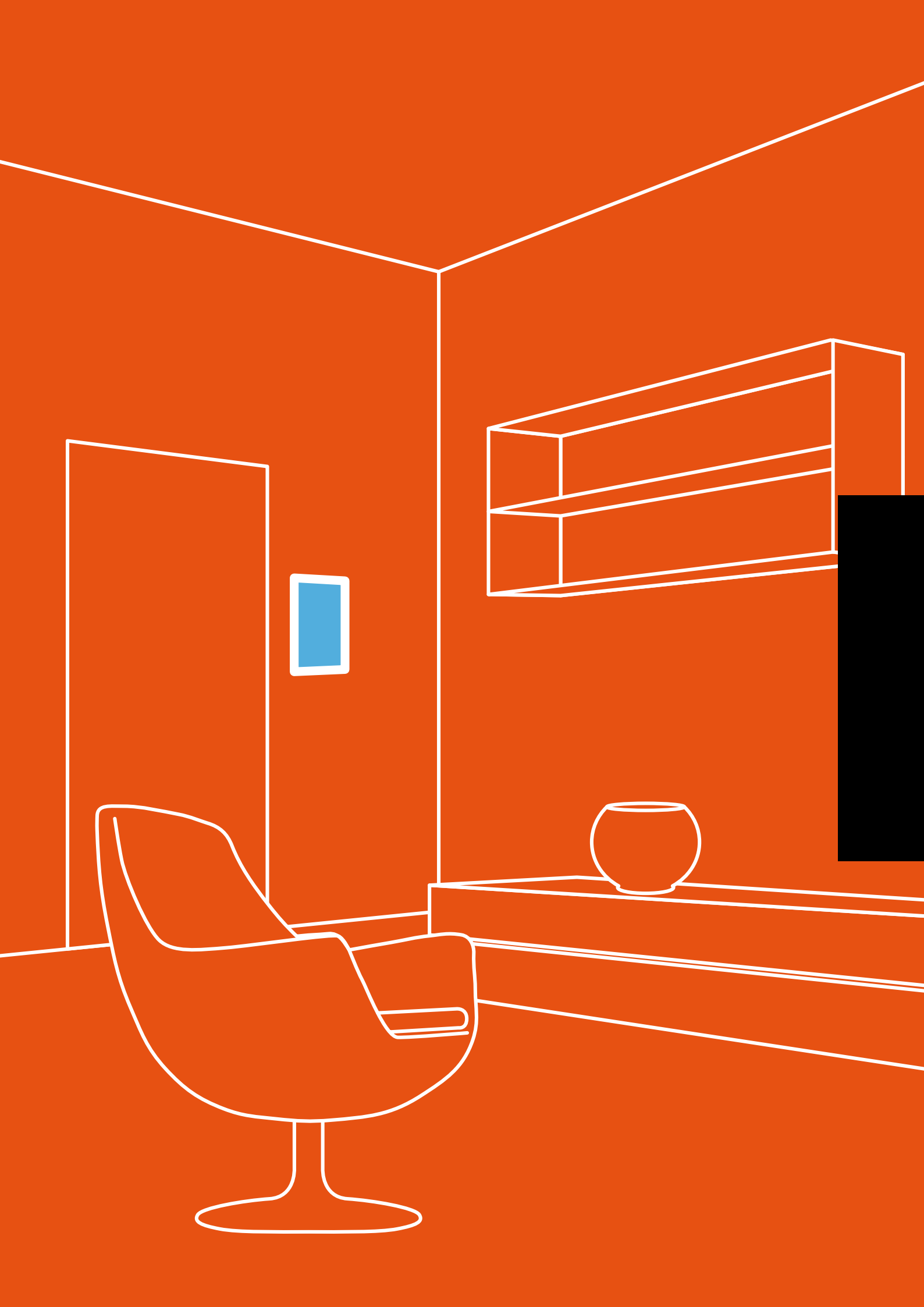

Videointercoms



Colour electronic call	Echos	28
Colour electronic call	Compact	30
Colour electronic call	Studio	31
B/W electronic call	Compact	32
B/W electronic call	Studio	33
Colour electronic call	Compact 4+1	34
B/W electronic call	Compact 4+1	35
B/W electronic call	Project 4+1	36
Colour alternate current call	Project	37
B/W alternate current call	Project	38
Service modules		39
Videointercom Kits		40

New ECHOS series updates and even enhances the wide FARFISA videointercom offer, the new LCD hand-free models are marked by an innovative and quite modern design. Colour and b/w Aci Farfisa monitors meet any installation request or features need. Moreover they can be used for basic systems up to large installations where high quality and functionality levels are definitely a must.



ECHOS

New Echos range models have been conceived in colour version, with 3.5" LCD screen, adjustable on horizontal axis for the best adaptability to avoid any light reflexes. Also this feature is very exploitable to properly adjust screen position according to the user tallness. Main feature of this monitor is its hand-free and open voice operation, no handset is required. Function-buttons on the front are intuitive: door-opening, display turn-on, chime exclusion (with LED for setting indication), volume and picture brightness adjustment, intercommunication service and additional functions. Technology used is based on electronic call one for the best quality. For the time being it's thought for conventional wiring. It can be perfectly combined with Profilo and Matrix door stations and it's available in video kit version for one-way solutions.



EH9160CW



EH9160CT



EH9100CW

EH9100CW

Videointercom with 2 push buttons

screen | colour

colour | white and grey

w x h x d | 103 X 209 X 26

Hand-free videointercom with adjustable 3.5" LCD screen. Supplied with buttons for open voice conversation On/Off, door-opening, chime exclusion (with LED for setting indication) and two buttons for intercommunicating service. User's interface has keys for audio volume and brightness adjustment.

EH9160CW

Videointercom with 6 push buttons

screen | colour

colour | white and grey

w x h x d | 103 X 209 X 26

Hand-free videointercom with adjustable 3.5" LCD screen. Supplied with buttons for open voice conversation On/Off, door-opening, chime exclusion (with LED for setting indication) and six buttons for intercommunicating service. User's interface shows keys for audio volume and brightness adjustment.

EH9100CT

Videointercom with 2 push buttons

screen | colour

colour | metalized grey

w x h x d | 103 X 209 X 26

Hand-free videointercom with adjustable 3.5" LCD screen. Supplied with buttons for open voice conversation On/Off, door-opening, chime exclusion (with LED for setting indication) and two buttons for intercommunicating service. User's interface has keys for audio volume and brightness adjustment.

EH9160CT

Videointercom with 6 push buttons

screen | colour

colour | metalized grey

w x h x d | 103 X 209 X 26

Hand-free videointercom with adjustable 3.5" LCD screen. Supplied with buttons for open voice conversation On/Off, door-opening, chime exclusion (with LED for setting indication) and six buttons for intercommunicating service. User's interface shows keys for audio volume and brightness adjustment.

BACK BOX**9083**

built-in back box for EH9100CW, EH9160CW, EH9100CT e EH9160CT.

w x h x d | 192 x 92 x 46

WALL ADAPTOR**WA9100W**

wall adaptor for surface mounting of EH9100CW and EH9160CW

colour | white

WA9100T

wall adaptor for surface mounting of EH9100CT e EH9160CT

colour | metalized grey

POWER SUPPLY**1281**

Stabilised power supply 230-127V ac, 48VA, outputs protected against overloading and short circuits, able to supply power to 1 camera unit and 2 FLAT or LCD video intercoms connected in parallel, or 1 camera unit and 1 video intercom (not FLAT). Output voltages: 13V ac and 21V dc. Certification: VDE. 8 A modules on DIN bar.

TIMER**1282E**

Audio-Video timer. Allows operation in timer mode of a video system with electronic call, automatic deletion at the end of the conversation and the switching on of one video intercom at a time. Mountable on 6 A DIN module. Art. 1281 and 1282E can be used instead of 1281E in case of intercommunicating service or automatic switch-off of conversation are required.



KM8100CW

COMPACT

Colour Compact version offers the model which exploits the coax cable as transmission mean for the video signal. Audio best quality is guaranteed by electronic call technology that reduces line interference. Compact line – elegant and discreet – can be suitable to many different interior design, while system allows operation with all Farfisa door station ranges.

30

KM8100CW

Videointercom flat

screen | colour

colour | white

w x h x d | 201 x 229 x 88

Videointercom with colour 4" flat screen for wall surface mounting, white colour. Supplied with three buttons for door-opening, display turn-on and additional services. It allows two distinguished chimes for call from landing and from door station.

Multi-way videointercom system with audio-video entrances automatically switched

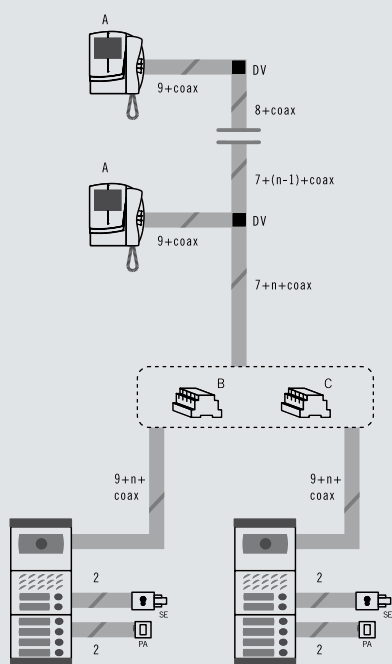

A
KM8100CW
WB8600

B
1281E

C
1473

D
Mody

ACCESSORIES



WB8600

Wall bracket with terminal boards for electrical connections and wall mounting of KM8100CW and KM8100W monitors.

POWER SUPPLIES

1281

Stabilised power supply 230-127V ac, 48VA, outputs protected against overloading and short circuits, able to supply power to 1 camera unit and 2 FLAT or LCD video intercoms connected in parallel, or 1 camera unit and 1 video intercom (not FLAT). Output voltages: 13V ac and 21V dc. Certification: VDE. 8 A modules on DIN bar.

1281E

Power supply with timer integrated 230-127Vac/48VA outputs protected against overloading and short circuits. Provided with note generator for videointercom systems with electronic call for Studio and Compact line. Output voltages: 13Vac and 21Vdc. Certification: VDE. 8A modules on DIN bar.

TIMER

1282E

Audio-Video timer. Allows operation in timer mode of a video system with electronic call, automatic deletion at the end of the conversation and the switching on of one video intercom at a time. Mountable on 6 A DIN module. Art. 1281 and 1282E can be used instead of 1281E in case of intercommunicating service or automatic switch-off of conversation are required.



ST7100CW + ST720W

ST7100CW

Monitor module
screen | colour
colour | white
w x h x d | 156 x 224 x 61

Monitor Studio series in white colour with button for Control switch on and one supplementary button. The 4" LCD colour monitor can be adjusted in inclination. Video signal input with coaxial cable or by balanced line.

ST720W

Intercom module
colour | white
w x h x d | 93 x 209 x 67

Intercom with spiral cord, door lock release button. Up to six buttons or accessories can be added enhancing the available functions. It can be used in electronic call systems, intercommunicating or Digital FN4000.

VIDEO MEMORY

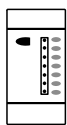

ST7M32W

colour | white
w x h x d | 93 x 183 x 43

Video memory module series Studio. It can store up to 32 b/w pictures. Video input signal with coaxial cable or by balanced line.

FIXING ELEMENTS

WB7100

Wall bracket for monitors ST7100W and ST7100CW

WB700

Wall bracket for series Studio modules and ST740W intercom telephone set. For intercom ST720W when connected to the monitor module.

POWER SUPPLY

1281

Stabilised power supply 230-127V ac, 48VA, outputs protected against overloading and short circuits, able to supply power to 1 camera unit and 2 FLAT or LCD video intercoms connected in parallel, or 1 camera unit and 1 video intercom (not FLAT). Output voltages: 13V ac and 21V dc. Certification: VDE. 8 A modules on DIN bar.

STUDIO

Modular videointercom system Studio -composed by colour monitor and handset- can be used for coax cable or balanced line installations. The system can be combined with 32 pictures memory module that records and reproduces b/w images. It can be used with all Farfisa door stations.

TIMER

1282E

Audio-Video timer. Allows operation in timer mode of a video system with electronic call, automatic deletion at the end of the conversation and the switching on of one video intercom at a time. Mountable on 6 A DIN module. Art. 1281 and 1282E can be used instead of 1281E in case of intercommunicating service or automatic switch-off of conversation are required.

ACCESSORIES

TA700W

Table adapter in white colour for accessories Studio series, intercom and intercom-telephone set, when in composition. Complete with cable clamp, plastic and metallic frames for correct alignment with TA7100W and/or further TA700W or TA720W. To be mounted with WB700 wall bracket.



TA7100W

Table adapter in white colour for ST7100W and ST7100CW monitor. Complete with cable clamp, junction box and 2.4 m connection cable with 20 wires. To be mounted with WB7100 wall bracket.



Multi-way colour videointercom system with secondary audio-video entrances and 1 common audio-video entrance (risers of buildings)

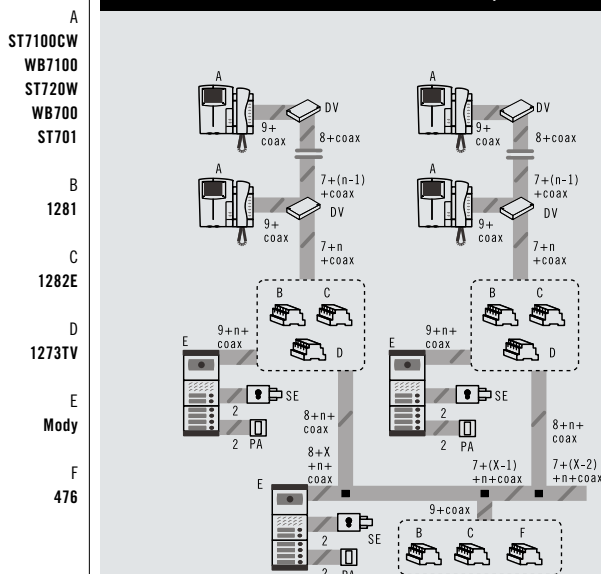



KM8100W

KM8100W*Flat Videointercom*

screen | b/w

colour | white

w x h x d | 201 x 229 x 88

Videointercom with 4" b/w Flat tube for wall surface mounting. It is equipped with three push buttons for electric lock release, auto switching and supplementary services. It allows two differentiated chime sounds for calls from the door station and from front door.

COMPACT

B/w solution for Compact series exploits coax cable technology as transmission mean for video signal, further audio quality is guaranteed by electronic call. It can be combined with all Farfisa door stations and it's available in video kit version for easier and more practical installations.

ACCESSORIES**WB8600**

Wall bracket with terminal boards for electrical connections and wall mounting of KM8100W.

POWER SUPPLIES**1281**

Stabilised power supply 230-127V ac, 48VA, outputs protected against overloading and short circuits, able to supply power to 1 camera unit and 2 FLAT or LCD video intercoms connected in parallel, or 1 camera unit and 1 video intercom (not FLAT). Output voltages: 13V ac and 21V dc. Certification: VDE. 8 A modules on DIN bar.

1281E

Power supply with timer integrated 230-127Vac/48VA outputs protected against overloading and short circuits. Provided with note generator for videointercom systems with electronic call for Studio and Compact line. Output voltages: 13Vac and 21Vdc. Certification: VDE. 8A modules on DIN bar.

TIMER**1282E**

Audio-Video timer. Allows operation in timer mode of a video system with electronic call, automatic deletion at the end of the conversation and the switching on of one video intercom at a time. Mountable on 6 A DIN module. Art. 1281 and 1282E can be used instead of 1281E in case of intercommunicating service or automatic switch-off of conversation are required.



ST7100W + ST720W

ST7100W

Monitor module
screen | b/w
colour | white
w x h x d | 156 x 224 x 61

Monitor Studio series in white colour with button for Control switch on and one supplementary button. The 4" LCD colour monitor can be adjusted in inclination. Video signal input with coaxial cable or by balanced line.

ST720W

Intercom module
colour | white
w x h x d | 93 x 209 x 67

Intercom of Studio series in white colour and with spiral cord, door lock release button. Up to six button or accessories can be added enhancing the available functions. It can be used for electronic call or FN4000 systems.

VIDEO MEMORY

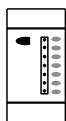

ST7M32W
colour | white
w x h x d | 93 x 183 x 43

Video memory module series Studio. It can store up to 32 b/w pictures. Video input signal with coaxial cable or by balanced line.

FIXING ELEMENTS

WB7100
Wall bracket for monitors ST7100W and ST7100CW

WB700
Wall bracket for series Studio modules and ST740W intercom telephone set. For intercom ST720W when connected to the monitor module.

POWER SUPPLY

1281
Stabilised power supply 230-127V ac, 48VA, outputs protected against overloading and short circuits, able to supply power to 1 camera unit and 2 FLAT or LCD video intercoms connected in parallel, or 1 camera unit and 1 video intercom (not FLAT). Output voltages: 13V ac and 21V dc. Certification: VDE. 8 A modules on DIN bar.

STUDIO

Modular Studio internal stations offer for b/w videointercom section the monitor combined to the intercom, by using coax cable or balanced line as transmission mean of video signal. Studio monitor can be integrated with video memory module that reproduces up to 32 pictures.

TIMER

1282E
Audio-Video timer. Allows operation in timer mode of a video system with electronic call, automatic deletion at the end of the conversation and the switching on of one video intercom at a time. Mountable on 6 A DIN module. Art. 1281 and 1282E can be used instead of 1281E in case of intercommunicating service or automatic switch-off of conversation are required.

ACCESSORIES



TA700W
Table adapter in white colour for accessories Studio series, intercom and intercom-telephone set, when in composition. Complete with cable clamp, plastic and metallic frames for correct alignment with TA7100W and/or further TA700W or TA720W. To be mounted with WB700 wall bracket.



TA7100W
Table adapter in white colour for ST7100W and ST7100CW monitor. Complete with cable clamp, junction box and 2,4 m connection cable with 20 wires. To be mounted with WB7100 wall bracket.

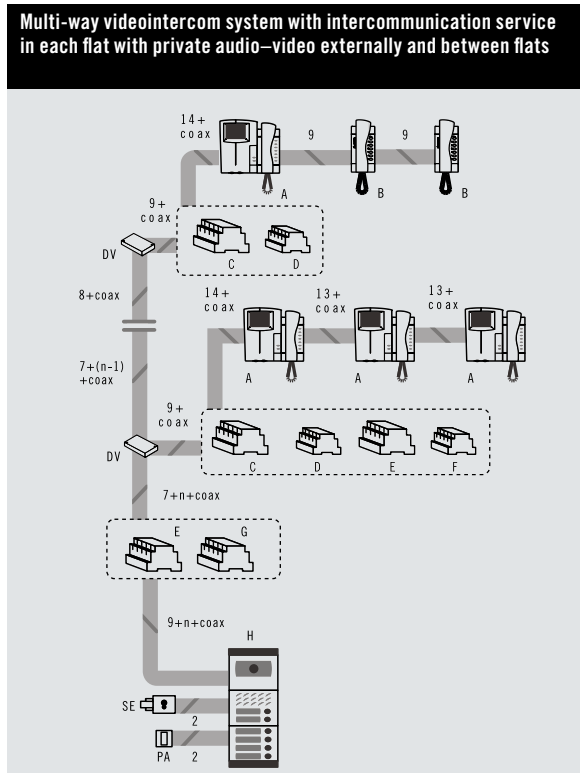



KM8111CW

COMPACT 4+1

Aci Farfisa offers for the first time colour Compact model for 4+1 wiring systems, where the installation is made by 4 cables only for all the internal video stations plus 1 for each apparatus, this means with no coax cable. Electronic call technology gives audio high quality. This monitor can be properly combined with door stations of Mody, Profilo and Matrix series.

KM8111CW

Flat Videointercom

screen | colour

colour | white

w x h x d | 201x 229 x 88

Colour videointercom with 4" flat screen for wall mounting. Supplied with three buttons for door-opening, display turn-on and additional services. It allows to get different chimes coming respectively from the landing or from door station.

Multi-way mixed intercom-videointercom system with audio-video privacy, video system 4+1

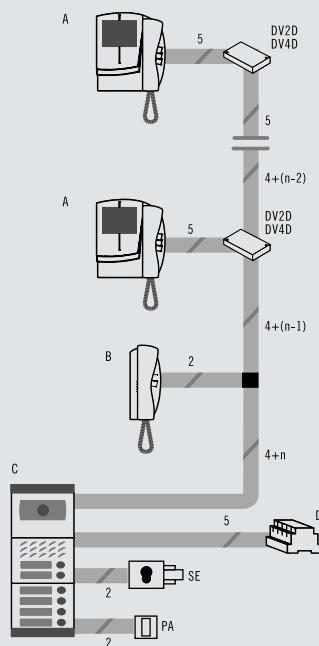

- A KM8111CW
WB8111
- B KM811W
- C Mody
- D 1181E

ACCESSORIES



WB8111

Wall bracket with terminal boards for electrical connections and wall mounting of KM8111W and KM8111CW monitors

POWER SUPPLY



1181E

Timed power supply - 127-230V ac. 48VA outputs protected against overloading and short circuits, able to supply timed power to 1 camera unit and 2 Compact video intercoms connected in parallel. Output voltages: 13V ac and 21V dc. Certification: VDE. 8 A modules on DIN bar.

SERVICE MODULES



DV2D

2-output floor distributor. Power supply: 21Vdc.

DV4D

4-output floor distributor. Power supply: 21Vdc.

241D

2-diode module to be inserted in button modules MD21, MD22, MD23, MD222, MD224, MD226, MD228.

241DMA

4-diode module to be inserted in button modules PL21, PL22, PL23, PL24 and MA22, MA24.



KM8111W

KM8111W

Flat Videointercom

screen | b/w

colour | white

w x h x d | 201 x 229 x 88

Videointercom with 4" b/w Flat tube for wall surface mounting, for 4+1 video installations. It is equipped with three push buttons for electric lock release, auto switching and supplementary services. It allows two differentiated chime sounds for calls from the door station and from front door.

Multi-way videointercom system with secondary audio-video entrances and one common audio-video entrance 4+1 system.

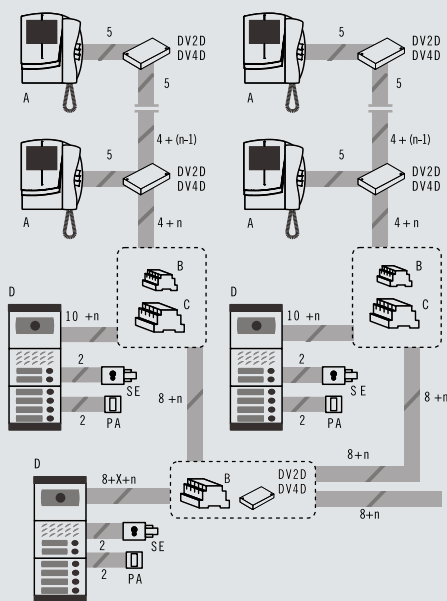

- A KM8111W
WB8111
- B 1181E
- C 1473
- D Mody

COMPACT 4+1

B/w Compact videointercom allows installations with electronic call with 4 wires only for all the video internal stations plus 1 common for each apparatus, without coax cable. The line guarantees operation properly combined with door stations of Profilo, Matrix and Mody range.

ACCESSORIES



WB8111

Wall bracket with terminal boards for electrical connections and wall mounting of the monitor KM8111W and KM8111CW

POWER SUPPLY



1181E

Timed power supply - 127-230V ac. 48VA outputs protected against overloading and short circuits, able to supply timed power to 1 camera unit and 2 Compact video intercoms connected in parallel. Output voltages: 13V ac and 21V dc. Certification: VDE. 8 A modules on DIN bar.

SERVICE MODULES

DV2D

2-output floor distributor. Power supply: 21Vdc.

DV4D

4-output floor distributor. Power supply: 21Vdc.

241D

2-diode module to be inserted in button modules MD21, MD22, MD23, MD222, MD224, MD226, MD228.

241DMA

4-diode module to be inserted in button modules PL21, PL22, PL23, PL24 and MA22, MA24.



PT5111EW

PT5111EW

Flat Videointercom

screen | b/w

colour | white

w x h x d | 215 x 215 x 89

Surface mounted FLAT video intercom with 4" B/W monitor, electronic ringer and microphone. 2 buttons for door-open and Camera Recall.

Multi-way videointercom system with secondary audio-video entrances and one common audio-video entrance 4+1 system.

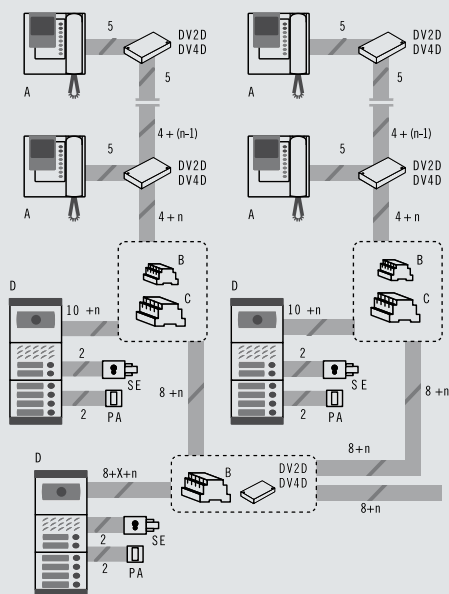

- A PT5111EW
WB5111E
- B 1181E
- C 1473
- D Mody

PROJECT 4+1

Farfisa offer includes even Project line for videointercom installation with electronic call. Monitors are connected to 4 cables common for all the installation apparatus plus 1 for each videointercom, without requiring coax cable. The system allows audio-video and door-opening features guaranteeing audio-video privacy. Perfect combination with appropriate modules of Profilo, Matrix and Mody door stations is guaranteed.

POWER SUPPLIE



1181E

Timed power supply - 127-230V ac. 48VA outputs protected against overloading and short circuits, able to supply timed power to 1 camera unit and 2 Compact video intercoms connected in parallel. Output voltages: 13V ac and 21V dc. Certification: VDE. 8 A modules on DIN bar.

FIXING ELEMENTS



WB5111E

Bracket with terminal board for wall-mounting of PT5111EW monitor.

SERVICE MODULES

DV2D

2-output floor distributor. Power supply: 21Vdc.

DV4D

4-output floor distributor. Power supply: 21Vdc.

241D

2-diode module to be inserted in button modules MD21, MD22, MD23, MD222, MD224, MD226, MD228.

241DMA

4-diode module to be inserted in button modules PL21, PL22, PL23, PL24 and MA22, MA24.



PT5160W-LCD

PT5160W-LCD*Flat Videointercom*

screen | colour

colour | white

w x h x d | 215 x 215 x 89

Surface mounted video intercom with LCD 4" colour screen. Applied to all video systems with coaxial cable. Used together with the MD41C colour camera. Also compatible with black and white cameras. Equipped with 2 buttons, for door-open and Camera Recall, and differentiated call tone. It is also supplied with 6 additional buttons for supplementary services. To use the additional buttons and to have differentiated call tone, use the WB5160 bracket.

PROJECT

When the technology system is with alternate current call, Farfisa guarantees compatibility of Project videointercoms, even in colour version. The range – which design is classic and curved-line – is suitable to many different domestic environments.

FIXING ELEMENTS**WB5100**

Wall-mounting bracket for video intercom system PT5160W-LCD. For 2 non-extendable buttons.

**WB5160**

Replaces the previous bracket when additional buttons and/or secondary call tone necessary.

TA5160

Desk adapter with 20-wire connection cable and fixing bracket for PT5160W-LCD video intercom. It can be used in both the basic applications and in applications with additional buttons and/or secondary call tone.

POWER SUPPLIES**1281**

Stabilised power supply 230-127V ac, 48VA, outputs protected against overloading and short circuits, able to supply power to 1 camera unit and 2 FLAT or LCD video intercoms connected in parallel, or 1 camera unit and 1 video intercom (not FLAT). Output voltages: 13V ac and 21V DC. Certification: VDE. 8 A modules on DIN bar.

1381

Stabilised power supply 127-127 V ac, 65VA, outputs protected against overloading and short circuits. Output voltages: 13 VAC and 24 Vdc.



PT5160W

PROJECT

For videointercom systems with alternate current call technology, b/w Project model is available. Project line classic design guarantees a perfect suitability to most of the interior design.

38

PT5160W

Flat Videointercom

screen | b/w

colour | white

w x h x d | 215 x 215 x 89

Surface mounted Flat video intercom with 4" monitor. Equipped with 2 buttons, one for door-opener and one for Camera Recall, and secondary call tone. Also supplied with 6 additional buttons for supplementary services. To use the additional buttons and have secondary call tone, use the WB5160 bracket.

FIXING ELEMENTS



WB5100

Wall-mounting bracket for video intercom system PT5160W. For 2 non-extendable buttons.

WB5160

Replaces the previous bracket when additional buttons and/or secondary call tone necessary.

TA5160

Desk adapter with 20-wire connection cable and fixing bracket for PT5160W video intercom. It can be used in both the basic applications and in applications with additional buttons and/or secondary call tone.

Multi-way videointercom system with audio-video entrances automatically switched

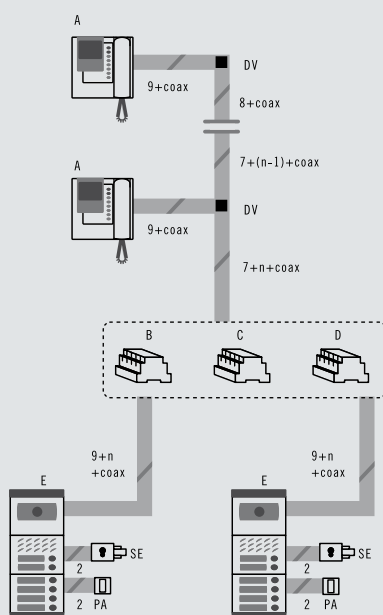

A
PT5160W
WB5160

B
1281

C
1382

D
1473

E
Mody



SERVICE MODULES

476

Video amplifier-distributor with 1 input and 5 outputs. Power supply: 21-24V dc. 8 A modules on DIN bar.

1273TV

7-exchange exchanger for automatic switching of 2 audio-video inputs. 8 A modules in DIN bar.

1304

Multipolar cable for video intercom systems with a maximum extension of 100m. Made up of 10 wires of different sections and 75Ω coaxial cable.

1382

Audio-video timer. Allows operation in timer mode of a video intercom system, automatic deletion at the end of the conversation and the switching-on of one video intercom at a time. 6 A modules on DIN bar.

1384

B/W CCD camera module. With 6 infrared LED, autoiris and 3,6 mm fixed lens.

CV02

Placed inside the external door station, it sounds in case of effected calling.

1443E

Intercommunication service module to be inserted inside the 1282E timer. It can be used when there is only one intercommunication service in the system.

SERVICE MODULES

Farfisa offers some service modules as components of videointercom systems with conventional wiring.

1472

2-exchange exchanger (1A, 24V) 3 command input: 12 Vdc/Vac, 24 Vdc and electronic note. Mountable on 3 A DIN module.

1473

4-exchange exchanger for automatic switching of 2 inputs. 8 A modules in DIN bar. Used in 4+1 video systems or in systems with an audio-only second input.

2443

Audio relay-amplifier for intercommunication video systems. 4 A modules on DIN bar. It can be used in video systems with several users with the intercommunication service.

DV2

2-output video distributor. Power supply: 12V dc.

DV4

4-output video distributor. Power supply: 12V dc.

RL37

It can drive the chime for intercoms and videointercoms, mountable on 4 A DIN module. One free supplementary contact is available, with electronic note.

CV01

It can be inserted inside Mody and Matrix push button panels, it allows to convert from video signal by non-balanced line to video signal by balanced line.

VIDEOINTERCOM KITS

Videointercom kits include all the required items for one-way or two-way installations. The components are properly selected into the list of available articles in the catalogue, keeping features and quality as per the multi-way systems.

COAX CABLE TECHNOLOGY ELECTRONIC CALL

KITS ECHOS-PROFILO SERIES

With hand-free LCD videointercom

EH9160PLCW

one-way/white videointercom

KITS COMPACT-PROFILO SERIES

With flat videointercom

KM8100PLCW

one-way/LCD white videointercom

KM8100PLW

one-way / white videointercom

KITS COMPACT-MATRIX SERIES

With flat videointercom

KM8100MXW

one-way/white videointercom

KITS COMPACT-MODY SERIES

With flat videointercom

KM8100MDW

One-way/white videointercom

KM8100MDW/2

Two-way/white videointercom

KITS STUDIO-MODY SERIES

With flat videointercom for surface mounting, video signal also by pair cable

ST7100MDCW

one-way/white LCD videointercom

ST7100MDW

one-way/white videointercom

KITS MODY-PROJECT SERIES

With flat videointercom for surface mounting

PT5100MDCW

One-way/white LCD videointercom

PT5100MDW

One-way/white videointercom

PT5100MDW/2

Two-way/white videointercom

PT5160MDW-LCD

One-way/white LCD videointercom

PT5160MDW

One-way/white videointercom



EH9160PLCW



KM8100PLW



KM8100MXW



PT5111EDW



1FEV/4

4+1 TECHNOLOGY WITHOUT COAX CABLE ELECTRONIC CALL

KITS COMPACT-MODY SERIES

KM8111MDW

One-way/white videointercom

KM8111MDW/2

Two-way/white videointercom

KITS MODY-PROJECT SERIES

With flat videointercom for surface mounting

PT5111EDW

One-way/white videointercom

2-WIRE TECHNOLOGY

Two wires between the video intercom and the external door station are enough for a complete one way video intercom system. The monitor includes the power supply and it is equipped with plug for direct connection to the mains. It can easily extended up to 4 internal stations by adding a slave Monitor FEVS. Intercommunication facility is also available. Surface mounted white Master video intercom. For the door-opener add the PRS210 transformer.

KIT 1FEV/4

Video intercom kit expandable with flush mounted aluminium video door station

KIT 1FEVP/4

Video intercom kit expandable with surface mounted plastic video door station

FEVS

Monitor slave to extend the number (max. 3 Units) of the video stations. Intercommunication service is available

290/1F

Rain shelter for 1FEV/4 kit

VIDEOINTERCOM KIT COMPOSITION

VIDEO KIT	DOOR STATION	INTERNAL STATION	POWER SUPPLY	INSTALLATION SYSTEM
EH9160PLCW	PL41C+PL71	EH9160CW+9083	1281E	One-way with coax cable
KM8100PLCW	PL41PC+PL71	KM8100CW+WB8600	1281E	One-way with coax cable
KM8100PLW	PL41P+PL71	KM8100W+WB8600	1281E	One-way with coax cable
KM8100MXW	MA43+MA71+MA61	KM8100W+WB8600	1281E	One-way with coax cable
KM8100MDW	MD72+MD11+MD41+MD30	KM8100W+WB8600	1281E	One-way with coax cable
KM8100MDW/2	MD72+MD12+MD41+MD30	2XKM8100W+WB8600	1281E	Two-way with coax cable
KM8111MDW	MD11ED+MD41D+MD72	KM8111W+WB8111	1181E	One-way without coax cable
KM8111MDW/2	MD12ED+MD41D+MD72	2xKM8111W+WB8111	1181E	Two-way with coax cable
ST7100MDCW	MD72+MD11+MD41C+MD30	ST7100CW+ST720W+WB7100+WB700	1282E+1281	One-way with coax cable
ST7100MDW	MD72+MD11+MD41+MD30	ST7100W+ST720W+WB7100+WB700	1282E+1281	One-way with coax cable
PT5100MDCW	MD72+MD11+MD41C+MD30	PT5160W-LCD+WB5100	1281+1382	One-way with coax cable
PT5100MDW	MD72+MD11+MD41+MD30	PT5160W+WB5100	1281+1382	One-way with coax cable
PT5100MDW/2	MD72+MD12+MD41+MD30	2XPT5160W+WB5100	1281+1382	One-way with coax cable
PT5160MDW-LCD	MD72+MD11+MD41C+MD30	PT5160W-LCD+WB5160	1281+1382	One-way with coax cable
PT5160MDW	MD72+MD11+MD41+MD30	PT5160W+WB5160	1281+1382+1443E	One-way with coax cable
PT5111EDW	MD72+MD11ED+MD41D	PT5111EW+WB5111E	1181E	One-way without coax cable

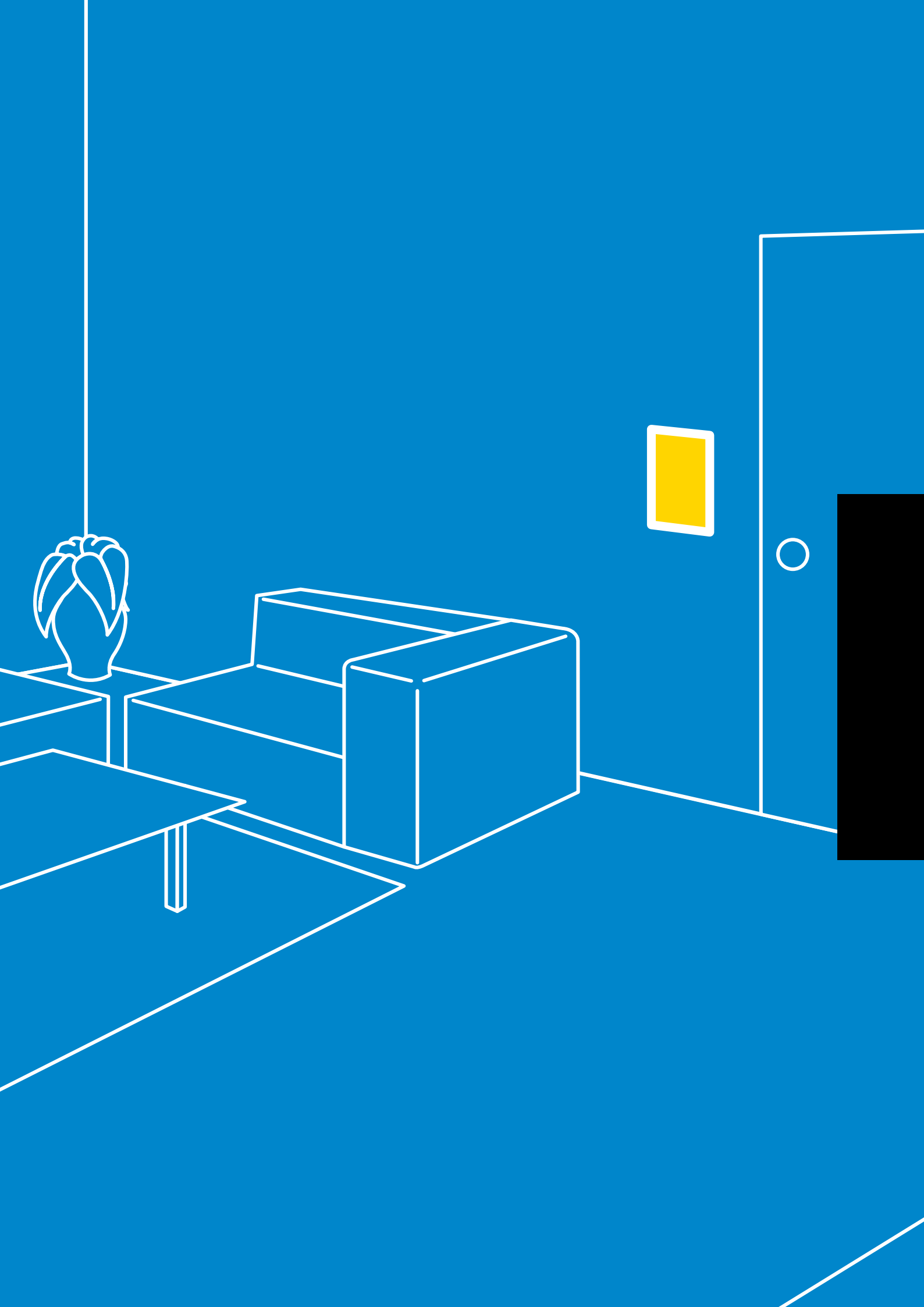

Intercoms



Electronic call	Compact	44
Electronic call	Studio	45
Electronic call	Project	46
Alternate current call	Project	47
Alternate current call	724N - 924W	48
Electronic call	Compact 1+1	49
Electronic call	Project 1+1	50
Power supplies and service modules		51
Intercom kits		52
Intercom kits		54
Interphone		55

Farfisa intercoms mean reliability combined with easy installation and use. The offer – thanks to technological evolutions – has been enlarged with the addition of integrated functions to make new communication systems even more flexible and comfortable.



Compact

(4+1)

Compact intercoms – studied with elegant and ergonomic line – are suitable to any kind of interior design. In order to supply best quality in audio service Farfisa takes full advantage of electronic call technology. Thanks to specific schematics, even intercommunication service – together with the basic intercom features - is allowed. Compact handsets are suitable to any Farfisa door station.

44

KM810W

Intercom electronic call Compact series

colour | white

w x h x d | 86 x 65 x 211

For 4+1 intercom systems, it is supplied with a button with door-lock function and a second optional one by adding the ST701.

SERVICE MODULES

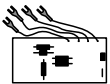

SM50E

Private conversation module for systems with electronic call. When installed inside the KM810W intercom, it allows only the called user to be put in communication with the external door station.

1471E

Three command input relay unit (12V ac; 12/24V dc and electronic note). Provided with timed output for systems with electronic call and private conversation. 4 A modules in DIN bar.

1472

2-exchange exchanger (1A, 24V) 3 command input: 12 Vdc/Vac, 24 Vdc and electronic note. Mountable on 3 A DIN module.

GN30

Generator of 3 electronic ringers. For differentiated calls from landings or various external door stations.

RL36

Relay module with one exchange (1A, 24V) to be integrated inside intercoms, it permits to drive 12 Vdc/Vac signal, electronic note and EC ground.

RL37

It can drive the chime for intercoms and videointercoms, mountable on 4 A DIN module. One free supplementary contact is available, with electronic note.



SR41

Electronic buzzer module for parallel call of various intercoms in systems with electronic call.

ACCESSORIES



ST701

Additional button for KM810W and KM811W intercom.



ST703

Three level switch for KM810W and KM811W intercoms to adjust chime volume.

POWER SUPPLIES

PRS 226E

18VA power supply-commutator with 2 electronic ringers. 8Vdc-13Vac. 6 A modules in DIN bar. For intercoms connected to external door station.

PRS240

18 VA power supply with 2 modulated electronic ringers module; 8 Vdc-13Vac. VDE certification. 6 A modules in DIN bar.

Intercoms with additional call from landing connected to 1 external door station

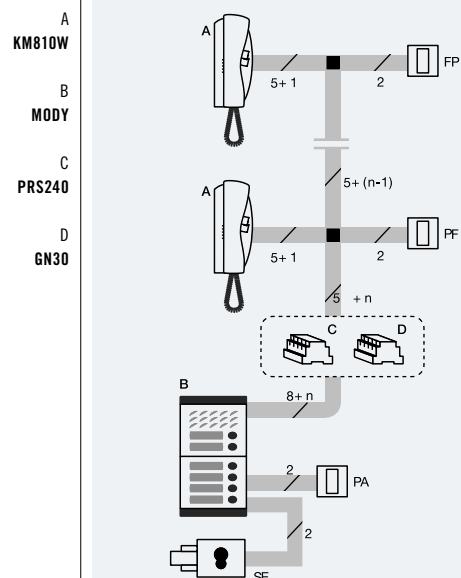



ST720W

Intercom electronic call Studio series
 colour | white
 w x h x d | 93 x 209 x 67

Intercom of Studio series in white colour and with spiral cord, door lock release button. Up to six buttons or accessories can be added enhancing the available functions. It can be used in electronic call systems, intercommunicating or digital FN4000.

SERVICE MODULES

1471E
 Three command input relay unit (12V ac; 12/24V dc and electronic). Provided with timed output for systems with electronic call and private conversation. 4 A modules in DIN bar.

1472
 2-exchange exchanger (1A, 24V) 3 command input: 12 Vdc/Vac, 24 Vdc and electronic note. Mountable on 3 A DIN module.

GN30
 Generator of 3 electronic ringers. For differentiated calls from landings or various external door stations.

RL36
 Relay module with one exchange (1A, 24V) to be integrated inside intercoms, it permits to drive 12 Vdc/Vac signal, electronic note and EC ground.

RL37
 It can drive the chime for intercoms and video intercoms, mountable on 4 A DIN module. One free supplementary contact is available, with electronic note.

SM50E
 Private conversation module for systems with electronic call. When installed inside the intercom, it allows only the called user to be put in communication with the external door station.

SR41
 Electronic buzzer module for parallel call of various intercoms in systems with electronic call.

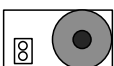
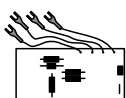

Studio

(4+1)

Farfisa offers 4+1 technology with electronic call for Studio intercom line, so that all the typical services of intercom communication are guaranteed, intercommunication function as well. The peculiarity of Studio range is the great modularity of the elements, that allows a true system integration offering new possibilities in the installation, where any Farfisa door station can be used.

POWER SUPPLIES

PRS226E
 18VA power supply-commutator with 2 electronic ringers. 8V dc-13V ac. 6 A modules in DIN bar. For intercoms connected to external door station.

PRS240
 18VA power supply with modulated electronic ringer module. 8V dc-13V ac. VDE certification. 6 A modules in DIN bar.

ACCESSORIES

ST701
 Single button unit for intercom ST720W.

ST702W
 LED module for door open or other functions indication.

ST703
 Three level switch for ST720W intercom to adjust chime volume.

ST704
 Additional loudspeaker.

ST715
 Switch module to cut out ringer or other functions.

ST716
 Switch module with LED indication for intercom ST720W. It allows according to the connection to activate or deactivate connected command.

WB700
 Wall bracket for module Studio series and intercom telephone set ST740W. For intercom ST720W when connected to the monitor module.

TA720W
 Table adapter in white colour, for ST720W single intercom. Complete with junction box and 2,4 m connection cable with 20 wires.

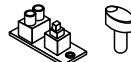



PT510EW

PT526EW

PT510EW

Intercom electronic call Project series
 colour | white
 w x h x d | 77 x 214 x 72

Basic intercom with door-opener button and spiral cord.

PT526EW

Intercom electronic call Project series
 colour | white
 w x h x d | 86 x 214 x 72

Extendable intercom, for additional or intercommunication functions, for 4+1 systems with electronic call. Complete with 2 buttons extendable up to 10 for door-opener, intercom calls and services.

SERVICE MODULES

1471E

Three command input relay unit (12V ac; 12/24V dc and electronic note). Provided with timed output for systems with electronic call and private conversation. 4 A modules in DIN bar.

1472

2-exchange exchanger (1A, 24V) 3 command input: 12 Vdc/Vac, 24 Vdc and electronic note. Mountable on 3 A DIN module.

GN30

Generator of 3 electronic ringers. For differentiated calls from landings or various external door stations.

RL36

Relay module with one exchange (1A, 24V) to be integrated inside intercoms, it permits to drive 12 Vdc/Vac signal, electronic note and EC ground.

RL37

It can drive the chime for intercoms and videointercoms, mountable on 4 A DIN module. One free supplementary contact is available, with electronic note.



SR41

Electronic buzzer module for parallel call of various intercoms in systems with electronic call.

Project

(4+1)

Project intercom range is always a good solution for any aesthetic request, because of its classic line and soft shape. Of course 4+1 electronic call technology contributes to Project intercoms reliability especially in audio quality, preventing noises on the line. Basic intercom services are guaranteed and for the extendable model, even intercommunication function is allowed. They are suitable to any Farfisa door stations.

ACCESSORIES

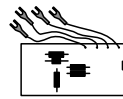

SM50E

Private conversation module for systems with electronic call. When installed inside the intercom, it allows only the called user to be put in communication with the external door station.

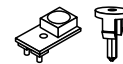

PT501

Single button unit.

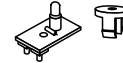

PT502

LED module for door open indication and other functions.

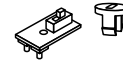

PT515

Switch module to cut out ringer (privacy) or other functions.

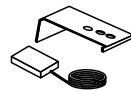

PT538

Desk adapter with weighted base, connector block and connection cable with thirteen 2.4m wires.

POWER SUPPLIES

PRS226E

18VA power supply-commutator with 2 electronic ringers. 8V dc-13V ac. 6 A modules in DIN bar. For intercoms connected to external door station.

PRS240

18VA power supply with 2 modulated electronic ringers module. 8V dc-13V ac. VDE certification. 6 A modules in DIN bar.

5 intercommunicating intercoms connected to 2 external door stations with individual calls

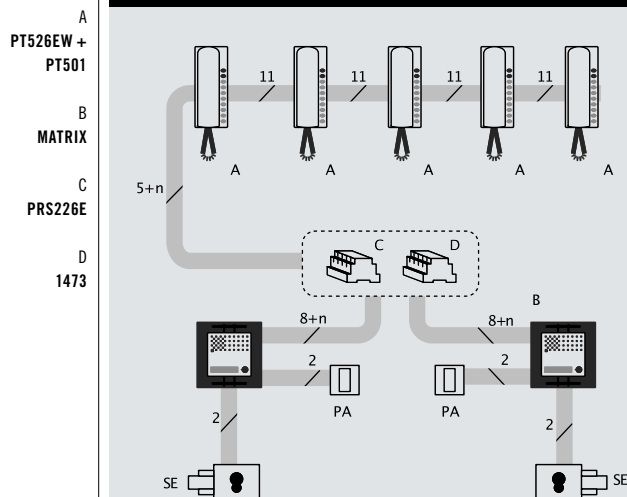



PT510W

PT510W

Intercom alternate current call Project series
colour | white
w x h x d | 77 x 214 x 72

Basic intercoms with door-opener button, spiral cord, electronic microphone, wall mounting and buzzer for 4+1 intercom systems with alternate current call. Also suitable for systems with electronic call.

PT520W

Intercom alternate current call Project series
colour | white
w x h x d | 86 x 214 x 72

Extendable intercom, for additional or intercommunication functions, for 4+1 systems with alternate current call. Compatible with 3+1 systems. Complete with electronic microphone, buzzer, spiral cord and 2 buttons extendable to 10 for door-opener, intercom calls and various services.

PT524W

Intercom alternate current call Project series
colour | white
w x h x d | 77 x 214 x 72

Basic intercom, for 4+1 systems with alternate current call. Complete with door-opener, carbon microphone, buzzer, spiral cord. It can be used also in systems with electronic call.

Project

(4+1)

Farfisa enhances its offer with Project intercom for alternate current call installations. This apparatus guarantees features for basic requirements and in case of extendable version, even additional functions are available, always with intercommunication service. Project is also the ideal device to be installed – together with specific system elements – in order to get easily and in reliable way electronic call technology. Any Farfisa door station can be used.

ACCESSORIES

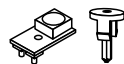

PT501
Single button unit.

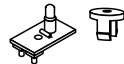

PT502
LED module for door open indication and other functions.

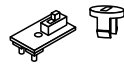

PT515
Switch module to cut out ringer (privacy) or other functions.

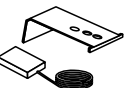

PT538
Desk adapter with weighted base, connector block and connection cable with thirteen 2.4m wires.

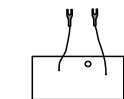

SR40
Electronic ringer module for systems with alternate current call. When installed inside the intercom, it allows the buzzer call to be replaced by the electronic call or a call to be added, e.g. a call from landing.

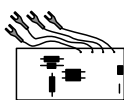

SM50
Private conversation module for systems with alternate current call. When installed inside the intercom, it allows only the called user to be put in communication with the external door station.

Multi-way intercom system with secondary door stations and one main common door station

- A PT510W
- B PT520W
- C MATRIX
- D PRS220
- E 1473

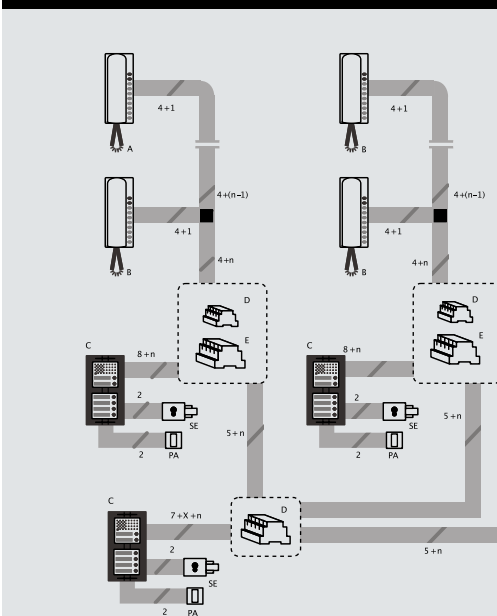

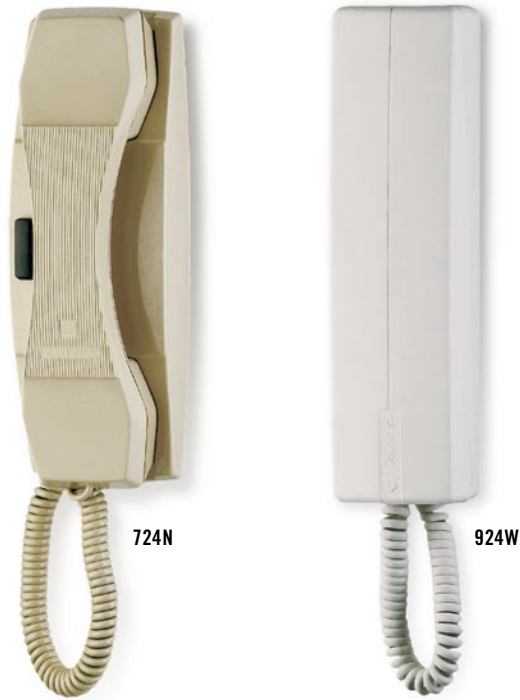

724N

924W

724N - 924W

(4+1)

Besides new Farfisa ranges, the choice of the ideal intercom is wide even for the 724N and 924W models. These apparatus take advantage of 4+1 alternate current call technology: quality, reliability and long-lasting operation life are guaranteed. Thanks to the right system components, these intercoms can also be in operation with electronic call technology. They are suitable to any Farfisa door stations.

724N

Intercom alternate current call 700 series

colour | beige

w x h x d | 75 x 215 x 88

Intercom for alternate call 4+1 systems. Complete with carbon microphone, buzzer, door opener button and spiral cord.

924W

Intercom alternate current call 900 series

colour | white

w x h x d | 60 x 225 x 48

Intercom with essential line and compact dimensions it is suitable with 4+1 alternate call systems. Complete with electronic microphone, buzzer, door opener button and spiral cord.



KM811W

KM811W

Intercom 1+1 electronic call Compact series
 colour | white
 wxhxd | 86 x 65 x 211

For 1+1 intercom systems, complete with a push button for door-lock function and a second optional one adding the ST701.

ACCESSORIES



ST701
 Additional push button for KM810W and KM811W intcoms.



ST703
 Three level switch for KM810W and KM811W intercoms to adjust chime volume.

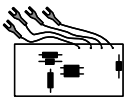

SM50
 Private conversation module for 1+1 systems with electronic call. When installed inside the KM811W intercom, it allows only the called user to be put in communication with the external door station.

SERVICE MODULE

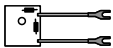

241D
 2 diode module to be inserted in button modules MD21, MD22, MD23, MD24, MD222, MD224, MD226, MD228.

241DMA
 4 diode module to be inserted in button modules PL21, PL22, PL23, and PL24.

POWER SUPPLY

PRS210ED
 15VA transformer with electronic ringer for 1+1 audio installations. 127-230V. 13Vac. 4 A modules in DIN bar.

Compact 1+1

(1+1)

These Compact intercoms are conceived for 1+1 wire technology (one common wire for all the intercoms of the installation plus one for each apparatus) with electronic call for the best quality in audio service and to reduce line noises. All the traditional services for intercom communication are guaranteed and they are suitable for installations with Farfisa door stations as Profilo and Mody range.

Multi-way intercom system with secondary door stations and one main common door station, system 1+1

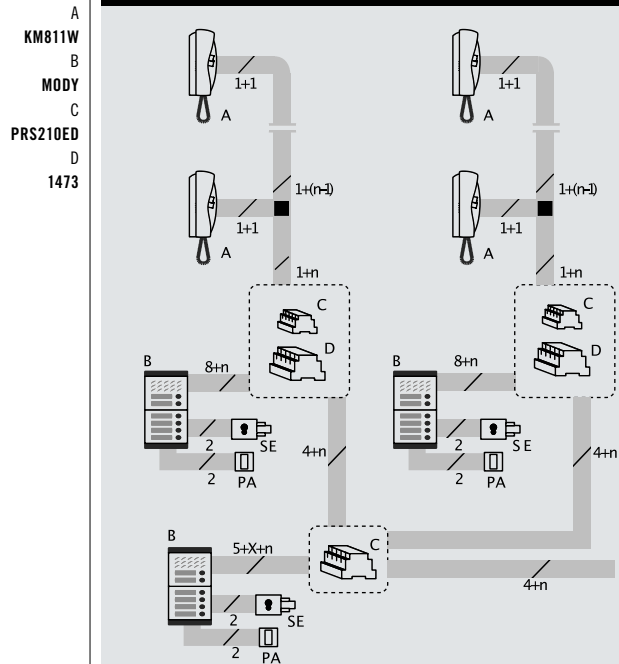



PT511EW

PT511EW

Intercom 1+1 electronic call Project series

colour | white

w x h x d | 77 x 214 x 72

Intercom complete with door-opener button, spiral cord and microphone. Possibility of incorporating the private conversation module.

ACCESSORIES

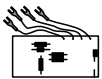

SM50

Private conversation module.



PT538

Desk adapter with weighted base, connector block and connection cable with thirteen 2.4m wires

MODULES



241D

2 diode module to be inserted in button modules MD21, MD22, MD23, MD24, MD222, MD224, MD226, MD228.

241DMA

4 diode module to be inserted in button modules PL22, PL23, and PL24.

TRANSFORMER

PRS210ED

15VA transformer. 127-230V. 13V ac. 4 A modules in DIN bar.



Project 1+1

(1+1)

Project versatile range offers also 1+1 wire technology intercom for installations with electronic call where a single wire is common for all the system and another wire is planned for each intercom, therefore high quality for audio transmission is available. This model satisfies all the typical intercom requirements and can work with Farfisa door stations as Profilo and Mody series.

Intercoms connected to 1 external door station, 1+1 system

A
PT511EW
B
MODY
C
PRS210ED

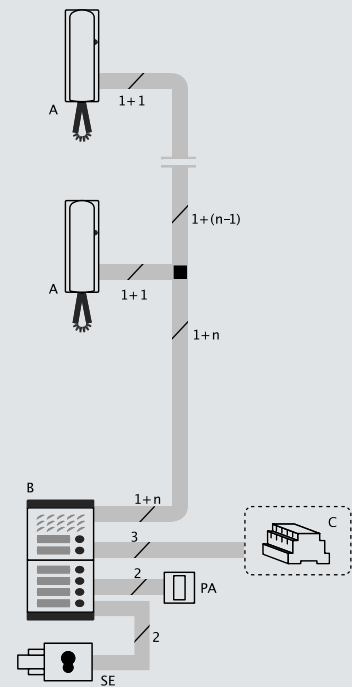



POWER SUPPLIES AND SERVICE MODULES

SERVICE MODULES



303

Low absorption supplementary buzzer (12V ac-150mA) with container. It can be used for alternate current systems and when it is required to drive a chime. Mountable on 83 mm lighting flush box.

1473

4-exchange switcher for automatic switching of 2 inputs. 8 A modules in DIN bar. Used in 4+1 (traditional or electronic call), 1+1 intercom systems or intercommunication systems.

1471

Two command input relay unit (12V ac; 12/24V dc). 3 A modules in DIN bar.

1471E

Three command input relay unit (12V ac; 12/24V dc and electronic). Provided with timed output for systems with electronic call and private conversation. 4 A modules in DIN bar.

1472

2-exchange exchanger (1A, 24V) 3 command input: 12 Vdc/Vac, 24 Vdc and electronic note. Mountable on 3 A DIN module.

GN30

Generator of 3 electronic ringers. For differentiated calls from landings or various external door stations.

936

Buzzer module.

RL36

Relay module with one exchange (1A, 24V) to be integrated inside intercoms, it permits to drive 12 Vdc/Vac signal, electronic note and EC ground.

RL37

It can drive the chime for intercoms and video intercoms, mountable on 4 A DIN module. One free supplementary contact is available, with electronic note.

CV02

Placed inside the external door station, it sounds in case of effected chime.

Power supplies and service modules

For its intercom solutions Farfisa offers stabilised power supplies for mounting on DIN bar, conceived for different kinds of installation. Mains supply at 230V and 127V. Protected against overloading or overvoltage by thermoprotectors. All the power supplies comply with the European safety standard EN60065.

Service modules -properly combined to intercom or accessories- allow new possibilities and performances.

POWER SUPPLY

PRS210

Stabilised power supplies for assembly on DIN bar. Mains supply at 230V and 127V. Protected against overloading or overvoltage by thermoprotectors. All the power supplies comply with the European safety standard EN 60065.

POWER SUPPLIES FOR SYSTEMS WITH ELECTRONIC CALL

PRS240

18VA power supply with 2 modulated electronic ringers module. 8V dc-13V ac. VDE certification. 6 A modules in DIN bar. It can be used also with alternate call systems.

PRS226E

18VA power supply-commutator with 2 electronic ringers. 8V dc-13V ac. 6 A modules in DIN bar. VDE Certification. For intercoms connected to external door station.

POWER SUPPLIES FOR SYSTEMS WITH ALTERNATE CURRENT CALL

PRS220

15VA power supply. 6V dc-13V ac. VDESASO certifications. 4 A modules in DIN bar.

PRS220P

22VA Power supply. 6V dc-13V ac. 8 A modules in DIN bar.

PRS226

18VA power supply-commutator. 8V dc-13V ac. VDE certification. 6 A modules in DIN bar. For intercoms connected to external door station.

PRS231

Power supply 8V dc- 13 VAC 6 A DIN module It is able to supply intercommunicating intercom systems without door station.

PRS235

18VA power supply with call reset. 8V dc- 13V ac. VDE certification. 6 A modules in DIN bar. For private conversation systems.

Intercom Kits

For an easy, practical and fast selection, Farfisa offers many intercom kits for one-way or two-way systems, different in technology and aesthetical design. All the solutions are ready to be installed and include intercom, door station and power supply. They are packed in carton boxes or plastic bags.



KIT 2PTMW



KIT 2SEW/G

CONVENTIONAL TECHNOLOGY WITH ALTERNATE CURRENT CALL



Kit PTM

Project-Mody series with flush mounted push-button panel and integrated door speaker.

1PTMW one-way / white intercom
2PTMW two-way / white intercom



Kit MP

Project-Mody series with flush mounted push-button panel and separated door speaker.

1MPW one-way / white intercom
2MPW two-way / white intercom



Kit UP

Project-Up series with flush mounted push-button panel

1UP one-way / white intercom
2UP two-way / white intercom



Kit VICTORY

Project-ErreP/R series with flush mounted push-button panel

1V, 2V, 3V, 4V, 6V, 8V, 10V, 12V
from 1 to 12 users / white intercom



Kit UPS

Project-Up series with surface push-button panel

1UPS one-way / white intercom
2UPS two-way / white intercom



Kit SEW/G

900-ErreP/R series with surface mounted push-button panel

1SEW/G one-way / white intercom
2SEW/G two-way / white intercom



KIT 1STW



KIT 1MKEW



KIT 1UPSF, KIT UPSD

CONVENTIONAL TECHNOLOGY WITH ELECTRONIC CALL



Kit STW

Studio-Mody series with flush mounted push button panel

1STW one-way / white intercom



Kit 1MKEW

Compact-Mody series with flush mounted push button panel

1MKEW one-way / white intercom

REDUCED WIRE TECHNOLOGY WITH ALTERNATE CURRENT CALL



Kit UPD

Project-Up series with flush mounted push-button panel

1UPD one-way / white intercom

2UPD two-way / white intercom



Kit UPSD

Project-ErreP/R series with surface mounted push-button panel

1RPD one-way / white intercom

2RPD two-way / white intercom

2 WIRE TECHNOLOGY



Kit UPF

Project-Up series flush mounted

1UPF one-way / white intercom



Kit UPSF

Project-Up series surface mounted

1UPSF one-way / white intercom

Intercom Kits

Kit model	External door station	Intercom	Power supply	Installation system
1PTMW	MD71+MD100	PT510W	PRS210	4+1 one-way
2PTMW	MD71+MD200	2 x PT510W	PRS210	4+1 two-way
1MPW	MD71+MD11+MD30	PT510W	PRS220	4+1 one-way
2MPW	MD71+MD12+MD30	2 x PT510W	PRS220	4+1 two-way
1V÷12V	RP1 ÷ RP12+MD30	1÷12 x PT524SW	PRS220	4+1 from 1 to 12 users
1UP	UP11	PT510W	PRS210	4+1 one-way
2UP	UP12	2 x PT510W	PRS210	4+1 two-way
1UPS	UP100	PT510W	PRS210	4+1 one-way
2UPS	UP200	2 x PT510W	PRS210	4+1 two-way
1SEW/G	RP100	924W	PRS210	4+1 one-way
2SEW/G	RP200	2 x 924W	PRS210	4+1 two-way
1UPD	UP11D	PT511SW/1	PRS210	1+1 one-way
2UPD	UP12D	2 x PT511SW/1	PRS210	1+1 two-way
1UPSD	UP111	PT511SW/1	PRS210	1+1 one-way
2UPSD	UP211	2 x PT511SW/1	PRS210	1+1 two-way
1UPF	UP da incasso	PROJECT	PRS210	2 wire one-way
1UPSF	UP filo muro	PROJECT	PRS210	2 wire one-way
1STW	MD71+MD30+MD11	ST720W	PRS240	4+1 one-way
1MKEW	MD71+MD30+MD11	KM810W	PRS240	4+1 one-way

Interphone



1006

Interphone

w x h x d | 160 x 100 x 40

Wireless hand-free interphone with automatic or manual speaker switching. It allows a maximum of 3 simultaneous and independent conversations. Complete with volume adjustment, on/off switch, call button and transmission channel switch (A-B-C). It does not require installation. Input 230V.



Digital Systems



DUO System Door stations	Matrix	58
DUO System Internal stations	Compact	60
DUO System Internal stations	Project	61
FN4000		62
FN4000 Door stations	Matrix	63
FN4000 Door stations	Mody	64
FN4000 Internal stations	Compact	65
FN4000 Internal stations	Project	66
FN4000 Internal stations	Studio	67
FN4000	FN4000 system composition	68
DF6000		69
DF6000 Door stations	Mody	70
DF6000 Internal stations	Project	71

Farfisa offer for digital solutions is composed by different systems, each of them carefully and efficiently satisfies many different situations, even complex ones and with many users. Versatile and flexible systems with highest technology that guarantee integration of new performances and functions to videointercom installations. Further implementations and opportunities are now developed by Aci Farfisa, especially based on Duo System and on FN4000 platform.

DUO system

Duo System stands for the most modern philosophy of Aci Farfisa digital system, for a practical and fast videointercom installation, that allows to strongly reduce time and costs. A new technology that simplifies the videointercom systems of considerable size that evolves with technological updatings; with Duo System only 2 non-polarised wires are enough to easily make quite complex installations also. Thanks to updating and new implementations of the system, it's now possible to increase the number of users and distances. As a matter of fact today new apparatus planned for Duo System allow to reach 200 internal stations connected to different risers. Video and audio signals, door lock opening service and controls of various functions stay only on 2 non-polarised wires, improving the quality and simplifying the system and the maintenance. Wiring is easier, times of carrying out are shorter, for a great reducing in installation costs.

Matrix

Duo System technology exploits - in videointercom installations with only two wires - the elegant and innovative aesthetics of Matrix range with modules for conventional or digital push button panels. Thanks to the continuous technological evolutions of the system, today DUO allows installations extremely easy to mount, with max 8 main door stations in parallel, up to 4 risers and 3 secondary door stations for each riser. Solid and anti vandal, the modular Matrix push button panel is composed by buttons and plates in stainless steel, especially conceived to be resistant to breaking, water spout and solid penetration. The back light with green LED's allows a simple identification especially in poorly illuminated situations. Moreover its modularity allows the realisation of videointercom systems for great number of users, with also possibility of vertical or horizontal mounting configuration.

DIGITAL EXTERNAL DOOR STATIONS

TD2100MA

Digital door station
w x h | 115x115

Digital door station of Matrix series for Duo System, with stainless steel front plate and 14 buttons. Equipped with 16-digit display on 2 lines. It allows the call from the user by dialling the corresponding number and electric lock release by entering the private code. The electronic index is also integrated, which gives the possibility to scroll the names in alphabetical order and select the desired one. It contains up to 250 name users.

CONVENTIONAL EXTERNAL DOOR STATIONS



CD2132MA

Digitizer
w x h | 115x115

Digitizer for Duo System with 2 call buttons for conventional Matrix external door stations. It is contained in a single module and allows to code up to 63 users.



CD2134MA

Digitizer
w x h | 115x115

Digitizer for Duo System with 4 call buttons for conventional Matrix external door stations. It is contained in a single module and allows to code up to 63 users.

DUO system



DIGITAL VIDEOINTERCOM COMPOSITION WITH CONVENTIONAL CHIME



DIGITAL VIDEOINTERCOM COMPOSITION WITH DIGITAL CHIME

AUDIO AND CAMERA MODULES

AD2110MA
Audio module
w x h | 115x115

Matrix audio external door station for Duo System, with no call button.

MA22S
Button module
w x h | 115x115

Additional Matrix button module with 2 call buttons to be combined with CD-2132MA or CD2134MA. Encoding board for 2 buttons integrated.

MA24S
Button module
w x h | 115x115

Additional Matrix button module with 4 call buttons to be combined with CD-2132MA or CD2134MA. Encoding board for 4 buttons integrated.

VD2120MA
Audio-video module
w x h | 115x115

B/w Matrix video external door station for Duo System. Camera is equipped with fixed 3.6 mm lens.

Videointercom system with 2 entrances, of which one digital and one

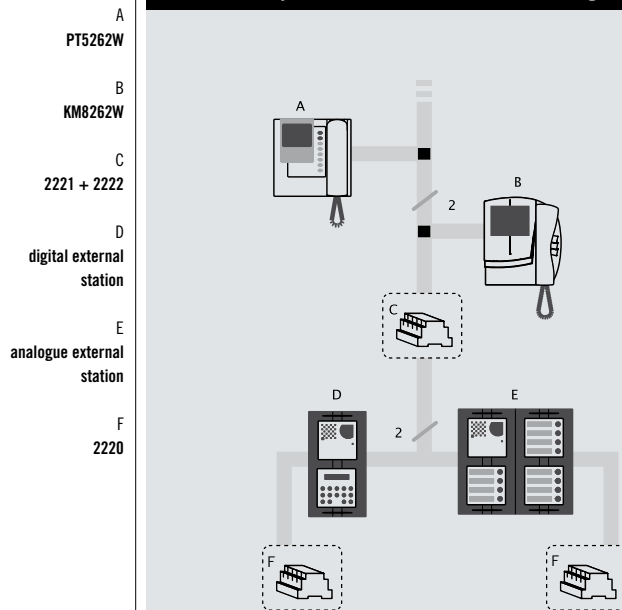

DUO system



KM8262W

KM862W

Compact

Innovative technology of DUO System allows to use Compact range for internal video stations that can reach great number of users with intercommunication service. Compact series can be chosen because of its shapes harmony that makes it suitable to many interior design with elegance and discretion.

COMPACT INTERNAL STATIONS

KM8262W

Videointercom

colour | white

w x h x d | 201x229x88

Compact videointercom for Duo System with 4" b/w Flat tube for wall surface mounting. It is equipped with three push buttons for electric lock release, auto switching and intercommunicating service. The intercommunicating call is possible between other monitors or intercoms; call from landing is allowed.

WB8262

Bracket

Wall bracket with terminal boards for electrical connections and wall mounting of KM8262W monitors.

KM862W

Intercom

colour | white

w x h x d | 86x65x211

Compact intercom for Duo System, equipped with one push button for electric lock release and a second one for intercommunicating or other service.

DUO system



PT5262W

PT562W

PROJECT INTERNAL STATIONS

PT5262W

Videointercom

colour | white

w x h x d | 215x215x89

Project videointercom for Duo System with 4" b/w Flat tube for wall surface mounting. It is equipped with two push buttons for electric lock release and auto switching and five additional buttons for programming the intercommunicating service with other monitors or intercoms or further auto switching. Another button can be for accessory functions. Call from landing is allowed.

WB5262

Bracket

Wall bracket with terminal boards for electrical connections and wall mounting of PT5262W monitors.

PT562W

Intercom

colour | white

w x h x d | 86x214x72

Project intercom for Duo System, equipped with one push button for electric lock release and six buttons for intercommunicating service and further three for accessory functions.

Project

As regards internal stations with DUO System technology, Farfisa offers the possibility of Project range with intercom and videointercom apparatus, marked by great performances and interesting opportunities for the system. Great possibilities of intercommunication service amongst intercoms and videointercoms; totally 200 internal users are guaranteed. With its classic line and flexibility that allow implementations on system functions, Project is one of the most successful range.

POWER SUPPLIES AND ACCESSORIES

DV2421P

Video line distributor for DUO System, even more flexible, that allows to realise wider installations. It is used to draw the signal from the riser to the single user.

2220

Power supply for Duo System for conventional and digital external door stations. Output 13 Vac/1A protected against overloading and short circuits. 8 DIN modules.

2221

Line power supply 40 Vac/1A. Through the riser driver, it powers the Duo System riser. 8 DIN modules. It is to use with art. 2222 riser driver.

2222

Line driver with 6 DIN modules. Properly powered through art. 2221, it allows to power the Duo System riser.

2223

Video amplifier

2273

Digital exchanger

2302

Twisted pair wire for Duo System with single section 1 mmq. 100 m coil.

DV2420

Signal distributor

FN4000



FN4000 digital intercom and videointercom system is the first ACI FARFISA solution developed on Farnet platform. This platform is made up of a combination of specifications both physical and software. Based on this, integrated and flexible systems are developed into digital technology in order to make services for flats and houses.

FN4000 system is an alternative solution to the conventional analogue system, even for a few users, with various advantages:

- *5 wires are enough for intercom systems and 5 wires (plus the coaxial cable or balanced line for Studio series) for video intercom system, regardless of the number of internal stations connected (potentially over 900)*
 - *private audio and audio-video function and electronic call are incorporated*
 - *wiring diagram is simple, regardless of the number of parallel door stations, the number of floors and the number of internal stations*
 - *reliability and ease of maintenance are very high, with very few wires and autodiagnosics for all the digital modules*
 - *external standard digital push-button panel has all the attractions of modern technology (compactness, user privacy, electronic index), but a traditional push-button panel (by adding a decode module) can be used, as well*
- For the most complete applications, a digital door-keeper exchanger is available: many functions for those who need advanced services.*

Other system features are:

- *4 digit internal station code*
- *direct internal station call dialling proper number on keypad or sequential search with electronic index*
- *door-open function with personal code*

- *use of conventional intercoms and video intercoms or with incorporated decoder*
- *the digital door station, the electronic index can be according to Mody line in aluminium or Matrix series in stainless steel*
- *the conventional door stations can also be in Mody or Matrix line. Flexibility of these two lines guarantee satisfaction to the specific requirements for the camera and function modules*

BASED ON
FARNET



VIDEO INTERCOM COMPOSITION WITH DIGITAL CHIME



VIDEO INTERCOM COMPOSITION WITH CONVENTIONAL CHIME

DIGITAL DOOR STATIONS

TD4100MA

Digital door station
w x h | 115 x 115

Digital door station of Matrix series with front plate and 14 Key in stainless steel. It is equipped with 16 characters on 2 lines display. It allows the user chime by dialling the corresponding number and electric locks release by entering the private code. The electronic index is also integrated. Scrolling function allows to display the tenant names in alphabetical sequence and the call is activated pressing the chime button. It contains up 250 name users.

Matrix

Amongst Farfisa door stations series, Matrix range for FN4000 is the most prescribed when more strength on the push button panel against breaking, water spout and solid penetration is required. Modular Matrix series is marked by a combination of elegance and strong line, that offers digital or conventional audio or video elements.

MATRIX CONVENTIONAL EXTERNAL DOOR STATIONS

CD4130MA

Digitizer
w x h | 115 x 115

Digitizer for conventional push button panels, it is contained in a Matrix single module and allows for coding up to 63 users.

Kit 4244

Button interface

Button interface, kit of 4 groups of 4 codes each. To be installed on Matrix button modules. The interface outputs are connected to the CD4130MA

AUDIO AND CAMERA MODULES

In case of traditional door station, any buttons modules of Matrix line can be used rightly integrated, by the digitizer CD4130MA and interface Kit 4244. For wall mounting any back box MA7.. series and front frames MA6.. and rain shelters MA9.. can be used.

MA10P

Audio module with door speaker, without call button
w x h | 115 x 115

MA11P

Audio module with door speaker, with 1 call button
w x h | 115 x 115

MA12P

Audio module with door speaker, with 2 call buttons
w x h | 115 x 115

MA42DG

B/w camera module 3.6mm fixed lens, with door speaker
w x h | 115 x 115

MA42CDG

Colour camera module 3.6mm fixed lens, with door speaker
w x h | 115 x 115

MA43DG

B/w camera module 3.6mm fixed lens, with door speaker, with 1 call button
w x h | 115 x 115

MA43CDG

Colour camera module 3.6mm fixed lens, with 1 call button, with door speaker
w x h | 115 x 115

BASED ON
FARNET



VIDEO INTERCOM COMPOSITION WITH DIGITAL CHIME



VIDEO INTERCOM COMPOSITION WITH CONVENTIONAL CHIME

DIGITAL DOOR STATION

Designed to be integrated in the external door station of the MODY push-button panel line, of which they use frames, back boxes, rain shelters and hood covers.

TD4100

Push-button panel

w x h x d | 124 x 180 x 18 (dimensions as 2 Mody modules)

Digital push-button panel with anodised aluminium front panel, 12-button keypad and 4-digit display. It allows the internal station to be called by entering the corresponding number and door-opening with a private code.

RD4120

Electronic index

w x h x d | 124 x 90 x 18

Electronic index, equipped with backlit 32-character LCD display, this allows the internal station list to be consulted in sequence by using only two buttons (forward and backward) in standard or fast mode. It contains up to 200 names. Complete with the call button of the selected internal station and always installed together with the TD4100 module.

TD4110

Name plate panel

w x h x d | 124 x 90 x 18

Name plate panel, it shows the identification data of the internal stations to associate them with the numbers with which they were coded. It can contain 12 names and it is backlit.

Mody

For FN4000 digital systems Farfisa offers also Mody, the range of door stations known for its curved lines with modern and nice design. In FN4000 technology Mody shows digital or conventional audio and video modules; also two-row elements are possible, in order to optimise the available space.

CONVENTIONAL DOOR STATIONS

CD4130

Digitizer

w x h x d | 124 x 90 x 18

Digitizer for conventional push button panels, it is contained in a Mody single module and allows for coding up to 63 users.

KIT4244

Button interface

Button interface, kit of 4 groups of 4 codes each. To be installed on Mody button modules. The interface outputs are connected to the CD4130 digitizer with a flat cable.

MODY CONVENTIONAL DOOR STATIONS

For details, see the chapter "Door stations", Mody series.

SPEAKER AND CAMERA UNIT MODULES

MD30: Speaker unit to be mounted on Mody series

MD10: Electric door speaker module

MD41DG: B/W camera unit module

MD41CDG: Colour camera unit module

BUTTON MODULES

All the Mody standard modules can be used with traditional external door stations properly integrated by digitizer CD4130 and kit 4244.

BASED ON
FARNET



KM8100WDG

Compact

Amongst the main novelties Farfisa offers Compact series for internal stations in FN4000 digital system. Directly a videointercom – conceived using the successful line with elegant and compact aesthetics – designed with integrated decode module, so no additional external decode module is required.

4235 multiple decoder can appropriately combined with KM810W intercom.

KM8100WDG

Videointercom

colour | white

w x h x d | 201 x 229 x 88

B/w videointercom with flat cable, 4" screen, white colour. With integrated decode module, audio-video secrecy, electronic microphone. Supplied with three buttons for door opener, camera recall and supplementary service. It allows differentiated chime sounds for calls from door station and from front door.

WB8100DG

Bracket

Wall bracket with terminal boards for electrical connections and wall mounting of KM8100WDG videointercom.

Videointercom system with 1 entrance and videointercom with integrated decode module

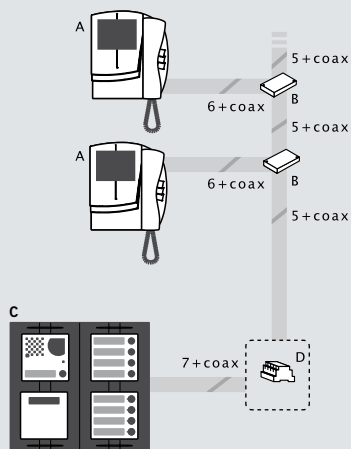

A
KM8100DG
WB8100DG

B
DV

C
CD4130MA
2XMA24
MA42DG
4244MA

D
4220

BASED ON
FARNET



PT5160W
PT5160WDG

PT510WDG
PT510W
PT510EW

PT5160WDG

Videointercom

colour | white
w x h x d | 215 x 215 x 89

B/w flat videointercom with 4" screen, white colour, with integrated decoding, audio-video privacy electronic microphone, it is complete with 2 buttons for door lock release and auto display turn-on

PT510WDG

Intercom

colour | white
w x h x d | 77 x 214 x 72

Intercom supplied with door lock release button with integrated decoding. It guarantees basic functions.

PT5160WDG-LCD

Videointercom

screen | colour
colour | white
w x h x d | 215 x 215 x 89

LCD flat videointercom with 4" screen, white colour, with integrated decoding, audio-video privacy electronic microphone, it is complete with 2 buttons for door lock release and auto display turn-on

Project

Project, classic aesthetic line, offers for FN4000 technology video or audio internal stations, that can be with or without integrated decode.

As regards videointercom solutions with integrated decode, Project offers colour PT5160WDG-LCD and b/w PT5160WDG modules, both require WB5160DG wall bracket.

Monitors without integrated decoder can be Project series with corresponding wall bracket (please see Videointercom chapter) that require 4235TV or 4235TVP multiple decodes.

For what concerns intercom apparatus with integrated decode, Project offers PT510WDG model, with one button. This intercom requires a simple connection on the riser of FN4000 system, so that basic functions for single decoder are guaranteed.

In case intercoms without integrated decode Project series is required, it is enough to add to PT510W, PT520W, PT510EW or PT526EW the multiple decode 4235 or the single decode 4231TP. Multiple decode 4235 can be joint to 924W intercom too.

INTERCOM DECODE MODULES

The decode modules interface the Speaker, Signal and Control signals between the FN4000 system and the internal stations. Each module can be shared by the number of internal stations indicated for every model.

4231TP

Single intercom decoder to be installed inside the intercom (only Project series).

4230

One-way module for intercommunicating and secondary call. Assembled in container like 8 A DIN module.

4235

Decoder for 4 intercoms. Dimensions: 135 x 159

4236

Back box for articles 4235, 4235TV, 4235TVP and 4273.

4237

External housing for articles 4235, 4235TV, 4235TVP and 4273.

BASED ON
FARNET



ST7100W + ST720W

ST720W

Studio

Studio range – modular and with modern design – offers for FN4000 digital system audio or video internal stations with or without integrated decode.

As regards videointercom installation with integrated decoder, internal stations will be composed by videointercom and intercom of Studio line (please see Videointercom chapter), joint to the specific WB7100DG wall bracket and with ST4231 integrated decode, so that no external decode is required. Anyway Studio allows to use videointercom and intercom – together with WB7100DG wall bracket – with multiple decode 4235TV or 4235TVP. For intercom solutions Studio allows to use ST720W intercom together with multiple decode 4235 or single ST4231.

VIDEO INTERCOM AND INTERCOM DECODE MODULES

The decode modules interface the Speaker, Signal and Control signals between the FN4000 system and the internal stations (intercom and video intercom). Each module can be shared by the number of internal stations indicated for every model.

ST4231

Single intercom and videointercom to be mounted inside ST720W intercom.
Dim: 135 x 159.

4230

One-way module for intercommunicating and secondary call. Assembled in container like 8 A DIN module.

4235

Decoder for 4 intercoms, Dimensions: 135 x 159.

4236

Back box for articles 4235, 4235TV, 4235TVP and 4273P.

4237

External housing for articles 4235, 4235TV, 4235TVP and 4273P.

Videointercom system with secondary video entrances, one main common video entrance and videointercoms with integrated decode module (risers of buildings)

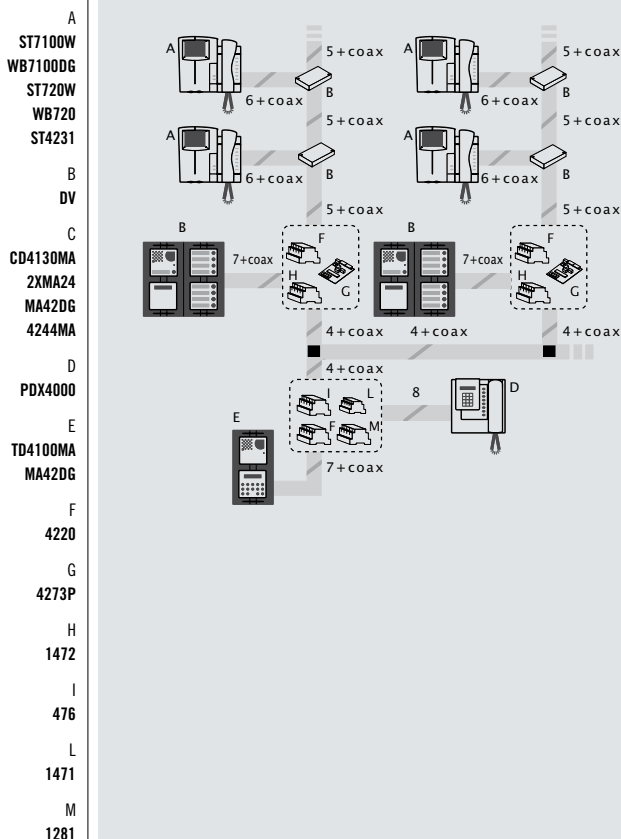

BASED ON
FARNET



PDX4000

PDX4000

Digital door-keeper exchanger
w x h x d | 215 x 215 x 89

Digital door-keeper exchanger. Available functions: call booking, call queuing, internal station-internal station and external station-internal station communication, door-open, automatic switch-on, day/night/night shunted switching.

FN4000 system composition

SERVICE MODULES OF THE SYSTEM

4273P

Digital exchanger, 4 switching exchanges for systems with secondary door stations and 1 or more main common door stations. Base: 84 x 120 mm.

1472

Exchange exchanger (1A, 24V) 3 command input: 12 Vdc/Vac, 24 Vdc and electronic note. Mountable on 3 A DIN module.

POWER SUPPLIES

PRS4220

Stabilised power supply, 230V/127V. 60VA. 12V dc/13V ac. Outputs protected against overloading and short circuits, 8 DIN modules.

PRS3220K

Stabilised reinforced power supply, 230V /127V. 100VA. 12Vdc/13Vac. Outputs protected against overloading and short circuits. Dimensions: 180 x 160 x 110.

Intercom system with secondary entrances, one main entrance and intercoms with integrated decode module and/or floor decode module (risers of buildings)

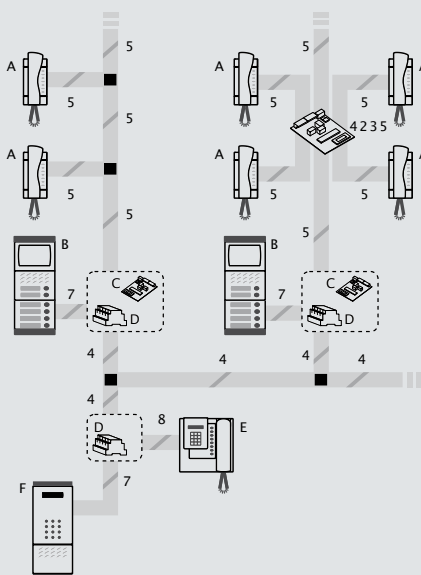

- A
ST720
ST4231
- B
CD4130
MD10÷12
MD30
MD21÷228
- C
4273
- D
4220
- E
PDX4000
- F
TD4100
MD30
MD10÷12

DF6000

DF6000 digital system basic features are flexibility of solutions and easiness of installations, thanks to a riser with only two wires for intercom applications, plus three in videointercom situations. DF6000 technology allows simplicity in the mounting and also reduction of costs, with the typical functions of a digital system.

DF6000 characteristics are:

- *only two wires or max five in video systems*
- *up to 8 entrances in parallel*
- *digital modules for external door stations (with door open by access code) or conventional modules with digitizer.*
- *Mody aesthetical line for external door stations*
- *Two possibilities for basic installation: "extended" (up to 255 internal stations) and "plus" (up to 110 users with call service from landing, bell exclusion and volume adjustment). Both modes can be partially mixed*

Multi-way videointercom system with 1 entrance

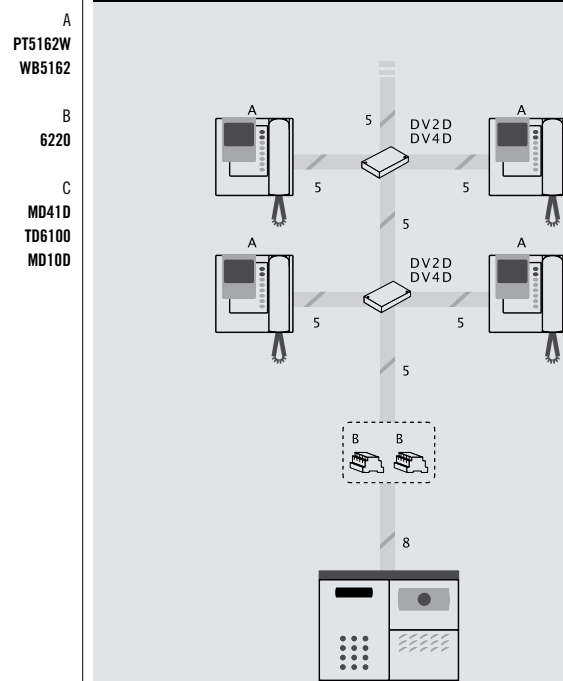



VIDEO INTERCOM COMPOSITION WITH DIGITAL CHIME

Mody



VIDEO INTERCOM COMPOSITION WITH CONVENTIONAL CHIME

DIGITAL DOOR STATIONS

Modules from Mody range – specifically conceived for digital technology - can be used. As components of these push button panels the same elements of Mody line, as back boxes, rain shelters and hood covers are available

TD6100

Push-button panel

124 x 180 x 18 (dimensions as 2 Mody modules)

Digital push-button panel with anodised aluminium front panel, 12-button keypad and 4-digit display. It allows the internal station to be called by entering the corresponding number and door-opening with a private code.

RD4120

Electronic index

124 x 90 x 18

Electronic index, equipped with backlit 32-character LCD display, this allows the internal station list to be consulted in sequence by using only two buttons (forward and backward) in standard or fast mode. It contains up to 200 names. Complete with the call button of the selected internal station and always installed together with the TD6100 module.

TD4110

Name plate panel

124 x 90 x 18

Name plate panel, it shows the identification data of the internal stations to associate them with the numbers with which they were coded. It can contain 12 names and it is backlit.

CONVENTIONAL EXTERNAL DOOR STATIONS

DF6000 allows installation of compositions of external door stations with conventional Mody line as well. As regards the main video or audio modules, respectively MD41D b/w camera and MD10D, MD11D, MD12D -different for the number of call buttons- that can be all joint to additional components, even with two-rows.

CD6130

Digitizer

124 x 90 x 18

Digitizer for conventional push button pannels, it is contained in a Mody single module and allows for coding up to 128 users.

KIT4244

Button interface

Button interface, kit of 4 groups of 4 codes each. To be installed on button modules. The interface outputs are connected with a flat cable.

POWER SUPPLY

PRS6220

Power supply, 230V/127V. 45VA. 15Vdc/13Vac. Outputs protected against overloading and short circuits, 8 DIN modules.

SERVICE MODULES

6273

Digital exchanger for DF6000 system, it can be used in installation with secondary entrances or several common main entrances.

MD41D

B/W CCD camera module for DF6000 and 4+1 video system. With 6 infrared LED's, autoiris and 3.6 mm. fixed lens. Manually adjustable. Balanced video signal output.





PT5162W



PT512W

Project

DF6000 digital system uses Project range for internal stations, for intercom and videointercom installations. Classic and careful design is always suitable for different kinds of interior environments. Meanwhile it offers the possibility of performance implementations.

INTERNAL STATIONS

PT5162W

Videointercom

colour | white

w x h x d | 215 x 215 x 89

Dedicated Flat video intercom in white colour with integrated decode module and jumper address selection. Requires the WB5162 wall bracket.

PT512W

Intercom

colour | white

w x h x d | 77 x 214 x 72

Dedicated intercom in white colour with integrated decode module and jumper address selection. Call from landing by means of SR41

PT522W

Intercom plus

colour | white

w x h x d | 86 x 214 x 72

Plus intercom. Dedicated intercom in white colour with integrated decode module, jumper address selection, electronic buzzer for call from landing, cut-out switch of ringer and ringer volume adjustment.

Videointercom system with secondary entrances and one main common video entrance (risers of buildings).

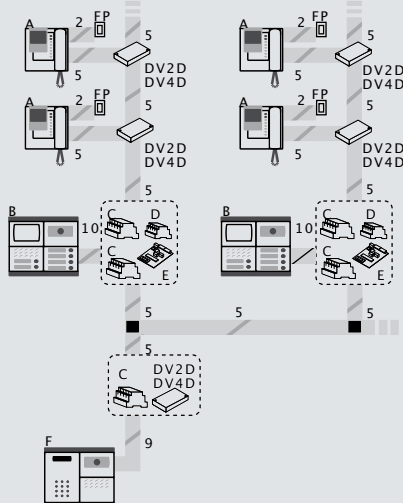

Intercom system with 1 or more entrances

- A
PT5162W
WB5162
- B
MD41D
CD6130
MD10D÷12D
MD21÷228
4244
- C
6220
- D
1472
- E
6273
- F
MD41D
TD6100
MD10D

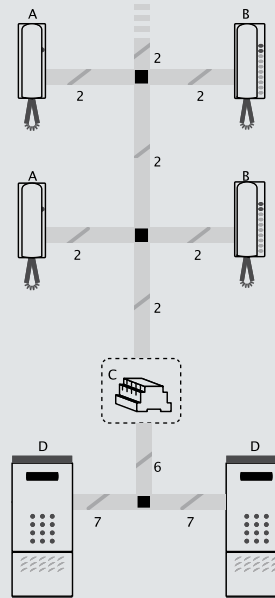

- A
PT512W
- B
PT522W
- C
PRS6220
- D
TD6100
MD10D÷12D

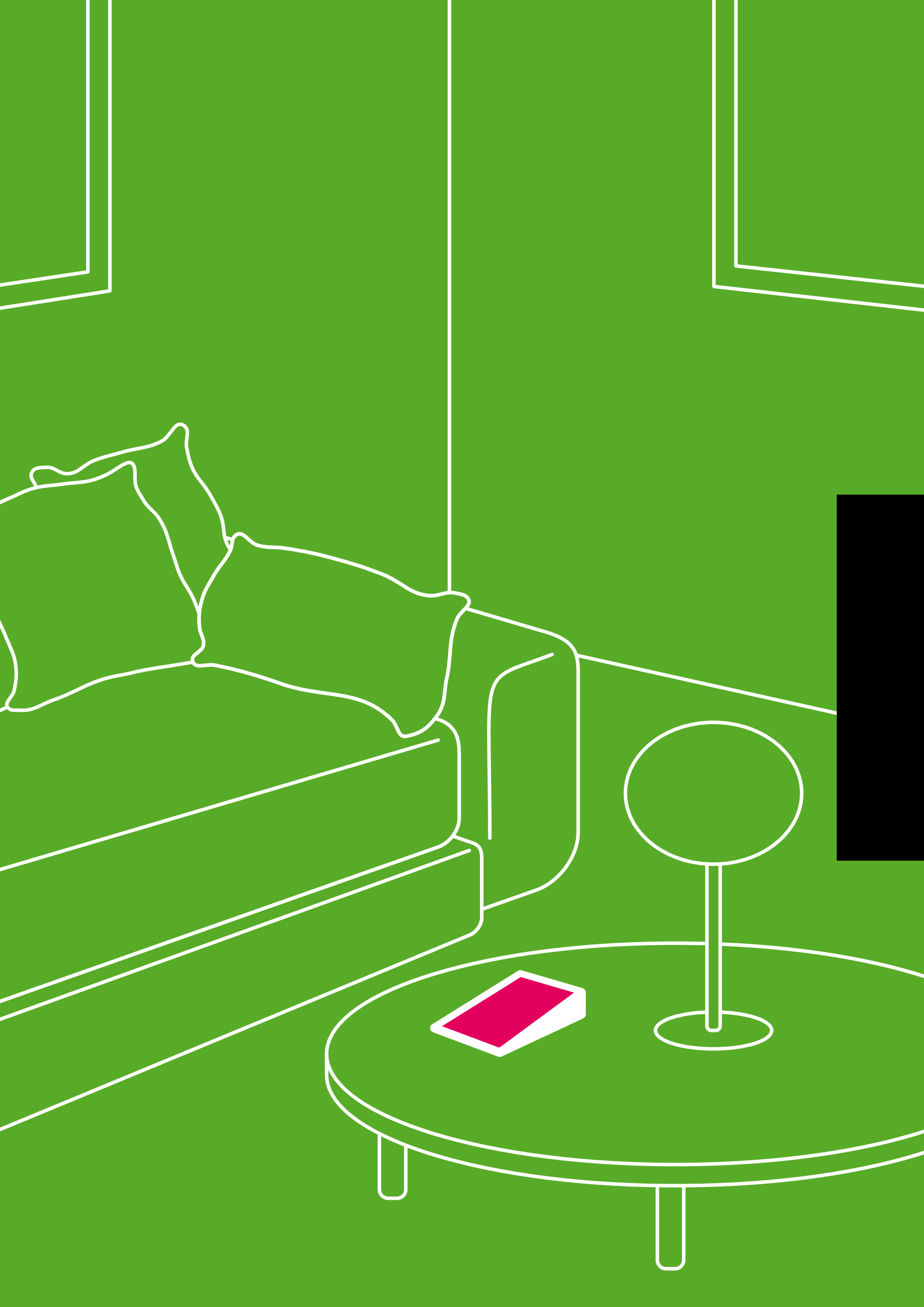

Telecommunication



Integrated communication system Fartel	74
Video and intercom telephone set Studio	76
Video and intercom telephone set Telephone interface and protections	77

The integration of traditional intercoms with telecommunication is the result of the developments of FARFISA research. Intercom telephone set with unique design, careful finishes and innovative for the integration with video and intercom functions is the latest achievement in the telephone sector that benefits from advanced technologies and updated functions.

Fartel

The FARTEL PABX's represent the heart of Aci Farfisa integrated communication. They increase the uses and capabilities of the telephone: the ideal answer to the ever-increasing communication needs of the home and the office. Suitable for all types of telephones, the FARTEL PABX perform at best when combined with the especially designed FARTEL terminals, to integrate telephone communication by telephone, intercom and intercommunication systems.

The range includes:

- FT208P PABX-2 external lines and 8 internal lines and FT105P PABX-1 external line and 5 internal lines
- ES60 or ES65 board-intercom interfaces + relay for installation in PABX's
- ES70: Caller identifier board.

The PABX's allow for setting the status of the connected terminals: programming the telephones in different telephone and intercom operating modes (e.g.: only internal, only local, only certain local areas, only some telecommunication operators), setting distinctive ringing, associating a direct internal number with each telephone set (DISA function), defining a terminal as "fax", follow me, call capture, 3-party conference. Two different general modes can be programmed (e.g.: day and night). Programming is carried out from a master telephone via a security code.



FT105P, FT208P

ELECTRONIC PABX's

Other features electrical power failure running (each external line is guaranteed a direct connection with an internal station and a permanent memory keeps the programming data), room monitor (continuous listening from one room to another), amplified speaker output for paging application, activation of electrical equipment from remote telephone.

FT105P

Electronic PABX

Telephone PABX with 1 trunk line and 5 internal lines.

FT208P

Electronic PABX

Telephone PABX with 2 external lines/8 internal lines, respectively. The intercom double call, together with the possibility to divide the external lines onto two different bands of internal stations, make the FT208 mode the ideal solution for two-way or home/office applications in which the PABX is shared.

FT105P

FT208P

Power supply	230V	230V
Maximum power consumption	16W	18W
Power consumption in stand-by	10W	10W
Temperature and humidity	0° ±40° C - 85%RH	0° ±40°C- 85%RH
Dimensions	226 x 254 x 66	226 x 254 x 66
Weight	1,3 kg	1,4 kg
No. of external lines	1	2
No. of internal lines	5	8
Italian approval	1998BXSP191	1998BXSP032

Additional boards

ES60

Intercom interface with double call and 2 relays for door-opener.

ES65

Same as ES60, with two additional relays for the activation of electrical equipment, also from remote telephone.

ES70

Board which allows to identify the calling number providing that this service is required to the local telephone provider.

System example

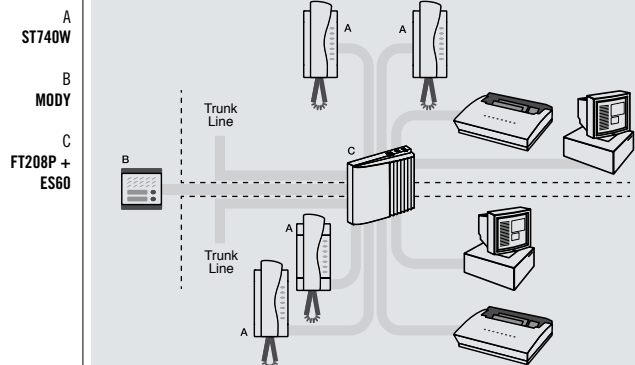



ST740W

ST7100W + ST740W

Studio

The intercom telephone set of Studio series allows the availability of the telephone services and videointercom by simply using one apparatus. By connecting it to the Fartel PABX some functions are guaranteed as communicating to the external door station, intercommunicating or activating home services. The connection to telephone line is very easy, like a standard telephone, taking fully advantage of the PABX features and services provided by the local telephone supplier.

ST740W

Intercom telephone set

colour | white colour
h x w x d | 93 x 209 x 67

It is an intercom telephone set which, when connected as internal number to a FT105P or FT208P PABX, allows the direct call to other internal numbers. When the PABX is provided with the intercom/relay board, it enables the door-opener function and the activation of electrical equipment with a single button. Designed in Studio line and in white colour, ST740W completes the Fartel FT105P and FT208P PABX's, allowing for easily-installed intercommunication systems, thus integrating all the household communication functions (telephone, intercom and intercommunication).

ST7100CW

Colour monitor module

screen | colour
colour | white colour
h x w x d | 156 x 224 x 61

Colour monitor surface mounted in white colour equipped with two buttons for door opener and control switch on. Input video signal on coaxial or balanced line. The LCD screen can be adjusted in inclination.

ST7100W

B/w monitor module

screen | b/w
colour | white
h x w x d | 156 x 224 x 61

B/w monitor, surface mounted, in white colour, it is equipped with two buttons for door opener and control switch on. Input video signal on coaxial or balanced line.

FASTENING ELEMENTS

WB700

Wall bracket for Studio modules and intercom telephone set ST740W.

WB7100

Wall bracket for monitors ST7100 and ST7100CW.

ACCESSORIES

TA700W

Table adapter in white colour for accessories Studio series, intercom and intercom-telephone set, when in composition. Complete with cable clamp, plastic and metallic frames for correct alignment with TA7100W and/or further TA700W or TA720W. To be mounted with WB700.



TA7100W

Table adapter in white colour for ST7100W and ST7100CW monitor. Complete with cable clamp, junction box and 2,4 m connection cable with 20 wires. To be mounted with WB7100.



Interface and protections

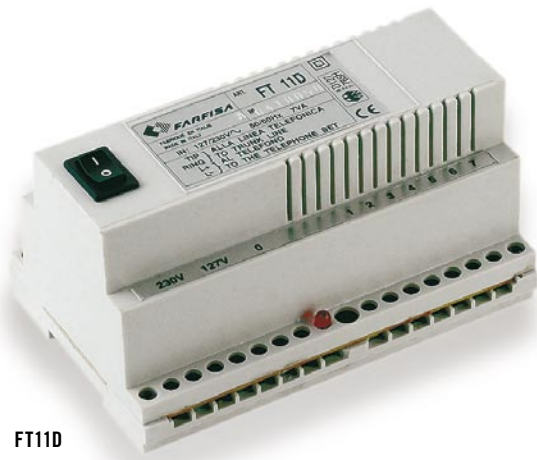

FT11D

INTERFACE

FT11D

Intercom-telephone interface

An intercom-telephone interface that allows a normal telephone to be connected to the telephone trunk line and the home intercom system. FT11D does not require any programming and telephone communication is direct. Intercom communication can take place after an external call has been received or by pressing the R key or Flash twice. Operation: during conversation, a background sound signal indicates the arrival of an intercom or telephone call to the user. The telephone conversation under way can be put on hold, with background music, in order to answer the intercom call. The intercom interface has a terminal board with the same numbering as a Farfisa intercom and can form part of a normal 4+1 intercom or traditional video intercom system.

Power supply: 127/230 Vac.
 Maximum power consumption: 7W.
 DIN housing, 8 A modules.

This model has been approved by:

- Post and Telecommunications Ministry of South Africa. Certificate n° TE-96/211
- Telecom New Zealand Ltd. Telepermit N. PTC 202/00/017

PROTECTION DEVICES

PR1

Protection

Protection device for one telephone line in DIN 2.5 module bar.

PR2

Protection

Protection device for two telephone lines in DIN 2.5 module bar.

PRAL

Protection

Protection device for power supply line in DIN 2.5 module bar.

A
 FT 11D
 B
 MODY
 C
 PRS 220

System example

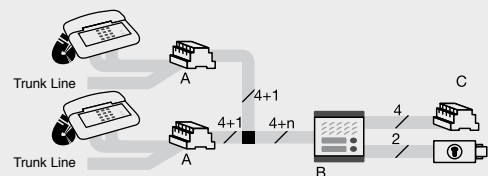

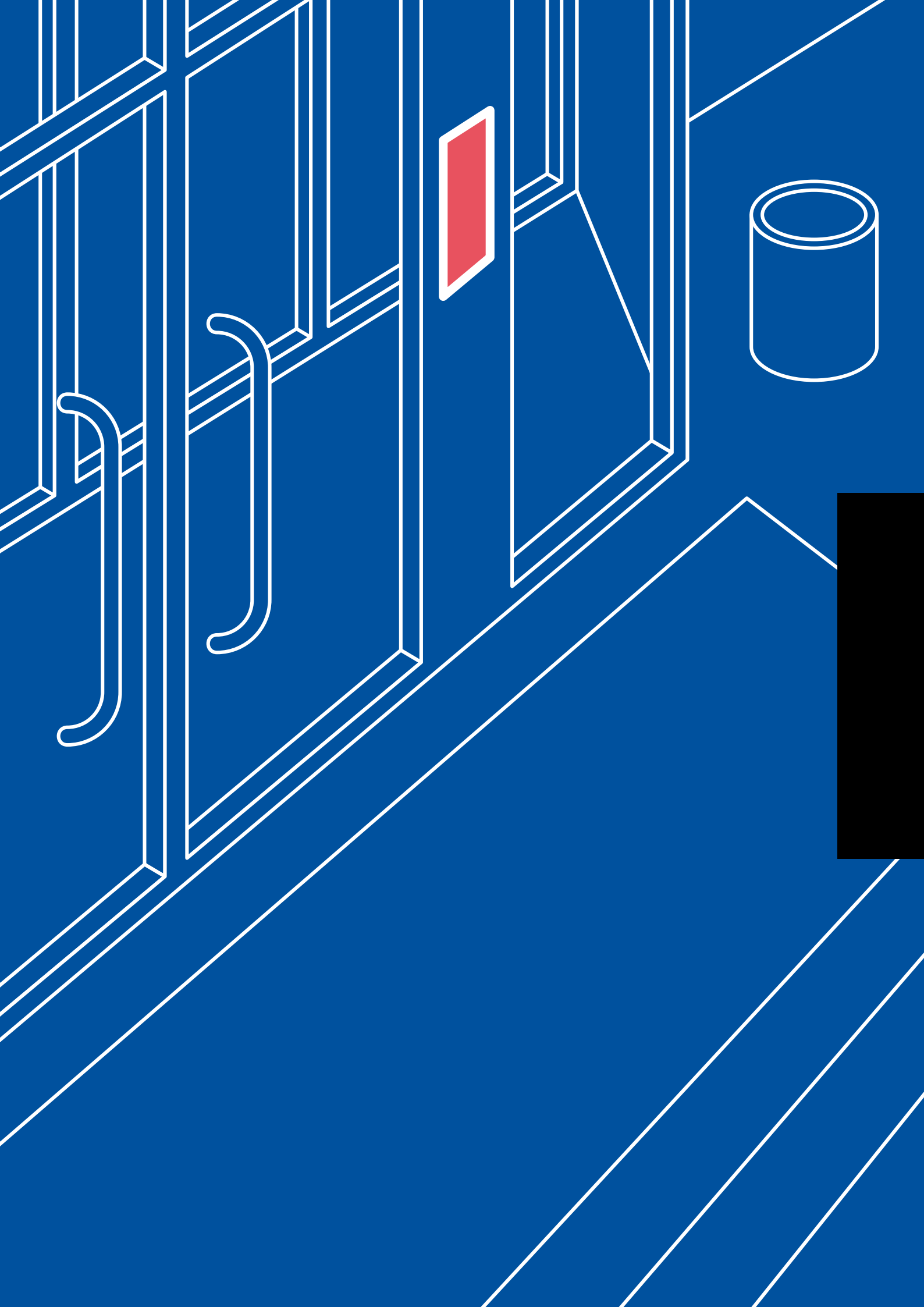

Access Control



Proximity Readers | **Farcode**

80

Keypads | **Farcode**

81

Farcode Access Control range is continuously updated with the latest technology evolutions and matches the most exigent market requests. Indeed in modern buildings it's extremely frequent to find videointercom systems combined with proximity readers or keypads, to get further security in any premises.



FP52 with MD91



FP52PL with PL71

FP52

Proximity Reader

Stand Alone Proximity Reader to be inserted in the Mody door station composition, in anodised aluminium. Ideal for access control situations, it uses all the accessories of Mody push button panels for surface or flush mounting, it is possible to combine it in Videointercom in Videointercom installations. It is provided with two mono stable relays which timing is adjustable according to the features of the connected device. The programming is made through master card managed by a display and a LED on the front of the reader that indicates also the operation status and data insertion of the enabled cards. Thanks to the 500 unit memory capacity, it is particularly indicated for the management of the access in big buildings or communities. It is provided with 4 cards + 1 Master Card. Dimensions: mm 85 x 110 x 54

FP52PL

Proximity Reader

Stand alone keypad with aluminium front plate and stainless steel buttons, that can be installed singularly or in composition with Profilo door stations for surface or flush mounting. Keypad for programming and setting relay enable codes of the two relays for door opening or access control etc.. Keypad deactivation with increasing time intervals (max 25 sec), and, in case of wrong combination, deactivation is automatic. Programmable codes from 1 to 8 digits for each relay, programmable timer from 1 to 99 sec. or bistable working of relays. Two LED's and sound signals indicate correct or wrong combination and programming. Relay can be activated by pressing additional button. Power supply 12 Vac/dc. Flush mounted version. Dimensions: cm 99x110x17

PRS210

15VA transformer. 127-230V. 13V ac.
VDE certification. 3 A modules on DIN bar.
Ideal to power with alternate current Farcode Proximity Readers and Access Control Keypads elements.

Proximity Readers

The state-of-the-art offer of Farfisa proximity reader includes elements suitable to the most versatile door station ranges, Profilo and Mody. The system is conceived to activate door or gate openings, in order to allow the exclusive access to card's or transponder's holder, once the element approaches the reader. Amongst the access control applications, its offer is especially suitable for any community's premises, residential, industrial and commercial estates.



FP11/10



FP12/10

FP11/10

Card set

Set containing 10 cards in white plastic for FP52 proximity reader. ISO standard format.

FP12/10

Transponder unit

Set composed by 10 transponder units for activation of FP52. Together with the real transponder, which is circular shaped joint to a useful metal keyholder with closing. Material is plastic in blue and white colour.



FC52PL with PL71



FC52MA with MA61



FC52P with MD91

Keypads

Aci Farfisa R&D Department is always committed to update and to implement the access control keypads range with additional and modern performances, so a relevant number of applications have been properly satisfied world wide. As a matter of fact the range is now wide and it offers several models that meet a variety of requirements. Even if stand alone they guarantee further security once combined with a videointercom system exploiting Profilo, Matrix or Mody door station combinations.

FC52PL

Access control keypad Profilo series

Aluminium stand alone proximity reader into a Profilo door station model. Designed for access control, it exploits Profilo accessories for flush or surface mounting, so even compositions for videointercom system are possible. Supplied with two relays with programmable timer according to the features of the connected device. The programming is made through a master card managed by a display and front LED's that indicate also data insertion of the enabled cards. Memory capacity is 500 cards, therefore ideal use is access control of complex buildings or communities. It is provided with 4 cards + 1 master card. Power supply 12 Vac/dc. Dimensions: cm 99x110x17

FC52MA

Access control keypad Matrix series

Anti-vandal stand alone keypad (IP45, with stainless steel front plate and buttons) that can be installed singularly or combining it with conventional or digital audio or video Matrix composition. It works with 2 relays for lock opening, access control etc. with 12 programmable codes from 1 to 8 digits for each relay. Possibility to activate relays with additional buttons (exit button). Programmable timer from 1 to 99 seconds in monostable working, or bistable operation. Flush mounting with MATRIX accessories (for the installation elements, see chapter "External Door Stations"). Power Supply: 12 Vac/dc. Dimensions in mm (w x h x d): 115 x 115 x 57

FC52P

Access control keypad Mody series

Access Control keypad with aluminium front plate and buttons in stainless steel. Two relays for lock opening, access control, etc. Keypad for programming and setting relay enable codes. Keypad deactivation with increasing time intervals (max 25 sec.) in case of wrong combination. 4 programmable codes from 2 to 6 digits for each relay. Possibility to activate relay 2 with a single button. Programmable timer from 1 to 99 seconds or bistable operation of relay 1. Two LED's and sound signals indicating correct or incorrect combination and programming.

Relay 1 can be activated by pressing an additional Exit button. Power supply 12V ac/dc. Dimensions: 124 x 90 x 54.

TRANSFORMER

PRS210

15VA transformer. 127-230V. 13V ac.
VDE certification. 3 A modules on DIN bar.
Ideal to power with alternate current Farcode Proximity Reader and Access Control Keypads elements.

Keypads

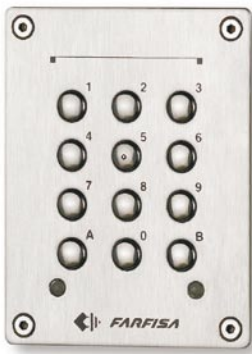

FC32P



FC42



FC21E

FC32P

Access Control keypad

Access Control keypad with aluminium front plate and buttons in stainless steel. Two relays for lock opening, access control, etc. Keypad for programming and setting relay enable codes. Keypad deactivation with increasing time intervals (max 25 sec.) in case of wrong combination. 4 programmable codes from 2 to 6 digits for each relay. Possibility to activate relay 2 with a single button. Programmable timer from 1 to 99 seconds or bistable operation of relay 1. Two LED's and sound signals indicating correct or incorrect combination and programming. Relay 1 can be activated by pressing an additional Exit button. Power supply 12V ac/dc. Dimensions: 85 x 110 x 54.

FC42

Access Control keypad

Access Control keypad IP45 surface mounted with stainless steel front plate and buttons. Two relays for lock opening, access control, etc. Keypad for programming and setting relay enable codes. Keypad deactivation with increasing time intervals (max 25 sec.) in case of wrong combination. 12 programmable codes up to 8 digits for each relay. Programmable timer from 1 to 99 seconds or bistable operation of relay 1. Two LED's and sound signals indicating correct or incorrect combination and programming. Relays can be activated by pressing an additional Exit buttons. Power supply 12V ac/dc. Dimensions: 130 x 80 x 34.

FC21E

Access Control keypad

Access control keypad with front plate, buttons and box in plastic. One lock-opening relay, access control, etc. Keypad for programming and setting relay enabling codes. Keypad deactivation with increasing time intervals (max 25 sec.) in case of wrong combination. 8 programmable codes from 2 to 6 digits. Programmable timer from 1 to 99 seconds or bistable operation. Two LED's indicating correct or incorrect combination and programming. Power supply 12V ac/dc. Wall mounted and without back box. Mountable on standard rectangular box (3-place). Dimensions: 77 x 106 x 42.

Items index

Art.	Page
1006	55
1181E	34, 35, 36
1273TV	39
1281	29, 30, 31, 32, 33, 37
1281E	30, 32
1282E	29, 30, 31, 32, 33
1304	39
1381	37
1382	39
1384	39
1443E	39
1471	51
1471E	44, 45, 46, 51
1472	39, 44, 45, 46, 51, 68
1473	39, 51
1FEV/4	41
1FEVP/4	41
1MKEW	53
1MPW	52
1PTMW	52
1SEW/G	52
1STW	53
1UP	52
1UPD	53
1UPF	53
1UPS	52
1UPSD	53
1UPSF	53
1V÷12V	52
2220	61
2221	61
2222	61
2223	61
2273	61
2302	61
241D	34, 35, 36, 49, 50
241DMA	11, 14, 34, 35, 36, 49, 50
2443	39
250/1	24
250/2	24
290/102	24
290/204	24
290/206	24
290/208	24
290/210	24
290/212	24
290/214	24
290/216	24
290/218	24
290/220	24
290/424	24
290/428	24
290/432	24
290/436	24
290/440	24

Art.	Page
290/444	24
290/448	24
290/452	24
290/460	24
290/1F	41
290R/2	22
290R/4	22
290R/6	22
290R/8	22
299/1	22
2MPW	52
2PTMW	52
2UP	52
2UPD	53
2UPS	52
2UPSD	53
2SEW/G	52
303	51
337C	22
4230	66, 67
4231TP	66
4235	66, 67
4236	66, 67
4237	66, 67
4244	63, 64, 70
4273P	68
476	39
6273	70
724N	48
9083	29
924W	48
936	51

A

AD2110MA	59
----------	----

C

CD2132MA	58
CD2134MA	58
CD4130	64
CD4130MA	63
CD6130	70
CV01	39
CV02	39, 51

D

DV2	39
DV2420	61
DV2421P	61
DV2D	34, 35, 36
DV4	39
DV4D	34, 35, 36

Art.	Page
------	------

E

EH9100CT	29
EH9100CW	29
EH9160CT	29
EH9160CW	29
EH9160PLCW	40
ES60	75
ES65	75
ES70	75

F

FC21E	82
FC32P	82
FC42	82
FC52MA	81
FC52P	19, 81
FC52PL	81
FEVS	41
FP11/10	80
FP12/10	80
FP52	80
FP52PL	80
FT105P	75
FT11D	77
FT208P	75

G

GN30	44, 45, 46, 51
------	----------------

K

KM8100CW	30
KM8100MDW	40
KM8100MDW/2	40
KM8100MXW	40
KM8100PLCW	40
KM8100PLW	40
KM8100W	32
KM8100WDG	65
KM810W	44
KM8111CW	34
KM8111MDW	41
KM8111MDW/2	41
KM8111W	35
KM811W	49
KM8262W	60
KM862W	60

M

MA10P	14, 63
MA11P	14, 63
MA12P	14, 63
MA20	14

Art.	Page
------	------

MA22	14
MA22S	59
MA24	14
MA24S	59
MA42	14
MA42C	14
MA42CDG	63
MA42DG	63
MA43	14
MA43C	14
MA43CDG	63
MA43DG	63
MA43ED	14
MA61	15
MA62	15
MA63	15
MA71	15
MA72	15
MA73	15
MA91	15
MA92	15
MA93	15
MD10	18, 64
MD100	18
MD10ED	18
MD11	18
MD11ED	18
MD12	18
MD122	18
MD124	18
MD12ED	18
MD20	19
MD200	18
MD21	19
MD22	19
MD222	19
MD224	19
MD226	19
MD228	19
MD23	19
MD24	19
MD30	19, 22, 64
MD41	18
MD41C	18
MD41CDG	64
MD41D	18, 70
MD41DG	64
MD50	19

P

P101	25
P101V	25
P102	25
P102V	25

Art.	Page
P103	25
P103V	25
P104	25
P104V	25
P106	25
P106V	25
P108	25
P208V	25
P210	25
P210V	25
P214	25
P214V	25
P218	25
P218V	25
P222	25
P222V	25
PDX4000	68
PL10P	10
PL10PED	11
PL11P	10
PL11PED	11
PL122P	11
PL124P	11
PL12P	10
PL12PED	11
PL20	11
PL21	11
PL22	11
PL226	11
PL228	11
PL23	11
PL24	11
PL40P	10
PL40PC	10
PL40PCED	10
PL41P	10
PL41PC	10
PL41PCED	10
PL422P	10
PL422PC	10
PL424P	10
PL424PC	10
PL42P	10
PL42PC	10
PL42PCED	10
PL50	11
PL71	11
PL72	11
PL73	11
PL81	11
PL82	11
PL83	11
PL84	11
PL86	11
PL89	11

Art.	Page
PL91	11
PL92	11
PL93	11
PL94	11
PL96	11
PL99	11
PR1	77
PR2	77
PRAL	77
PRS210	51, 80, 81
PRS210ED	49, 50
PRS220	51
PRS220P	51
PRS226	51
PRS226E	44, 45, 46, 51
PRS231	51
PRS235	51
PRS240	44, 45, 46, 51
PRS3220K	68
PRS4220	68
PRS6220	70
PT501	46, 47
PT502	46, 47
PT5100MDCW	40
PT5100MDW	40
PT5100MDW/2	40
PT510EW	46
PT510W	47
PT510WDG	66
PT5111EDW	41
PT5111EW	36
PT511EW	50
PT512W	71
PT515	46, 47
PT5160MDW	40
PT5160MDW-LCD	40
PT5160W	38
PT5160W-LCD	37
PT5160WDG	66
PT5160WDG-LCD	66
PT5162W	71
PT520W	47
PT522W	71
PT524W	47
PT5262W	61
PT526EW	46
PT538	46, 47, 50
PT562W	61
R	
R10	22
R12	22
R14	22
R8	22

Art.	Page
RD4120	64, 70
RL36	44, 45, 46, 51
RL37	39, 44, 45, 46, 51
RP 100	22
RP 200	22
RP1	22
RP10	22
RP12	22
RP2	22
RP4	22
RP6	22
RP8	22

S

SM50	47, 49, 50
SM50E	44, 45, 46
SMT202	25
SMT203	25
SMT204	25
SR40	47
SR41	44, 45, 46
ST4231	67
ST701	44, 45, 49
ST702W	45
ST703	44, 45, 49
ST704	45
ST7100CW	31, 76
ST7100MDCW	40
ST7100MDW	40
ST7100W	33, 76
ST715	45
ST716	45
ST720W	31, 33, 45
ST740W	76
ST7M32W	31, 33

T

T1M2	24
T2M10	24
T2M12	24
T2M14	24
T2M16	24
T2M18	24
T2M20	24
T2M4	24
T2M6	24
T2M8	24
T4M24	24
T4M28	24
T4M32	24
T4M36	24
T4M40	24
T4M44	24
T4M48	24

Art.	Page
T4M52	24
T4M60	24
TA5160	37, 38
TA700W	31, 33, 76
TA7100W	31, 33, 76
TA720W	45
TD2100MA	58
TD4100	64
TD4100MA	63
TD4110	64, 70
TD6100	70

U

UP 100	23
UP 11	23
UP 12	23
UP 200	23

V

VD2120MA	59
----------	----

W

WA9100T	29
WA9100W	29
WB5100	37, 38
WB5111E	36
WB5160	37, 38
WB5262	61
WB700	31, 33, 45, 76
WB7100	31, 33, 76
WB8100DG	65
WB8111	34, 35
WB8262	60
WB8600	30, 32

Due to the continuous technological evolution, Aci Farfisa reserves the right to change the specifications of any item without prior notice.

As for Videosurveillance sector, please refer to the specific Catalogue.

Cod: GB 01/07

Copyright © 2007:
ACI srl - www.acifarfisa.it

design:
capolinea.it

photos:
Paradisi&Borocci - Paolo Zitti

print:
Bieffe - www.bieffesrl.com



ACI srl
Via E. Vanoni, 3 - 60027
Osimo AN Italy
Tel. (+39) 071.7202038
Fax (+39) 071.7202037
www.acifarfisa.it
info@acifarfisa.it

FARFISA BELGIUM S.A.
tel. +32.2.3846455
www.farfisa.be

ACI FARFISA UK LTD.
tel. +44.1206.842800
www.acifarfisa.co.uk