

SERRATURE MECCANICHE E CILINDRI LOCK CASES AND CYLINDERS

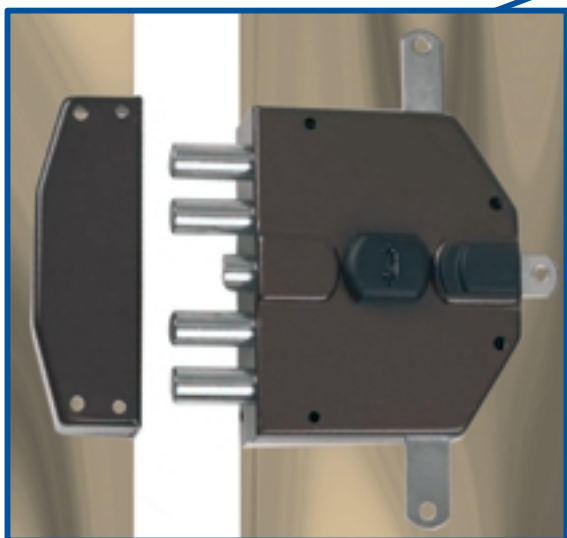

Serrature
Lock cases

**Tante chiavi aprono
tanti tipi di porte con
diversi livelli di sicurezza**



Different keys
for different security levels



INDICE

INDEX

Serrature multipunto
Multi-point locks 5



Simply

Serrature per montanti metallici
Narrow style locks 11



Control

Serrature per fasce metalliche
Midrail locks 23



Tripla

Accessori per serrature
Accessories locks 30

Serrature per porte in legno
Locks for timber doors 32



Segreta

Cilindri e chiavi
Cylinders and key 34



Serie 115-116

**CARATTERISTICHE**

3 catenacci **basculanti**

Funzioni: scrocco / rullo regolabile con catenaccio, solo catenaccio, gancio

Reversibile

Frontale piatto 24 x 3 mm o ad U 23 x 6 mm **in acciaio inox** con lunghezza fissa di 1.570 mm

Il frontale fisso evita misure e tagli supplementari nell'installazione (**praticità in officina**) e occupa minore spazio (**praticità nel magazzino**)

La multipunto è installabile prima di assemblare le varie parti della porta (**praticità in officina**)

Prolunghe **in acciaio inox** (opzionali) per un **vantaggio estetico a porta ultimata**

Interasse 85 o 92 mm

Entrate 25, 30, 35 mm

Abbinabile a tutti i tipi di cilindri (opzionali):

Serie 115-116, RK6 e Spillo

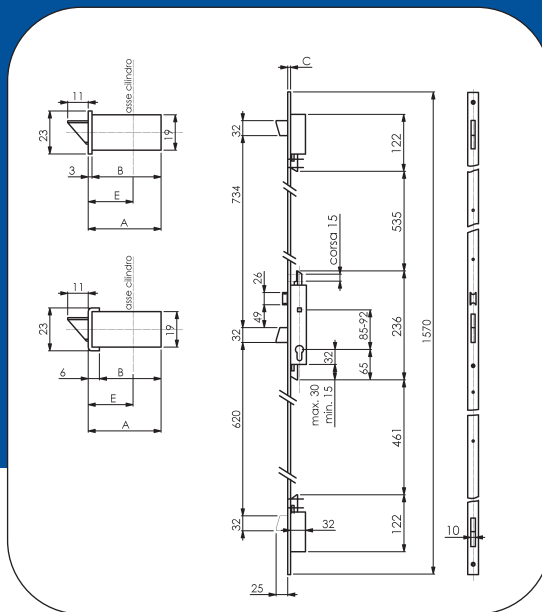
**FEATURES**

3 tilting bolts

Functions: spring latch / adjustable roller latch and dead bolt, dead bolt only, hook dead bolt

Reversible

Flat forend 24 x 3 mm or U shaped forend 23 x 6 mm, **stainless steel**, length 1.570 mm

The fixed forend avoids cuts during the installation (**convenient in workshops**) and limits number of references (**convenient in warehouses**)

Multipoint locks can be installed before assembling the door (convenient in workshops)

The stainless steel extensions (optional) **improves the door look**

Centre distance 85 or 92 mm





Backsets 25, 30, 35 mm

Cylinders to be ordered separately:

115-116 series, RK6, Cross key

4 pz.

4 pcs.

Articolo Article	Entrata Backset E	Quote Dimensions B A		Descrizione Description	Frontale Forend	Interasse Distance
7300/1	25	34	40	Scrocco + 3 catenacci Spring latch and 3 dead bolts	23x6 mm 	85
7300/2	30	39	45			
7300/3	35	44	50			
7300C/1	25	34	40	Solo 3 catenacci 3 dead bolts only		
7300C/2	30	39	45			
7300C/3	35	44	50			
7300R/1	25	34	40	Rullo + 3 catenacci Roller latch and 3 dead bolts		
7300R/2	30	39	45			
7300R/3	35	44	50			
7304/1IN	25	37	40	Scrocco + 3 catenacci Spring latch and 3 dead bolts	24x3 mm 	85
7304/2IN	30	42	45			
7304/3IN	35	47	50			
7304C/1IN	25	37	40	Solo 3 catenacci 3 dead bolts only		
7304C/2IN	30	42	45			
7304C/3IN	35	47	50			
7304R/1IN	25	37	40	Rullo + 3 catenacci Roller latch and 3 dead bolts		
7304R/2IN	30	42	45			
7304R/3IN	35	47	50			
7323UGAN/1	25	34	40	3 ganci 3 hook dead bolts	23x6 mm 	
7323UGAN/2	30	39	45			
7323UGAN/3	35	44	50			
7092U/1	25	34	40	Scrocco + 3 catenacci. Fori DIN Spring latch and 3 dead bolts. Din Standard	23x6 mm 	92
7092U/2	30	39	45			
7092U/3	35	44	50			
7092UC/1	25	34	40	Solo 3 catenacci. Fori DIN 3 dead bolts only. Din Standard		
7092UC/2	30	39	45			
7092UC/3	35	44	50			
7092UR/1	25	34	40	Rullo + 3 catenacci. Fori DIN Roller latch and 3 dead bolts. Din Standard		
7092UR/2	30	39	45			
7092UR/3	35	44	50			
7094P/1	25	37	40	Scrocco + 3 catenacci. Fori DIN Spring latch and 3 dead bolts. Din Standard	24x3 mm 	92
7094P/2	30	42	45			
7094P/3	35	47	50			
7094PC/1	25	37	40	Solo 3 catenacci. Fori DIN 3 dead bolts only. Din Standard		
7094PC/2	30	42	45			
7094PC/3	35	47	50			
7094PR/1	25	37	40	Rullo + 3 catenacci. Fori DIN Roller latch and 3 dead bolts. Din Standard		
7094PR/2	30	42	45			
7094PR/3	35	47	50			



CARATTERISTICHE

3 catenacci **avanzanti**

Funzioni: scrocco / rullo regolabile con catenaccio, solo catenaccio

Reversibile

Frontale piatto 24 x 3 mm o ad U 23 x 6 mm **in acciaio inox** con lunghezza fissa di 1.570 mm

Il frontale fisso evita misure e tagli supplementari nell'installazione (**praticità in officina**) e occupa minore spazio (**praticità nel magazzino**)

La multipunto è installabile prima di assemblare le varie parti della porta (**praticità in officina**)

Prolunghe **in acciaio inox** (opzionali) per un **vantaggio estetico a porta ultimata**

Interasse 85 mm

Entrate 25, 30, 35 mm

Abbinabile a tutti i tipi di cilindro (opzionali):

Serie 115-116, RK6

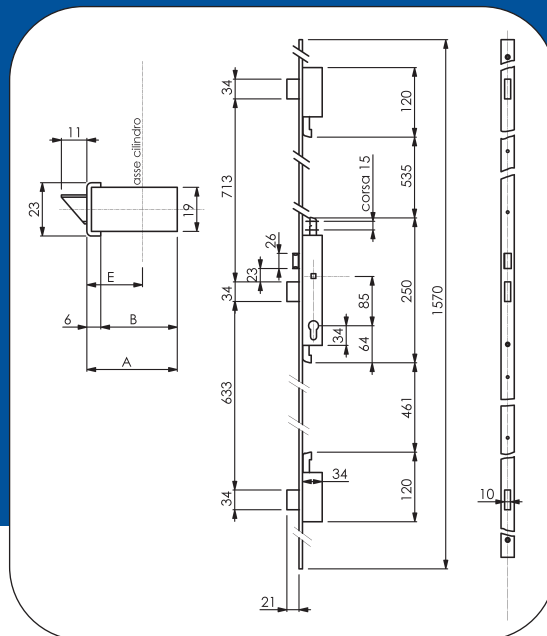

FEATURES

3 dead bolts

Functions: spring latch / adjustable roller latch and dead bolt, dead bolt only

Reversible

Flat forend 24 x 3 mm or U shaped forend 23 x 6 mm, **stainless steel**, length 1.570 mm

The fixed forend avoids cuts during the installation (**convenient in workshops**) and limits number of references (**convenient in warehouses**)

Multipoint locks can be installed before assembling the door (**convenient in workshops**)

The **stainless steel** extensions (optional) **improves the door look**



Centre distance 85 mm

Backsets 25, 30, 35 mm

Cylinders to be ordered separately: **115-116 series, RK6**

4 pz.

4 pcs.

Articolo Article	Entrata Backset E	Quote Dimensions B A		Descrizione Description	Frontale Forend
7400/1	25	34	40	Scrocco + 3 catenacci Spring latch and 3 dead bolts	23x6 mm 
7400/2	30	39	45		
7400/3	35	44	50		
7400C/1	25	34	40	Solo 3 catenacci 3 dead bolts only	
7400C/2	30	39	45		
7400C/3	35	44	50		
7400R/1	25	34	40	Rullo + 3 catenacci Roller latch and 3 dead bolts	
7400R/2	30	39	45		
7400R/3	35	44	50		
7404/1IN	25	37	40	Scrocco + 3 catenacci Spring latch and 3 dead bolts	24x3 mm 
7404/2IN	30	42	45		
7404/3IN	35	47	50		
7404C/1IN	25	37	40	Solo 3 catenacci 3 dead bolts only	
7404C/2IN	30	42	45		
7404C/3IN	35	47	50		
7404R/1IN	25	37	40	Rullo + 3 catenacci Roller latch and 3 dead bolts	
7404R/2IN	30	42	45		
7404R/3IN	35	47	50		

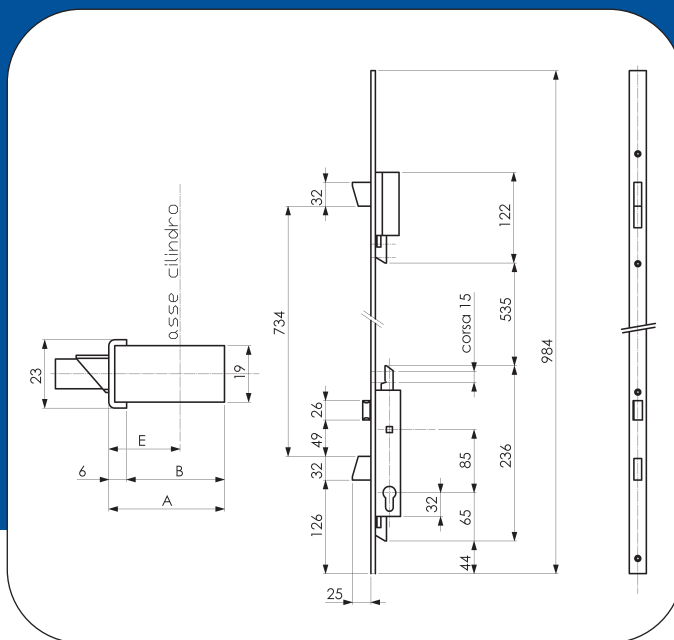

CARATTERISTICHE

2 catenacci **basculanti**
 Funzioni: scrocco con catenaccio, solo catenaccio, gancio
 Reversibile
 Frontale ad U 23 x 6 mm **in acciaio inox** con lunghezza fissa di 984 mm
 Interasse 85 mm
 Entrate 25, 30, 35 mm
 Abbinabile a tutti i tipi di cilindri (opzionali): **Serie 115-116-117, RK6 e Spillo**

FEATURES

2 *tilting* dead bolts
 Functions: *spring latch and dead bolt, dead bolt only, hook dead bolt*
 Reversible
 Forend U shaped 23 x 6 mm, **stainless steel**, length 984 mm
 Centre distance 85 mm
 Backsets 25, 30, 35 mm
 Cylinders to be ordered separately: **115-116-117 series, RK6, Cross key**

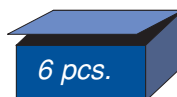
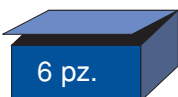

Articolo Article	Entrata Backset E	Quote Dimensions B A		Descrizione Description
7322U/1	25	34	40	Scrocco + 2 catenacci Spring latch and 2 dead bolts
7322U/2	30	39	45	
7322U/3	35	44	50	
7322UC/1	25	34	40	Solo 2 catenacci 2 dead bolts only
7322UC/2	30	39	45	
7322UC/3	35	44	50	
7322UGAN/1	25	34	40	2 ganci 2 hook dead bolts
7322UGAN/2	30	39	45	
7322UGAN/3	35	44	50	

ACCESSORI ACCESSOIRES

Prolunga per multipunto
Extension for multipoint locks

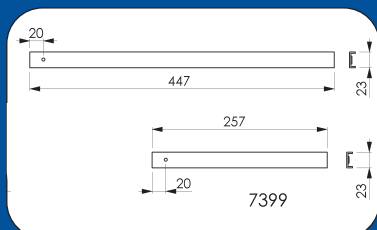
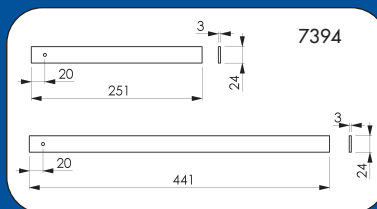
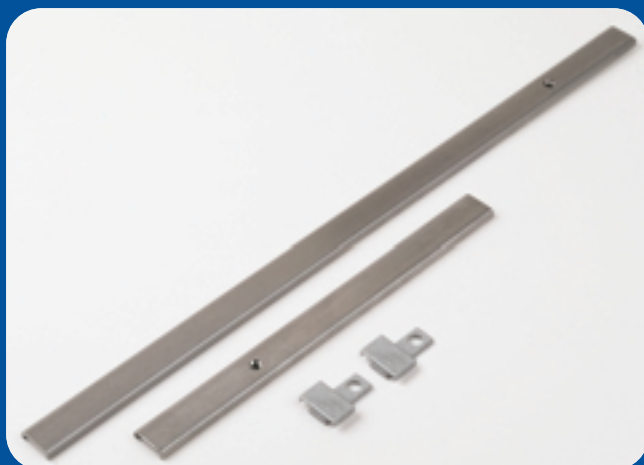

CARATTERISTICHE

Prolungha in **acciaio inox** per abbellire la porta
Parte inferiore fissa (maniglia a 1050 mm da terra). Parte superiore rasabile **per porte alte fino a 2.300 mm**
Serve **solo un taglio** per adattarsi all'altezza della porta
Giunti e terminali di finitura in nylon

FEATURES

The **stainless steel** extensions **improves the door look**
The bottom side is fixed (**distance handle/floor 1050 mm**). The top side can be trimmed off **for doors up to 2300 mm**
A cut only is needed to fit the door height
Nylon joints and finishing terminals

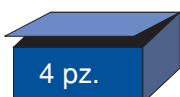

ACCESSORI ACCESSOIRES

La gamma
Range

Articolo Article	Frontale Forend	Descrizione Description
7399/U	23x6 mm 	Prolunga Extension
7394/P	24x3 mm 	

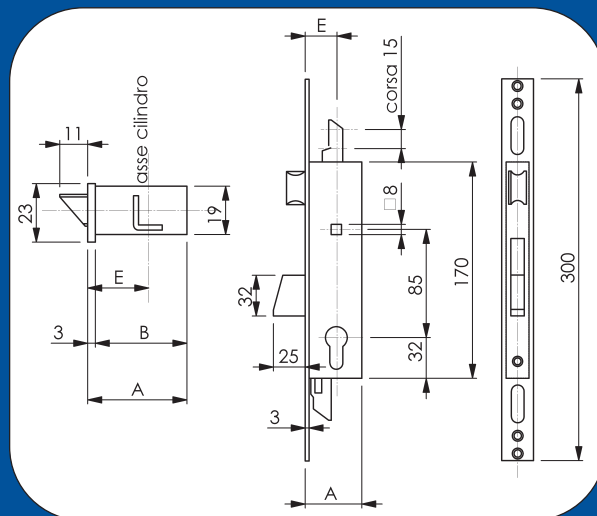

CARATTERISTICHE

Catenaccio **basculante**

Funzioni: scrocco / rullo regolabile con catenaccio, solo catenaccio, gancio

Reversibile

1 o 3 punti di chiusura

Asole per il **montaggio facilitato delle aste** interne / esterne

Coprifrontale in **acciaio inox**

Interasse 85 o 92 mm

Entrate 25, 30, 35 mm

Abbinabile a tutti i tipi di cilindri (opzionali):

Serie 115-116, RK6 e Spillo

FEATURES

Tilting dead bolts

Functions: spring latch / adjustable roller latch and dead bolt, dead bolt only, hook dead bolt

Reversible

1 or 3 locking points

*Slots for **easy rod fixing***

***Stainless steel** forend cover*

Centre distance 85 o 92 mm



Backsets 25, 30, 35 mm

Cylinders to be ordered separately:

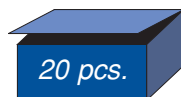
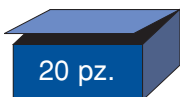
115-116 series, RK6, Cross key



Articolo Article	Entrata E Backset	Quote B Dimensions A		Descrizione Description	N° chiusure Nr locking point	Frontale Forend	Interasse Distance
7601P/1	25	37	40	Scrocco + catenaccio <i>Spring latch and dead bolt</i>	1	22x3 mm	85
7601P/2	30	42	45				
7601P/3	35	47	50				
7601PC/1	25	37	40	Solo catenaccio <i>Dead bolt only</i>			
7601PC/2	30	42	45				
7601PC/3	35	47	50				
7601PR/1	25	37	40	Rullo + catenacci <i>Roller latch and dead bolt</i>			
7601PR/2	30	42	45				
7601PR/3	35	47	50				
7603P/1	25	37	40	Scrocco + catenaccio <i>Spring latch and dead bolt</i>	3	22x3 mm	85
7603P/2	30	42	45				
7603P/3	35	47	50				
7603PC/1	25	37	40	Solo catenaccio <i>Dead bolt only</i>			
7603PC/2	30	42	45				
7603PC/3	35	47	50				
7603PR/1	25	37	40	Rullo + catenacci <i>Roller latch and dead bolt</i>			
7603PR/2	30	42	45				
7603PR/3	35	47	50				
7611P/1	25	37	40	Scrocco + catenaccio <i>Spring latch and dead bolt</i>	1	25x3 mm	
7611P/2	30	42	45				
7611P/3	35	47	50				
7611PC/1	25	37	40	Solo catenaccio <i>Dead bolt only</i>			
7611PC/2	30	42	45				
7611PC/3	35	47	50				
7611PR/1	25	37	40	Rullo + catenacci <i>Roller latch and dead bolt</i>			
7611PR/2	30	42	45				
7611PR/3	35	47	50				
7613P/1	25	37	40	Scrocco + catenaccio <i>Spring latch and dead bolt</i>	3	25x3 mm	
7613P/2	30	42	45				
7613P/3	35	47	50				
7613PC/1	25	37	40	Solo catenaccio <i>Dead bolt only</i>			
7613PC/2	30	42	45				
7613PC/3	35	47	50				
7613PR/1	25	37	40	Rullo + catenacci <i>Roller latch and dead bolt</i>			
7613PR/2	30	42	45				
7613PR/3	35	47	50				
7601/25GAN	25	37	40	Gancio <i>Hook deadbolt</i>	1		
7601/30GAN	30	42	45				
7601/35GAN	35	47	50				
7613/25GAN	25	37	40		3		
7613/30GAN	30	42	45				
7613/35GAN	35	47	50				

Articolo Article	Entrata E Backset	Quote B Dimensions A		Descrizione Description	N° chiusure Nr locking point	Frontale Forend	Interasse Distance
7691P/1	25	37	40	Scrocco + catenaccio. Fori DIN <i>Spring latch and dead bolt. DIN Standard</i>	1	22x3 mm 	92
7691P/2	30	42	45				
7691P/3	35	47	50				
7691PC/1	25	37	40	Solo catenaccio. Fori DIN <i>Dead bolt only. DIN Standard</i>			
7691PC/2	30	42	45				
7691PC/3	35	47	50				
7691PR/1	25	37	40	Rullo + catenaccio. Fori DIN <i>Roller latch and dead bolt. DIN Standard</i>			
7691PR/2	30	42	45				
7691PR/3	35	47	50				
7693P/1	25	37	40	Scrocco + catenaccio. Fori DIN <i>Spring latch and dead bolt. DIN Standard</i>	3		
7693P/2	30	42	45				
7693P/3	35	47	50				
7693PC/1	25	37	40	Solo catenaccio. Fori DIN <i>Dead bolt only. DIN Standard</i>			
7693PC/2	30	42	45				
7693PC/3	35	47	50				
7693PR/1	25	37	40	Rullo + catenaccio. Fori DIN <i>Roller latch and dead bolt. DIN Standard</i>			
7693PR/2	30	42	45				
7693PR/3	35	47	50				
7691U/1	25	34	40	Scrocco + catenaccio. Fori DIN <i>Spring latch and dead bolt. DIN Standard</i>	1	23x6 mm 	
7691U/2	30	39	45				
7691U/3	35	44	50				
7691UC/1	25	34	40	Standard DIN Solo catenaccio. Fori DIN <i>Dead bolt only. DIN Standard</i>			
7691UC/2	30	39	45				
7691UC/3	35	44	50				
7691UR/1	25	34	40	Rullo + catenaccio. Fori DIN <i>Roller latch and dead bolt. DIN Standard</i>			
7691UR/2	30	39	45				
7691UR/3	35	44	50				

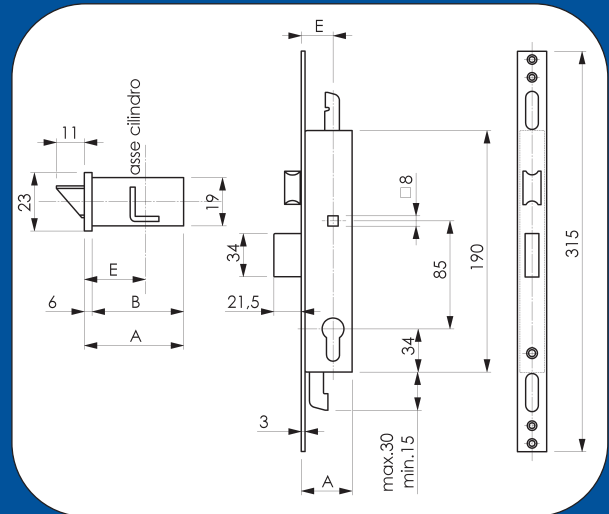





CARATTERISTICHE

Catenaccio **avanzante**
 Funzioni: scrocco / rullo regolabile con catenaccio, solo catenaccio
 Reversibile
 1 o 3 punti di chiusura
 Asole per il **montaggio facilitato delle aste** interne / esterne
 Coprifrontale **in acciaio inox**
 Interasse 85 mm
 Entrate 25, 30, 35 mm
 Abbinabile a tutti i tipi di cilindro (opzionali):
Serie 115-116, RK6

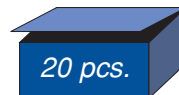
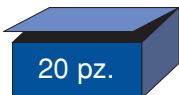
FEATURES

Single throw dead bolt
 Functions: spring latch / adjustable roller latch and dead bolt, dead bolt only
 Reversible
 1 or 3 locking points
 Slots for **easy rod fixing**
Stainless steel forend cover
 Centre distance 85 mm
 Backsets 25, 30, 35 mm
 Cylinders to be ordered separately: **115-116 series, RK6**



Articolo Article	Entrata E Backset	Quote B Dimensions A		Descrizione Description	N° chiusure Nr locking point	Frontale Forend
7651P/1	25	37	40	Scrocco + catenaccio <i>Spring latch and dead bolt</i>	1	22x3 mm 
7651P/2	30	42	45			
7651P/3	35	47	50			
7651PC/1	25	37	40	Solo catenaccio <i>Dead bolt only</i>		
7651PC/2	30	42	45			
7651PC/3	35	47	50			
7651PR/1	25	37	40	Rullo + catenacci <i>Roller latch and dead bolt</i>		
7651PR/2	30	42	45			
7651PR/3	35	47	50			
7653P/1	25	37	40	Scrocco + catenaccio <i>Spring latch and dead bolt</i>	3	22x3 mm 
7653P/2	30	42	45			
7653P/3	35	47	50			
7653PC/1	25	37	40	Solo catenaccio <i>Dead bolt only</i>		
7653PC/2	30	42	45			
7653PC/3	35	47	50			
7653PR/1	25	37	40	Rullo + catenacci <i>Roller latch and dead bolt</i>		
7653PR/2	30	42	45			
7653PR/3	35	47	50			
7655P/1	25	37	40	Scrocco + catenaccio <i>Spring latch and dead bolt</i>	1	25x3 mm 
7655P/2	30	42	45			
7655P/3	35	47	50			
7655PC/1	25	37	40	Solo catenaccio <i>Dead bolt only</i>		
7655PC/2	30	42	45			
7655PC/3	35	47	50			
7655PR/1	25	37	40	Rullo + catenacci <i>Roller latch and dead bolt</i>		
7655PR/2	30	42	45			
7655PR/3	35	47	50			
7658P/1	25	37	40	Scrocco + catenaccio <i>Spring latch and dead bolt</i>	3	25x3 mm 
7658P/2	30	42	45			
7658P/3	35	47	50			
7658PC/1	25	37	40	Solo catenaccio <i>Dead bolt only</i>		
7658PC/2	30	42	45			
7658PC/3	35	47	50			
7658PR/1	25	37	40	Rullo + catenacci <i>Roller latch and dead bolt</i>		
7658PR/2	30	42	45			
7658PR/3	35	47	50			

DOPPIA MAPPA

Serratura da montante a doppia mappa a 1-3 punti di chiusura

Multilever narrow style lock 1 or 3 locking points

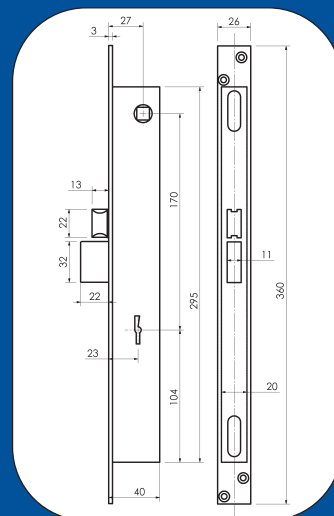

CARATTERISTICHE

Funzioni: scrocco / rullo regolabile con catenaccio, solo catenaccio
 Reversibile
 1 o 3 punti di chiusura
 Catenaccio a 2 mandate
 Coprifrontale in acciaio inox 26x3mm

FEATURES

Functions: spring latch / adjustable roller latch with dead bolt, dead bolt only
 Reversible
 1 or 3 locking points
 2 throws dead bolt
 Stainless steel forend cover 26x3 mm

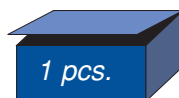
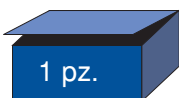

DOPPIA MAPPA

La gamma

Range

Articolo Article	Descrizione Descrizione	N° chiusure Nr locking point	Nota Note
6601	Scrocco + catenaccio Spring latch and dead bolt	1	Con incontro Striking plate included
6601C	Solo catenaccio Dead bolt only		
6601R	Rullo + catenaccio Roller and dead bolt		
6603	Scrocco + catenaccio Spring latch and dead bolt	3	Senza incontro Striking plate excluded
6603C	Solo catenaccio Dead bolt only		
6603R	Rullo + catenaccio Roller and dead bolt		

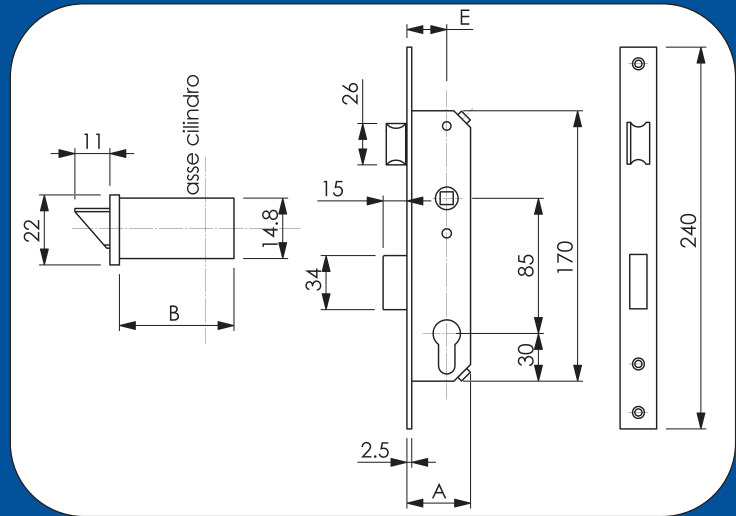

CARATTERISTICHE

Funzioni: scrocco / rullo regolabile con catenaccio
 Catenaccio **monomandata maggiorata di 15mm**
 Reversibile
 Frontale in **acciaio inox, removibile**
 Interasse 85 mm
 Entrate 20, 25, 30, 35 mm
 Con incontro piatto 22x3 mm in acciaio
 Abbinabile a tutti i tipi di cilindro (opzionali):
Serie 115 - 116, RK6

FEATURES

Functions: spring latch / adjustable roller latch with
 dead bolt
 Single throw dead bolt **15mm**
 Reversible
Stainless steel removable forend
 Centre distance 85 mm
 Backsets 20, 25, 30, 35 mm
 Flat striking plate 22x3 mm included
 Cylinders to be ordered separately:
115-116 series, RK6

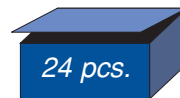
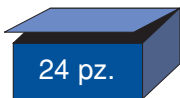

Articolo Article	Entrata Backset E	B	Quote Dimensions	A	Descrizione Description
7661	20	32,5	35		Scrocco + catenaccio Spring latch and dead bolt
7661/1	25	37,5	40		
7661/2	30	42,5	45		
7661/3	35	47,5	50		
7661R	20	32,5	35		Rullo + catenaccio Roller latch and dead bolt
7661R/1	25	37,5	40		
7661R/2	30	42,5	45		
7661R/3	35	47,5	50		

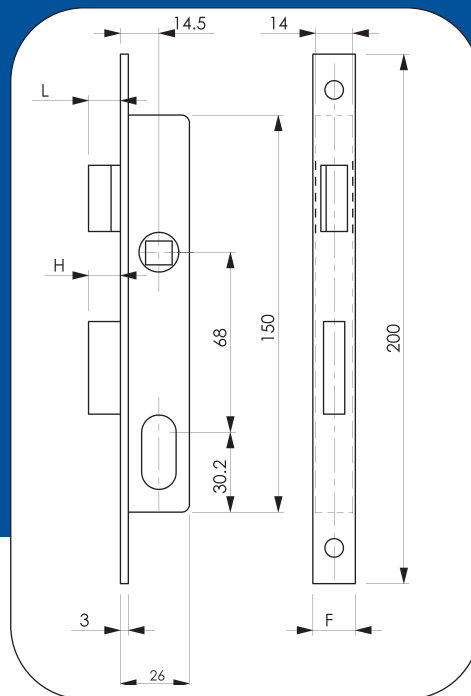

CARATTERISTICHE

Funzioni: scrocco / rullo regolabile con catenaccio
Catenaccio monomandata
Reversibile
Frontale 16 e 20 mm

FEATURES

Functions: spring latch / adjustable roller with dead bolt
Single throw dead bolt
Reversible
Forend 16 and 20 mm

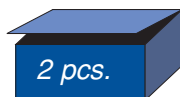
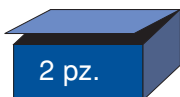

Articolo Article	Quote Dimensions			Descrizione Description
	F	L	H	
6560	16	12	12	Scrocco + catenaccio Spring latch and dead bolt
6561	20	12	12	
6570	16	-	12	Rullo + catenaccio Roller latch and dead bolt
6571	20	-	12	

CARATTERISTICHE

Solo rullo regolabile
Solo scrocco reversibile, azionato dal cilindro
Solo catenaccio
Solo scrocco reversibile, azionato dalla maniglia

FEATURES

Adjustable roller only
Reversible spring latch by cylinder
Dead bolt only
Reversible spring latch by handle

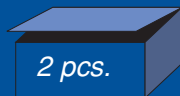
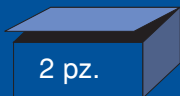

Articolo Article	Quote Dimension F	Descrizione Description		
6520	16	Rullo Roller latch		
6521	20			
6530	16	Scrocco (tramite cilindro) Spring latch by cylinder		
6531	20			
6540	16	Solo catenaccio Dead bolt only		
6541	20			
6550	16	Scrocco (tramite maniglia) Spring latch by handle		
6551	20			



ART. 7619

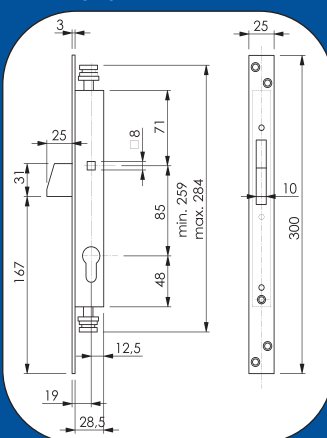

ART. 7619 /1/2/3

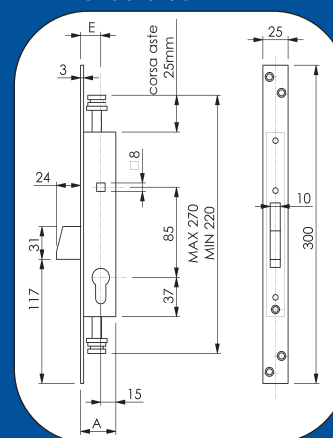

CARATTERISTICHE

Funzione: solo catenaccio azionato dalla maniglia.
La chiave blocca la maniglia
Applicazione in montanti **tubolari stretti di 30 mm**
(entrata 19)
Reversibile
Interasse 85
Entrate **19, 25, 30, 35 mm**
3 punti di chiusura
Corsa aste di 25 mm (12,5 mm per la sola entrata 19)
Attacco aste filettato M8
Autoblocco della maniglia a fine corsa (sistema antieffrazione nel caso di ante cieche) per le entrate 25, 30, 35 mm
Abbinabile a tutti i tipi di mezzo cilindro (opzionali):
Serie 117-119 (specifico per entrata 19 mm), RK6

FEATURES

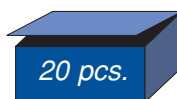
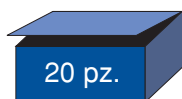

Function: dead bolt only by handle. The key locks the handle
Reversible
Centre distance 85 mm
Backsets 19, 25, 30, 35 mm
3 locking points
Rod range 25 mm (backset 19 only 12,5 mm)
Threaded M8 rod joint
Self locking handle for backsets 25,30,35 mm (burglar-proof system for fixed leaves)
Single cylinder to be ordered separately: **117 series, (119 series specific for backset 19 mm), RK6**



SERIE 19

La gamma Range

Articolo Article	E Entrata Backset	Quote Dimensions	A	Descrizione Description
7619	19	31,5		Catenaccio azionato dalla maniglia Dead bolt operated by handle
7619/1	25	40		
7619/2	30	45		
7619/3	35	50		
7619/KIT	19	31,5		Kit composto da serratura 7619 + maniglia 7629 + mezzo cilindro 119/2 + incontro 6347 The kit is consists of: lock 7619 + handle 7629 + single cylinder 119/2 + striking plate 6347

Articolo Article	Descrizione Description		
7629	Maniglia singola con quadro 8mm <i>Single handle, square pin 8mm</i>		20
7639	Coppia aste da 1100 mm cad. con innesti M8, puntali esclusi <i>Set of vertical rods 1100 mm, without shoot ends</i>		10
7649	Coppia puntali diam.10 mm, da cianfrinare <i>Set of shoot ends 10 mm</i>		1
6814	Coppia puntali diam. 8 mm da piantare <i>Set of shoot ends 8 mm</i>		1
6347	Incontro per serratura in acciaio inox <i>Stainless steel striking plate</i>		1

CARATTERISTICHE

Solo catenaccio avanzante
Solo gancio
Solo catenaccio basculante
Con incontro in acciaio

FEATURES

Dead bolt only
Hook dead bolt only
Tilting dead bolt only
Striking plate included

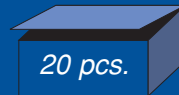
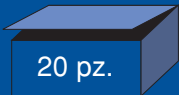

Articolo Article	Descrizione Description		
5810	Catenaccio avanzante, frontale 16 mm. 3 chiavi <i>Dead bolt, forend 16 mm with 3 keys</i>		
5811	Catenaccio avanzante, frontale 20 mm. 3 chiavi <i>Dead bolt, forend 20 mm with 3 keys</i>		
5815	Gancio. 3 chiavi <i>Hook dead bolt with 3 keys</i>		
5820	Catenaccio basculante. 3 chiavi <i>Tilting dead bolt with 3 keys</i>		

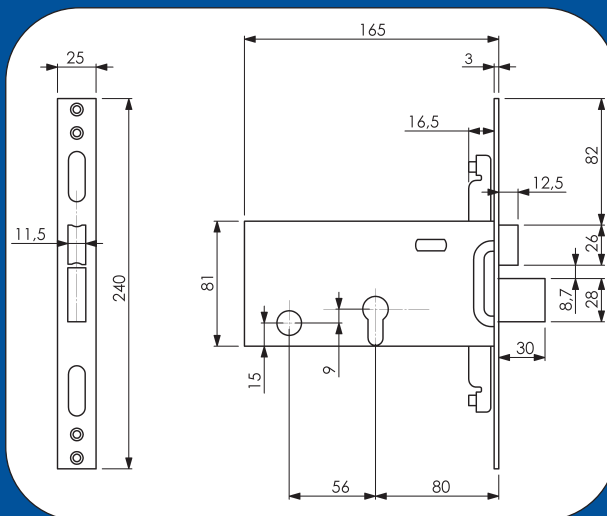

CARATTERISTICHE

Funzioni: scrocco / rullo regolabile con catenaccio, solo catenaccio

Catenaccio a **3 mandate**

Reversibile

1 o 3 punti di chiusura

Asole per il **montaggio facilitato delle aste** interne/esterne

Coprifrontale in **acciaio inox**

Entrata 80 mm

Abbinabile a tutti i tipi di cilindro (opzionali):

Serie 115-116

FEATURES

Functions: spring latch / adjustable roller latch and dead bolt, dead bolt only

3 throws dead bolt

Reversible

1 or 3 locking points

Slots for **easy rod fixing**

Stainless steel forend cover

Backset 80 mm

Cylinders to be ordered separately: **115-116 series**

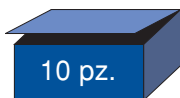

10 pz.

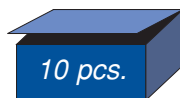

10 pcs.

Articolo Article	Descrizione Description	N° chiusure Nr locking point
5601	Scrocco + catenaccio Spring latch and dead bolt	1
5601C	Solo catenaccio Dead bolt only	
5601R	Rullo + catenaccio Roller latch and dead bolt	
5613	Scrocco + catenaccio Spring latch and dead bolt	3
5613C	Solo catenaccio Dead bolt only	
5613R	Rullo + catenaccio Roller latch and dead bolt	

DOPPIA MAPPA Serratura da fascia a doppia mappa a 1-3 punti di chiusura Multilever midrail lock 1 or 3 locking points

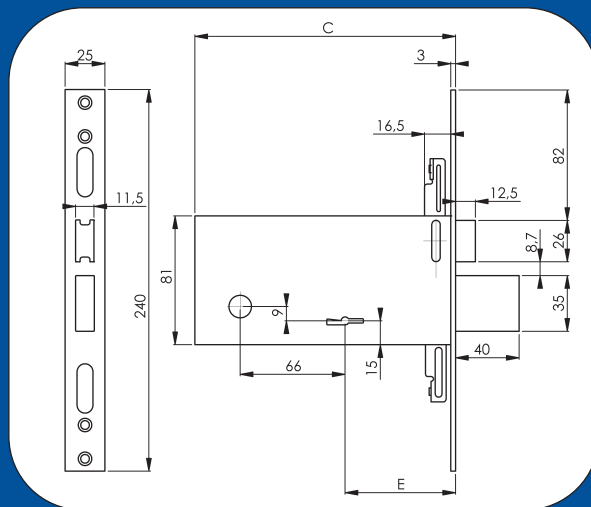

CARATTERISTICHE

Funzioni: scrocco / rullo regolabile con catenaccio, solo catenaccio
 Catenaccio a **4 mandate**
 Reversibile
 1 o 3 punti di chiusura
 Asole per il **montaggio facilitato delle aste** interne/esterne
 Coprifrontale in **acciaio inox**
 Entrate 70 e 90 mm

FEATURES

Functions: spring latch / adjustable roller latch and dead bolt, dead bolt only
4 throws dead bolt
 Reversible
 1 or 3 locking points
 Slots for **easy rod fixing**
Stainless steel forend cover
 Backsets 70 e 90 mm

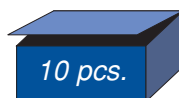
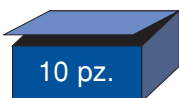

DOPPIA MAPPA

La gamma Range

Articolo Article	Entrata E Backset	Quote C Dimensions	Descrizione Description	N° chiusure Nr locking point	Note Notes
6801/SA	70	165	Scrocco + catenaccio <i>Spring latch and dead bolt</i>	1	Non intercambiabili con le serie 6871/3 e 6891/3
6801C/SA	70	165	Solo catenaccio <i>Bolt only</i>		
6801R/SA	70	165	Rullo + catenaccio <i>Roller latch and dead bolt</i>		
6803/SA	70	165	Scrocco + catenaccio <i>Spring latch and dead bolt</i>	3	Not suitable to 6871/3 and 6891/3
6803C/SA	70	165	Solo catenaccio <i>Bolt only</i>		
6803R/SA	70	165	Rullo + catenaccio <i>Roller latch and dead bolt</i>		
6871	70	165	Scrocco + catenaccio <i>Spring latch and dead bolt</i>	1	Versione unificata per aste interne ed esterne
6871C	70	165	Solo catenaccio <i>Bolt only</i>		
6871R	70	165	Rullo + catenaccio <i>Roller latch and dead bolt</i>		
6873	70	165	Scrocco + catenaccio <i>Spring latch and dead bolt</i>	3	
6873C	70	165	Solo catenaccio <i>Bolt only</i>		
6873R	70	165	Rullo + catenaccio <i>Roller latch and dead bolt</i>		
6891	90	185	Scrocco + catenaccio <i>Spring latch and dead bolt</i>	1	Standardized version for both internal and external rods
6891C	90	185	Solo catenaccio <i>Bolt only</i>		
6891R	90	185	Rullo + catenaccio <i>Roller latch and dead bolt</i>		
6893	90	185	Scrocco + catenaccio <i>Spring latch and dead bolt</i>	3	
6893C	90	185	Solo catenaccio <i>Bolt only</i>		
6893R	90	185	Rullo + catenaccio <i>Roller latch and dead bolt</i>		

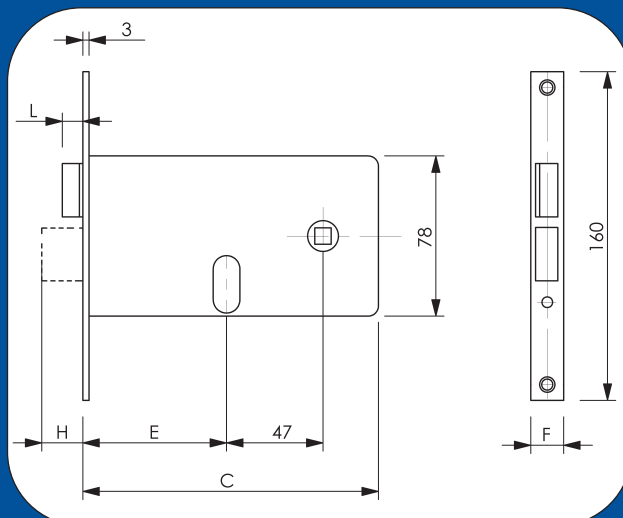

CARATTERISTICHE

Funzioni: scrocco / rullo regolabile con catenaccio
Reversibile
Frontale 16 e 20 mm
Entrate 58, 60, 70, 80 mm

FEATURES

Functions: spring latch / adjustable roller latch with dead bolt
Reversible
Forend 16 e 20 mm
Backsets 58, 60, 70, 80 mm

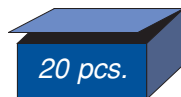
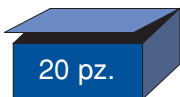

Articolo Article	Quote Dimensions					Descrizione Description	Nota Notes
	E	F	C	H	L		
6451	58	16	134	20	10	Scrocco + catenaccio <i>Spring latch and dead bolt</i>	Con cilindro 54 mm 54 mm cylinder
6451R	58	16	134	20	-	Rullo + catenaccio <i>Roller latch and dead bolt</i>	
6452	58	20	134	20	10	Scrocco + catenaccio <i>Spring latch and dead bolt</i>	
6452R	58	20	134	20	-	Rullo + catenaccio <i>Roller latch and dead bolt</i>	
6453	60	16	134	20	10	Scrocco + catenaccio <i>Spring latch and dead bolt</i>	
6453R	60	16	134	20	-	Rullo + catenaccio <i>Roller latch and dead bolt</i>	
6454	60	20	134	20	10	Scrocco + catenaccio <i>Spring latch and dead bolt</i>	
6454R	60	20	134	20	-	Rullo + catenaccio <i>Roller latch and dead bolt</i>	
6455	70	16	144	20	10	Scrocco + catenaccio <i>Spring latch and dead bolt</i>	
6455R	70	16	144	20	-	Rullo + catenaccio <i>Roller latch and dead bolt</i>	
6456	70	20	144	20	10	Scrocco + catenaccio <i>Spring latch and dead bolt</i>	
6456R	70	20	144	20	-	Rullo + catenaccio <i>Roller latch and dead bolt</i>	
6457	80	16	154	20	10	Scrocco + catenaccio <i>Spring latch and dead bolt</i>	
6457R	80	16	154	20	-	Rullo + catenaccio <i>Roller latch and dead bolt</i>	
6458	80	20	154	20	10	Scrocco + catenaccio <i>Spring latch and dead bolt</i>	
6458R	80	20	154	20	-	Rullo + catenaccio <i>Roller latch and dead bolt</i>	
6459	80	14,5	154	25	15	Scrocco + catenaccio <i>Spring latch and dead bolt</i>	Senza cilindro <i>Without cylinder</i>
6460	80	16	154	20	10	Scrocco + catenaccio <i>Spring latch and dead bolt</i>	Senza cilindro. Con sottofrontale art.6348 <i>Without cylinder. With nylon shim 6348</i>

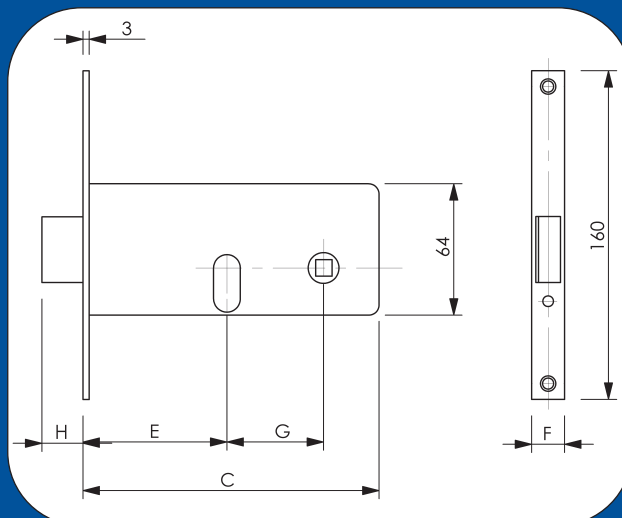

CARATTERISTICHE

Funzioni: scrocco con catenaccio incorporato
Reversibile
Frontale 16 e 20 mm
Entrate 60, 70, 80 mm

FEATURES

Functions: spring latch convertible into dead bolt
Reversible
Forend 16 and 20 mm
Backsets 60, 70, 80 mm

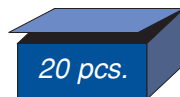
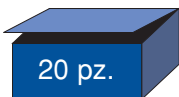

SCATTO

La gamma Range

Articolo Article	Quote		Dimensions			Descrizione Description	Nota Notes
	E	F	C	H	G		
6421	60	16	134	30	47	Scrocco con mandata Spring latch convertible into deadbolt	Cilindro 54 mm 54 mm cylinder
6422	60	20	134	30	47		
6423	70	16	164	30	67		
6424	70	20	164	30	67		
6425	80	16	164	30	67		
6426	80	20	164	30	67		
6427	80	14,5	164	35	67		Senza cilindro Without cylinder
6429	80	16	164	30	67	Senza cilindro. Con sottofrontale art.6348 Without cylinder. With nylon shim 6348	

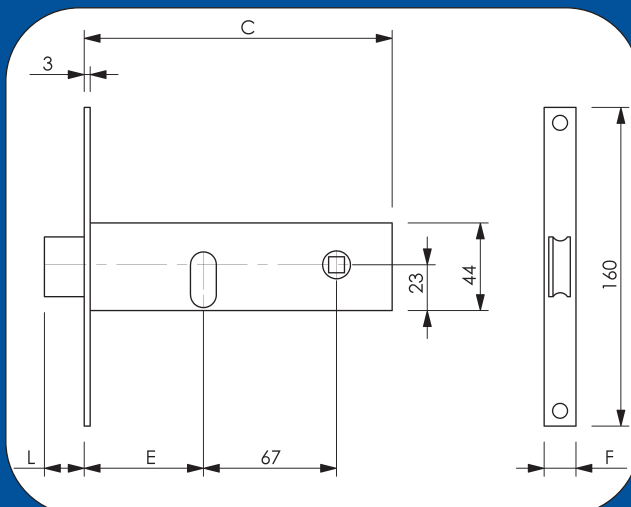

CARATTERISTICHE

Funzioni: scrocco con catenaccio incorporato
 Reversibile
 Frontale 16 e 20 mm
 Entrate 60, 70, 80 mm

FEATURES

Functions: spring latch convertible into dead bolt
 Reversible
 Forend 16 e 20 mm
 Backsets 60, 70, 80 mm

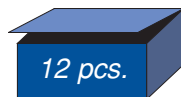
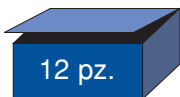

Articolo Article	Quote Dimensions				Descrizione Description	Nota Notes
	E	F	C	L		
6501	60	16	155	20	Scrocco con mandata Spring latch convertible into deadbolt	Con cilindro 54 mm 54 mm cylinder
6502	70	16	165	30		Senza cilindro Without cylinder
6502SC	70	16	165	30		Con cilindro 54 mm 54 mm cylinder
6503	60	20	155	20		Senza cilindro Without cylinder
6504	70	20	165	30		Con cilindro 54 mm 54 mm cylinder
6504SC	70	20	165	30		Senza cilindro Without cylinder
6506	80	20	175	30		Con cilindro 54 mm 54 mm cylinder
6506SC	80	20	175	30		Senza cilindro Without cylinder

TRIPLA SPILLO

Serratura da fascia a 1-3 punti di chiusura
Midrail lock 1 or 3 locking points with cross key

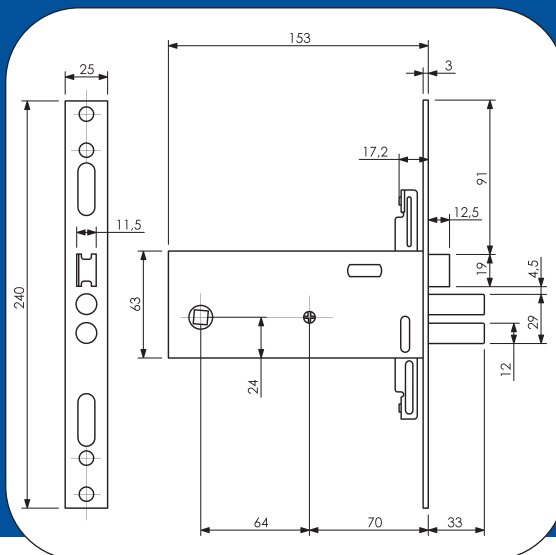

CARATTERISTICHE

Funzioni: scrocco/rullo regolabile con catenaccio, solo catenaccio
Catenaccio a pistoni a **3 mandate**
Reversibile
1 o 3 punti di chiusura
Asole per il **montaggio facilitato delle aste** interne/esterne
Coprifrontale in **acciaio inox**
Entrata 70 mm

FEATURES

Functions: spring latch / adjustable roller latch and dead bolt, dead bolt only
3 throws dead bolt
Reversible
1 or 3 locking points
Slots for **easy rod fixing**
Stainless steel forend cover
Backset 70 mm

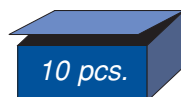
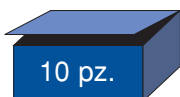

Articolo Article	Descrizione Description	N° chiusure Nr locking point
5651	Scrocco + catenaccio Spring latch and dead bolt	1
5651C	Solo catenaccio Dead bolt only	
5651R	Rullo + catenaccio Roller latch and dead bolt	3
5653	Scrocco + catenaccio Spring latch and dead bolt	
5653C	Solo catenaccio Dead bolt only	
5653R	Rullo + catenaccio Roller latch and dead bolt	

CARATTERISTICHE

Solo catenaccio
Da applicare e infilare
3 chiavi
Incontro in dotazione

FEATURES

Dead bolt only
Rim and mortise lock
3 keys
Striking plate included

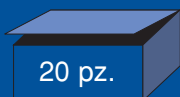

Articolo Article	Descrizione Description		
5800	Da applicare Rim lock		
5805	Da infilare Mortise lock		

SERRATURE

LOCK CASES







Gli accessori
Accessoires

Articolo Article	Note Notes	Descrizione Description	Per serrature For locks	
6806		Kit deviatori con catenaccio basculante, con aste interne <i>Set of tilting bolts rod pulleys for internal rod sections</i>	Serrature Control <i>Control locks</i>	
6807		Kit deviatori con catenaccio avanzante, con aste interne <i>Set of rod pulleys for internal rod sections</i>	Serrature con catenaccio avanzante a 3 punti di chiusura <i>Mortise locks with dead bolts 3 locking points</i>	
6814	∅ 6 mm	Coppia puntali antisega <i>Set of shoot ends saw resistant</i>	Da inserire nelle aste diritte e/o piegate <i>Vertical rods</i>	
6815	∅ 8 mm			
6348		Sottofrontale per serrature <i>Nylon shim</i>	Combi, Scatto, Stretta con frontale 16mm <i>Combi, Scatto, Stretta with 16mm forend</i>	
6816		Bocchetta a pavimento <i>Floor striker</i>		
6816/1		Bocchetta a pavimento con molla antipolvere <i>Floor striker with dust cup</i>		
6821		Coppia borchie guida chiave <i>Escutcheon</i>	Doppie mappe da fascia <i>Multilever midrail locks</i>	
6824			Doppie mappe da montante <i>Multilever narrow style locks</i>	

SERRATURE

LOCK CASES

Gli accessori
Accessoires

Articolo Article	Note Notes	Descrizione Description	Per serrature For locks	
6817		Coppia aste piegate tradizionali Vertical rods	Artt. 6603, 6803	
6822		Coppia aste diritte tradizionali Vertical rods		
6827		Coppia aste piegate unificate Vertical rods	Tutte le serrature a 3 punti di chiusura, escluso artt. 6603, 6803 Locks with 3 locking points, no for artt. 6603, 6803	
6828		Coppia aste diritte unificate Vertical rods		
6850/2	NC40Int.	Coppia attacchi per aste esterne Set for central joint flush system	Tutte le serrature a 3 punti di chiusura, escluso artt. 6603, 6803 Locks with 3 locking points, no for artt. 6603, 6803	
6850/4	Aste spess. 5mm Thick rod 5mm			
6850/6	Aste spess. 7mm Thick rod 7mm			
6850/9	Alpha			
7510	Nera Black	Doppia maniglia in lega presso fusa Double hand		
7510/GR	Grigia Grey			
7510/WH	Bianca White			

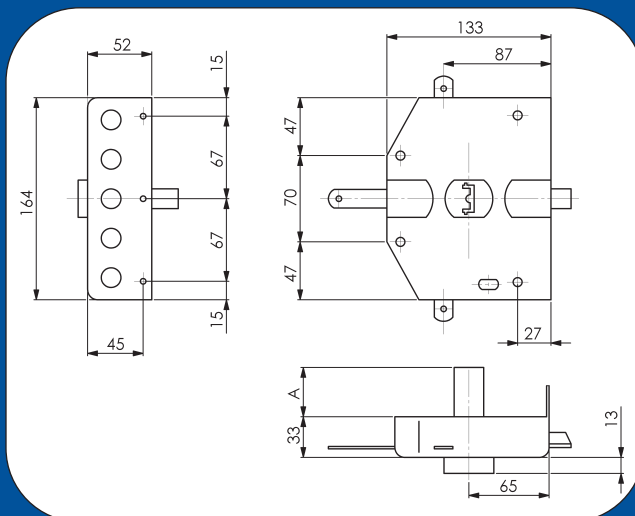
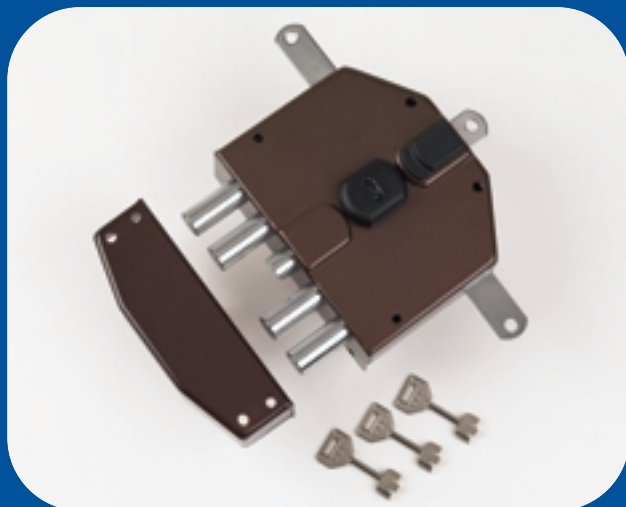

CARATTERISTICHE

Funzioni: scrocco con catenaccio e solo catenaccio
Ad 1, 3, 5 punti di chiusura
Chiave per cilindri a pompa (cilindro esterno da 50, 60, 70, 80 mm)
Mano destra (D), mano sinistra (S)
Aste da ordinare a parte

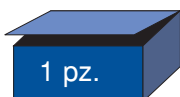

FEATURES

Functions: spring latch with dead bolts, dead bolts only
1, 3 or 5 locking points
Key for front pins cylinder (external cylinder from 50, 60, 70, 80 mm)
Right hand (D), left hand (S)
Rods to be ordered separately

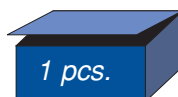

SEGRETA

La gamma Range



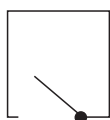



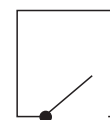



Articolo Article	Quote Dimension	Descrizione Description	N° chiusure Nr locking point	Chiave Key
7200/50	50	Scrocco + catenacci Spring latch and dead bolts	1	
7200/60	60			
7200/70	70			
7200/80	80			
7202/50	50	Solo catenacci Dead bolts only	1	
7202/60	60			
7202/70	70			
7202/80	80			
7230/50	50	Scrocco + catenacci Spring latch and dead bolts	3	
7230/60	60			
7230/70	70			
7230/80	80			
7232/50	50	Solo catenacci Dead bolts only	3	
7232/60	60			
7232/70	70			
7232/80	80			
7250/50	50	Scrocco + catenacci Spring latch and dead bolts	5	
7250/60	60			
7250/70	70			
7250/80	80			
7252/50	50	Solo catenacci Dead bolts only	5	
7252/60	60			
7252/70	70			
7252/80	80			

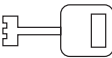

Mano DX (D)
Side RHS (D)



Mano SX (S)
Side LHS (S)

Articolo Article	Descrizione Description		
8300	Deviatore (in normale dotazione con gli art. 8250-8150) <i>Connector (included with art. 8250-8150)</i>		
8306	50mm	Cilindro a pompa <i>Front pins cylinder</i>	
8309	60mm		
8312	70mm		
8315	80mm		
8327	Placca guida chiave concava <i>Escutcheon</i>		
8330	Placca guida chiave <i>Escutcheon</i>		
8333	Placca guida chiave concava <i>Escutcheon</i>		
8342	Guida per aste <i>Rods guide</i>		
8345	Cavalotto per aste <i>Rod strikers</i>		
8339	Bocchetta a pavimento <i>Floor striker</i>		
8318	Aste per 3 punti di chiusura <i>Rod for 3 locking points</i>		
8321	Aste per 5 punti di chiusura <i>Rod for 5 locking points</i>		

PROFILATI

Cilindri a profilo europeo Euro-profile cylinders



CARATTERISTICHE

Camma DIN diritta o sporgente
3 Chiavi nichelate, in lega d'ottone
Combinazioni con 4 - 5 perni

6 pz.

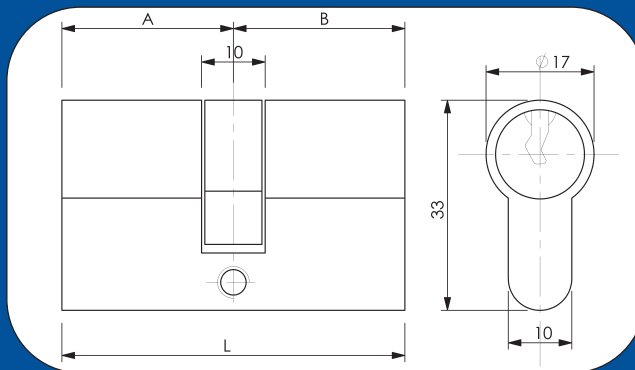

FEATURES

Standard or off center DIN cam
3 brass keys
4-5 biting pins

6 pcs.

PROFILATI

La gamma Range

Articolo Article	Quote Dimension			Perni Pins	Descrizione Description	Note Notes		
	L	A	B					
115N	54	27	27	4	Cilindro doppio Double cylinder	Camma diritta Standard cam		
115/1N	60	30	30	5				
115/2N	60	27	33	4				
115/5N	70	35	35	5				
115/6N	70	27	43	4				
115/8N	75	30	45	5				
115/9N	80	40	40	5				
115/10N	80	27	53	4				
115/12N	85	30	55	5				
116N	54	27	27	4			Cilindro doppio Double cylinder	Camma sporgente Off center cam
116/1N	60	30	30	5				
116/2N	60	27	33	4				
116/5N	70	35	35	5				
116/6N	70	27	43	4				
116/9N	80	40	40	5				
116/10N	80	27	53	4	Cilindro doppio Double cylinder	Antitrapano, antistrappo Drill and pull resistand		
118	54	27	27	4				
118/1	62	31	31	5				
118/2	62	27	35	4				
118/5	70	35	35	5				
118/6	70	27	45	4				
118/9	78	39	39	5				
118/10	80	35	45	5				
117N	37	27	10	4			Mezzi cilindri Single cylinders	Anche per maniglie Millennium - Sprint artt. 19710 -19010 / 11 Suitable for Millennium - Sprint handles artt. 19710 -19010 / 11
117/8N	39	30	9	5				
117/9N	49	39	10	5				
119/2	40	30	10	5	Cilindro doppio Double cylinder	Camma ridotta specifico per Serie19 artt. 7619 Special cam, for Serie19 artt. 7619		
190	sporgenza est. 55 mm outside projection 55 mm			5				
190/M	sporgenza est. 65 mm outside projection 65 mm			5				
190/L	sporgenza est. 82 mm outside projection 82 mm			5				
160	sporgenza est. 55 mm outside projection 55 mm			5	Mezzi cilindri Single cylinders	Specifico per Composit e Lampo solo cilindro Suitable for Composit cylinder only version and Lampo		
160/M	sporgenza est. 65 mm outside projection 65 mm			5				
160/L	sporgenza est. 82 mm outside projection 82 mm			5				

RK6

Cilindri a profilo europeo con chiave reversibile Reversible key euro-profile cylinders

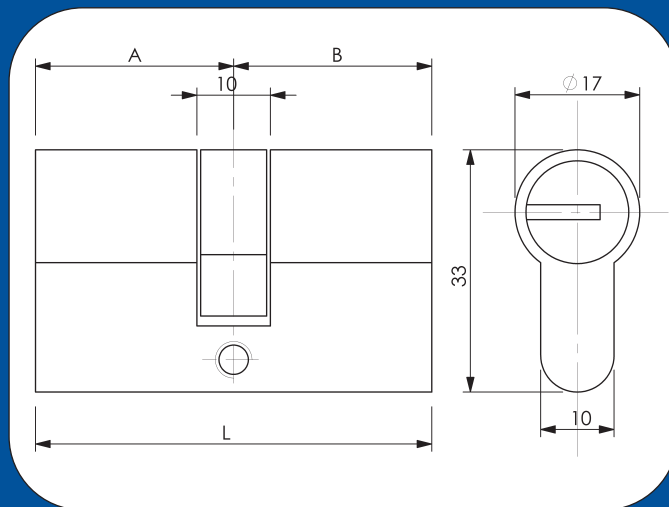

CARATTERISTICHE

Camma DIN sporgente

Chiave reversibile (praticità d'uso in ogni condizione)

5 chiavi nichelate, in lega d'ottone

Combinazioni con **6 perni**

Corpo in ottone satinato nichelato

Cofanetto individuale

Vite di fissaggio

FEATURES

Off center DIN cam

Reversible key

5 brass key

6 biting pins

Nickel plated

Individual box

Fixing screw

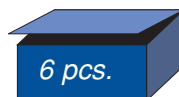
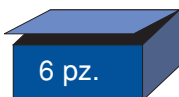

RK6

La gamma Range

Articolo Article	Quote Dimension			Perni Pins	Descrizione Description
	L	A	B		
144/1	62	31	31	6	Cilindro doppio Double cylinder
144/2	66	31	35	6	
144/3	70	35	35	6	
144/4	71	31	40	6	
144/5	76	31	45	6	
144/6	86	31	55	6	
145/1	41	31	10	6	Mezzo cilindro Single cylinders
145/2	50	40	10	6	

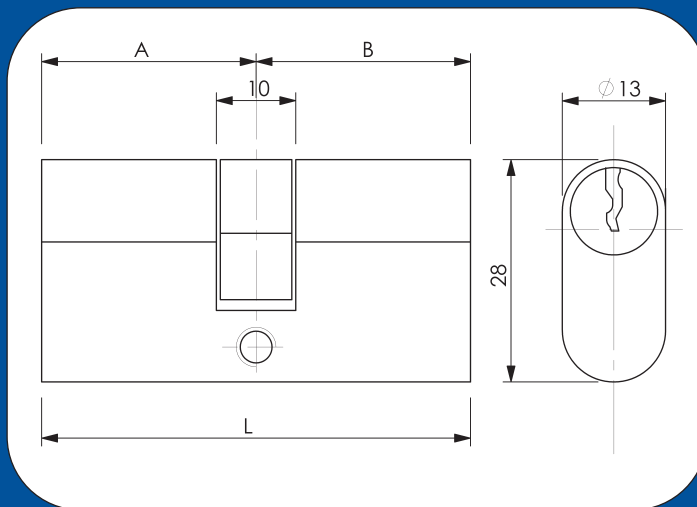

CARATTERISTICHE

Corpo in ottone
Camma standard
3 Chiavi nichelate, in lega d'ottone
Combinazioni con 5 perni

FEATURES

Brass cylinder
Standard cam
3 brass keys
5 biting pins

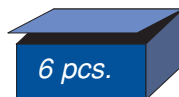
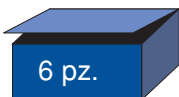

OVALI

La gamma Range

Articolo Article	Quote Dimension			Perni Pins	Descrizione Description	Note Notes		
	L	A	B					
109	54	27	27	5	Cilindro doppio Double cylinder	Camma diritta Standard cam		
109/1	60	30	30	5				
109/2	60	27	33	5				
109/5	70	35	35	5				
109/6	70	27	43	5				
109/9	80	40	40	5				
109/10	80	27	53	5				
151	sporgenza est. 55 mm outside projection 55 mm			5			Mezzo Cilindro Single cylinder	Specifico per Composit Clack artt. 9502/M/L Suitable for Composit Clack artt. 9502/M/L
151/M	sporgenza est. 65 mm outside projection 65 mm			5				
151/L	sporgenza est. 75 mm outside projection 75 mm			5				
150	sporgenza est. 55 mm outside projection 55 mm			5				
150/M	sporgenza est. 65 mm outside projection 65 mm			5	Specifico per Composit e Lampo solo cilindro Suitable for Composit cylinder only version and Lampo			
150/L	sporgenza est. 75 mm outside projection 75 mm			5				
152				5		Specifico per Composit Clack artt. 9502/M/L Suitable for Composit Clack artt. 9502/M/L		

SPILLO

Cilindri con chiave a spillo Cross key cylinders

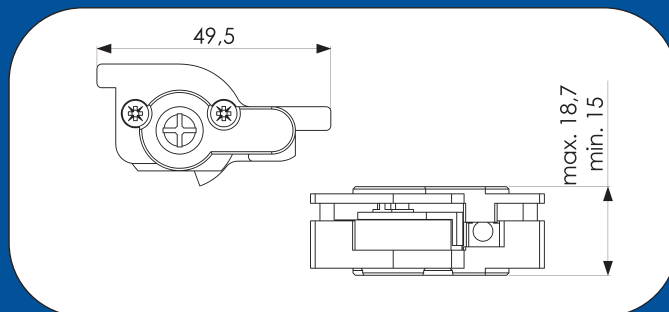

CARATTERISTICHE

Completo di **adattatore per serrature SIMPLY e CONTROL standard** (non servono apposite predisposizioni)
Si applica con la sola vite di fissaggio del normale cilindro (non serve aprire la serratura)
 3 Chiavi nichelate, in lega d'ottone

FEATURES

Adaptor for Simply and Control locks included (no special prearrangement is required)
It can be installed using the fixing screw only (supplied with the cylinder, no need to open the lock)
 3 brass keys

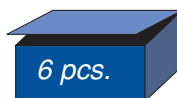
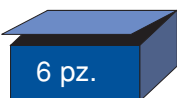

SPILLO

La gamma Range

Articolo Article	Descrizione Description
6808	Cilindro a spillo Cross key cylinder
6808/L	Cilindro a spillo chiave lunga Long cross key cylinder

APPLICARE

Cilindri da applicare Rim cylinders

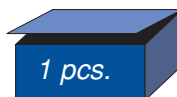
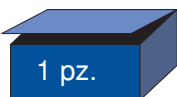

APPLICARE









La gamma Range

Articolo Article	Descrizione Description	
107	Cilindro fisso per Multipla serie 5013 Cylinder for lock 5013	
108	Cilindro fisso per Multipla serie 5014 Cylinder for lock 5014	
112	Coppia cilindri per Multipla serie 5011, 5015, 6001, 6005 Double cylinders for locks 5011, 5015, 6001, 6005	
113	Coppia cilindri per Multipla serie 5012, 5016, 6002, 6006 Double cylinders for locks 5012, 5016, 6002, 6006	
111	Cilindro per maniglie Composit artt. 9520, 9521 Cylinder for handle Composit artt. 9520, 9521	

CHIAVI

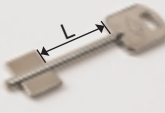
BLANK KEYS



La gamma
Range

Articolo Article	Note Notes	Descrizione Description	Per serrature For locks	
510/D	4 perni	Chiave grezza DX Blank right key	Serrature artt. 525, 550, maniglia Composit art. 9520/1 Locks artt. 525, 550, Composit handle art. 9520/1	
510/S		Chiave grezza SX Blank left key blank		
511	5 perni	Chiave grezza Blank key	Maniglie Millennium / Sprint 19710, 19010/11 e cilindro 190 Millennium/Sprint handles 19710, 19010/11 and cylinder 190	
511/1N	4 perni		Cilindri serie 115N, 116N, 117N Cylinders series 115N, 116N, 117N	
511/2N	5 perni		Cilindri serie 115N, 116N, 117N, 160 Cylinders series 115N, 116N, 117N, 160	
513/D	5 perni	Chiave grezza DX Blank right key	Serrature Multipla Multipla locks	
512	5 perni	Chiave grezza DX Blank key	Cilindri ovali series 109, 150/1/2 Small oval cylinders series 109, 150/1/2	
515/1	4 perni	Chiave grezza Blank key	Cilindri serie 118 Cylinders series 118	
515/2	5 perni			
520	L 35 mm	Chiave grezza doppia mappa Blank double bitted key	Serrature a doppia mappa da incasso Multilever mortise locks	
520/L	L 46 mm			
521	60 mm	Chiave grezza doppia mappa Blank double bitted key	Serrature Segreta Segreta locks	
522	24 mm	Chiave grezza a pompa Blank front key		
526	L 70 mm	Chiave grezza a spillo Blank cross key	Serrature e cilindri a spillo Cross key locks and cylinders	
527	L 50 mm			
544	6 perni	Chiave grezza Blank key	Cilindri RK6 RK6 cylinders	

CILINDRI

CYLINDERS



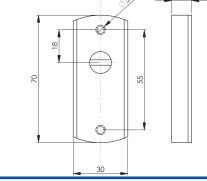
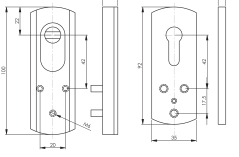



Gli accessori
Accessoires

Articolo Article	Note Notes	Descrizione Description	
112/80	80 mm	Kit prolunga cilindro fisso Extension for fixed cylinders	
112/100	100 mm Tubo + astina +viti Tube +rod+ screws		
112/110	110 mm		
6823	Nera Black	Borchia in nylon Nylon roses	
6823/GR	Grigia Grey		
6823/WH	Bianca White		
6825			
6852/CO	Cromo opaco Matt chrome	Borchia protezione cilindro Security escutcheon	
6852/CS	Cromo satinato Satin chrome		
6852/OL	Ottone lucido Polished brass		
6853/CO	Cromo opaco Matt chrome	Borchia Top protezione cilindro Top Security escutcheon	
6853/CS	Cromo satinato Satin chrome		
6853/OL	Ottone lucido Polished brass		

SPECIALITÀ

SPECIAL KEYING ARRANGEMENTS

La gamma
Range

	KA	MK - GMK - CL	CHIAVE LUNGA
	*	*	
	*		
	*		
	*		*
	*		*
	*		

Nuova F.E.B. è un'azienda che opera seguendo rigorosi standard di qualità, tanto da aver meritato oltre 10 anni fa la certificazione UNI EN ISO 9001. Tale percorso è confermato dal recente ottenimento della **VISION 2000**.

Nuova F.E.B. è specializzata nella realizzazione di serrature, incontri elettrici, maniglioni antipanico e materiali elettrici, apprezzati per innovazione, gamma e qualità.

*The Nuova F.E.B. company follows hard quality standards. As a result, it obtained UNI EN ISO 9001 Certification over 10 years ago. This line is still being pursued, as demonstrated by the recent achievement of the new **VISION 2000**.*

Nuova F.E.B. specialises in the production of locks, electrical strikers, panic bars and electrical materials, known for their innovation, vast range and high quality.



Nuova F.E.B. srl Via Seragnoli, 7
40138 Bologna
Tel. +39.051.6030011
Fax. +39.051.6013781
nuovafeb@nuovafeb.com
www.nuovafeb.com

An ASSA ABLOY Group Company

ASSA ABLOY

The Assa Abloy Group is the world's leading manufacturer and supplier of locking solutions, dedicated to satisfying end-user needs for security, safety and convenience.