

ELECTRIC RIM LOCKS



An **IR** Ingersoll-Rand Company



MAIN FEATURES

A NEW CONCEPT OF SECURITY

- Innovative locking system, with a "rotary hook deadbolt";
- Pull resistance of up to 2000 kg; **A**
- Excellent vibration resistance and impact strength (patented system);
- Protective steel case totally enclosing the lock and the striker.

A REVOLUTIONARY DESIGN

- Elettrika perfectly matches any type of door or gate shape and style.
- The new (patented) design characterised by simple and round lines, represents a true resource for designers.

MAXIMUM VERSATILITY

- Elettrika is non handed (patented system), and with a variable backset from 50 to 80 mm (patented system); **B**
- Elettrika is fitted with a new type of self-adjusting "swinging rod" striker, active both vertically and horizontally (patented system); **C**
- The rotary hook deadbolt of Elettrika can be operated in two different modes (patented system):
 - Automatic opening: the door is set open by the deadbolt rotation;
 - Ready to open: the deadbolt is withdrawn but the door remains in closing position;
- Elettrika is interchangeable with all the types of lock available in the market.

ERGONOMICS

- The innovative reloading system ensures silent opening and closing operation;
- The gate rebound effect is reduced;
- The hold open device (when enabled) allows to block the lock in its open position.

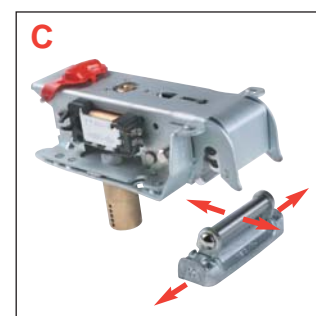
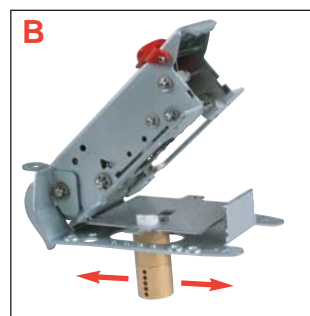
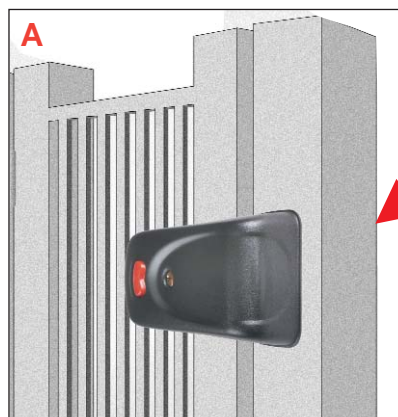

Technical features

- Protective steel casing;
- Rotary hook deadbolt in extruded aluminium;
- Metal striker with stainless steel "swinging rod";
- Zinc coated internal components;
- Power supply: 12 V ac CE.

Operation

- From outside with a key;
- From inside with a push-button or a key plus electric remote control.

Supplied with:

- Striker;
- Single or double cylinder;
- Fixing screws;
- Fixing plates (if required);
- 2 spacers for the striker;
- Instruction sheet;
- 3 keys item 1.01070.10.1

Hand

- Non handed.

Finishes





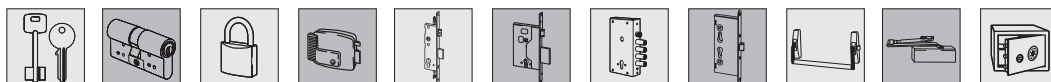

- Epoxy powder paint in dark grey.

Optional accessories

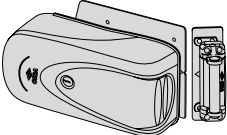
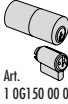
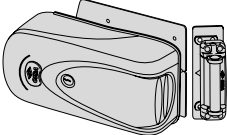
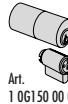
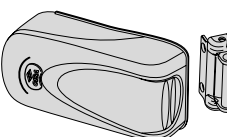
- BOOSTER PLUS item 1.07022.10.0;
- BOOSTER item 1.07022.00.0;
- COIL for BTicino systems item 1.07025.10.0;
- MICROSWITCH item 1.07023.10.0;
- Protective casing for external cylinder item 1.07056.00.0;
- Spacers for striker item 1.07021.01;
- Spacers for long lipped striker item 1.07021.11.0.

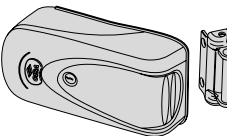

FEI 1
07-05

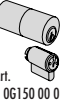
Type	Description	Cylinder	Backset	Unit w. Kg	Pieces	ITEM					
						Type	Dim.	Hand	Fin.	Pers.	Spec.
	<p>VERSION FOR STEEL DOORS</p> <ul style="list-style-type: none"> • Back plate for lock and striker to be welded 		50÷80	2,800	1	1	1A721	00 0			
	<p>VERSION FOR STEEL DOORS</p> <ul style="list-style-type: none"> • Back plate for lock and striker to be welded • Inner push-button • Hold open device 		50÷80	2,800	1	1	1A731	00 0			
	<p>VERSION FOR WOODEN DOORS</p> <ul style="list-style-type: none"> • Inner push-button 		50÷80	2,350	1	1	1A610	00 0			
	<p>VERSION FOR WOODEN DOORS</p> <ul style="list-style-type: none"> • Inner push-button • Brass escutcheon 		50÷80	2,350	1	1	1A611	00 0			
	<p>VERSION FOR WOODEN DOORS</p> <ul style="list-style-type: none"> • Inner push-button • Hold open device 		50÷80	2,350	1	1	1A630	00 0			
	<p>VERSION FOR WOODEN DOORS</p> <ul style="list-style-type: none"> • Inner push-button • Hold open device • Brass escutcheon 		50÷80	2,350	1	1	1A631	00 0			

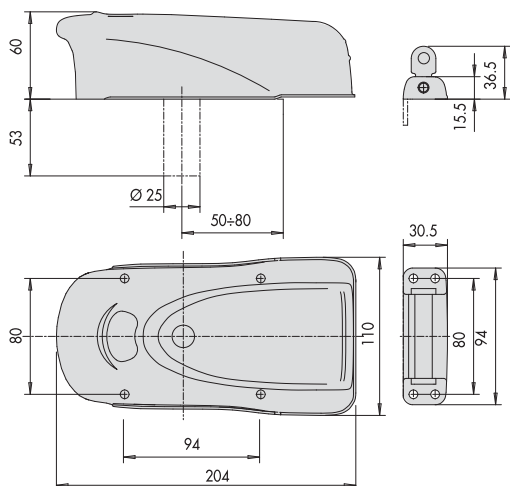

BOOSTER PLUS

FOR USE WITH ELETTRIKA LOCKS



MAIN FEATURES

OPERATION

BOOSTER PLUS comes with a microswitch coil that allows the following functions to be added to the ElettriKa series locks:

- **Timing of the opening command**
BOOSTER PLUS is used to preset an opening time for the ElettriKa series locks. The factory preset opening time is 120 seconds.
This means that once the electric control button is pressed and released, the ElettriKa lock remains powered for the time set and therefore the door/gate can be opened. Once the time set has elapsed, ElettriKa is automatically deprived of power ensuring it safely re-closes. The opening time can be chosen between 4 different values (10-30-60-180 s.)
- **State of door signal**
BOOSTER PLUS provides a signal that is activated each time the door is not securely closed. This signal can be connected to a led or to an alarm system.
- **Electric hold open function**
BOOSTER PLUS also gives an electric hold open function, i.e. to have ElettriKa in a continual operable state by keeping the opening command active beyond the time set by the connection to the terminal board.
- **Voltage adaptor for voltages other than 12 Vac.**
BOOSTER PLUS guarantees proper operation also with voltages of 12 Vdc, 24 V ac, 24 Vdc.
- **Reduced input**
For all those installations where there is a need to have loads with a low current input (for example, interphones with a 250 mA input).
- **Undersized power supply**
BOOSTER PLUS guarantees sufficient power supply to the lock.

INSTALLATION ON ELETTRIKA

- BOOSTER PLUS is installed directly on the frame of ElettriKa; it is hidden beneath its case cover and does not impair the product aspect.



TIMING FUNCTION

DOOR STATE

**ELECTRIC HOLD
OPEN FUNCTION**

Type	Description	Unit w.	Pieces	ITEM			
				Type	Dim.	Hand	Fin.

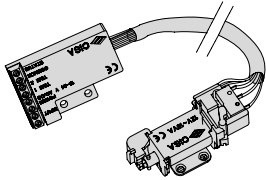

- BOOSTER PLUS can be installed on the Elettrika series locks, in the following cases:
 - Opening command timing, selectable from 5 different times (120 s. factory set time)
 - State of door signal
 - Electrical hold open function
 - Voltage adaptor for voltages other than 12 V ac
 - Reduced current input
 - Undersized power supply
- Standard supply:
 - Plug replacing the anti-repeating effect
 - Fixing screws
 - Instruction sheet

0,185 1 1 07022 10 0

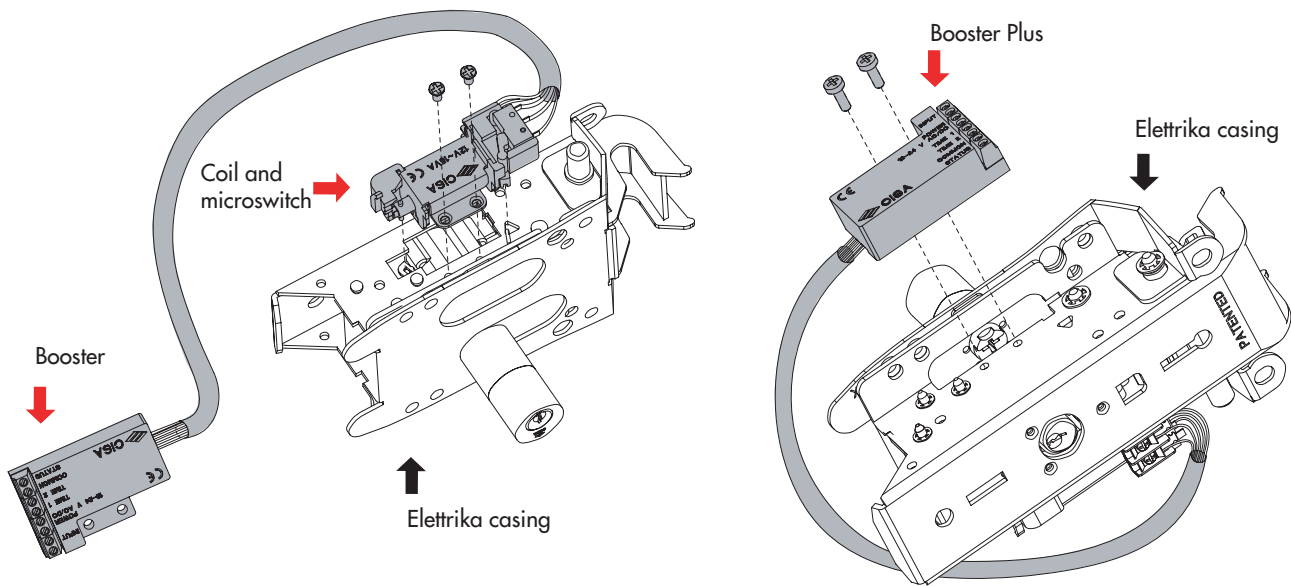

BOOSTER PLUS installation diagram

BOOSTER FOR USE WITH ELETTRIKA LOCKS



An **IR** Ingersoll-Rand Company

MAIN FEATURES

OPERATION

BOOSTER is an electronic circuit that allows the following functions to be added to the ElettriKa series locks:

- **Voltage adaptator for voltages other than 12 Vac**
BOOSTER guarantees proper operation also with voltages of 12 Vdc, 24 Vac, 24 Vdc.
- **Reduced input**
For all those installations where there is a need to have loads with low current input (for example, interphones with a 250 mA input)
- **Undersized power supply**
BOOSTER guarantees sufficient power supply to the lock.
- **Electric hold open function**
By installing a switch parallel to the lock opening button, the lock can be kept in a continual operable state, i.e. "Hold open" (only for ElettriKa).

INSTALLATION ON ELETTRIKA

- BOOSTER is installed on the ElettriKa frame; it is hidden beneath its case cover and does not impair the product aspect.

INSTALLATION ON OTHER ELECTRICALLY OPERATED LOCKS

- BOOSTER can also be installed on other types of electrically operated locks (except strikers), as close as possible to the lock.

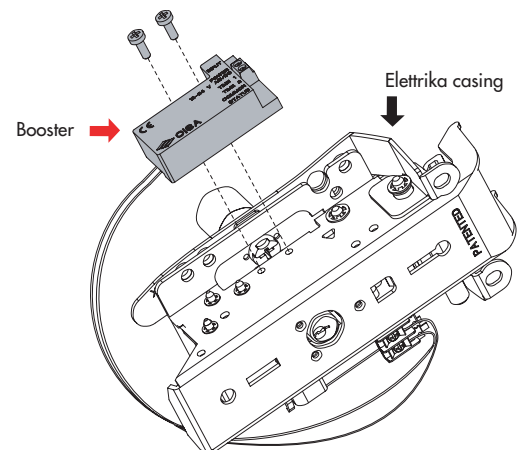

BOOSTER installation diagram

Type	Description	Kg Unit w.	Box Pieces	item				
				Type	Dim.	Hand	Fin.	Pers.

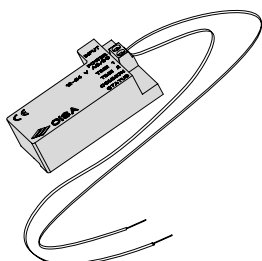

- BOOSTER is installed on the ElettriKa serie locks , in the following cases:
 - Voltage adaptator for voltages other than 12 V ac
 - Reduced current input
 - Undersized power supply
 - Electric hold open function
- Standard supply:
 - Fixing screws
 - Instruction sheet

0,060 6 1 07022 00 0

MICROSWITCH FOR AUTOMATIC GATES FOR USE WITH ELETTRIKA LOCK



An **IR** Ingersoll-Rand Company

MAIN FEATURES

The MICROSWITCH provides a contact that can be used to operate the automatic gate directly with Elettrika, thereby avoiding the installation of a second lock on the column of the gate, generally used to make up for the absence of or a malfunctioning of the remote control.

OPERATION

By rotating the key, both from inside and outside, the lock is released and the MICROSWITCH is then activated, that in turn closes an electric circuit that controls the gate and allows that the lock can directly open it.

The MICROSWITCH provides a contact that can be used also for other purposes, like for example to control the switching on of lights.

INSTALLATION ON ELETTRIKA

The MICROSWITCH is installed on the Elettrika frame; it is hidden beneath its case cover and does not impair the product aspect.

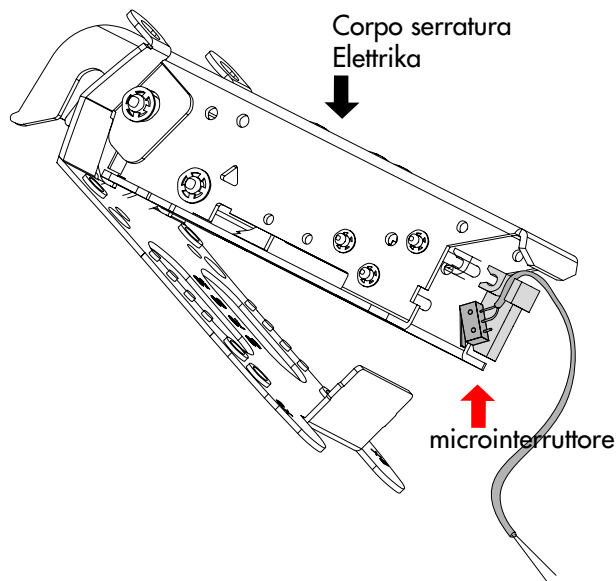

Microswitch installation diagram

Type	Description	Kg Unit w.	Box Pieces	ITEM				
				Type	Dim.	Hand	Fin.	Pers.
		0,007	6	1 07023 00 0				

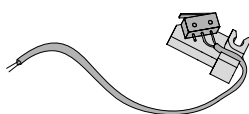

- The MICROSWITCH
 - can be installed directly on Elettrika
 - it provides a contact that can be used for other purposes, like for example to remote control gates or for the switching on of lights.
- Standard supply:
 - Instruction sheet

COIL AND MICROSWITCH FOR BTICINO INTERPHONES AND VIDEO INTERPHONES FOR USE WITH ELETTRIKA LOCKS



An **IR** Ingersoll-Rand Company

MAIN FEATURES

The COIL has a microswitch that allows, together with the interphones/video interphones of the series Swing BTicino:

- digital 2-wire interphone Swing art. 344702-03-04
- digital 2-wire video interphone Swing art. 344802-03-04

to obtain a door state signal for the Elettrika lock (open state). The COIL allows to integrate Elettrika also with the My Home system by BTicino.

OPERATION

- Door state signal
The COIL with microswitch provides a contact that is activated each time the door is not safely closed. A signal led can also be connected to this contact.
- Undersized power supply
The BTicino interphones/video interphones of the mentioned series, are fitted with an electronic circuit that together with the COIL, eliminates any power undersizing problems, guaranteeing sufficient release power.

INSTALLATION

- The COIL is installed directly on Elettrika, replacing the existing coil.
- Electrical connection is achieved using 2 wires.

AVAILABILITY

- Hardware shops (art. CISA 1.07025.10.0)
- Electrical material shops (art. BTicino 346240)

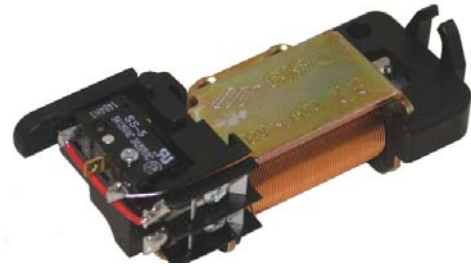

Coil and microswitch installation diagram

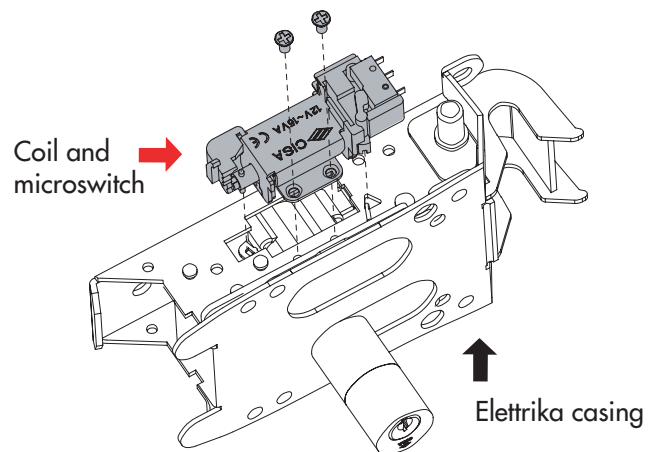

Type	Description	Unit w. Pieces	ITEM					
			Type	Dim.	Hand	Fin.	Pers. Spec.	
		0,092 1	1	07025	10	0		

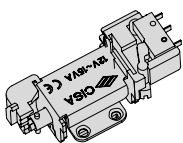

- COIL for BTicino interphones
 - digital 2-wire interphone Swing art. 344702-03-04
 - digital 2-wire video interphone Swing art. 344802-03-04 for use with the Elettrika locks for door state signal.
- Standard supply
 - Fixing screws
 - Instruction sheet

Example of a doorstate signal with an Elettrika lock and a BTicino interphone

