

Q60A

CONTRL UNIT FOR SWING GATE SINGLE OR DOUBLE LEAF 230V

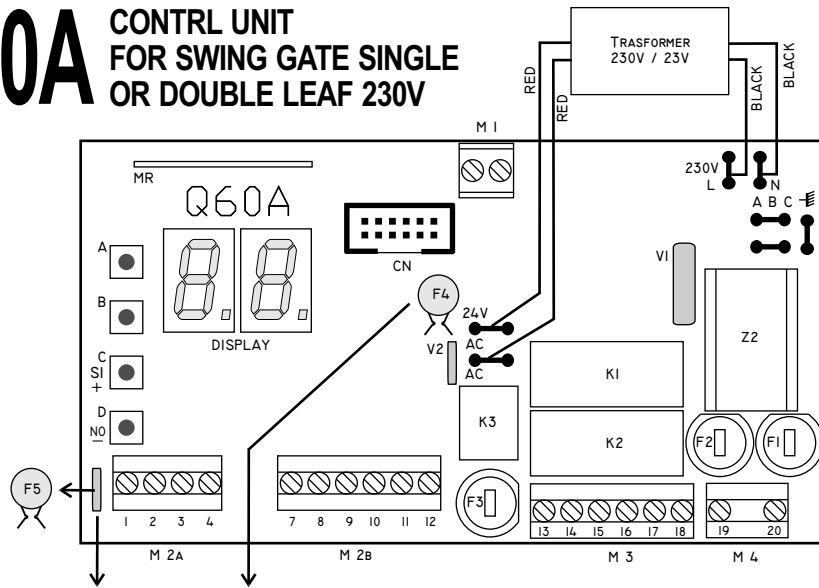

CONTROL UNIT COMPONENTS

- A TOP LEVEL MENU BUTTON
- B LOWER LEVEL MENU BUTTON
- C BUTTON TO INCREASE OR CHANGE TO YES (SI)
- D BUTTON TO DECREASE OR CHANGE TO NO
- F1 230V FUSE 5A
- F2 COCOON FUSES FUSE MOTOR 2 1,6 A
- F3 COCOON FUSES FUSE MOTOR 1 1,6 A
- F4 24V FUSE (SELF-RESTORABLE) 1,6A
- F5 24V FUSE (SELF-RESTORABLE) 0,65A
- DISPLAY 7 SEGMENTS DISPLAY
- M1 RADIO/AERIAL TERMINAL BLOCK
- M2A/M2B CONTROLS AND SAFETY DEVICES TERMINAL BLOCKS
- M3 MOTORS TERMINAL BLOCK
- M4 MAIN POWER TERMINAL BLOCK
- A B C EARTH CONNECTIONS
- MR RADIO UNIT
- CN ELECTROLOCK INTERFACE PCB CONNECTOR
- FILTER
- K1/ K2 MOTORS RELAY
- K3 BLINKER RELAY
- V1 PRIMARY VARISTOR
- V2 SECONDARY VARISTOR

PARAMETERS

B use **button B** to move to next parameter
C use **button C** to **INCREASE** a numeric value or change **NO** to **YES**
D use **button D** to **DECREASE** a numeric value or change **YES** to **NO**
 To save changes and to ensure that they are not lost when power is removed, use **button B** to step through **SU** parameter, the press and hold **button C** until the display reverts to idle display .

SELF-RESTORABLE FUSE 24V

IMPORTANT: IF A TEMPORARY SHORT CIRCUIT OCCURS THE FUSE WILL RESTORE ITSELF AFTER FEW SECONDS.

IN CASE OF A PERMANENT SHORT CIRCUIT, CUT THE MAIN POWER OFF, REMOVE THE TERMINAL BLOCKS 2A AND 2B, WAIT FEW SECONDS AND THEN POWER THE UNIT AGAIN. THE FUSE WILL BE AUTOMATICALLY RESTORED. FIND AND REMOVE THE SHORT CIRCUIT CAUSE BEFORE PLUGGING THE TERMINAL BLOCKS IN.

- BUTTON A** → A ●
CYCLE ROUND THE TOP LEVEL MENU
- BUTTON B** → B ●
MOVE FROM THE TOP LEVEL MENU TO THE LOWER LEVEL MENU
- BUTTON C** → C ●
INCREASE TIME OR CHANGE TO YES
- BUTTON D** → D ●
DECREASE TIME OR CHANGE TO NO

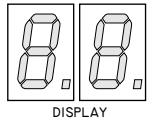

DISPLAY SIGNALS

- A P Opening
- E H Closing
- t P Delay time before automatic Closing

TOP LEVEL MENU

- BUTTON A → -- STAND BY
- BUTTON A → PA PARAMETERS
- BUTTON A → rA RADIO
- BUTTON A → dE DEFAULT
- BUTTON A → AS SEQUENTIAL PROGRAMMING

FUNCTIONS

- BUTTON B → r= SHOW STORED CODES
- BUTTON B → tc NEW REMOTE CONTROL CODE ACQUISITION
- BUTTON B → cP REMOTE CONTROL CODE ACQUISITION WITH STOP FUNCTION
- BUTTON B → Pd REMOTE CONTROL CODE ACQUISITION WITH PEDESTRIAN FUNCTION
- BUTTON B → rC DELETE ALL REMOTE CONTROL CODES

- BUTTON B → rP PRESS & HOLD BUTTON C TO SET DEFAULTS FOR LEADER, ACE OR SHARK.
- ADVANTAGE MOTOR DEFAULTS**
BUTTON B → dS PRESS & HOLD BUTTON C TO SET DEFAULTS FOR ADVANTAGE
- WHEELER DRIVE DAFULTS**
BUTTON B → dr PRESS & HOLD BUTTON C TO SET DEFAULTS FOR WHEELER

DISPLAY FUNCTIONS

- BUTTON B → 1n ONLY 1 MOTOR
- BUTTON B → 2n 2 MOTOR



DISPLAY	TIMES	STANDARD DEFAULT VALUES	ADVANTAGE DEFAULT VALUES	WHEELER DEFAULT VALUES
01	MOTOR 1 WORKING TIME 0 - 99	21	13	9
02	MOTOR 2 WORKING TIME 0 - 99	21	13	9
F1	MOTOR 1 TORQUE 6 - 19	14	10	12
F2	MOTOR 2 TORQUE 6 - 19	14	10	12
Fr	MOTOR POWER DURING DECELERATION 6 - 19	19	19	19
r1	MOTOR 1 DECELERATION TIME 0 - 99	7	4	4
r2	MOTOR 2 DECELERATION TIME 0 - 99	7	4	4
t5	MOTORS' CLOSING DIFFERENTIAL TIME DELAY 0 - 99	3	3	2
5r	MOTORS' OPENING DIFFERENTIAL DELAY TIME 0 - 15	3	3	2
tP	DELAY TIME BEFORE AUTOMATIC CLOSING 0 - 99	3	3	3
Pd	PEDESTRIAN OPENING TIME 0 - 99	7	7	3
tC	LOCK PULSE TIME 0=1/2 SECONDS, 1= 1 SECS. 2=1 1/2 SECS. ETC.....	0	0	0

FUNCTIONS	STANDARD DEFAULT VALUES	ADVANTAGE DEFAULT VALUES	WHEELER DEFAULT VALUES
← BUTTON B → SU PRESS & HOLD BUTTON C TO SAVE CHANGES PRESS BUTTON D TO ABANDON CHANGES	NO	NO	NO
BUTTON B → P8 PHOTOCELLS TEST	SI	SI	SI
BUTTON B → P7 MOTORS TEST	SI	NO	SI
BUTTON B → P6 DECELERATION ON	SI	SI	SI
BUTTON B → P5 ONLY ONE MOTOR	NO	NO	NO
BUTTON B → P4 PRE BLINKING	NO	NO	NO
BUTTON B → P3 AUTOMATIC CLOSING STEP BY STEP	SI	SI	SI
BUTTON B → P2 MULTI OCCUPATION	NO	NO	NO
BUTTON B → P1 ELECTRO LOCK	NO	NO	SI
BUTTON B → P0 REVERSING STROKE	NO	NO	NO

PROGRAMMING THE RADIO

IMPORTANT: BEFORE PROGRAMMING FOR THE FIRST TIME THE RADIO RECEIVER, DELETE ALL THE RECORDED TEST CODES. SEE FUNCTION  AT THE BOTTOM OF THIS CHAPTER



DISPLAYING STORED CODES

Press the **button A** repeatedly until the display shows 
 Press **button B** until the display shows 
 The display will now cycle through each stored code from 01 to 50.



TO ERASE A SINGLE STORED CODE

Press **button D** when the number of the code to be removed is displayed



STORING NEW REMOTE CONTROL CODE

- Press the **button A** repeatedly until the display shows 
- Press **button B** until the display shows 
- Press and hold the remote control button until a dot appears on the display (this means that the receiver is ready to store a new code) and simultaneously press **button C** to store the new code



STORING NEW REMOTE CONTROL CODE with STOP function

- Press the **button A** repeatedly until the display shows 
- Press **button B** until the display shows 
- Press and hold the remote control button until the dot appears on the display and simultaneously press **button C** to store the new code.











STORING NEW REMOTE CONTROL CODE with PEDESTRIAN function

- Press the **button A** repeatedly until the display shows 
- Press **button B** until the display shows 
- Press and hold the remote control button until the dot appears on the display and simultaneously press **button C** to store the new code

DELETING ALL STORED CODES

- Press the **button A** repeatedly until the display shows 
- Press **button B** until the display shows 
- Press and hold **button D** until the display shows 
 This indicates that all the codes have been erased

SELF-DIAGNOSIS DISPLAY MESSAGES

	PHOTOCELL'S TEST ERROR		START SIGNAL (SHORT CIRCUIT BETWEEN TERMINAL 1 & 8)
	OPENING PHASE PHOTOCELL BEAM INTERRUPTED OR WIRING FAULT		RADIO FOB CONTINUOUSLY TRANSMITTING
	CLOSING PHASE PHOTOCELL BEAM INTERRUPTED OR WIRING FAULT		MOTOR 1 PROBLEM (WIRING FAULT, OBSTRUCTION OR TORQUE SETTING TOO LOW)
	BOTH OPENING AND CLOSING PHASE PHOTOCELL BEAM INTERRUPTED OR WIRING FAULT		MOTOR 2 PROBLEM (SEE 'N1' ABOVE)
	STOP PRESSED (OR OPEN CIRCUIT BETWEEN TERMINAL 2 & 8)		BOTH MOTORS PROBLEM (SEE 'N1' ABOVE)
	PEDESTRIAN START SIGNAL (SHORT CIRCUIT BETWEEN TERMINAL 7 & 8)		

PROGRAMMING THE Q36A PARAMETERS

SEQUENTIAL PROGRAMMING (method 2)

Method 1 = STANDARD
 Method 2 = SEQUENTIAL

Warning:

Before powering up and programming the control unit refer to the wiring scheme and then:

- 1 Check that the motor connections are correct
- 2 Check that the photocell connections are correct
Important:
If the photocells are not installed in closing phase, you must link terminals 3 and 9.
If the photocells are not installed in opening phase, you must link terminals 4 and 9.
- 3 Check that the control connections are correct.
Important:
If an emergency stop button is not fitted, you must link terminals 2 and 8.
- 4 Use the motor release key supplied to disengage the electric motor from the mechanical drive; then close the gate and re-engage.
- 5 Power the control unit up

STANDARD PROGRAMMING PROCESS (Method 1)





- a) Give a **START** signal by either turning the key switch or by another control device (terminals 1 and 8)
- b) Wait until the gate has finished a complete (pre-programmed) **OPEN/STOP/WAIT/CLOSE** cycle.
- c) Give another **START** signal and not which parameter need adjusting
- d) Press **button A** on the control unit to select the Parameters menu.
- e) Press **button B** repeatedly until the display shows the parameter that you need to change
- f) Use **buttons C and D** to change or confirm each parameter as necessary
IMPORTANT: press **button B** repeatedly until the display shows  and then press **button C** to save the changes.

Example:







Increase the **Motor 1** working time by **2 seconds**

With the control board switched on, ensure that the display shows: $\rightarrow --$
 Press **button A** (steps thru the top menu) until the display shows $\rightarrow PA$
 Press **button B** (steps thru the sub-menu) until the display shows $\rightarrow n1$
 Wait until the display shows the currents setting, for example $\rightarrow 21$
 Press **button C** twice until the display shows $\rightarrow 23$
 Press **button B** repeatedly until the display shows $\rightarrow 5U$
 Press and hold **button C** until the relays click and the display shows $\rightarrow --$

SEQUENTIAL programming for gates with only one leaf

- a) Press **button A** (steps thru the top menu) until the display shows 
- b) Press **button B** (steps thru the sub-menu) until the display shows 
- c) Give a **START** signal: the leaf starts opening and the display shows 
- d) Wait until the leaf has done the 90% of the opening cycle and then give another **START** signal: the display shows  and the deceleration phase begins
- e) Wait 4/5 seconds after the opening cycle has completely finished and give a **START** signal.
- f) The display shows , the control unit has stored the opening and deceleration times and is now calculating the "**stay open**" time
- g) Give a **START** signal to stop calculating the "**stay open**" time and start the **CLOSING CYCLE**.
- g) When the closing cycle has completely finished, the control unit automatically exits from the sequential programming process and all the working times have been saved.

SEQUENTIAL programming for gates with two leaf

- a) Press **button A** (steps thru the top menu) until the display shows 
- b) Press **button B** (steps thru the sub-menu) until the display shows 
- c) Give a **START** signal:
 The leaf 1 starts opening and the display shows 
- d) Wait until the **leaf 1** has done the 90% of the opening cycle and then give another **START** signal: the display shows  and the deceleration phase of **leaf 1** begins
- e) Wait 4/5 seconds after the **leaf 1** has completely opened and give another **START** signal. The display shows  and the **leaf 2** starts opening
- f) Wait until the **leaf 2** has done the 90% of the opening cycle and then give another **START** signal: the display shows  and the deceleration phase of **leaf 2** begins
- g) Wait 4/5 seconds after the **leaf 2** has completely opened and give another **START** signal.
- h) The display shows , the control unit has stored the opening and deceleration times of both leaves and is now calculating the "**stay open**" time
- i) Give a **START** signal to stop calculating the "**stay open**" time and **start the closing cycle**.
- l) When the **closing cycle** has completely finished, the control unit automatically exits from the sequential programming process and all the working times have been saved.

SPECIAL FUNCTIONS

AUTOMATIC CLOSING FUNCTION

When set to **YES** ("SI"):

- an impulse during the opening phase will stop the motors until another impulse is received
- an impulse during the closing phase will stop and reverse the motors

When set to **NO**, the step-by-step operation is active:

- 1st impulse starts the **opening phase**
- 2nd impulse stops the **opening phase**
- 3rd impulse starts the **closing phase**

MULTI-USER FUNCTION

when set to **YES** ("SI"):

The control unit will not accept any command during the opening phase

TERMINAL BLOCK CONNECTIONS

All the connections must be done without power supply.

TERMINAL BLOCK 1

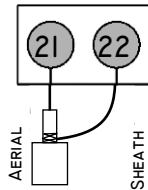

EARTH TERMINAL BLOCK CONNECTIONS

Connect the yellow/green network cable and the yellow/green motor cables to earth terminals **A B C**.

TERMINAL BLOCK 1 CONNECTIONS

21	Aerial or radio receiver signal
22	Sheath or negative for radio receiver

TERMINAL BLOCK 2 CONNECTIONS

1-8	Start control normally open (NA) for button, key selector, radio receiver or Timer clock connections. The Start control starts the programmed running cycle.
2-8	Stop control normally closed (NC). Emergency button. <i>When pressed the gate stops immediately.</i> In opening phase: at the first impulse the gate closes. Break-time: at the first impulse the gate closes In closing phase: at the first impulse the gate opens. If temporarily the Stop contact is not used, link terminal 2 with terminal 8.
3-8	Input of one safety photocell in closing phase. Input of safety rubber edges and of safety photocell in closing phase. Input of several safety photocells in closing phase. The receiver contacts must be connected in series. Normally closed (NC). In opening phase: does not work In closing phase: Stop, break-time for 2 seconds, opening phase again. If temporarily the photocell contacts are not used, link terminal 3 with terminal 9.
3-9	Input only for safety rubber edges in closing phase. The contacts must be connected in series if there is more than one safety rubber edge. Normally closed (NC). In opening phase: does not work. In closing phase: Stop, break-time for 2 seconds, opening phase again.
4-8	Input for safety photocells in opening phase (for swing gate). Normally closed (NC). In opening phase: Stops until the obstacle has not been removed In closing phase: Stops and changes direction when the obstacle has been removed If you also want to connect the safety rubber edges, you must connect in series their contacts with the photocell ones. If temporarily the photocell contacts are not used, link terminal 4 with terminal 9.
4-9	Input for safety rubber edges in opening phase (for swing gate). Normally closed (NC). In opening phase: Stops until the obstacle has not been removed In closing phase: Stops and changes direction when the obstacle has been removed The contacts should be connected in series.
7-8	Pedestrian start input. Normally open (NA).
8-10	Output for photocell receiver power supply. Output for extra 24V dc accessories power supply. With all Standard accessories included 100 mA are still available for extra accessories.
9-10	Output for photocell transmitter power supply.
11-12	Blinker intermittent output. 24V 20W max.

TERMINAL BLOCK 3 CONNECTIONS

13	Motor M1- output (13 Brown; 14= Blue; 15= Black)
14	Leaf that opens firstly and that delays in closing phase.
15	In case of a gate of one single leaf connect the motor to output M1 , select parameter <i>P 5</i> on SI, confirm with <i>5 U</i> and save with push button C . CAPACITOR between terminal 13 and 15
16	Motor M2- output (16=brown - 17=Blue - 18= Black)
17	Leaf that opens secondly.
18	CAPACITOR between terminal 16 and 18

TERMINAL BLOCK 4 CONNECTIONS

19-20	Power input 230-240 Vac - 50/60 Hz. (19=Neutral - 20=phase)
-------	---

TERMINAL BLOCK 2A

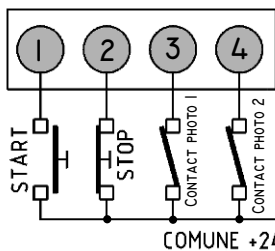

TERMINAL BLOCK 2B

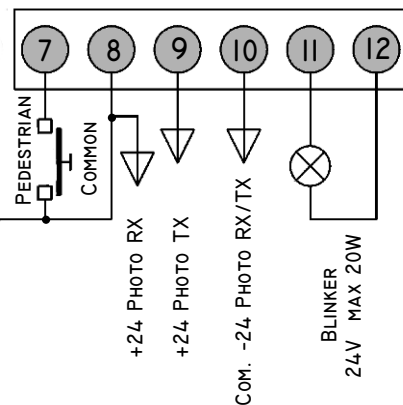

TERMINAL BLOCK 3

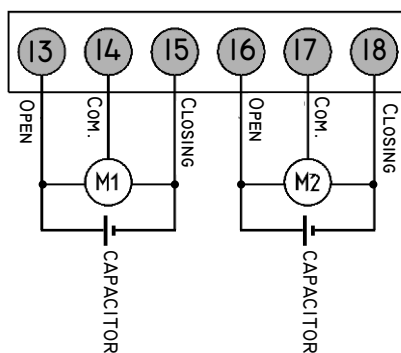

TERMINAL BLOCK 4

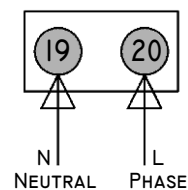

WIRING SCHEME FOR THE Q60A CONTROL UNIT

1 START

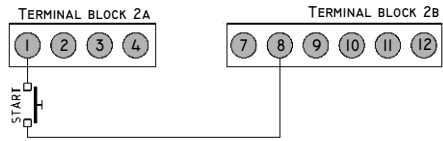

2 PEDESTRIAN START

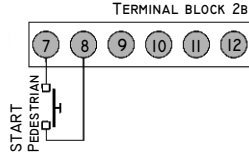

3 PERMANENT START COMMAND WITH TIMER

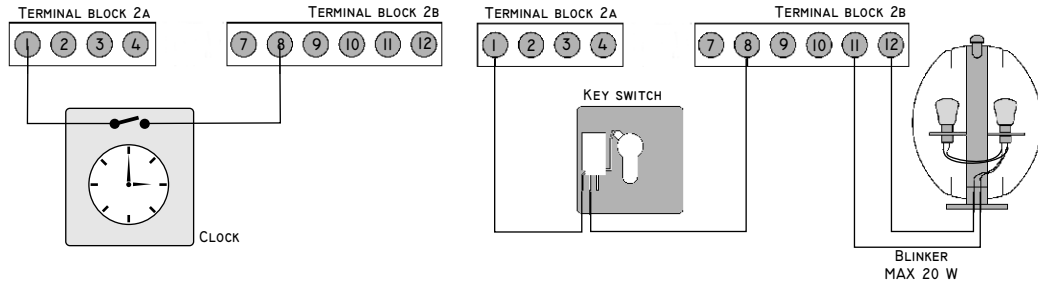

4 EMERGENCY STOP BUTTON

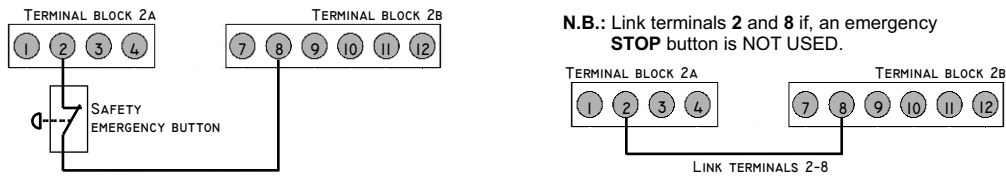

5 MOTORS CONNECTIONS

MOTOR 1

Leaf with electro-lock and/or leaf that opens first
 13 OPEN = BROWN motor wire + WHITE Capacitor wire
 14 COMMON = BLUE or GREY motor wire
 15 CLOSE = BLACK motor wire + WHITE capacitor wire

MOTOR 2

Leaf that opens second
 16 OPEN = BROWN motor wire + WHITE Capacitor wire
 17 COMMON = BLUE or GREY motor wire
 18 CLOSE = BLACK motor wire + WHITE capacitor wire

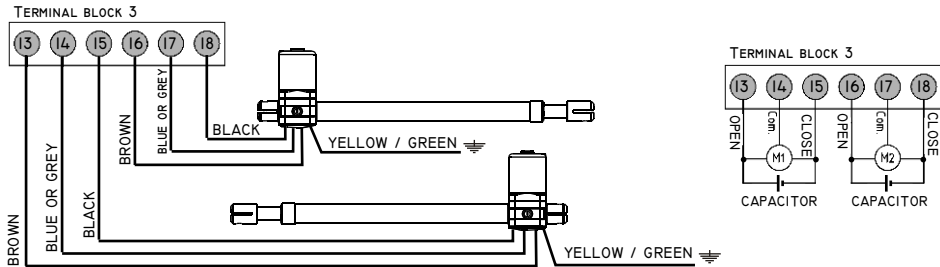

CONNECTIONS IF ONLY ONE MOTOR

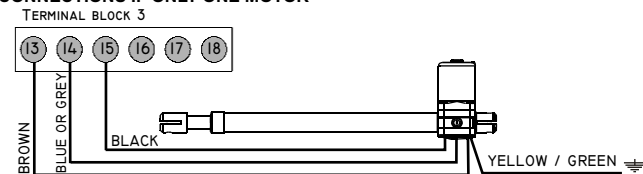

6 CONNECTING PHOTOCELL IN CLOSING PHASE

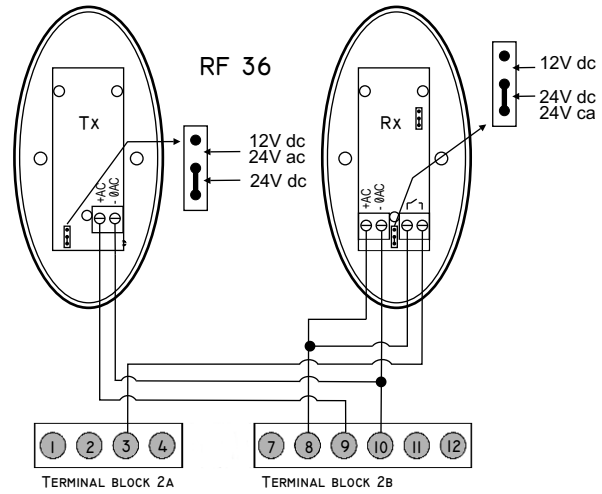

PHOTOCELLS CONNECTIONS

8 = Power supply + PHOTO RX
 9 = Power supply + PHOTO TX
 10 = Power supply - COM. PHOTO TX/RX
 3 - 8 = Photocells connection

3 - 9: Link terminals 3 and 9 if the photocells are not used in the closing phase.

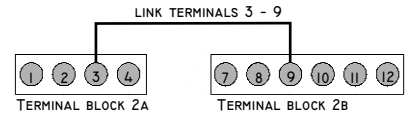

CONNECTING PHOTOCELL IN OPENING PHASE

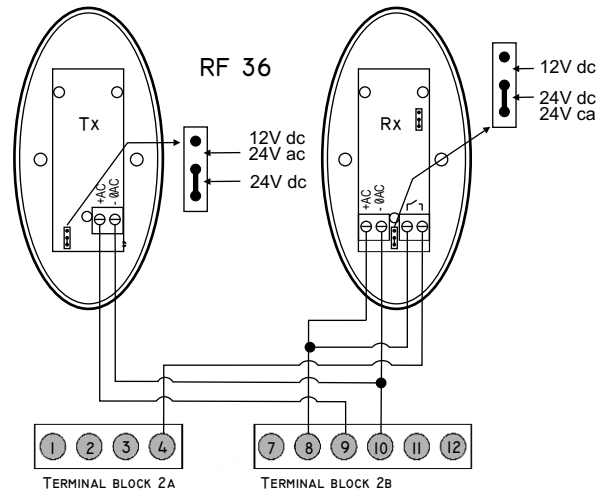

PHOTOCELLS CONNECTIONS

8 = Power supply + PHOTO RX
 9 = Power supply + PHOTO TX
 10 = Power supply - COM. PHOTO TX/RX
 4 - 8 = Photocells connection

4 - 9: Link terminals 4 and 9 if the photocells are not used in the opening phase.

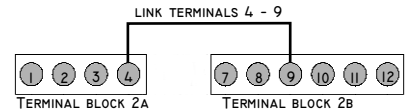

7 ELECTRO-LOCK INTERFACE BOARD (MEL)

IF YOU WANT TO CONNECT THE MEL INTO CN

- CONNECT THE ELECTRO LOCK
- CHANGE THE PARAMETERS $P0 - P1$ AND t_c

