

SAMSUNG



## Digital Video Recorder **SVR-1670** User Guide

Before installing and operating this product,  
please read this manual thoroughly.

ENGLISH  
Firmware Version 1.2

## Product Warranty and Limits of Responsibility

Samsung does not accept any other responsibility concerning the sale of this product and does not delegate any right to a third party to take any responsibility on its behalf. Product warranty does not cover accident, negligence, alteration, misuse or abuse. In addition, no warranty is offered for any attachments or parts not supplied by the manufacturer.

The warranty period for this product is three (3) years from the date of purchase. The warranty period for HDD and Fan is one year after purchase.

The following are not covered by the warranty:

- Malfunction due to negligence or improper handling by user
- Deliberate disassembly and replacement by user
- Connection to an improper power supply
- Malfunction caused by natural disasters (fire, flood, etc.)
- Replacement of expendable parts (HDD, Fan, etc.)
- Replacement of expendable parts using ones from an unauthorized third party

Warranty only refers to the warranty covering products that have been purchased. During the warranty period, repair and examination of items outside the warranty scope will be provided for a fee. After the warranty period expires, examination and repair of the product will be provided for a fee.

This product is not intended to be the primary means for preventing fire and theft. The company is not responsible for any accidents or damage that may occur as a result of using this product.

Prior experience and technical expertise is required to install the product. Installing the product without proper knowledge can cause fire, electric shock, or other damage. Installation should be performed by the agency from which you purchased the product.

Samsung may implement, without prior notice, firmware or software upgrades or changes to the appearance of the product.

Copying and reprinting this manual, either partially or in its entirety, or translating it into another language without the consent of Samsung Techwin, Inc. is prohibited. Copying for general use is acceptable if within copyright law.

## Table of contents

Product Warranty and Limits of Responsibility .....	2
Table of contents .....	3
Chapter 1. About Safety, Compliance and Disposal .....	5
1. 1 Warnings .....	5
1. 2 Cautions .....	6
1. 3 Compliance Statements .....	6
1. 4 Disposal Procedures .....	7
Chapter 2. SVR-1670 Description .....	7
2. 1 About the SVR .....	8
2. 2 Features .....	8
2. 3 Package Contents .....	10
2. 4 Front Panel Overview .....	11
2. 5 Rear Panel Overview .....	13
2. 6 The Remote Control .....	14
Chapter 3. Hardware Installation .....	17
3. 1 Installing the SVR-1670 in a Rack .....	18
3. 2 Working with Input/Output Terminals .....	18
3. 3 Basic Connections to the SVR-1670 .....	19
3. 4 Extended Connections to the SVR-1670 .....	25
3. 5 Remote Monitoring and Control .....	31
3. 6 Hard Disk Drive Installation .....	32
Chapter 4. Navigation: On-Screen Display and Function Menus .....	38
4. 1 Working with the On-Screen Display .....	38
4. 2 Working with the Function Key Menu .....	42
Chapter 5. Quick Setup .....	44
5. 1 Working on the Quick Setup Menu .....	44
5. 2 Setting the Record Mode .....	45
5. 3 Setting the Date and Time .....	46
Chapter 6. Using the System Setup Menu .....	47
6. 1 Using the System Setup Options .....	47
6. 2 Using the Disk Options on the System Setup Menu .....	50
6. 3 Working with Passwords and Permissions .....	52
Chapter 7. Communication To / From the DVR .....	55
7. 1 Setting up Network Communication .....	55
7. 2 Registering with a DDNS Server .....	58
7. 3 Setting up for NTP Synchronization .....	62
7. 4 Configuring Remote Control .....	63
7. 5 Setting up IP Filters .....	65

# Table of contents

<b>Chapter 8. Working with Events</b> .....	<b>66</b>
8. 1 About Events .....	66
8. 2 Setting Up for Event Recording .....	66
8. 3 Working with Normal Events .....	69
8. 4 Working with Presets .....	72
8. 5 Working with Digital I/O .....	72
8. 6 Defining Programs .....	74
8. 7 Setting Up To Record .....	76
<b>Chapter 9. Camera and Monitor Display Setup</b> .....	<b>80</b>
9. 1 Setting Up the Camera Display .....	80
9. 2 About Multichannel Screen Display .....	81
9. 3 Setting Up the Monitor Display .....	82
9. 4 Using Auto Sequencing .....	82
9. 5 Configuring Multi Display Layouts .....	84
9. 6 SPOT Monitor Settings .....	84
<b>Chapter 10. Camera Commandss</b> .....	<b>85</b>
10. 1 Camera Commands from the FUNC Key Menu .....	85
10. 2 Pan/Tilt/Zoom Commands .....	85
<b>Chapter 11. Working with Recorded Video</b> .....	<b>88</b>
11. 1 Various Playback Options .....	88
11. 2 Searching for Recorded Video .....	89
11. 3 About Copying Video .....	92
<b>Chapter 12. Using Web Viewer</b> .....	<b>94</b>
12. 1 System Requirements .....	94
12. 2 Starting Web Viewer .....	94
12. 3 Monitoring .....	95
12. 4 Playback .....	98
<b>Appendix A. Specifications of the SVR-1670</b> .....	<b>100</b>
<b>Appendix B. Recording Program Default Settings</b> .....	<b>102</b>
<b>Appendix C. Supported PTZ Controllers and Protocols</b> .....	<b>104</b>
<b>Appendix D. Compatible HDD List</b> .....	<b>105</b>
<b>Appendix E. Compatible Media List</b> .....	<b>105</b>
<b>Appendix F. Factory Default Settings</b> .....	<b>106</b>
<b>Appendix G. Glossary</b> .....	<b>116</b>
<b>Dimension</b> .....	<b>121</b>

# Chapter 1. About Safety, Compliance and Disposal

This chapter explains important information about the safe use of the SVR-1670, its compliance to FCC and ECO RoHS regulation, and how to properly dispose of the equipment.

The information is presented in these sections:

- 1. 1 Warnings
- 1. 2 Cautions
- 1. 3 Compliance Statements
- 1. 4 Disposal Procedures

## 1. 1 Warnings

Samsung Techwin, although not responsible for accidents or damage that might occur as a result of using this SVR-1670, wants you to use it wisely and safely. In this section, we provide several warnings you should follow before installing the equipment, during operation, and if dismantling or cleaning the equipment.



Heed these warnings to prevent serious injury, shock or death.

### • Before installation

To avoid fire, explosion, malfunction or electric shock, observe these practices:

- Disconnect the power supply before installation.
- Verify that you can install to correct voltage(AC100V~AC240V) before connecting to a power supply.
- Never install in a very humid environment.
- Properly ground the SVR-1670 as well as any equipment you are connecting to it.

### • During operation

To avoid fire, explosion, malfunction or electric shock, observe these practices :

- If the SVR-1670 cover ever needs to be opened, rely on qualified personnel or system installers, who know how to do this safely.
- Never plug multiple appliances into a single power outlet.
- Never place heavy objects or dishes holding water on this product.
- Never use the SVR-1670 where excessive dust or flammable substances such as propane gas are present.
- Never touch power line with wet hand.
- Never insert hand into the DVD dock.
- Never put conductive materials into the cooling ventilator opening.
- Never apply excessive force when pulling on the power cord.
- Replace built-in battery with same battery type. Dispose of old batteries properly
- Never place batteries near fire or extreme heat.
- Never dissect or disassemble batteries.

### • Dismantling and Cleaning

- Use a dry cloth to clean the exterior.
- Never use water, paint thinner or organic solvent to clean the product exterior.
- Never deliberately dismantle, repair or modify product.

# Chapter 1. About Safety, Compliance and Disposal

## 1. 2 Cautions

Samsung Techwin, although not responsible for accidents or damage that might occur as a result of using this product, wants you to use it wisely and safely. In this section, we provide several cautions you need to follow before installing or operating the equipment.



Heed these cautions to prevent minor injury to users or damage to the equipment. You will see other cautions throughout this manual. Cautions are indicated by the exclamation point symbol.

### • During Installation

Prevent accidents and avoid injury or malfunction, observe these practices :

- For adequate ventilation, install the SVR-1670 with at least 6 in (15cm) of space between cooler fan and wall surface.
- Install on a flat surface.
- Never install in areas exposed to direct sunlight or excessive heat.
- Connect a camera to the SVR-1670 before recording and storing images. (If a camera is installed while SVR-1670 is recording, the image in another channel might be disrupted.)
- This equipment is indoor use and all the communication wirings are limited to inside of the building.

### • During Use

- Never expose the SVR-1670 to shocks or shaking during use.
- Never move, throw or expose to excessive physical shock during use.
- Installing unapproved hard disk drives can result in abnormal operation. Use only approved products. The SVR-1670's product warranty does not cover malfunction due to installation of unapproved hard disk drives.
- Samsung Techwin recommends the installation of a UPS (Uninterrupted Power Supply) with all its recording products.

## 1. 3 Compliance Statements

### • FCC Compliance Statement

This equipment has been tested and found to comply with the limits for a Class A digital device, pursuant to part 15 of the FCC Rules. These limits are designed to provide reasonable protection against harmful interference when the equipment is operated in a commercial environment. This equipment generates, uses, and can radiate radio frequency energy and, if not installed and used in accordance with the instruction manual, might cause harmful interference to radio communications. Operation of this equipment in a residential area is likely to cause harmful interference in which case the user will be required to correct the interference at his expense.

### • ECO RoHS Compliance



Samsung Techwin cares for the environment and strives to preserve it during all product manufacturing stages and to provide customers with environment-friendly products. The Eco mark represents Samsung Techwin's goal to create environment-friendly products and indicates that the product satisfies the EU RoHS Directive.

## 1. 4 Disposal Procedures

The following procedures are applicable in the European Union and other European countries to comply with correct disposal of waste electrical and electronic equipment, and batteries.

### • Correct Disposal of Waste Electrical and Electronic Equipment



This marking, shown on the product or its literature, indicates that it should not be disposed of with other household wastes at the end of its working life. To prevent possible harm to the environment or human health from uncontrolled waste disposal, please separate this from other types of wastes and recycle it responsibly. Household users should contact either the retailer where they purchased this product, or their local government office, for details of where and how they can take this item for environmentally-safe recycling. Business users should contact their supplier and check the terms and conditions of the purchase contract. This product should not be mixed with other commercial wastes for disposal.

- **CAUTION** : Risk of Explosion if Battery is replaced by an Incorrect Type. Dispose of Used Batteries According to the Instructions.

### • Correct Disposal of Batteries



This marking on the battery, manual or packaging indicates that the batteries in this product should not be disposed of with other household waste at the end of their working life. Where marked, the chemical symbols Hg, Cd or Pb indicate that the battery contains mercury, cadmium or lead above the reference levels in EC Directive 2006/66. If batteries are not properly disposed of, these substances can cause harm to human health or the environment. To protect natural resources and to promote material reuse, please separate batteries from other types of waste and recycle them through your local, free battery return system. The rechargeable battery incorporated in this product is not user-replaceable. For information on its replacement, please contact your service provider.

# Chapter 2. SVR-1670 Description

This chapter provides information about the Samsung SVR series SVR-1670 (digital video recorder) and contains a description of SVR parts and accessories.

The information is presented in these sections:

- 2. 1 About the SVR-1670
- 2. 2 Features
- 2. 3 Package Contents
- 2. 4 Front Panel Overview
- 2. 5 Rear Panel Overview
- 2. 6 The Remote Control

## Chapter 2. SVR-1670 Description

### 2. 1 About the SVR

The SVR-1670 in the Samsung SVR series records and plays video from up to 16 channels. In addition, the SVR can alert you of the occurrence of user-defined events, such as motion detection, using the buzzer, on the screen, or via e-mail. Various methods are provided to configure and control this product: the front panel control board, mouse, remote controller, Web Viewer, SVM-S1 (CMS: Centralized Management Software), and controller.

Recorded high-quality video files are saved in the hard disk drive for search and play purposes. You can record, play, and copy video files from multiple channels in real time. This SVR provides a variety of advanced options: motion detection, PTZ controls (Pan/Tilt/Zoom), user permission settings and access control, real-time audio recording, event logging and search.

### 2. 2 Features

The various features of the SVR-1670 are discussed below and include:

- Monitoring Screen
- Video Recording
- Audio Recording
- Search and Playback
- Data Storage
- Networking
- Additional Features

#### • Monitoring Screen

The monitoring screen provides vivid, high-definition live video feeds from all 16 channels. On the split-screen, you can view 4, 9, 10, or 16 channels as well as single-channel display. To facilitate viewing, an auto-sequencing feature automatically switches to each connected channel after a set interval.

- To the SVR-1670, two composite monitors and a single VGA monitor can be connected.

#### • Video Recording

The SVR-1670 stores video image data as high-resolution H.264 files at a maximum rate of 480 frames per second. When recording video based on events, pre-event video of up to five seconds is also recorded. With an advanced "covert" feature, the SVR-1670 protects the public's privacy by selected channels.

To effectively manage the data storage capacity of the SVR, you can adjust its recording performance using software that defines the resolution, frame rate, and recording quality.

Motion detection settings, recording rates and recording modes can be programmed for each channel individually.

The SVR-1670 provides several recording functions to accommodate any combination of manual and scheduled recording. Along with multiple recording modes, users can perform all of the following functions simultaneously: view recorded video, record video, backup video to the hard disk or external storage media, and monitor and perform other networking operations.

An event log stores information on all event sensor activity, digital input/output activity, video loss detection, and text-based transactions.

#### • Audio Recording

The SVR-1670 supports real-time audio input and recording for 16 channels simultaneously. Four RCA channels and 12 D-SUB Channels are provided on the rear panel along with one audio output channel. Audio can be recorded and played back simultaneously.

#### • Search and Playback

Search and playback options on the SVR-1670 include support for playback based on time, date and channel, a graphical interface to input data search criteria, forward and backward search of paused video, playback logs for all events, full frame playback, and access to search functions from the remote control or the front panel JOG/SHUTTLE.

#### • Data Storage

A hard disk is included with the product for data storage. The recorded data also can be stored to external media such as a DVD+R, DVD-R, CD-R or USB.

Used in conjunction with the internal 8 TB storage and 4 TB external E-SATA (SVS-5R), up to 12 TB of storage is available.

#### • Networking

The SVR-1670 supports LAN, xDSL networking capabilities across a 10/100/1000 Mbps Ethernet connection. Several SVR-1670s can be connected across a network. Combined with the PC interface client, the core features of the device can easily be controlled remotely. A network connection is required for the following features:

- E-mail notification of events, which can be sent via TCP/IP or DHCP
- Using Web Viewer, monitor video from a remote location in real time and play recorded video.
- Running the SVM-S1 to search for and play back recorded video, manage storage devices, set up recording schedules, and control the SVR-1670 remotely

#### • Additional Features

The following features are also available on the SVR-1670 :

- 18-language OSD: Korean, English, Japanese, Chinese, Taiwanese, Spanish, French, Italian, German, Portuguese, Polish, Turkish, Russian, Swedish, Danish, Serbian, Rumanian, and Czech)
- Easy firmware upgrade via USB or over the network.  
(Firmware upgrading via network is not available during playback of recorded video.)
- PTZ control and Preset function

# Chapter 2. SVR-1670 Description

## 2.3 Package Contents

Refer to the package contents diagram to ensure that all accessories are provided with your SVR-1670.

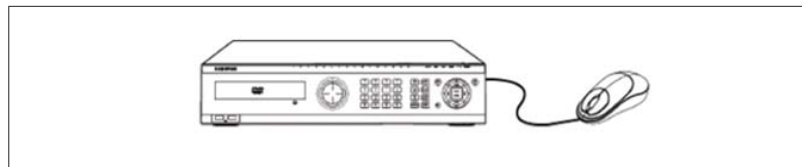

Figure 2.3.1 Package Contents – SVR-1670 and Mouse









<p>AC CORD</p> 	<p>Remote controller</p> 	<p>Program CD</p> 
<p>SATA Cable</p> 	<p>HDD Mount Screw</p> 	<p>SVR-1670 Quick Guide / SVR-1670 User's Guide</p> 
<p>Quick Guide</p> 	<p>Rack Mount</p> 	<p>Mouse</p> 

Figure 2.3.2 Package Contents Diagram

## 2.4 Front Panel Overview

The front panel of the SVR-1670 has the following controls and indicators:

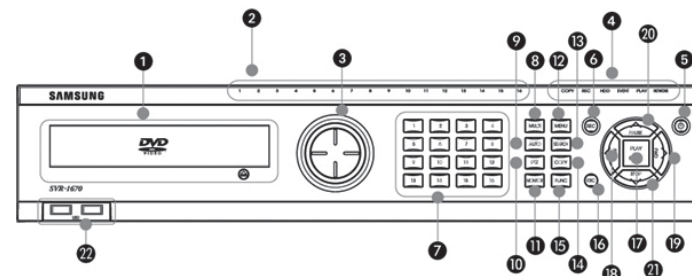

Figure 2.4.1 SVR-1670 Front Panel

No.	Name	Function
1	DVD-Multi drive	Copies recorded video and images to DVD or CD-ROM optical media.
2	Channel LED	Shows data input and event operation status for each attached camera.
3	JOG/SHUTTLE	Use the jog dial to search recorded video precisely per frame. The shuttle can be used to change the play speed while playing or searching video, forward or backward.
4	COPY light	Lit when copying.
	REC light	Lit when the unit is recording.
	HDD light	Lit when the hard disk is active.
	EVENT light	Lit to indicate event detection.
	PLAY light	Lit during playing of video.
5	NETWORK light	Lit during network activity.
	Power button	Turns SVR-1670 on or off.
6	REC button	Starts or stops manual recording.
7	Channel button	Selects the channel to view live or playback video.
8	MULTI	Changes split-screen sections for live video feeds or playback.

## Chapter 2. SVR-1670 Description

9	AUTO	Starts or stops user-defined sequences.
10	PTZ	Starts or stops a PTZ function.
11	MONITOR	Switches between the main and spot monitors.
12	MENU	Opens the on-screen display menu.
13	SEARCH	Starts Search mode.
14	COPY	Starts Copy mode.
15	FUNC	Starts Function mode.
16	ESC	Each time pressed, closes open submenus and menus.
17	PLAY/ENTER	Starts playback or selects an item on the menu.
18	◀/REW	Goes to or selects in the menu. For playback, changes the reverse playback speed.
19	▶/FFW	Goes to or selects in the menu. For playback, changes the forward playback speed.
20	▲/PAUSE	Goes to or selects in the menu. For playback, pauses live or recorded video.
21	▼/STOP	Goes to or selects in the menu. For playback, stops playback.
22	USB1, USB2	USB ports for external devices (mouse, USB memory stick).

### 2. 5 Rear Panel Overview

The rear panel of the SVR-1670 has the following connections:

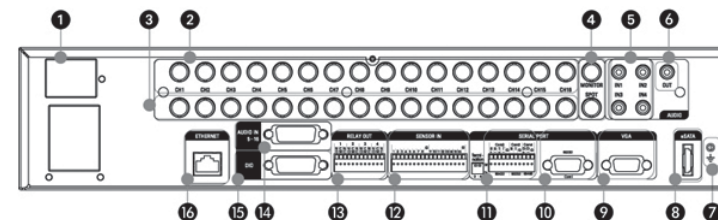

Figure 2.5.1 SVR-1670 Rear Panel

No.	Terminal Name	Function
1	Power Input	Socket for AC 100V ~ AC 240V power cord
2	Ch1 ~ 16	Connection terminal for camera BNC input
3	Loop Out	Connection terminal for camera BNC output (loop)
4	Monitor 1~2	Connection terminal for monitor BNC output
5	Audio In (RCA)	RCA audio jack for RCA input
6	Audio Out	Audio jack for speaker output
7	Ground	A terminal that is used to ground SVR-1670 main frame.
8	eSATA	Connection terminal for an eSATA external storage device.
9	VGA Output	Output port for PC monitor
10	Serial Port	RS-232C D-SUB connector
11	Serial Port (Terminal Block) (RS-232C/485/422)	Connection terminal for expanded control, speed dome camera, and other such equipment.
12	Sensor In	Connection terminal for sensor input
13	Relay Out	Connection terminal for relay output
14	Audio In (D-SUB)	D-SUB connection terminal for audio inputs from channel 5 to 16
15	D-I/O	Connection terminal for Digital In/Out
16	Ethernet	Ethernet port for network connections (RJ-45)

## Chapter 2. SVR-1670 Description

### 2. 6 The Remote Control

You can control all SVR-1670 features using the remote control device. You can also control multiple SVR-1670s from one remote control device. This section explains how in these topics :

- Buttons on the Remote Control.
- Setting Unit SVR-1670 IDs.
- Usable Range of Remote Control.
- Changing Batteries.

#### Buttons on the Remote Control

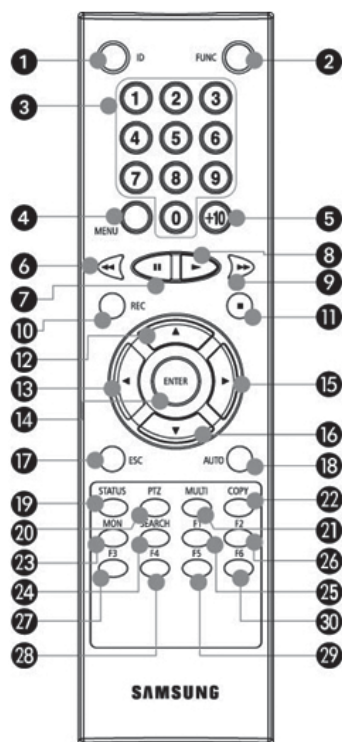

Figure 2.6.1 Remote Control

No.	Name	Function
1	ID	Selects the unique ID.
2	FUNC	Starts Function mode.
3	Channel buttons	Changes channels.
4	MENU	Switches to the on-screen display menu.
5	+10	Use this button to select a channel number from 10 to 16; for Channel 16, press +10 and then 6.
6	FAST REWIND (◀◀)	Fast reverses playback.
7	PAUSE (  )	Pauses playback.
8	FORWARD PLAY (▶)	Forwards playback.
9	FAST FORWARD (▶▶)	Fast forwards playback.
10	RECORD (●)	Starts and stops manual recording.
11	STOP (■)	Stops playback.
12	▲	Moves cursor up in the OSD menu.
13	◀	Moves cursor left in the OSD menus.
14	↵ (Enter)	Saves settings and executes a function.
15	▶	Moves cursor right in the OSD menus.
16	▼	Moves cursor down in the OSD menus.
17	ESC	Cancels settings or goes up in the menu.
18	AUTO	Switches to automatic display mode.
19	STATUS	Displays system setup information.
20	PTZ	Switches to PTZ mode.
21	MULTI	Changes split-screen sections for live video or playback.
22	COPY	Starts Copy mode.
23	MON	Switches between the main and spot monitors.
24	SEARCH	Displays the Search menu.
25~30	F1~F6	Reserved for future use.



## Chapter 2. SVR-1670 Description

### Setting the SVR-1670's ID for the Remote Control

You can control up to 16 SVR-1670s from one remote control by creating unique IDs for each SVR-1670.

#### • Setting the ID for the remote control device



Figure 2.6.2 Remote Control ID

1. From the OSD, select the Network menu.
2. Select the Remote sub-menu.
3. For the Remote Controller ID option, select an ID value. This will become the ID for the remote device you plan to use.

#### • Setting the ID for the remote control device

Press the ID button on the remote controller and then the Channel button corresponding to the ID of the DVR. If the selection is successful, the DVR plays a beep and you can remote control the SVR-1670. To select an ID from 10 to 16, press +10 on the remote controller before the Channel button.

### Usable Range of Remote Control

Figure 2.6.3 shows an angle when the remote controller is pointed to the DVR remote controller receiver.

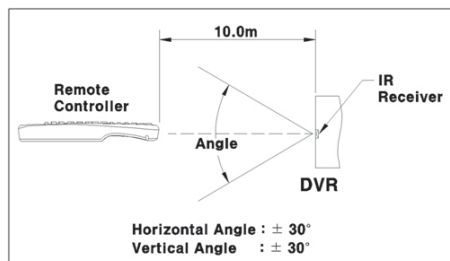
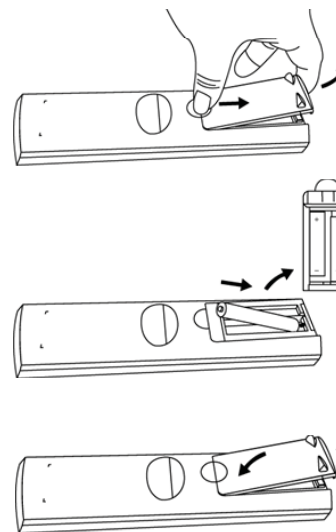

Figure 2.6.3 Remote Control Device's Usable Range

### Changing Batteries

The Remote Control takes AAA-sized batteries. Here is how to insert new or replacement batteries:



1. To remove the rear battery cover, press it forward.

2. Check the battery contacts inside the remote controller: + and -. Insert each battery matching the battery contacts and battery poles.

3. Reinsert the battery cover.

## Chapter 3. Hardware Installation

This chapter describes how to install the hardware. It includes instructions for installing the SVR-1670 in a rack or on a desktop; connecting devices to the SVR-1670 including cameras, monitors, sensors, relays; in addition to handling and preparing wiring.

The information is presented in these sections.

- 3. 1 Installing the SVR-1670 in a Rack
- 3. 2 Working with Input/Output Terminals
- 3. 3 Basic Connections to the SVR-1670
- 3. 4 Extended Connections to the SVR-1670
- 3. 5 Remote Monitoring and Control
- 3. 6 Hard Disk Drive Installation

# Chapter 3. Hardware Installation

## 3.1 Installing the SVR-1670 in a Rack

To use the SVR-1670 safely, please install the SVR in a rack using the enclosed rack mounts. Follow these instructions to install the SVR-1670 in a rack.

1. Attach the enclosed rack mounts to the product.

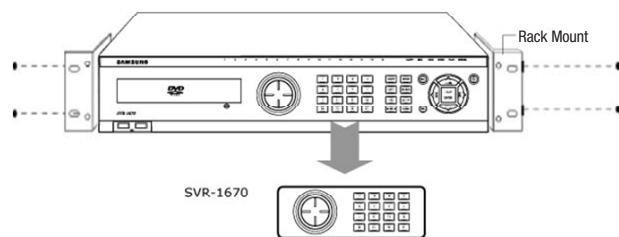

2. Attach the enclosed rack mounts to the product.

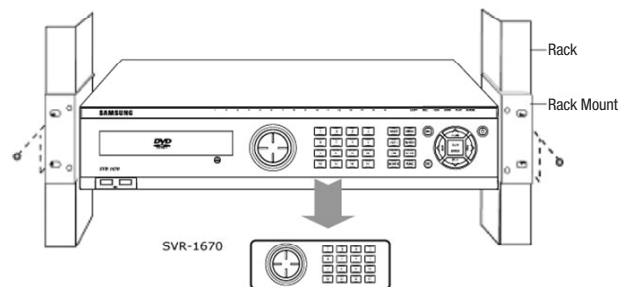

## 3.2 Working with Input/Output Terminals

This section discusses the proper handling of wires and cables when connecting sensors, relays and other devices to the SVR-1670.

### Handling Cable Ends

You might need to prepare cables before connecting them to terminal blocks. Different wire gauges are needed for stranded wire or solid wire. Prepare the end of the wire by removing the following amounts of insulation:

- **Stranded wire** : Strip 1/3 ~ 1/2 (8 ~ 10mm) of insulation off the end of the wire and solder it together. Use AWG 22 ~ 26 wire.

- **Solid wire** : Strip 1/3 ~ 1/2 (8 ~ 10mm) of insulation off the end of the wire. Use AWG 20 ~ 26.

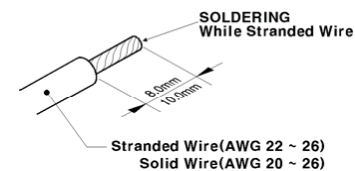

Figure 3.2.1 Preparing Cables for Terminal Blocks

### Wire Insertion and Removal

When inserting or removing a wire from a terminal block, do it while holding down the terminal block with a screw driver.

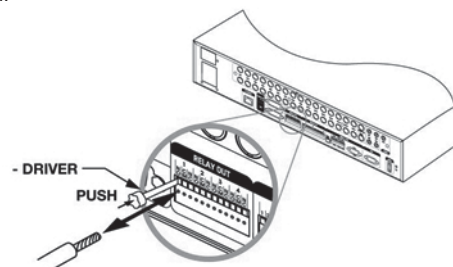

Figure 3.2.2 Inserting and Removing Wires

## 3.3 Basic Connections to the SVR-1670

This section explains how to connect devices to the SVR-1670, within the following subsections:

- Basic Connection Diagram
- Connecting Cameras
- Connecting a Monitor
- Connecting Audio
- Connecting the Power Cable



Always turn off the SVR-1670 and disconnect the power cord from its power source before you connect devices to the SVR-1670.

## Chapter 3. Hardware Installation

### Basic Connection Diagram

The following configuration diagram depicts a basic sample configuration that include cameras, monitors, sensors, and relays. These diagrams are representative only and are not intended to depict the only possible configurations for the SVR-1670.

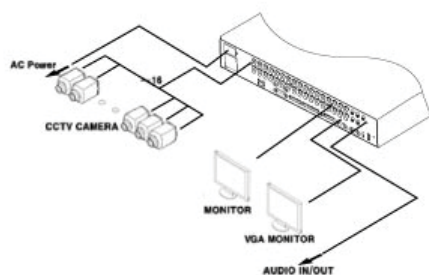

Figure 3.3.1 Sample Connection Diagrams

### Connecting Cameras

1. Ensure that the SVR-1670 is not connected to a live power source.
2. Using video cable, connect up to 16 standard CCTV cameras to the SVR-1670. Follow the instructions provided with the cameras to connect them to an external power source.

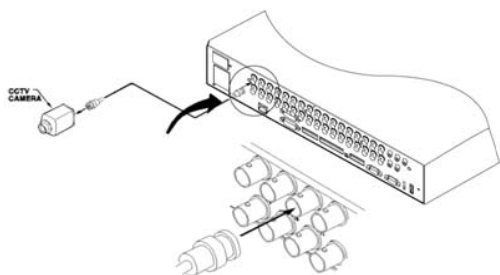

Figure 3.3.2 Connecting Cameras to the SVR-1670



Never connect both NTSC and PAL cameras to the SVR-1670 at the same time. The SVR-1670 recognizes only one camera type at a time. For automatic recognizing the NTSC/PAL system, connect and turn on the camera before turning on the SVR-1670.

The following default settings are assigned to cameras that are connected to the SVR-1670.

- **Video input type**, which is determined by the device that is connected to the lowest channel number. For example, if there are five cameras connected to the SVR-1670 and the lowest channel number in use is 6, then the SVR-1670 will set the video input type to match the camera connected to channel 6.
- **About Video In and Out Connections**

The SVR-1670 uses the "Auto Terminating Resistance" setting for the video input and loop output connections. If the BNC terminal is connected only for video inputs, the terminal resistance is automatically set to  $75\Omega$ . If the terminal is connected for both video inputs and loop outputs, the terminal resistance is set to Hi-Z; you must configure the terminal resistance of the output device to  $75\Omega$ . The loop output terminal is only for video inputs; use it only if there is video input to the BNC input terminal of a camera. Connecting an end of a cable to the loop output terminal without connecting the other end to an external device may cause degradation in video quality.

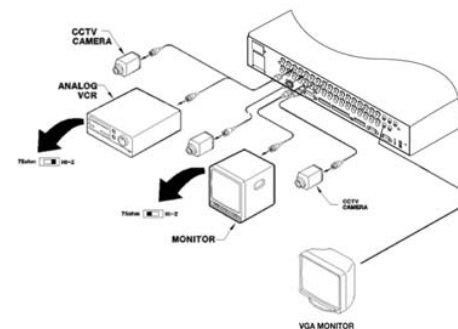

Figure 3.3.3 Video Input and Output Connections

## Chapter 3. Hardware Installation

### Connecting a Monitor

1. Ensure that the SVR-1670 is not connected to a live power source.
2. Using a monitor cable, connect a monitor or monitors to the SVR-1670.

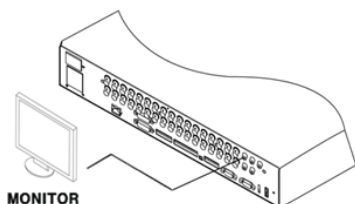

Figure 3.3.4 Connecting Monitors to the SVR-1670

3. Connect the monitor's power cord to the monitor and to an external power source.

### Connecting Audio

1. Ensure that the SVR-1670 is not connected to a live power source.
2. Using RCA audio cables or D-SUB cables, attach a microphone and speakers to the SVR-1670.

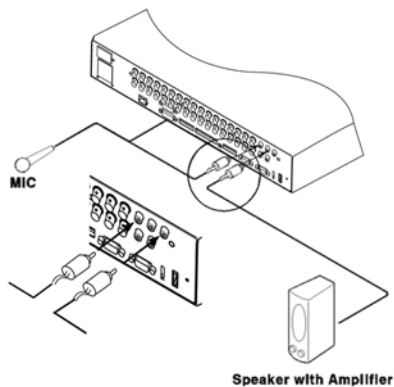

Figure 3.3.5 Connecting Audio to the SVR-1670

3. Refer to Figure 3.3.6 when connecting devices with D-SUB cables.

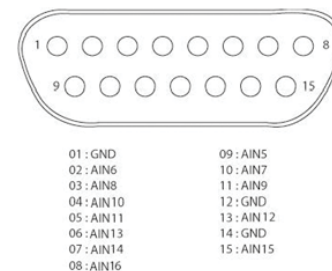

Figure 3.3.6 The Audio Pin Assignments

### Audio In/Out Connections

Two types of audio input are available: 4 RCA audio (1~4ch) and 12 D-SUB audio inputs (5~16ch). A total of 16 different audio inputs are acceptable, and 1 output can be used to check the quality of the audio input. Connect the D-SUB audio inputs as shown in Figure 3.3.7 Audio Input & Output Connection.

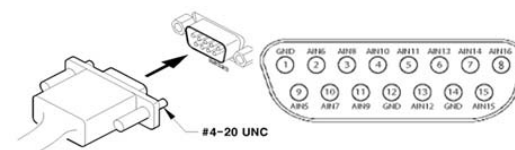

Figure 3.3.7 Audio Input and Output Connections

## Chapter 3. Hardware Installation

### Connecting the Power Cable

Connect the power cable as shown in the following figure. The SVR-1670 starts automatically when the power is connected.

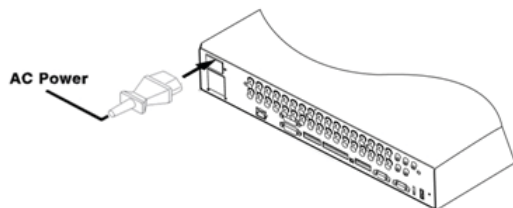

Figure 3.3.8 Connecting a Power Cord

- To turn off the SVR-1670, press and hold the power button for 5 seconds, then choose "Yes" when the power-off dialog appears.
- You can also unplug the power cable from the power outlet to turn off the SVR-1670.

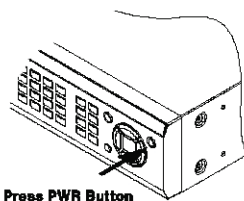

Figure 3.3.9 Turning On the SVR-1670

### 3. 4 Extended Connections to the SVR-1670

This section explains how to connect additional devices to the SVR-1670. It includes the following subsections :

- Extended Connection Diagram
- Sensor Connections and Settings
- Relay Connections
- D-I/O(Digital-I/O) Connections And Settings
- Serial communication terminal connections

#### Extended Connection Diagram

The following picture is an example of connecting the product with a series of external devices: sensor inputs, relay outputs, D-I/O, serial communication terminals, and storage. Please refer to this example for your information.

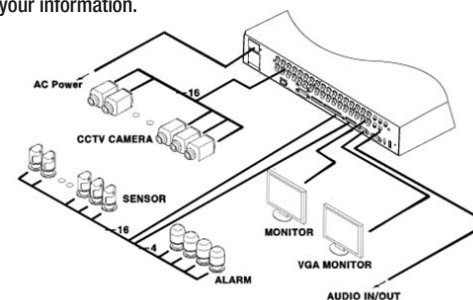

Figure 3.4.1 Extended Connection Diagram

#### Sensor Connections and Settings

Connect sensors to S1 through S16. Sensors can be connected with dry contacts.

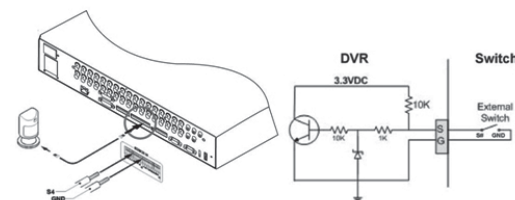

Figure 3.4.2 Sensor Connections

## Chapter 3. Hardware Installation

The sensor specifications are as follows.

Specification	No. of inputs	16 transistor input
	Input types	N.C, N.O support
	Support Sensor	Dry contact sensor
	Connection method	Insert stripped wire end into terminal block
Electric capacity	Pulse width of usable input	Minimum 500ms
	Output power	Typical DC 12mA

### Relay Connections

Connect relays to R1 through R4 as illustrated in the figure below. The illustration in Figure 3.4.3 shows how to connect a warning light.

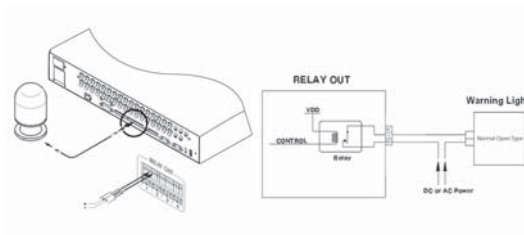

Figure 3.4.3 Relay Connections for a Warning Light

The alarm specifications are as follows.

Specification	No. of outputs	4 relay outputs
	Output type	Dry contact
	Connection method	Insert stripped wire end into terminal block
Rated current	DC	24V 1A
	AC	125V 0.5A

### D-I/O Connections And Settings

Connect a digital device to the D-I/O input and output terminals.

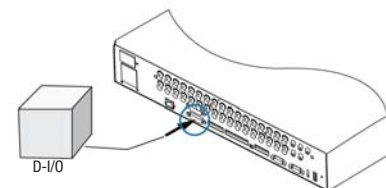

Figure 3.4.4 D-I/O device connection

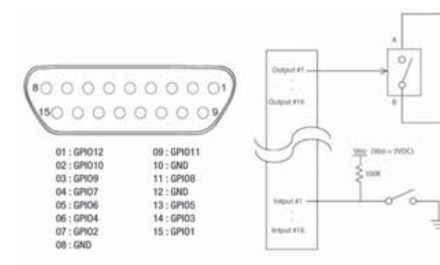

Figure 3.4.5 Digital Input/Output Connections

The D-I/O specifications are as follows.

Specification	No. of inputs/outputs	12
	Output type	DC 3V output
	Connection method	Connect stripped wire end with 15 pin D_SUB.
Rated voltage	DC	3.3 V

# Chapter 3. Hardware Installation

## Serial communication terminal connections

Several types of devices can be connected to the SVR-1670 through serial ports. Access control, ATM, and PoS transaction data can be transmitted through the COM1 port. PTZ cameras can be connected and operated through the COM2 or COM4 ports.

### Connecting Access Control, ATM, or PoS Devices

Use an RS-232 cable to receive text data from the PoS or ATM terminal via the COM1 port. COM1 and RS-232 (9-pin D-SUB) are used to receive text data.

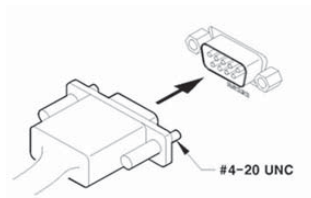

Figure 3.4.6 ATM, PoS, Access Control Connections

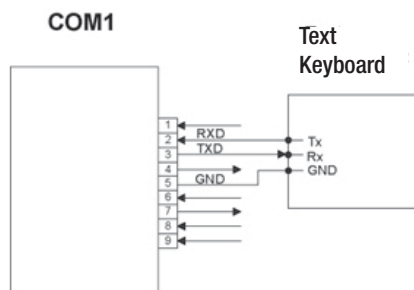

Figure 3.4.7 COM1 Connection (RS-232)

### Connecting PTZ Cameras to the COM Ports

Use RS-422 or RS-485 ports (COM2 or COM4).

- PTZ cameras for the SVR-1670 can be connected through the COM port, and supported models configured through the onscreen display menu.

The following figures illustrate how to connect PTZ cameras through the RS-422/485 port (COM2/COM4) and how to connect other devices through the serial port connection terminals.

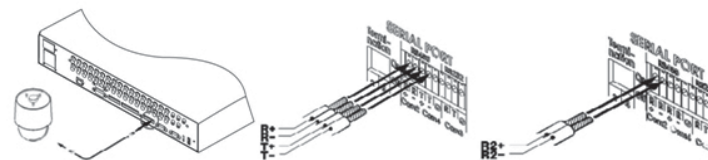

Figure 3.4.8 PTZ Camera Connection (COM2)

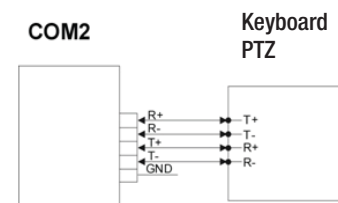

Figure 3.4.9 COM2 Connection (RS-422/485)

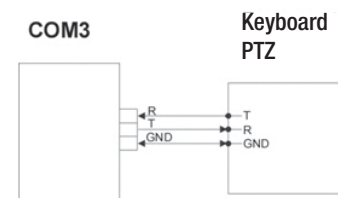

Figure 3.4.10 COM3 Connection (RS-232)

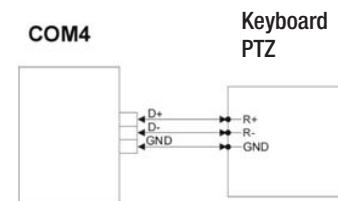

Figure 3.4.11 COM2 Connection (RS-485)

# Chapter 3. Hardware Installation

## External storage connections

You can connect an eSATA external hard disk drive and a USB memory device to the SVR-1670. To extend the storage capacity of the HDD, you may connect an eSATA external storage device to the eSATA port on the back of the SVR-1670. The eSATA port supports our SVS-5R eSATA external hard disk drive. (External USB hard disk is not supported.)

### Connecting an eSATA Device

Turn off the SVR-1670 before you connect an external device to it.

1. After you turn off the SVR-1670, use the eSATA port on the back panel of the SVR-1670 to connect an SVS-5R external hard disk drive.
2. Attach a power cord to the drive and connect it to an external power source. If necessary, turn on the eSATA drive.

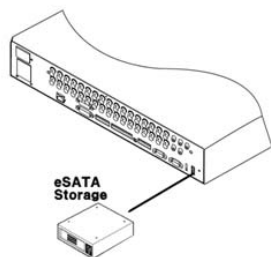

Figure 3.4.12 Connecting an eSATA Drive

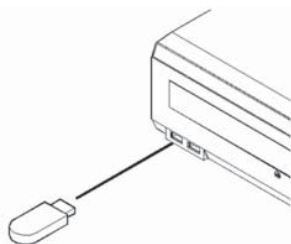

Figure 3.4.13 External Device Connections

3. Turn on the SVR-1670.

## 3. 5 Remote Monitoring and Control

This section describes how to configure remote access to the SVR-1670. It contains the following subsections.

- Internet/Intranet Connection Diagram
- Ethernet Connections

### Internet/Intranet Connection Diagram

The following example is a wiring diagram for the SVR-1670 to control it remotely over the internet or intranet.

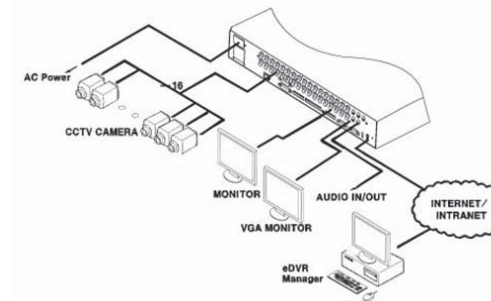

Figure 3.5.1 Internet Connection

### Ethernet Connections

Follow these steps to connect an Ethernet cable to the SVR-1670 :

1. Turn off the SVR-1670.
2. Connect one end of the Ethernet cable to the SVR-1670 and the other end to a hub or router.

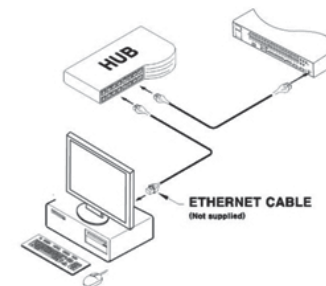

Figure 3.5.2 The Ethernet Connections



## Chapter 3. Hardware Installation

3. Turn on the hub or router.
4. Turn on the SVR-1670.



To prevent damage to the SVR-1670, wait to turn the power on until after you have connected the Ethernet cable.

### 3.6 Hard Disk Drive Installation

This section describes how to work with a hard disk drive, in the following subsections :

- Installing a Hard Disk Drive
- Enabling a Hard Disk Drive
- Removing a Hard Disk Drive
- Disabling a Hard Disk Drive



Always turn off the SVR-1670 and unplug the power cable before you attach or remove a hard disk drive. Disconnect any devices that are connected to an external power source.

#### Installing a Hard Disk Drive

1. Open the upper cover of the product, and then remove the four screws that connect the hard disk drive bracket and main unit.

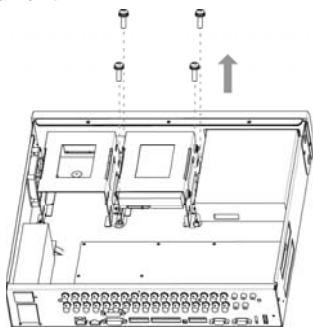

Figure 3.6.1 Removing Screws that Connect the SVR-1670 & Hard Disk Drive Bracket

2. Lift up the hard disk drive bracket, and then insert a hard disk. Fasten the disk to the bracket using the enclosed fixture screws, as shown in the picture below.

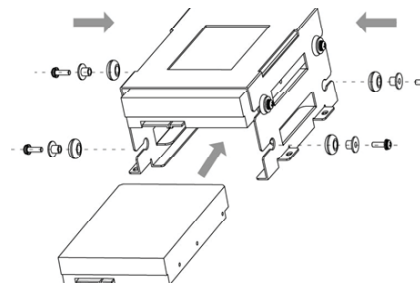

Figure 3.6.2 Inserting Hard Disk to the SVR-1670

3. Reattach the hard disk drive bracket to the SVR-1670 main unit.

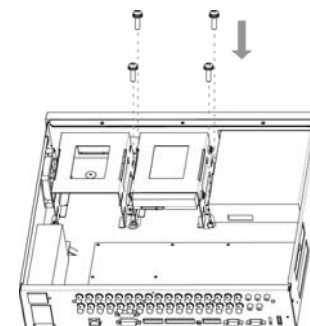

Figure 3.6.3 Reattaching Hard Disk Drive Bracket to the SVR-1670

4. Once the bracket is securely attached, connect the SATA cable.

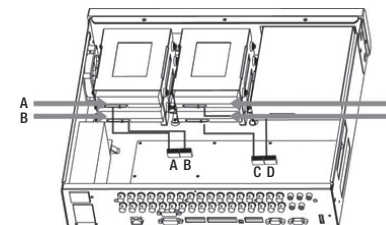

Figure 3.6.4 Connecting SATA cable

## Chapter 3. Hardware Installation

5. Connect the SMPS (switched mode power supply) power cable.

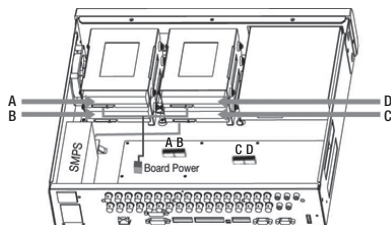

Figure 3.6.5 Connecting SMPS Power Cable (Change the Image)

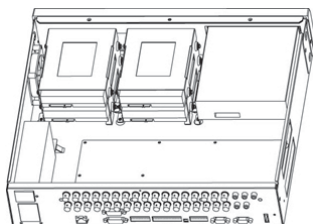

Figure 3.6.6 The SVR-1670 Connected with Maximum Number of HDDs

6. Close the upper cover on the SVR-1670, and then reconnect all devices that were removed for the hard drive installation.  
Now, it is time to configure and activate the hard disk drive.

### Enabling a Hard Disk Drive

To enable the newly attached hard disk drive, you must change its availability to "O" on the SVR-1670's Disk Manager menu.

1. From the OSD, select the System Settings menu.
2. Select the Disk submenu and then, select Disk Manager.
  - The newly installed hard disk drive appears in the list along with O and X under the State category.



Figure 3.6.7 Disk Manager Menu Showing Disabled Hard Disk Drive

3. To change to Enabled status, select the hard disk drive to connect and then press ESC to exit the Disk Selection menu. To enable the hard disk drive, select Add and then press Enter. You can add the hard disk drive to store data.



Figure 3.6.8 Disk Manager Menu Showing Enabled Hard Disk Drive

## Chapter 3. Hardware Installation

### Removing a Hard Disk Drive

To detach a hard disk drive, follow the instructions below:

1. Unplug the SATA and power cables. Remove the screws that connect the SVR-1670 main unit and the hard disk drive bracket.

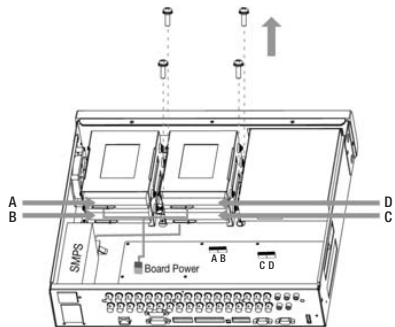

Figure 3.6.9 Removing Screws that Connect the SVR-1670 and Hard Disk Drive Bracket

2. Lift up the loose hard disk bracket.

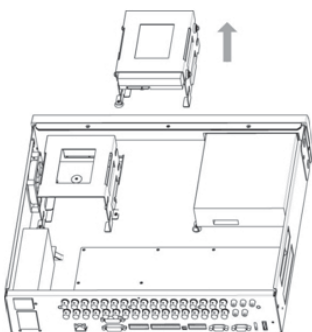

Figure 3.6.10 Lifting Hard Disk Drive Bracket from the SVR-1670

3. Remove fixture screws on the both sides of the hard disk and the bracket. Store the removed fixture screws safely, so you can use them to connect a hard disk again later.
4. Push the hard disk drive out from the bracket.

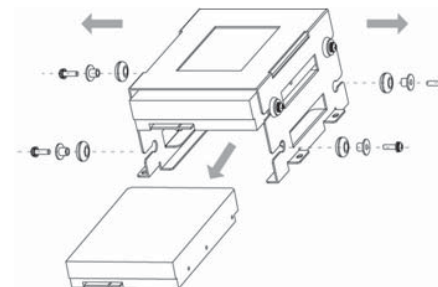

Figure 3.6.11 Removing Hard Disk Drive

Now, it is time to configure and disable the hard drive from the system.

### Disabling a Hard Disk Drive

To disable the removed hard disk drive, you must change its availability to "X" on the SVR-1670's Disk Manager menu.

1. From the OSD, select the System Settings menu.
2. Select the Disk submenu, and then, on it, select Disk Manager.
3. Select the removed hard disk drive, and then press ESC to exit the menu. Select Remove, and then press Enter.
4. At the confirmation message, select "Yes" to remove the hard disk drive from the list.



Figure 3.6.12 Disk Manager Menu Showing Disabled Hard Disk Drive

## Chapter 4. Navigation: On-Screen Display and Function Menus

This chapter provides information about using the two graphical user interfaces for the Samsung SVR-1670 DVR—the On-Screen Display and the Function menu.

The On-Screen Display (OSD) provides access to all SVR-1670 features and settings through a series of menus, submenus and options.

The Function Key menu provides access to all SVR-1670 functions, such as operation of cameras and manipulation of recorded video, through a main menu with icons.

You can access both the OSD and Function menu using the buttons on the SVR-1670 front panel, the mouse, or by using the remote control device.

The information is presented in these sections :

- ▶ 4. 1 Working with the On-Screen Display
- ▶ 4. 2 Working with the Function Menu



Note on followings when using with mouse:

- Do not operate any other process until the mouse cursor appears when you connect a mouse to the product.
- If the attached mouse is not operated for a long period, mouse may not work properly.

### 4. 1 Working with the On-Screen Display

You will use the OSD to set up, configure and operate the SVR-1670. The section discusses how to work with the OSD and covers the following topics :

- Accessing the OSD
- Understanding the Menu Structure
- Using the On-Screen Keyboard
- Setting the Date and Time
- Saving Your Changes on the OSD

#### Accessing the OSD

To access the OSD, you can either :

- Press the MENU button on the front panel. To close it, press the ESC button.
- Press the Menu button on the remote control. To close it, press the ESC button.
- Press the “Home” icon on the Function menu. To close it, press the ESC button.

#### OSD Screen Elements

The OSD contains a row of tabs at the top with icons representing seven menus—Quick Setup, Display, Record (HDD), Event, Communications, System Setup, and Exit.

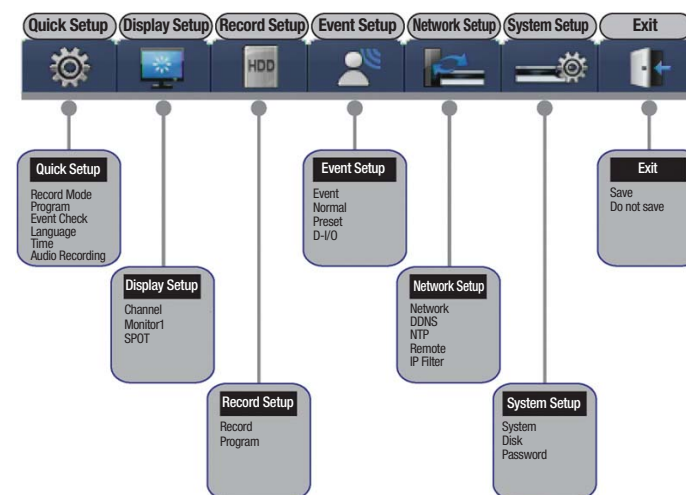

Figure 4.1.1 The On Screen Display

Each menu has a gray title bar with submenus, demonstrated in Figure 4.1.2 :



Figure 4.1.2 The OSD Menu Structure

Notice that on the submenu, options are listed on the left side of the screen, with settings to the right.

As you work on the OSD you will quickly learn how to use your preferred method of moving from menus, options and settings. This table gives you the basic instructions you need to know to get started.

## Chapter 4. Navigation: On-Screen Display and Function Menus

Place in OSD	Description / Navigation
Menu	<p>Current menu tab is highlighted in blue.</p> <p><b>Move between menus in any of these ways :</b></p> <ul style="list-style-type: none"> <li>- DVR front panel : Use the left and right buttons, then press PLAY/ENTER to make your selection.</li> <li>- Mouse : Press the mouse's left key to make your selection.</li> <li>- Remote Control : Use the left and right arrow buttons, and then press Enter to make your selection.</li> </ul> <p>To select a different menu or to exit the OSD, press Exit.</p>
Submenu	<p>Current submenu is displayed with a yellow underline.</p> <p><b>To go across submenus :</b></p> <ul style="list-style-type: none"> <li>- DVR front panel : Use the left and right buttons, then press PLAY/ENTER to make your selection.</li> <li>- Mouse : Press the mouse's left key to make your selection</li> <li>- Remote Control : Use the left and right arrow buttons, and then press Enter to make your selection.</li> </ul> <p>To go to a different menu, press ESC.</p>
Option	<p>Current option is highlighted in blue.</p> <p><b>To go between options :</b></p> <ul style="list-style-type: none"> <li>- SVR-1670 Front : Use the left, right, up, and down buttons to move the cursor, and then press Play/Enter to make a selection.</li> <li>- Mouse : Use the mouse wheel to scroll or press the left button on the mouse to make a selection.</li> <li>- Remote Control : Use the left and right arrow buttons, and then press Enter to make your selection.</li> </ul> <p>To go to a different submenu, press ESC.</p>
Setting	<p>Current or default setting is displayed in gray text field.</p> <p>A double forward caret &gt;&gt; means there is an additional submenu, with more settings for you to choose.</p> <p><b>To adjust a settings :</b></p> <ul style="list-style-type: none"> <li>- SVR-1670 Front : Use the left, right, up, and down buttons.</li> <li>- Mouse : Scroll with the mousewheel and Double-click to select a sub menu.</li> <li>- Remote Control : Use the left and right arrow buttons.</li> </ul> <p><b>To edit data :</b></p> <ul style="list-style-type: none"> <li>- For a numeric value, use the left/right or up/down arrow buttons.</li> <li>- For text, use the on-screen keyboard.</li> </ul> <p>Press ESC to move away from the setting.</p>

### Using the On-Screen Keyboard

Use the on-screen keyboard to input text.

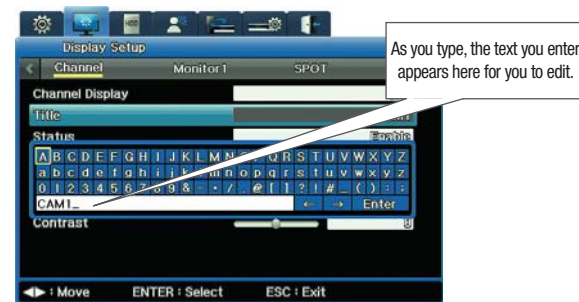

Figure 4.1.3 The On-Screen Keyboard

To enter text on the on-screen keyboard :

- Use the left/right or up/down arrow keys to choose characters.
- Use back arrow ← to backspace, and forward arrow → to insert a space.
- Press the ENTER key to exit the keyboard and save your text.

### Saving Your Changes on the OSD

Be sure to save your changes when you exit the OSD. Whenever you make changes to an option on the OSD, you must save them so they go into effect.



Figure 4.1.4 The Exit Menu

## Chapter 4. Navigation: On-Screen Display and Function Menus

To save your changes :

1. Select the Exit tab on the OSD.
2. Select "Save".
3. When the confirmation message appears, select "Save".
  - If you decide you do not want to save changes, select "Don't save".

### 4.2 Working with the Function Key Menu

From the Function Menu you can access the OSD, operate other DVR functions, and control camera playback. This section explains how to access the FUNC menu, and what each icon on the menu means.

#### Accessing the Function Menu

To access the Function menu, use any of these methods :

- Press the FUNC button on the DVR front panel. To close it, press the ESC button.
- Right-click the mouse. To close it, right-click again.
- Press the FUNC button on the remote control. To close it, press the ESC button.

#### Understanding the Menu Structure

Two types of function key menus are provided: Live Function and Playback Function. The Live Function menu controls various functions of the SVR-1670 while Playback Function controls video play options.



Figure 4.2.1 Live Mode Function Menu



Figure 4.2.2 Playback Mode Function Menu

The following table explains what function is controlled by each icon :

Icon	Function
	Opens the OSD. The FUNC menu closes and the OSD is available.
	Displays a list of system information.
	Select the Monitor you wish to view. This icon is set to toggle, which means each time you select the icon, your view shifts to the next monitor for however many monitors you have set up.
	Displays the images to which you have channels. This icon is set to toggle, which means each time you select the icon, your view shifts through the various display layouts available (1x, 4x, 9x, 16x).
	Begins camera Sequencing, if you have setup your channels to display live camera feeds in sequence.
	Goes to Zoom menu.
	Begins Pan/Tilt/Zoom functions if you have a PTZ camera linked to the DVR.
	Opens the Search submenu.
	Opens the Copy submenu.
	Rewinds recorded video at half speed.
	Rewinds recorded video.
	Stops playback of recorded video.
	Plays recorded video.
	Pauses recorded video.
	Forwards recorded video.
	Forwards recorded video at half speed.

# Chapter 5. Quick Setup

This chapter explains the Quick Setup menu, from which you can set the recording mode and the system date and time. You can also turn on event checking and audio, and select the language for the system to use.

This chapter information is presented in the following sections:

- ▶ 5.1 Working on the Quick Setup Menu
- ▶ 5.2 Setting the Record Mode
- ▶ 5.3 Setting the Date and Time

## 5.1. Working on the Quick Setup Menu

You access the Quick Setup menu by clicking the Quick Setup tab on the OSD. This section explains its options and settings.

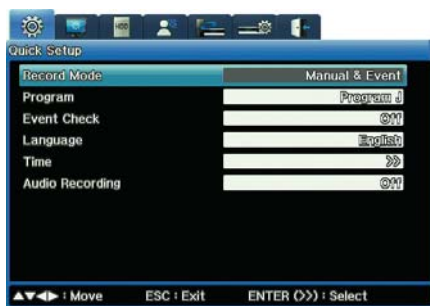

Figure 5.1.1 Quick Setup Menu

Option	Settings
Record Mode	Specify how you want to record: by Schedule & Event, or Manual & Event.
Program	Enables to select a recording program when the Manual & Event mode is set to Recording. Disables the Program option when the Schedule & Event mode is set to Recording.
Event Check	When you want the system to check for events: Always, according to the Schedule you selected, or Off (no checking performed).
Language	The language you want to display on menus and screens.
Time	Set the date and time by which the system is to run, record and timestamp data.
Record Audio	Set to On or Off.

## 5.2. Setting the Record Mode

This section provides a brief discussion about the record mode settings of Schedule & Event and Manual & Event

### Manual & Event

You can configure the product to start recording when the REC button on the front panel is pressed, or when a preset event occurs.

If you set Manual & Event for the Record Mode, you must also select a Program from the Program option. Settings run from Program A through Program Z.

To review or edit the definition of a program, move to the Record Setup menu in OSD, and then select a submenu program.

After you've selected Manual & Event and its program, press the REC button on the DVR's front panel to begin the recording. The Rec light will glow red during recording.

While recording, an initial M displays on the upper right side of the screen, indicating the Manual recording mode.

### Schedule & Event

You can configure the product to start recording on a scheduled date or when a preset event occurs. If you select Schedule & Event, you need to setup the schedule.

1. From the Schedule option, access the Schedule submenu. This menu is in a calendar format showing each day of the week and 24 hours with each day.
2. On this Schedule, select which Program to run on any given day, or hours of that day.  
Here is an example showing Program A entered as the program to run on Mondays and on Tuesdays from Midnight until Noon.

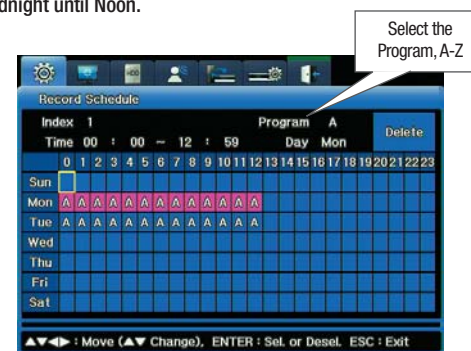

Figure 5.2.1 Schedule Submenu from Quick Setup

## Chapter 5. Quick Setup

- Once you have completed the Record setup, notice the Rec light on the DVR's front panel flickers and the symbol S displays to show that all channels are recording as scheduled.

### 5. 3. Setting the Date and Time

Setting the system time is very important for the validity of your recorded data. The date and time you set governs all schedules you subsequently configure on the DVR. The date and time appear on all monitor displays and on all timestamps for events.



Plan carefully if you need to set the date and time!  
Back up video before changing the time.  
Do not change time setting while recording. Doing so can compromise the date stamping of the recording.

To set the date and time, follow these steps :

- Select the Time option from the Quick Set menu.
- Enter the time zone for the camera location. (The default setting is UTC 00:00 Dublin.)



Figure 5.3.1 System Time Submenu on Quick Setup

- Set Daylight Savings to on or off. (The Daylight Savings option is only available if daylight saving time is used in the time zone you selected.)
- Select the Date Format you prefer.
  - Formats are YYYY/MM/DD or MM/DD/YYYY or DD/MM/YYYY.
- Set the Time by entering data in each of the Date fields and in the Hour/Minutes/ Seconds fields.
- When a confirmation message displays, select "Apply" to change the new Date/Time settings.
  - When the confirmation message appears, select Yes if you want to confirm your changes to the date/time setting.



If only GMT/DST was changed, timestamp of recorded video remains as before the change (recorded time). Note that the timestamp of recorded video will be changed accordingly if the current time is changed.

## Chapter 6. Using the System Setup Menu

This chapter provides information about the features on the OSD's System Setup menu, from which you setup various system-wide controls for the DVR

The information is presented in these sections :

- ▶ 6.1 Using the System Setup Options
- ▶ 6.2 Using the Disk Options on the System Setup Menu.
- ▶ 6.3 Working with Passwords and Permissions.

### 6. 1 Using the System Setup Options

You access the System Setup menu by clicking its tab on the OSD. This section explains its four submenus, their options and settings.



Figure 6.1.1 System submenu on the System Setup Menu

Option	Settings
Language	Select a language.
Key Buzzer	Select On if you want a buzzer to sound when you use the buttons on the front panel.
Default	Select this menu to reset the DVR to the factory default mode. At the warning message, select "Yes" again to restore the settings.
Load/Save Configuration	Select Save if you want to save settings to USB storage. Select Load if you want to load stored settings from USB storage.
Firmware Update	To update the firmware version of the SVR-1670, connect a USB storage device to the DVR, and then select this menu.
DVR Alias	Set a SVR-1670 alias; that is, give the SVR-1670 its own name such as "Main Floor," "Headquarters," or "Fred."
System Log	Displays a log, by time, of various events within the system
Time	Set the system time. You can set the time in two places: here and on the Quick Start menu.



## Chapter 6. Using the System Setup Menu

### Updating Firmware

You can update the firmware you are using for video access and management.

1. Insert a USB drive containing firmware update files to one of the USB ports on the SVR-1670.
2. Select Firmware Update from the System submenu.
3. When the confirmation message appears, select “Yes”.
4. Upon the completion of an update, the SVR-1670 automatically reboots.

You can also update firmware through the Network.

(Firmware upgrading via network is not available during playback of recorded video.)

### Working with the System Log

You can display the system log to review actions that have occurred or to copy the log.

### Reviewing the System Log

1. Select System Log from the System submenu on the System tab.  
The System Log appears, showing actions that have occurred on the system, such as when menu settings were changed and when system events occurred.



Figure 6.1.2 System Log submenu of the System Menu

2. Select any line labeled “Config Changed” to open a submenu that explains what menu setting was changed and who changed it.



Figure 6.1.3 Config Changed Info submenu from the System Log

### Copying the System Log

You can save a system log to a USB flash drive.

1. Insert a drive into a USB port.
2. Open the System Log list.
3. Press the COPY button on the front panel.

The system logs is saved as a text file, with the file name <Model Name>\_System Log\_<Date&Time.txt >—for example, SVR1670\_SystemLog\_20090101\_153025.txt

# Chapter 6. Using the System Setup Menu

## 6.2 Using the Disk Options on the System Setup Menu

The Disk submenu under the System Setup menu tab provides the Disk Manager option to manage internal and external HDDs.

### Working with the Disk Manager Submenu

With the Disk Manager, you manage internal and external HDDs to track their status, bad blocks, size, whether enabled or disabled.

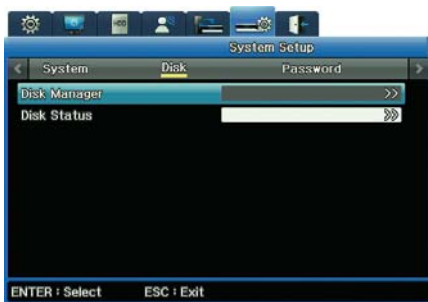

Figure 6.2.1 Disk Submenu of the System Setup Menu

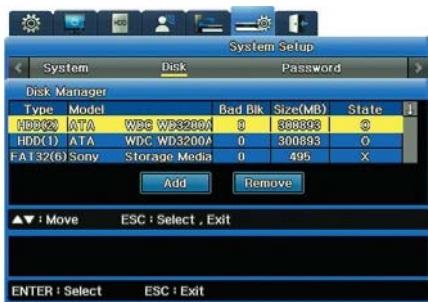

Figure 6.2.2 Disk Manager submenu on the System Setup Menu

Column Heading	Data
Type	Disk locations and types: · HDD(1)(Int 1 HDD) · HDD(2)(Int 2 HDD) · HDD(3)(Ext 1 HDD)
Model	HDD model numbers
Bad Block	Displays HDDs with bad blocks. "0" means no HDDs have problems. Blank means the HDD is disabled.
Size (MB)	Displays HDD sizes in MB.
Enabled	"0" means the HDD is enabled. "X" means the HDD is disabled.

### To Enable an Inactive HDD

1. In Disk Manager's State column, select "X".
2. Select "Add".
3. The following message appears: "This disk must be formatted before use. Would you like to format it?"  
-Select "Yes" to delete all the data in the HDD.  
-Select "No" to keep all the data in the HDD.
4. The HDD's status changes to "0" in the State column.

### To Disable an Active HDD

1. Under Disk Manager's State column, select "0".
2. Select "Remove".
3. The following message appears: "Would you like to remove the disk?"  
- Selecting "Yes" changes the HDD status to "X" in the State column.  
- Selecting "No" cancels the removal and retains the HDD status as "0".

## Chapter 6. Using the System Setup Menu

### Using Disk Status Submenus

The Disk Status submenus are available to check the temperature of the internal and external HDD as well as the S.M.A.R.T information.



Figure 6.2.3 Disk Status submenu on the System Setup Menu

## 6.3 Working with Passwords and Permissions

You set up permissions on the System Setup Menu's Password submenu.

Permissions are granted, or withheld, for using the various features and performing various tasks.

- The administrator has all permissions to use all functions of the SVR-1670.
- General users must be granted permissions to use features. You can set permissions for a maximum of 10 users. Each user can have completely different permissions than any other user—or all can have identical permissions.

### Setting and Reviewing Permissions

On the Password submenu, there are several columns (The password setup screen will not be displayed for normal users.):

The far left column shows various features for which permissions must be granted (such as permission to use PTZ, permission to turn off power, permission to copy video).



Figure 6.3.1 Password submenu on the System Setup Menu

The next column is Check.

- An "X" on any row in this column means all users have permission to use that feature.
- An "0" on any row in this column means each user must log in to use that feature. (Entering wrong password for 3 times will sound buzzer and this event is logged.)

The column next to Check is Admin.

- The Administrator always has permission to perform all tasks. This column contains 0s, and cannot be modified.

The columns next to Admin are for Users.

- An "0" on any row in this column means all users have permission to use that feature.
- An "X" on any row in this column means each user must have specific permission to use that feature. (If non-authorized user accesses the function, the buzzer alarms.)
- In the figure : 6.3.1 Password submenu on the System Setup Menu, User 1 has permissions for Menu, Playback, and Power Off. User 2 has permissions for PTZ, Relay Off, Playback, Power Off, Power On, and Copy.

### Knowing Your Password

When you first configure your SVR-1670, the default passwords are :

- For Admin, 11111111.
- For users, the 8-digit passwords follow this pattern : User 1 is 11111111; User 2 is 22222222, and so on. For User 10 the password is eight 0s in a row.

You can change passwords if you have permission to do so.

## Chapter 6. Using the System Setup Menu

### Changing Passwords

If you have the correct permission, you can change user passwords.

1. In the Change P/W row, select the user whose password you want to change.



Figure 6.3.2 Changing a Password

2. A New Password submenu opens, in which you enter the new password.

- Enter the new password using either the number buttons on the SVR-1670's front panel or the on-screen keyboard.
- A password must be 8 characters long alphanumeric words.



Figure 6.3.3 New Password submenu

3. Click the Change button.

## Chapter 7. Communication To/From the DVR

The Communication menu options allow you to configure for communication to and through a network, a DDNS server, NTP synchronization, and remote control devices.

These topics are explained in the following sections :

- ▶ 7.1 Setting up Network Communication
- ▶ 7.2 Registering with a DDNS .
- ▶ 7.3 Setting up for NTP Synchronization
- ▶ 7.4 Configuring Remote Control
- ▶ 7.5 Setting up IP Filter

### 7.1. Setting up Network Communication

Before you enter settings on the Network submenu, you need to know the type of network connected to the DVR. The type is either :

- **Ethernet**, if the DVR is connected to dedicated line, cable modem or LAN.
- **xDSL**, if the DVR is connected to a PPPoE-type xDSL line.

#### Setting Up for Ethernet

This section discusses the options available if your Network Type is Ethernet.

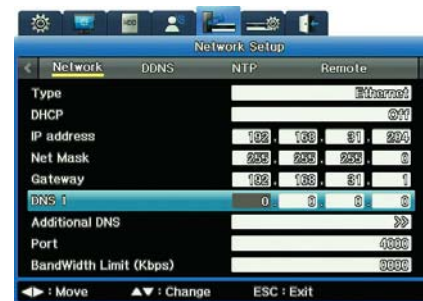

Figure 7.1.1 Network Submenu for the Type Ethernet (on the Network Setup Menu)

Option	Setting
Type	Ethernet is the correct type if the DVR is connected to dedicated line, cable modem or LAN.

## Chapter 7. Communication To/From the DVR

DHCP	Dynamic Host Configuration Protocol (DHCP) manages host addresses on a network. DHCP is used on a LAN with a DHCP server installed. If the LAN has a DHCP server and you have enabled this DHCP option, the DHCP server will allocate an IP address to the DVR.
IP address	IP Address is used for communication between the DVR and SVM-S1, and is also used when Web Viewer accesses the DVR. It is available only when Net Mask and Gateway are set.
Net Mask	Net Mask specifies a range of IP addresses and enables IP addresses in the range to communicate. Net Mask should be allocated by a network administrator.
Gateway	Gateway must be specified to enable IP addresses to communicate and should be allocated by a network administrator.
DNS1	DNS1 must be specified to register the DVR to DDNS Server(www.samsungipolis.com) while DNS Address should be allocated by a network administrator.
Additional DNS	Additional DNS is used to replace DNS1 when it is unstable or has a problem.
Port	Port used for connecting to SVM-S1 or Web Viewer. The default port number is 4000.
Bandwidth Limit (Kbps)	Kbps sets the maximum transmission speed of data output from the DVR (the data transmission capability of the DVR). This can be left blank. Ask your network administrator to specify it when necessary.

Option	Setting
Type	xDSL is the correct setting if the DVR is connected to a PPPoE-type xDSL line. (If the xDSL line is not of the PPPoE type, you must select Ethernet.)
ID	Enter your User ID.
Password	Enter your password.
Port	Port is used to register to connect to SVM-S1 or to Web Viewer. The default port is 4000.
Bandwidth Limit (Kbps)	This sets the maximum transmission speed of data output from the DVR (the data transmission capability of the DVR). This can be left blank. Ask your network administrator to specify it when necessary.
Status	Displays the connection status of the DVR.

### Setting up for xDSL

This section discusses the options available if your Network Type is xDSL.



Figure 7.1.2 Network Submenu for the Type xDSL (on the Network Setup Menu)

# Chapter 7. Communication To/From the DVR

## 7.2. Registering with a DDNS Server

To make the DVR's IP address easily identifiable, you can register, with a DDNS server, a dynamic IP address for the DVR. (Otherwise, the DVR has as a different IP address assigned every time it connects to the ISP, making it difficult to determine the DVR's IP address.)

This section explains how you complete DDNS setup, by:

- Registering a DVR with a Dynamic IP Address
- Configuring the DVR for DDNS

### Registering a DVR with a Dynamic IP Address

1. Go to the iPOLiS homepage, [www.samsungipolis.com](http://www.samsungipolis.com), and log in.
  - If you do not have an account, go to the My iPOLiS page, click Sign Up and follow the prompts to set up an account.

※ NOTE: The iPOLiS website is optimized for use only with the MS Internet Explorer browser.



Figure 7.2.1 iPOLiS Home Page



Figure 7.2.2 Product List on My iPOLiS Page

2. Click the Product Registration link to open the screen on which you can register your DVR.

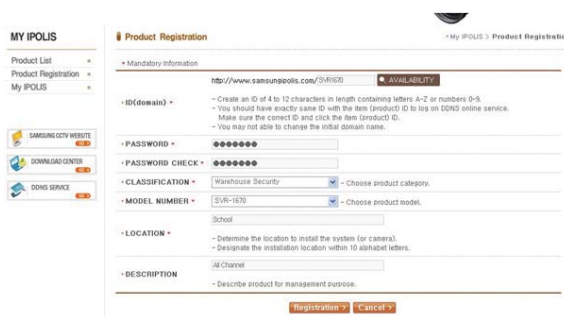

Figure 7.2.3 iPOLiS Product Registration Page

3. On the Product Registration page enter:
  - ID for your product. This will become its domain name. Once you register this ID, it cannot be changed.
  - Your iPOLiS password.
  - Choose a Classification for your use of the DVR.
  - Choose the model number of the DVR.
  - Enter a location. This can be any sort of word, phrase or code that makes sense to your business and situation.
  - Enter a description. This, too, can be any sort of word, phrase or code that makes sense to your business and situation.
  - Click the Registration button.

## Chapter 7. Communication To/From the DVR

4. The newly registered DVR now appears on your Product List page :



Figure 7.2.4 iPOLiS Product List Page

To manage the registered DVR

From the Product List you can, by clicking the appropriate button, View, Check or Edit the registration information about any particular product.

- You can edit data about the product, but you cannot edit its ID. If you want to change its ID, delete it and register it again, using a new ID.
- Click Delete if you want to remove the DVR from your list, either permanently or to re-register it with a different ID.

Now that you have registered the DVR, you need to configure it for DDNS.

### Configuring the DVR for DDNS

Complete the dynamic IP address settings for the SVR-1670 following the instructions, and then configure the DDNS settings.



Figure 7.2.5 DDNS Submenu on the Network Setup Menu

Option	Setting
Interval	The dynamic IP address renews the relevant data from the DDNS per each interval, thus maintaining a continuous registration status. If you set the registration interval to Off or if the DVR does not upload any information over two days, information for the DVR will be removed from the DDNS server.
Server	Enter your DDNS server address. The default is www.samsungipolis.com.
ID	Your iPOLiS sign in ID.
Password	Your iPOLiS password.
Status	DVR's registration status. · Not Registered means that the DVR is not registered to the DDNS. · Date/Time & OK means that the DVR has been registered to the DDNS.

### Verifying the Connection Status

Log into iPOLiS and review the Product list, to verify that the Product List shows the DVR's status as 'On'.

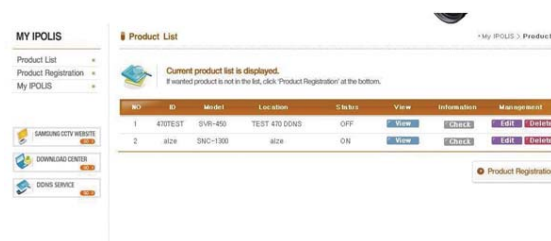

Figure 7.2.6 iPOLiS Product List Showing "On" Status

## Chapter 7. Communication To/From the DVR

### 7. 3. Setting up for NTP Synchronization

Network Time Protocol (NTP) synchronizes time between devices on network. On a network, a server provides the base time. The client systems receive the time from that server for synchronization.



Figure 7.3.1 NTP submenu on the Network Setup Menu

Set the options to your preferred settings to configure NTP :

Option	Setting
Sync With NTP	Turns NTP on or off.
NYP Mode	The NTP mode indicates the client.
NTP Server Location	Determines whether the NTP server is on a local network or on the Internet. This option is only available if NTP Mode is set to Client.
NTP Local Server IP	Sets the IP of the NTP server. Enter either the IP of an NTP server on the local network or the IP of a DVR with its NTP mode set to Server. This option is only available if the NTP Server Location is set to Local.
Interval	Set the synchronization interval; how often you want your system to communicate with the server to synchronize the devices.

### 7. 4. Configuring Remote Control

The SVR-1670 can be controlled remotely by various devices.



Figure 7.4.1 Remote Control submenu on the Network Setup Menu

Option	Setting
Remote Keyboard ID	Designation the keyboard operating all DVR functions with the controller buttons. The default value is 1. NOTE: If one keyboard is connected to several DVRs, it might conflict with other channels, so a different value should be set for the keyboard address.
Remote Controller ID	You can control up to 16 DVRs from one remote control by creating unique IDs for each DVR.
Remote Configuration Setup	Enable or Disable configuration to system management software.
Remote Relay	Use the system management software to enable or disable the relay controls.
Serial Port	Four serial ports are available for the DVR; two RS-232C ports and two RS-485 ports.
PTZ	Setting up PTZ options.



## Chapter 7. Communication To/From the DVR

### Setting Serial Ports

To set the serial port, first select the COM (communication port) :

- COM1 and COM3 are fixed to RS-232C
- COM2 uses RS-422/RS485
- COM4 uses RS-485.

1. Access the Serial submenu (to the right of the COM selection).
2. For the Device option, select a connected device.
3. Set the other selections— Baud rate, the Parity, Stop Bit and Data Bit—as appropriate for the device you've chosen.

### Setting PTZ Options

To set PTZ options for your cameras, first specify the camera's channel, 1 through 16.

1. Select a PTZ channel and access the popup for PTZ submenu.
2. Select a port that is connected to the camera channel and set PTZ Port.
3. Select an appropriate protocol for the PTZ camera control.
4. Select the Camera ID of the connected PTZ camera.
5. Set the PTZ Idle Time. This idle time is the duration of time before which the camera returns to home position. For example, if you set this to 5 seconds, PTZ returns to Home position when PTZ is not controlled for more than 5 seconds.

### 7. 5 Setting up IP Filters

You can selectively block or allow IPs to access the SVR-1670.

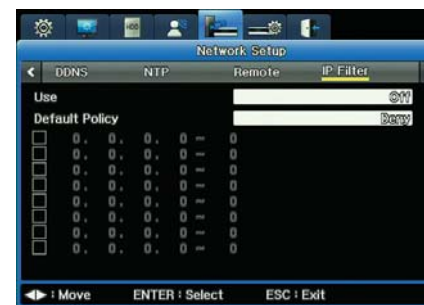

Figure 7.5.1IP Filter submenu on the Network Setup Menu

Option	Setting
Use	Select to use the IP filter.
Default Policy	Select to block or allow IPs using the default policy.
IP Range	Select a range of IPs to block or allow; Check the checkbox, and then enter the IPs.

## Chapter 8. Working with Events

This chapter provides information about actions you can take on the Event Setup menu of the OSD.

The information is presented in these sections:

- ▶ 8. 1 About Events
- ▶ 8. 2 Setting Up for Event Recording
- ▶ 8. 3 Working with Normal Events
- ▶ 8. 4 Working with Presets
- ▶ 8. 5 Working with Digital I/O

### 8. 1 About Events

With Event setup, you prepare the DVR to record when an event occurs. Event recording is launched based on input sensor, by motion detection, by text and by digital input. An event can be various things :

- Loss of video feed
- Motion detected in a monitored area
- The disk being full and no longer able to record

Event Recording can be set up in conjunction with other recording modes: i.e. Manual & Event or Schedule & Event.

### 8. 2 Setting Up for Event Recording

You set up for event recording from the Event submenu of the Event Setup menu on the OSD.

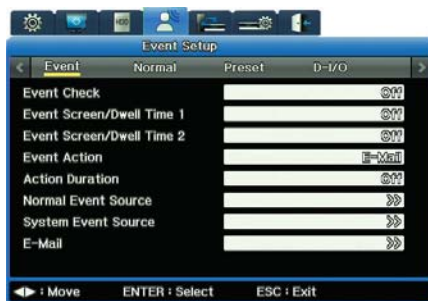

Figure 8.2.1 Event Submenu on the Event Setup Menu

For each option, enter the appropriate setting :

Option	Setting
Event Check	Three options are available to check events. To detect events at all times, select "Always." To disable event detection, select "Off." To detect events only for a preset duration, select "Schedule".
Event Screen/ Dwell Time	Select the Monitor for which you are setting the dwell time.
Event Action	Select what action should notify you about the Event: Relay 1~4, buzzer, or E-Mail.
Action duration	How long the Event Action should last, for the relay or buzzer. (E-mails are sent in specified time intervals.)
Normal Event Source	What action will trigger the event. Check the appropriate box for Sensor, Motion detection area, Camera channels (for video loss) or Text.
System Event Source	Press PLAY/ENTER to select and define an instance as the system event: Disk Error, Disk Full, Rec Fail, Authentication Failed, or DDNS Registration Failed.
E-Mail	This option become available if you selected Email as the Event Action.

### Working on the Schedule Submenu

You can schedule events for specific hours. You can set whatever works for your surveillance situation by day of week and hours of day.



Figure 8.2.2 Schedule submenu on Event setup

## Chapter 8. Working with Events

### Working with the Normal Event Source Submenu

The normal event source is the action that triggers the event. You access this submenu from the Event submenu on the OSD's Event Setup.

**S** stands for sensor.

**M** stands for Motion Detection.

**V** stands for Video.

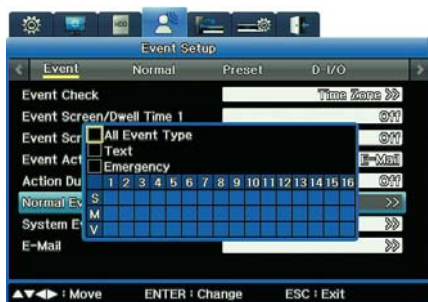

Figure 8.2.3 Normal Event Source submenu on the Event Submenu

Check the appropriate boxes for Sensor, Motion detection area, Camera channels (for video loss) or Text. You can check as many boxes as you need.

### Setting Up E-Mail for Event Action

If you selected Email as the Event Action option, you set it up on the Email Setup submenu.

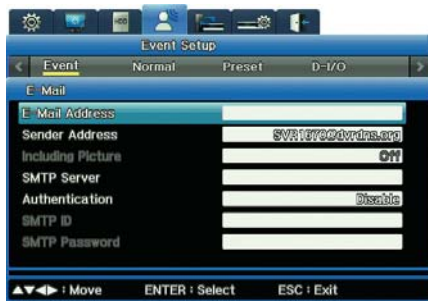

Figure 8.2.4 Email Setup submenu

Option	Setting
Email Address	Enter the e-mail address of the person receiving the notification. Use only Roman alphabet letters and numbers, in the format is xxx@xxxxx.xxx.
Sender Address	Enter an email address that identifies the DVR as the sender of the notification. This field is optional: if you use it, the format is xxx@xxxxx.xxx.
Including Pictures	For a Normal event, the system sends an e-mail with an image of the event channel as well as event information including the sensor, movement detection, and object disappearance. For a System event, the system sends only event information.
SMTP Server	Enter an SMTP server to send email.
Authentication	Select a server, and then set to Use.
SMTP ID	If Authentication is set to Use, enter your ID for the SMTP server.
SMTP Password	If Authentication is set to Use, enter the password for the ID entered above.

## 8. 3 Working with Normal Events



Figure 8.3.1 Normal Event submenu on the Event Setup Menu

Option	Setting
MD (Motion Detection)	Enables each channel or all channels to detect motion and notify users. Select one specific channel or set to All.
Sensitivity	Set to Lowest, 1~3, Highest or Off.

## Chapter 8. Working with Events

Area	If the MD Channel is set to All, the motion detection areas can be set to Set All or Clear All. If an individual channel is set for MD, Area can be set to Set All, Clear All or Select Area.
Sensor	You can set one sensor for the channel selected, or you can select all sensors (of 16 possible sensors available). Select the sensor, and set it to either N.O. (Not Open) or N.C. (Not Closed), or the setting can be Off.
Text	For text settings.

### Setting the Area for Motion Detection

You can set a particular area for motion detection surveillance.

For example, if your camera points to the car dealership's car lot, you will prefer motion detection around the cars themselves. You will be less interested in motion detection on the trees or light poles that surround your lot. In this case, you can limit the Motion Detection (MD) zone around the cars. To set your motion detection area:

1. From the Normal Event submenu, in the Area option, set Select Area.
2. For the Custom Area option, access the Custom Area grid, which shows 330 squares in a 22x15 representing the area your camera "sees."
3. Click a square to set it within your motion detection area. You can build up as large a detection area as you wish, positioned in whatever area of the grid is appropriate.
  - Each square turns gray when clicked and part of the detection area.
  - Click any square to deselect it.

### Setting for Text Events

Option	Setting
Recording	You can turn recording for text input on or off.
Device	Select either one of VSI PRO, VSI Hydra and Manual.
Sync Text With	This selects channels to link with text data.
Seek Header	By defining a header here, the DVR can recognize from the header that it is the start point of the data. Two headers can be set and detected because one device can send various types of data to external receivers. However, this parameter is needed to see how one unit of data out of continuously incoming text data is structured. All data has its start and end points, and the header is data that is always inserted to indicate the start point.
Header 1 and Header 2	Use the onscreen keyboard to enter the text you want displayed for the headers.
Delimiter	The delimiter value will differ depending on the device used. For more information on delimiters, refer to the user manual or the device manufacturer.
Timeout (ms)	DelimiterLines defined below are the maximum number of text lines available for one piece of data. Even though data is standardized, lengths might differ. For example, three lines are programmed for client name input for an ATM, but if someone registers only his/her first name and last name, only two lines are provided when the person uses an ATM. However, the DVR cannot detect this automatically, so Timeout is used to determine how long is needed to recognize the received data as complete data after the last line is entered.
Lines	Define the maximum number of lines for one piece of data.



External devices might not be recognized depending upon their particular features. Review their product documentation or contact their manufacturer for information.

## Chapter 8. Working with Events

### 8.4 Working with Presets

On the Preset submenu, you can setup for event detection based on preset camera angles you specify in the PTZ menu.

First, you need to define the preset for the PTZ camera attached to the channel.

1. On the Preset submenu of the Event Setup menu,
  - Set a channel number.
  - Choose the type of event—sensor, text, or MD (motion detection).
  - Enter the Preset number.

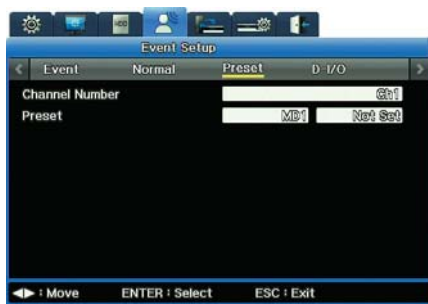

Figure 8.4.1 Preset submenu on the Event Setup Menu



Figure 8.5.1 The Digital I/O submenu of the Event Setup Menu

### Emergency Recording

Emergency Recording operates when you :

- When a digital I/O channel is set to “Input” and its Input Type is set to “Emergency”, video recording starts and continues based on the Recording After Event settings.

### 8.5 Working with Digital I/O

Digital I/O are digital ports available for input and output at the same time. The SVR-1670 has 12 digital inputs and outputs, all of which can be set to either input or output :

- When set to Input, an Emergency event is generated on the main unit if the corresponding port becomes Low by external cause.
- When set to Output, the port transfers output signal if selected event is generated on the main unit. — Available events for such Output setting are Text, Video Loss, Sensor, Motion Detection, and Emergency.

## Chapter 8. Scheduling and Recording Video

This chapter provides information about :

- **Scheduled Recording**, which records video automatically at a scheduled time
- **Manual Recording**, which records video manually by pressing the REC button
- **Event Recording** records video automatically when events occur.

The chapter also discusses the configuration settings including programming schedules, advanced camera and audio setup.

- ▶ 8. 6 Defining Programs
- ▶ 8. 7 Setting Up To Record

### 8. 6 Defining Programs

You can define 26 programs—labeled from A to Z—and specify particular frame rates, video quality and resolution for each. You then use these programs for both Manual and Schedule recording.

To set up a program :

1. Access the Program submenu, on the Record Setup menu of the OSD.



Figure 8.6.1 Program submenu on the Record Setup Menu

2. For Program option, select any letter from A-Z .
  - The settings for that program display. For each pre-set Program, the settings for all channels are identical. You can edit any setting within any Program.
  - Each channel has two recording modes: Normal and Event. Normal recording proceeds until an event occurs. When an event occurs, the recording shifts into the Event Recording settings you have specified.
  - For both Normal and Event recording, there are three settings: Resolution, Frames per Second and Quality. All are further explained in the table below.
3. Notice that you can highlight any setting on any channel (the background turns red) and then adjust the setting.

This table describes the settings :

Option	Description
CH (Channel)	The channel number
R (Resolution)	The recording resolution. Three resolutions are available: <ul style="list-style-type: none"> <li>· D1 (704 x 480)</li> <li>· Half D1 (704 x 240)</li> <li>· CIF (352 x 240)</li> </ul>
F (fps)	Frames per second, from 1 to 30fps The maximum frame rate varies depending on settings.
Q (Quality)	The recording quality: Q5, Q4, Q3, Q2, and Q1. For Event Recording, Q3 or higher is recommended.
Maximum R/F	This box displays the maximum frame rate available for the selected resolution. For example, if CIF 30fps appears in this box, it means that you can select up to 30fps for the CIF resolution of a selected channel. D1 30fps means that you can select up to 30fps for the D1 resolution.

### About Recording Performance & Capacity

Recording performance for the SVR-1670 is CIF 480fps for both Normal and Event Recording.

- When both recording modes are in effect, recording performance must not exceed CIF 480fps.
- The resolution and maximum frame rate vary depending on the number of enabled channels.
  - D1 (704 x 480) = 2 x Half D1 (704 x 240) = 4 x CIF (352 x 240)
  - 120 D1 compressed frames = 240 Half D1 compressed frames = 480 CIF compressed frames.

#### Event Settings Limitations

When every channel is set up to record Normally at CIF 30fps, the Event settings for the first channel are limited to CIF 30 fps, Half 15 fps, and D1 7fps.

If you want to set the Event settings to D1 30fps, the Normal settings of the other channels must be changed to total CIF 360fps or less.

#### Freeing Up Capacity

You can free up capacity by disabling unused channels. If a channel is disabled, its surplus CIF 30fps becomes available for other use.

- To disable a channel, go to the Display Setup menu on the OSD: Select the Channel Number, then for the Status option select Disable. If disabled, the channel is grayed-out on the Program menu and is uneditable.

Setting a channel's resolution to 0 fps does not free up space because the channel still uses 2-3 recording frames per second—even when set to 0fps—for tasks such as network communications.

#### When Events Occur in Multiple Channels Simultaneously

## Chapter 8. Scheduling and Recording Video

If events occur simultaneously in multiple channels and the Event settings exceeds the DVR's maximum recording performance :

- the Normal settings value is retained and
- the channels with events drop their Event frame rates settings to record the events.

However, the SVR-1670 provides D1 30 compressed frames for all channels; it can record programs at a manually selected resolution and frame rate at all times.

### 8.7 Setting Up To Record

You set up recording—either Manual or Schedule—from the Record Setup tab of the OSD.

Recording allows you to choose a program to record. The resolution, frame rate, and quality will vary depending on program you select.

#### Manual Recording

Manual Recording becomes activated when the recording mode is set to Manual & Event. Select a program and press the REC button to begin recording.

#### Schedule Recording Settings

Schedule Recording records video automatically at a scheduled time according to the chosen program settings. Set the recording mode to Schedule & Event then select a program for a scheduled date and time.

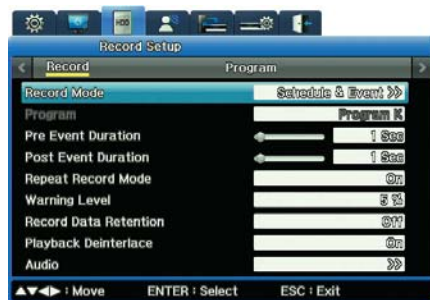

Figure 8.7.1 Record Submenu "Schedule & Event" Record Mode Setting

Option	Description
Record Mode	Schedule & Event or Manual & Event.

Schedule Or Program	If your record mode is Schedule & Event, you set your Schedule option here. If you record mode is Manual & Event, you select your Program here.
Pre Event Duration/ Post Event Duration	Set the Pre-Event Duration (1-5 seconds) and Post-Event duration (1-60 seconds) for recording an event.
Repeat Record Mode	If set to On, when there is no more space for recording to the hard disk, recording continues by overwriting the previously recorded data.
Warning Level	Set a level of disk capacity. When capacity for all disks connected to the DVR reaches this level, you receive a system warning.
Record Data Retention	How many days of recorded video you want kept available. For example, if you set this to 2 days, then a week later (when you have 7 days of video recorded) only the most recent 2 days of that video is available for playback. Settings are Off, 24 hours, and 2 to 31 days.
Playback Deinterlace	Only available when the recording resolution is set to Full D1 and Frame is set to 10 or below. For example, flickering will decrease if Full D1 video is paused.
Audio	Set Audio option such as Audio Recording, Gain, Sync Video Channel and so on.

#### What is Deinterlacing?

Deinterlacing is the process of converting interlaced video, which removes weaving traces generated when blending even and odd video lines to acquire smooth image.

### Setting Up a Schedule

When you select the Schedule submenu, you can set up a recording schedule for every hour of the day, every day of the week.

You can select one or more programs from among the 26 available, labeled from A to Z. Figure 8.3 below shows an example that uses only Program A.



Figure 8.7.2 Schedule submenu on Record Setup Menu

## Chapter 8. Scheduling and Recording Video

Option	Description
Index	1-50 different programs can be set. This allows you to set a variety of indexes for various days, and portions of days, for each week.
Day	The day of the week this Index is in affect.
Program	The Program you wish to use for the Index. To see the definition of any particular Program, go to Program submenu on the Record Setup menu of the OSD. Also refer to Defining Programs on page 69.
Time	Time of day. (In the grid, 0 means Midnight, 12 means Noon, and so on.)
Delete	Click the Delete button if you want to erase the Index entries from the grid.

### How to Set up a Schedule

1. In the data fields at the top of the submenu, enter the Index, the Day and the Program.
2. In the Time data field, enter the hour at which you want the program to begin recording, and the time at which you want data to cease recording.
  - You'll see the grid automatically display the hours, marked with the letter that designated the Program you chose.

Alternatively, you can set data in the grid, and the data will appear also in the data fields.

### A Brief Tutorial

1. On the Schedule submenu, select 1 for the Index, Sunday for the Day and A for the Program.
2. For time, select 00:00 – 20:00.
  - Notice that the grid displays an "A" on Sunday from Midnight until 20:00
3. Now select 2 for Index, Tuesday for Day and B for the Program.
4. Do not enter anything in the Time setting.
5. Using your mouse or the arrows on the front panel, navigate to the Tuesday row. Drag the mouse along the row, or click the arrow buttons. The Tuesday row populates with "B" program.
6. Now highlight a "B" in the Tuesday row.
7. Click anywhere in the Monday row, and the "B" will appear for that hour. Notice that the Index data field displays a new Index number for that new row.

### Deleting an Index Configuration

If you want to change an index's configuration after you've set it up, delete the Index to remove its current settings and erase it from the grid.

1. In the Index data field, select the Index.
2. Click the Delete button to delete it.
3. The Index configuration is erased. You can now set different configurations for that Index number.

※ TIP : Because the Index field is never empty, be sure to double-check that you are deleting the appropriate index. When you click the Delete button, whatever Index is displayed in the Index field will be deleted!

### Audio Setup

You setup Audio setting from the Audio option on the Record submenu.



Figure 8.7.3 Audio Channel submenu on the Record submenu

Option	Description
Audio Channel	Select a channel for audio. (This is not the channel for video; set that under Sync Video Channel.)
Audio Recording	Set Yes to have audio recorded for playback. (If you set it to Off, audio is still available for live video.)
Audio Gain	Adjust audio volume up or down.
Sync Video Channel	Select the video channel for which you are setting audio. By default, Channel 1 audio is outputted to Channel 1 video. But the audio channel can be set to Channel 1 and the synchronized video channel to Channel 8. Then, Channel 1 audio will be associated with Channel 8 video.
Audio Mix	On this submenu, set the audio for live feeds. <ul style="list-style-type: none"> <li>· Set to Mix On to have all audio available for output regardless of channel.</li> <li>· Select a specific channel to mix audio for that channel only.</li> </ul>



## Chapter 9. Camera and Monitor Display Setup

This chapter provides information about setting up the camera and monitor displays, and the screen layout, sequencing and other features available when viewing video images from cameras connected to the DVR.

The information is presented in these sections :

- ▶ 9. 1 Setting Up the Camera Display
- ▶ 9. 2 About Multichannel Screen Display
- ▶ 9. 3 Setting Up the Monitor Display
- ▶ 9. 4 Using Auto Sequencing
- ▶ 9. 5 Configuring Multi Display Layouts
- ▶ 9. 6 SPOT Monitor Settings

### 9. 1 Setting Up the Camera Display

You configure each camera connected to the unit using the Channel Display submenu. You can adjust Title, Status, Color, AGC, Brightness or Contrast for each of the cameras.



Use only one type of cameras—NTSC or PAL—to connect to the DVR.



Figure 9.1.1 Channel Display submenu on the Display Setup Menu

Option	Description
Channel Display	Assign the channel to a camera.
Title	Give a name to the camera for that channel. (This setting opens the On screen keyboard in which you can enter what you want to call the camera)
Status	Enable or disable a camera. To increase recording or network monitoring speed, be sure to disable unused channels.
Color	Select Color or B/W.
AGC (Auto Gain Control)	Set the automatic input range of video signals from a camera.
Brightness and Contrast	Adjust the brightness and contrast of a video.

### 9. 2 About Multichannel Screen Display

You can change your screen display from a single channel to various configurations on multiple channels on a split screen, up to all 16 channels on a split screen. (The default setting is 16 channels.)

You view multiple channels in various configurations on a split screen. For some of these, the channels are standard. For others, you set up which channels you want to appear.

4A — Channels 1, 2, 3 and 4

4B — Channels 5, 6, 7 and 8

4C — Channels 9, 10, 11 and 12

4D — Channels 13, 14, 15 and 16

4E — Any four channels you specify

9A — Channels 1, 2, 3, 4, 5, 6, 7, 8, 9

9B — Any nine channels you specify

10A — Any 10 channels you specify

#### Changing Screen Display

##### Shifting from multichannel to single channel

There are two ways to shift a multichannel display to single screen display of one channel :

- On the front panel, press the channel button. For example, press the “3” to view channel 3 in single-screen display.
- Hover the mouse cursor over the Channel image on the screen, and then left-click the mouse.
- Place your mouse cursor on the channel's image on screen, and left-click.

To return to split screen display, press the MULTI button or left-click the mouse.

##### Using the MULTI button on the front panel

On the front panel, press the MULTI button. Each time you press the button, the screen displays a different layout on the split screen :

Using the MULTI button on the Function menu.

1. Open the Function Menu and press the MULTI button .
2. A list of layout configuration options displays on screen. Select the layout you wish to see. For example, if you select “11,” channel 11 will display in full screen. If you select “9A,” the screen will split to show those 9 channels.
3. Press ESC to close the menu.

## Chapter 9. Camera and Monitor Display Setup

### 9.3 Setting Up the Monitor Display

You configure the display for each monitor using the Monitor submenu.



Figure 9.3.1 Monitor1 submenu on the Display Setup Menu

Option	Description
Covert Channel	Set any video channel you want to remain private and accessible only with specific permission. This channel will be hidden in live and playback modes.
Sequencing	Set the order in which monitor images display in an auto sequence.
Dwell Time	Set the amount of time a monitor image displays before the next image in the auto sequence appears.
Multi Display	Select the monitor images you want to appear for the split screen configurations 4E, 9B or 10A.
VGA Mode	Select a resolution for outputted video.
On Screen Display	Select information you want to show, superimposed on the video: · In case of the Live screen, you can set the time, channel name, event, recording status, HDD usage, remote control ID and text. · For video playback, you can set the time, command, channel name, event and text display.

### 9.4 Using Auto Sequencing

Changes the Live screen to the Auto Sequencing mode; a total of 16 different screens can be selected at the Sequencing menu. Each camera's image will display in the order you determine, for the amount of time you set (as the Dwell Time option). After each image displays in sequence, the rotation begins again and plays continuously until you stop it.

#### Setting up Auto Sequencing

You set up auto sequencing while entering settings for the options on the Monitor submenu of the Displays Settings menu :

1. On the Monitor submenu, select the Monitor for which you are setting options.
2. Select the Sequencing option. The Seq screen appears.

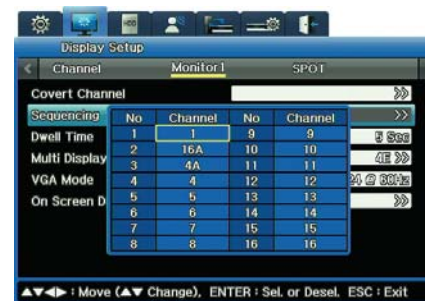

Figure 9.4.1 Sequencing submenu

3. Set the channel you want to appear first, second, third and so on in the sequence. You can set up to 16 channels (or less if you wish).

Figure 9.4.1 shows some defined sequences :

- First in sequence is Channel 1. Channel 1 will appear in single screen.
  - The second available order is 16A, displaying all 16 channels in split screens.
  - Third in sequence is 4A. The four 4A channels will appear in split screen.
4. Once you have setup the sequences, close the Seq submenu to return to the Monitor submenu to set the Dwell Time.
  5. For the Dwell Time option, enter the amount of time you want each channel to appear on the monitor (from 1 to 60 seconds).
    - You must set a Dwell Time to activate Auto Sequencing. If Dwell Time is set to Off, Auto Sequencing will not work.

#### Running Auto Sequencing

There are two ways to turn on Auto Sequencing so you can view it on your monitor :

- On the front panel, press the AUTO button.
- On the Function Key menu, press the Auto button .

To stop Auto Sequencing, press either button again. (This stops it from running; it does not erase your settings.)

## Chapter 9. Camera and Monitor Display Setup

### 9.5 Configuring Multi Display Layouts

You can configure which channels you want to display in the 4E, 9B and 10A multichannel setting. You set up multi display while entering settings for the options on the Monitor submenu of the Displays Settings menu :

1. On the Monitor submenu, select the Monitor for which you are setting options.
2. For the Multi Display option, select first the configuration you want to set : 4E, 9B or 10A.
3. Next, access the Multi Display submenu.
  - The Multi Display submenu shows grid appropriate to the configuration you selected: split by 4, split by 9, or split by 10.
4. Click in the Channel's box for each channel you want to include in the multi display. For example, if you are setting up a 9B, select 9 channels.
  - The grid displays where the channel's image will appear.
  - The order in which you click the boxes is the order in which the channels appear on the grid.



Figure 9.5.1 Multi Display Layouts

### 9.6 SPOT Monitor Settings

Configures the spot out monitor. SPOT Monitor can be used for realtime viewing and recording, and it is not used for playback and video search.

Option	Description
Covert Channel	Set any video channel you want to remain private and accessible only with specific permission. This channel will be hidden in live and playback modes.
Sequencing	Set the order in which monitor images display in an auto sequence.
Dwell Time	Set the amount of time a monitor image displays before the next image in the auto sequence appears.

## Chapter 10. Camera Commands

This chapter explains how you execute various camera commands, while viewing live video, from controls on the FUNC menu and on the PTZ menu.

The information is presented in these sections :

- ▶ 10.1 Camera Commands from the FUNC Menu
- ▶ 10.2 Pan/Tilt/Zoom Commands

### 10.1 Camera Commands from the FUNC Key Menu

While watching a live video, the FUNC menu can be used to control the PTZ operation or enlarge the image of the camera.

#### Zooming In on Live Video

When viewing a single channel in full-screen mode, you can zoom in on the image. Zooming allows you to move in 18 levels horizontally and 12 levels vertically.

1. Press FUNC to access the Function menu.
2. Select the Zoom button.
  - The camera location defaults to the center of the screen.
3. Select the "Plus" button and press ENTER or left-click the video pane.
  - To reposition the image, use the navigation keys on the FUNC menu :



### 10.2 Pan/Tilt/Zoom Commands

If you connect a PTZ controller to your PTZ camera, you can control pan, tilt and zoom while watching live video. Once you have the controller configured, you can access and work with the PTZ menu.

#### Accessing the PTZ Menu

1. Press the channel button to select the channel you wish to view.
2. Press either the PTZ button or the FUNC button on the front panel.
3. The PTZ menu appears, superimposed on the camera's image.

## Chapter 10. Camera Commands



Figure 10.2.1 PTZ Menu

Option	Description
P/T	P/T stands for Pan/Tilt. Select this button to operate the Pan or Tilt features of the camera.
Z/F	Z/F stands for Zoom/Focus. Select this button to operate the Zoom or Focus features of the camera.
Menu	Opens the PTZ menu. To exit the menu, press the PTZ button on the front panel.
Preset with Load and Save	You can define where and how you want the camera to position itself.
Aux with On and Off	Aux stands for Auxiliary, meaning special functions of your particular brand or model of PTZ camera. For this option, you enter the number that corresponds to the particular auxiliary function you want to use.

### Using Pan/Tilt

To pan or tilt a camera, select P/T from the PTZ menu.

- To pan the camera, press the left or right arrow key on the front panel, or click the left or right area of the screen.
- To tilt the camera, press the up or down arrow key on the front panel or click the top or bottom of the screen.

### Using Zoom/Focus

To zoom or focus a camera, select Z/F from the PTZ menu.

- Use the mouse of the buttons on the front panel to zoom or focus on the image.

### Loading and Saving Presets

A preset is a defined camera position; you preset the camera angle and focus. You must first setup camera preset with PTZ attached to each channel.

**To activate a preset location :**

1. Go to the PTZ menu.

2. Select a preset number.
3. Select Load and then press the ENTER button.

The camera will pan, tilt or zoom to the specifications of that preset condition.

**To save a position—in other words, to make it a preset :**

1. Pan, tilt and zoom the camera until it adjusted to the position you want to save.
2. Go to the PTZ menu.
3. In the Preset field, select a preset number.
4. Select Save and then press the ENTER button.

### Setting Auxiliary Functions

The Auxiliary feature is used for special functions of a PTZ camera. Specific features depend on the particular make and model of camera you are using. Refer to the manufacturer's documentation for information on auxiliary functions.

**To use the Auxiliary function :**

1. Go to the PTZ menu.
2. To turn on the Auxiliary function, select On.
3. Set up to 16 Auxiliary numbers.
4. To turn off an Auxiliary function, select the Auxiliary number you wish to turn off and select Off.

### Setting the Console Menu

If the PTZ camera is connected to the DVR with the Samsung SPD protocol, you can configure the camera using its console menu.

**To access a camera's console menu :**

1. Use the navigation keys on the front panel to select camera settings.
2. Press ENTER to accept your settings.

# Chapter 11. Working with Recorded Video

This chapter discusses working with video that has been recorded on the DVR.

The chapter covers these topics :

- ▶ 11. 1 Various Playback Options.
- ▶ 11. 2 Searching for Recorded Video
- ▶ 11. 3 About Copying Video

## 11. 1 Various Playback Options

To begin playback of recorded video on a 16-channel split screen, either :

- Press the **PLAY** button on the DVR's front panel;
- Press the **Play** button on the remote control;
- On the **Function Key** menu, press the **Play** button.

### Controlling Playback with Function Menu

Use these keys on the Function menu to control playback :

Option	Description
Play ▶	Plays a video at 1x speed. · Press PLAY in monitor mode to play multiple videos. · Press PLAY to play recorded videos from the last playback timestamp.
Pause	Press to pause video playback.
Stop ■	Press to stops video playback.
Fwd ▶▶	To play a recorded video from 1 minute prior to the ending, press the High-Speed Forward Play button while on the Live screen. Press FWD on the Function menu to change the playback speed. Each time you press FWD the playback speed changes in this sequence: x1, x2, x4, x8, x16, x32, x64, x1/2.
Rew ◀◀	To play a recorded video backward from the last frame, press the High-Speed Backward Play button while on the Live screen. Each time you press REW, the video plays in reverse playback speed (in the order of x1, x2, x4, x8, x16, x32, x64, x1/2)
1/2 ◀	Press 1/2 Rewind to play the video at half speed.
▶ 1/2	Press 1/2 Forward to play the video in reverse at half speed.
Step Forward	Press PAUSE, then press FWD or rotate the jog to play the video frame by frame. Press the PLAY button to return to normal playback.
Step Rewind	Press PAUSE, then press REW or rotate the jog to play the video frame by frame. Press the PLAY button to return to normal playback.
Capture	To capture the playback to a USB memory, press PAUSE and then press AUTO button on the front panel.
BookMark	Press the PTZ button on the front panel to add a bookmark while playing back.

### Controlling Playback with Remote Control

If you use the remote control device, use these keys to playback video :

Option	Description
Play ▶	Plays a video at 1x speed.
Pause	Press to pause video playback. Press Enter to resume play.
Stop ■	Press to stops video playback.
Fwd ▶▶	Press FWD while viewing a live feed to play the video recorded one minute before the current live time.
Rew ◀◀	Press REW while viewing a live feed to play the video in reverse from the last recorded frame.
Step Forward ▶▶	Plays video frame by frame.
Step Rewind ◀◀	Plays video frame by frame in reverse.
Fast Forward ▶▶▶	Forwards video rapidly.
Rewind ◀◀◀	Rewinds video rapidly.

## 11. 2 Searching for Recorded Video

You can search for recorded video by Time, Calendar, Event and Thumbnail. To go to Search mode, either :

- Press the **SEARCH** button on the front panel.
- Press the **SEARCH** key on the remote control.
- On the **Function Key** menu, click the **Search** button.

The Search menu appears, and from it you can select the type of search you wish to perform.

When the time has been changed:

If the time has been changed, searching should be based on the changed time.

- If only GMT/DST was changed, timestamp of recorded video searched and played remains as before the change (recorded time).



Figure 11.2.1 Search Menu

# Chapter 11. Working with Recorded Video

## Searching by Time

1. Select Time from the Search Menu.



Figure 11.2.2 Time Search Menu

2. Notice that the Start-REC time and End-REC Time field show the range within which you can search.
3. In the Search Time selection, enter the date and time you want to search for.
4. Select Search to start the search.

## Searching by Calendar Date

1. Select Calendar from the Search Menu.



Figure 11.2.3 Calendar Search Menu

2. In the Year field select the year.
3. In the Month field (to the right of Year), select the Month.
4. In the month grid, select the date within that month. (If a date in underlined in pink, video was recorded on that date.)

5. In the time period grid (at the right), select the time. The grid is marked by hours: 0 is Midnight, 12 is noon, and so on.) If an hour is marked in sky blue, video was recorded manually; if an hour is marked in pink, video was recorded by event in that hour.
6. Select the time, press the ENTER button, and select the minute on the appeared popup. The grid is marked by minutes.
7. Press the ENTER button to start playback of the video for the date and time you've selected.

## Searching by Event

You can search for events that occurred at a specific time down to the second.

1. Select Event from the Search Menu.



Figure 11.2.4 Event Search Menu

2. Notice that the Start-REC time and End-REC Time field show the range within which you can search.
3. For the Search Start Time, enter the date and time on which you want to begin the search.
4. For the Search End Time, enter the date and time on which you want search to.
5. For Event Channel, select on which channels you want to search.
6. For Event Type, select which type of event you want to search for—Text, Video Loss, Sensor, Motion Detection, or All
7. Select Search to start the search.
8. A list will appear with the search results. Select an item from the list to start playback.

# Chapter 11. Working with Recorded Video

## 11.3 About Copying Video

The SVR-1670 supports the following types of copy media :

- **CD/DVD** : You can copy video to a CD or DVD. We recommend you use the 16x CDs or DVDs from Mitsubishi, TDK, Imation and Sony.
- **STK** : You can copy videos of multiple video channels to a USB storage device and playback using the Slim Player. Copying function is available for users of appropriate security permission.
- **AVI** : You can copy saved data in AVI format to a USB storage device and play back.

### Copying Video

To begin copying, either :

- Press the COPY button on the front panel.
- Press the COPY key on the remote control.
- On the Function Key menu, select the Copy button.

Then enter the appropriate selections for each option on the Copy menu.



Figure 11.3.1 Copy Menu

Option	Description
Type	Select either one of CD/DVD, STK and AVI.
Channel	For STK, select the channel to be copied after opening the copy channel. (AVI and CD/DVD formats do not support per-channel backup.)
Slim player	Select whether to copy the Slim Player or not.
From	Enter the start date and time of the video you want to copy.
To or Duration	Enter the ending date and time of the video to be copied.

Bookmark	While playing a video, bookmark a scene to enable the bookmark feature in the Copy window.
Select Disk	This option will show the media currently inserted into your DVR. Select the disk you want to copy to.
FAT32 Format	If you are using unformatted USB or HDDs in FAT32, you must format them before copying. Select the FAT32 Format button to format them. (This applies only to STK copying, not to CD/DVDs.)
Start	To begin the copying, select the Start button.

For following cases, the tray will not open automatically after the CD/DVD copy failure:

1. When there is no saved data between the specified backup starting and ending time.
2. When the inserted CD/DVD media already contains the recording.
3. When the inserted media is not supported.



Do not interrupt the copying process once it begins. If the copy process is not 100% complete, the copied video will not play properly.

## Chapter 12. Using Web Viewer

This chapter provides information about Web Viewer, an online application which serves as a complement to the DVR. With Web Viewer, you can view visual live feeds and play recorded data over the Internet.

The information is presented in these sections :

- ▶ 12. 1 System Requirements
- ▶ 12. 2 Starting Web Viewer
- ▶ 12. 3 Monitoring Live Video
- ▶ 12. 4 Working with Recording Video

### 12. 1 System Requirements

To use Web View, we recommend that your system meet these requirements :

- CPU : Core2duo E6750 or higher  
(Intel Pentium 4 / 3.0GHz is the minimum acceptable)
- Operating System : Windows XP Professional
- Main Memory : 2GB or more (1 GB is the minimum acceptable)
- Video Memory : 512MB or more (256 MB is the minimum acceptable)
- Display Resolution : 1280 x 1024 (32bit color) or higher
- HDD : 1GB or more
- Other : DirectX 9.0 or higher, Windows Internet Explorer 6.0 or higher

### 12. 2 Starting Web Viewer

Follow these steps to start Web Viewer :

1. Close all open programs.
2. Open your browser and enter the IP address and port assigned to the DVR, for example: `http://xxx.xxx.x.xxx:4000`.  
The port value default is 4000. Use this default unless your system administrator has changed the value, in which case use that new value.
3. The Login screen appears.
  - If you do not have ActiveX installed on your computer, you will be prompted to install it. The ActiveX program is required to run Web Viewer.
4. At the Login screen, enter your ID and password.
  - The default ID is admin.
  - The default password is 11111111 (eight ones).
5. Click Login.

### 12. 3 Monitoring

If you are logging into Web Viewer for the first time, or if you click the **Monitoring** button at the top of Web Viewer, you will be directed to the Monitoring Page where you can view the video feeds from the cameras connected to your product.

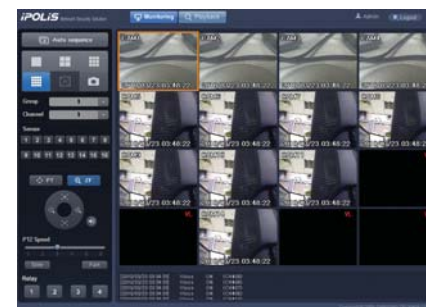





Figure 12.3.1 The monitoring page screen that displays the current video

#### Splitting Screen and Changing & Playing Channels

You can select the number of video feeds to simultaneously display on-screen by clicking the  button in the upper left of the screen. 1, 4, 9, and 16 channels are available to monitor simultaneously.

When displaying 1, 4, 9, or 16 channels at the same time, the channels are displayed in groups to manage visibility. For example, if you are monitoring 9 channels simultaneously, then channels 1~9 are displayed in group 1, and channels 10~16 are displayed in group 2.  is used to select the group or channel you want monitoring. To watch video in all channels in sequential order, click  button to activate the Auto Sequence option that cycles through videos in different channels at 7-second intervals.

The logs for the current channel are at the bottom of the screen: event (MD, V-Loss), main unit sensor, and relay event. To check the logs, move the scroll on the right side of the window up or down. The event icon displays on the video of channels where MD, V-Loss and Sensor occur. When clicking on a video channel, the selected screen is outlined in orange. To save the  selected screen as a JPG file, press the left button on the page while the orange outline is present.



## Chapter 12. Using Web Viewer

### Sensor Status





The  window on the left side of the screen displays the status of sensors.

### PTZ Control

When clicking on a video channel, the selected screen is outlined in orange. To control the camera PTZ (Pan, Tilt, Zoom) operations of the selected channel, press the left button on the page while the orange outline is present.



 changes the direction that the camera faces. Click the button to display the circular button shown on the right. Click a direction on the circular button to pan the camera in that direction.



 adjusts the zoom and focus of a camera. Click the button to display the circular button, shown on the right. Click  and  to zoom in and out; click  and  to adjust the focus.



Click the  button next to the circular button to play the audio feed from the selected channel. The effect of this button is identical to the Audio option in the right-click context menu.

You can adjust the PTZ speed with the slider at the bottom of the page. A total of 6 different PTZ speed levels are available. Click  to decrease the PTZ speed by one level, and  to increase it by one. "1" is the slowest PTZ speed setting, and "6" is the fastest.



**Note** The PTZ control and preset options are only compatible with PTZ enabled cameras, and the DVR must be configured with the correct settings.

### Control Relay

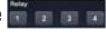
The  window on the left side of the screen displays the status of currently activated relays. Use the number buttons in the window to control corresponding relays.

## Chapter 12. Using Web Viewer

### 12. 4 Playback

Click **Playback** at the top of the screen to display the Playback screen. This screen lets you watch saved videos. Playback uses the Time Search option.

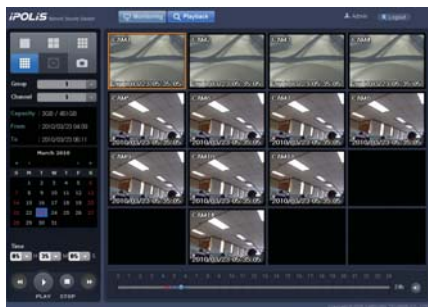



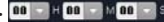







Figure 12.4.1 The playback screen that provides time based search

#### Splitting Screen and Changing & Playing Channels

You can select the number of video feeds to simultaneously display on-screen by clicking the  button in the upper left of the screen. 1, 4, 9, and 16 channels are available to play video simultaneously.

When playing video from 1, 4, 9, or 16 channels, the channels are displayed in groups to manage visibility. For example, if you are viewing 9 channels simultaneously, then channels 1~9 are displayed in group 1, and channels 10~16 are displayed in group 2. Use  to select and play video from a desired group and channel.

- To watch a video conveniently, select a date on the calendar under the Channel button. Dates with videos available are displayed in blue, e.g. 
-  Time Area : Select time, and then press the PLAY button to play a video that is recorded at the selected time.
-  REW &  FWD Buttons : While playing a video, these buttons are used to display the play direction and speed. The adjusted play speeds are 1x, 2x, 4x, and 8x backward and forward. Each time the REW or FWD button is clicked, the play speed changes by one level.
-  PLAY Button: Plays a video. While a video is playing, it changes to the  (PAUSE) button. Clicking the PAUSE button pauses the current video.
-  Stop Button: Stops a video.

- Move the  knob on the slider below the playback screen to seek to a specific video time. Times with video available are highlighted in blue on the time slider while times with event video are in red.

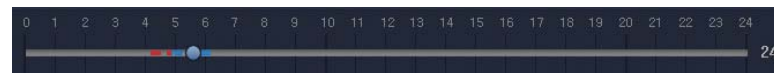

# Appendix A. Specifications of the SVR-1670

## Specifications of the SVR-1670

### Display

1. Video
  - a. Inputs 16 composite video 1 Vpp, 75 ohm automatic termination
  - b. Resolution 704 x 480 for NTSC; 704 x 576 for PAL
2. Live
  - a. Frame rate 480fps for NTSC; 400fps for PAL
  - b. Resolution : 704 x 480 for NTSC; 704 x 576 for PAL
  - c. Multi Screen 1/4/9/10/16

### Performance

1. Recording
  - a. Compression H.264
  - b. Recording Rate
    - NTSC : 120 fps in 704 X 480, 240 fps 704 X 240, 480 fps in 352 X 240
    - PAL : 100 fps in 704 x 576, 200 fps in 704 x 288, 400 fps in 352 x 288
  - c. Mode Manual, Schedule, Event, Emergency
  - d. Overwrite modes Continuous
  - e. Pre-Event Up to 5 sec.
  - f. Post-Event Up to 60 sec.
2. Search & Playback
  - a. Search mode Date/time, Event, Calendar, Bookmark Text (Exclusive viewer)
  - b. Frame rate 480 fps D1 for NTSC, 400 fps D1 for PAL
  - c. Playback function REW, FWD, Frame advance
3. Network
  - a. Bandwidth control Automatic
  - b. Multi Stream H.264/JPEG
  - c. Number of IP addresses allowed for remote access Supports 1 for Playback, 1 for backup and up to 64 LIVE channels simultaneously. (Allows up to 2 IP connections at the same time regardless of the number of users)
  - d. Protocol support TCP/IP, DHCP, DNS, DDNS, HTTP, ARP, ICMP and NTP
  - e. Monitoring Built-in Web server
4. Storage

- a. Max. Capacity 12 TB
- b. Internal HDD 4 HDD
- c. External HDD External HDD External eSATA 1 port
- d. Back -up DVD Writer : DVD+R/DVD-R/CD-R  
File Format : BMP, AVI, Proprietary format / JPG (Exclusive viewer)
5. Security
  - a. Password Protection 10 User Level

### Interface

1. Monitors
  - a. VGA Output RGB 800 x 600, 1024 x 768, 1280 x 1024 resolution
  - b. Main Output 1 BNC, Multi-screen, Menu, Playback
  - c. Spot Output 1 BNC Spot (event pop-up, display switching)
  - d. Loop Outputs 16 Output
2. Audio
  - a. Inputs 16 Line input, 30k ohm, 1Vpp
  - b. Output 1 Line output, 1Vpp
  - c. Compression ADPCM
  - d. Sampling rate 16kHz
3. Alarm
  - a. Inputs 16 Input, NO/NC
  - b. Outputs 4 relay outputs, NO/NC
  - c. Remote notification Notification via e-mail
4. Connections
  - a. Ethernet RJ45 10/100/1,000 Base-T
  - b. Serial interface Serial interface RS-232C
  - c. PTZ control interface RS-485/RS-422
  - d. PTZ Keyboard RS-485
  - e. USB 2 USB 2.0 ports
  - f. eSATA eSATA 1 External eSATA ports
  - g. Application Support ATM/POS, Mouse, Remote Controller
5. Dome Protocols
  - a. Supported PTZ cameras Samsung-T (Samsung Techwin), Pelco D, Pelco P, Coaxitron, Panasonic, Samsung-E (Samsung Electronics), VICON, Honeywell, AD

## Appendix A. Specifications of the SVR-1670

### General

1. Electrical
  - a. Input Voltage 100 to 240 VAC; 50/60 Hz
  - b. Power consumption Max. 50 W with 1x HDD
2. Environmental
  - a. Operating Temp 32°F ~ +104°F(+5°C ~ +40°C)
  - b. Operating Humidity 0%RH ~ 60%RH
3. Mechanical
  - a. Dimensions 17.5 x 3.5 x 16 inch (445 x 88 x 405 mm)
  - b. Weight (1x hard disks) Approx. 22.1 lb (10 kg)
  - c. Rack mount kit For mounting one unit in an EIA 19 inch rack

## Appendix B. Recording Program Default Settings

The following table lists the default settings for recording programs.

### SVR-1670 Recording Programs

NTSC	Normal			Event		
	Resolution	FPS	Quality	Resolution	FPS	Quality
A	D1	7	Q5	D1	7	Q5
B	D1	5	Q5	D1	7	Q5
C	D1	5	Q4	D1	7	Q5
D	D1	4	Q5	D1	5	Q5
E	D1	5	Q4	D1	7	Q5
F	D1	4	Q4	D1	5	Q4
G	D1	1	Q4	D1	4	Q4
H	D1	0	Q4	D1	7	Q5
I	Half	10	Q5	Half	15	Q5
J	Half	5	Q5	Half	15	Q5
K	Half	4	Q5	Half	10	Q5
L	Half	10	Q4	Half	15	Q5

NTSC	Normal			Event		
	Resolution	FPS	Quality	Resolution	FPS	Quality
M	Half	10	Q4	Half	15	Q5
N	Half	5	Q4	Half	10	Q5
O	Half	5	Q4	Half	10	Q4
P	Half	4	Q4	Half	5	Q4
Q	Half	1	Q4	Half	4	Q4
R	Half	0	Q4	Half	7	Q5
S	CIF	30	Q5	CIF	30	Q5
T	CIF	20	Q5	CIF	30	Q5
U	CIF	20	Q4	CIF	20	Q5
V	CIF	10	Q4	CIF	15	Q4
W	CIF	25	Q3	CIF	25	Q5
X	CIF	10	Q3	CIF	10	Q4
Y	CIF	1	Q4	CIF	4	Q4
Z	CIF	0	Q4	CIF	7	Q5

### SVR-1670 Recording Programs

PAL	Normal			Event		
	Resolution	FPS	Quality	Resolution	FPS	Quality
A	D1	6	Q5	D1	6	Q5
B	D1	4	Q5	D1	6	Q5
C	D1	4	Q4	D1	6	Q5
D	D1	3	Q5	D1	4	Q5
E	D1	4	Q4	D1	6	Q5
F	D1	3	Q4	D1	4	Q4
G	D1	1	Q4	D1	3	Q4
H	D1	0	Q4	D1	6	Q5
I	Half	8	Q5	Half	12	Q5
J	Half	4	Q5	Half	12	Q5
K	Half	3	Q5	Half	8	Q5
L	Half	8	Q4	Half	12	Q5
M	Half	8	Q4	Half	12	Q5

## Appendix B. Recording Program Default Settings

PAL	Normal			Event		
	Resolution	FPS	Quality	Resolution	FPS	Quality
N	Half	4	Q4	Half	8	Q5
O	Half	4	Q4	Half	8	Q4
P	Half	3	Q4	Half	4	Q4
Q	Half	1	Q4	Half	3	Q4
R	Half	0	Q4	Half	6	Q5
S	CIF	25	Q5	CIF	25	Q5
T	CIF	16	Q5	CIF	25	Q5
U	CIF	16	Q4	CIF	16	Q5
V	CIF	8	Q4	CIF	12	Q4
W	CIF	21	Q3	CIF	21	Q5
X	CIF	8	Q3	CIF	8	Q4
Y	CIF	1	Q4	CIF	3	Q4
Z	CIF	0	Q4	CIF	6	Q5

## Appendix C. Supported PTZ Controllers and Protocols

This table lists the PTZ controllers that can be used with the SVR 1670 DVR.  
Some protocols are expected to apply at a later date.

Manufacturer	Product
SAMSUNG TECHWIN	· Samsung-T · SCC-3100A
PELCO	· PELCO (P) · PELCO (D)
HONEYWELL	· Honeywell
AD	· AD speedDome® Ultra 8
SAMSUNG ELECTRONICS	· Samsung-E
PANASONIC	· Panasonic WV-CS950
VICON	· VICON

## Appendix D. Compatible HDD List

Western Digital	
Capacity	Model
2TB	WD20EVDS
1TB	WD10EVS
500GB	WD5000AVVS
320GB	WD3200AVVS

## Appendix E. Compatible Media List

DVD-R/+R manufacture	CD-R manufacture	USB manufacture
Mitsubishi(Exhortation 16X)	Mitsubishi(Exhortation 52X)	Sandisk
Imation(Exhortation 16X)	Imation(Exhortation 52X)	Sony
Sony(Exhortation 16X)	Sony(Exhortation 48X)	
Verbatim(Exhortation 16X)	Verbatim(Exhortation 52X)	

## Appendix F. Factory Default Settings

This appendix contains default systems settings. Use this list to identify default settings as they are set when the DVR is shipped from the factory. You can change these settings, on the OSD menu, to your preferred settings.

Quick Setup	Option		Setting
	Record Mode	ii	Schedule & Event
	Program		Program K
	Event Check		Off
	Language		English
	Time	ii	>>
		Time Zone	UTC 00:00 Dublin
		Daylight Saving	Off
		Date Format	MM/DD/YY
		Time	Current time
	Audio Recording		Off

Display Setup	Option		Setting
Channel	Channel Display		Ch1
	Title		Cam 1
	Status		Enable
	Color		Color
	AGC		Enable
	Brightness		0
	Contrast		0
Monitor1	Covert Channel		Deselect All
	Sequencing		Number 1 is set to Channel 1 and Number 2 is set to Channel 2 in order.
	Dwell Time		5 sec
	Multi Display	4E	Channels 1, 2, 3, 4
	VGA Mode		1280×1024 @ 60Hz
	On Screen Display		Select All
SPOT	Covert Channel		Deselect all
	Sequencing		Number 1 is set to Channel 1 and Number 2 is set to Channel 2 in order.
	Dwell Time		5 sec

## Appendix F. Factory Default Settings

Record Setup	Options		Settings
Record	Record Mode		Schedule & Event
		Schedule	Not Set All
	Pre Event Duration		1 sec
	Post Event Duration		1 sec.
	Repeat Record Mode		On
	Warning Level	ii	5%
	Record Data Retention		Off
	Playback Deinterlace		Off
	Audio		>>
		Audio	Audio Channel 1
		Audio Recording	Off
		Audio Gain	0
		Sync Video Channel	Ch 1
		Audio Mix	Mix On
Program	A ~ Z	ii	CIF, 0fps, Q1

Event Setup	Options		Settings
Event	Event Check		Off
	Event Screen / Dwell time 1	Monitor 1	Off
	Event Screen / Dwell time 2	Monitor 2	Off
	Event Action		Relay 1
	Action Duration		10 sec.
	Normal Event Source		Deselect All
	System Event Source		HDD Fail
	E-Mail		>>
Normal	MD		MD1
	Sensitivity		Lowest
	Area		Set All
	Sensor		Sensor1, N.O.
	Text		>>
		Recording	Off
		Device	Manual
		Sync Text With	Ch 1

## Appendix F. Factory Default Settings

Event Setup	Options		Settings
		Seek Header	Off
		Header 1	header1
		Header 2	header2
		Delimiter	0DOA
		Timeout (ms)	1000
		Lines	20
Preset	Channel Number		Ch 1
	Preset		MD1, Not Set
D-I/O	Select D-I/O		D-I/O1
	Direction		Out
	Type		Sensor

Network Setup	Options		Settings
Network	Type		Ethernet
	DHCP		Off
	IP address		Default IP
	Net Mask		Default NM
	Gateway		Default GW
	DNS1		0.0.0.0
	Additional DNS		0.0.0.0
	Port		4000
	Bandwidth Limit (Kbps)		0000
xDSL	ID	ii	Guest
	Password		*****
	Port		4000
	Bandwidth Limit (Kbps)		0000
	Status		xDSL not connected.
DDNS	Interval		Off
	Server		www.samsungipolis.com
	ID		None
	Password		None
	Status		DDNS not Registered



## Appendix F. Factory Default Settings

Network Setup	Options		Settings
NTP	Sync with NTP		Off
	NTP Mode		Client
	NTP Server Loc.	ii	Public
	NTP Local Server IP		255.255.255.255
	Interval		1 hour
	Remote	Remote Keyboard ID	
Remote Controller ID			All
Remote Configuration Setup			Enable
Remote Relay			Enable
Serial			Com1 >>
		Device	None
		Interface	RS232
		Baud Rate	9600
		Parity Bit	None
		Stop Bit	1
		Data Bit	8
PTZ			CH1 >>
		Port	None
		Protocol	Samsung-T
	Camera ID	0	
	Idle Time	Off	
IP Filter	Use		Off
	Default Policy		Deny

## Appendix F. Factory Default Settings

System Setup	Options		Setting
System	Language		English
	Key Buzzer		On
	Default		>>
	Load/Save Configuration		Load, >>
	Firmware Update		>>
	DVR Alias		DVR0
	System Log		>>
	Time		>>
	Disk	Disk Manager	
Disk Status			>>
Password	Change P/W		Default value
	Menu		Check X, Admin and User : 0
	PTZ		Check X, Admin and User : 0
	Relay Off		Check X, Admin and User : 0
	Playback		Check X, Admin and User : 0
	Power Off		Check X, Admin and User : 0
	Power On		Check X, Admin and User : 0
	Copy		Check X, Admin and User : 0
	N/MIC		Check X, Admin and User : 0

Exit			
Exit	Save		>>
	Do not save		>>

## Appendix G. Glossary

Term	Definition
4 CIF	A videoconferencing format that specifies data rates of 30 fps with each frame containing 704 horizontal lines by 576 vertical lines. 4CIF is 4 times the size of CIF. See CIF.
AC	Alternating Current, a form of electricity for powering an appliance. The SVR-1670 supports either AC or DC current.
AC/DC	A power supply offering Alternating Current and Direct Current.
Access Control	An external device for which the SVR-1670 can retrieve text data related to recorded events. Access control devices provide data related to building ingress and egress.
Alarm	An input signal event that triggers the opening or closing of a switch that is connected to a video channel on a DVR. A corresponding response varies depending on equipment type. Most commonly, a switcher "holds" on the camera corresponding to the alarm input.
Alarming	The ability of CCTV equipment to respond to an input signal, normally a simple switch closure. The response varies depending on equipment type, the most common of which is for a switcher to 'hold' on the camera corresponding to the alarm input.
Analog	A signal in which any level is represented by a directly proportional voltage; not digital.
ATM	An ATM (Automated Teller Machine) provides data related to bank transactions. It is an external device for which the SVR-1670 can retrieve text data related to recorded events.
Auto Sequencing/ Sequencing	The act of displaying video from every camera, or a group of cameras, that is connected to a DVR. After a predetermined interval, the DVR displays video from the next camera in sequence. If 16 channels are connected, the DVR briefly displays video from cameras 1 through 16 consecutively.
Automatic Brightness Control	The self-acting mechanism in display devices which controls brightness of the device as a function of ambient light.
Automatic Gain Control (AGC)	An electronic circuit that automatically adjusts the gain of a signal as a function of its input or other specified parameter. For the SVR-1670, AGC controls the input range of video signals from a camera.
Auto-Terminating	Feature whereby the equipment automatically selects the correct termination depending on whether the video output BNC is connected.
AVI	Audio Video Interleave. A standard video file format introduced by Microsoft. AVI files can contain both audio and video, which can be played back synchronously.
Brightness	A function of ambient light.
CD-R	Compact-disc recordable. A CD-R disc can be written once and then read many times.

Term	Definition
CIF	Common Intermediate Format. A videoconferencing format that specifies data rates of 30 fps with each frame containing 352 horizontal lines and 288 vertical lines. Other related file formats include : · QCIF (176 x 144) QCIF stands for Quarter CIF. · 4CIF (704 x 576) 4CIF is 4 times the size of CIF.
Continuous recording	The act of recording video continuously without regard to alarm events or other settings. When a DVR records continuously, it overwrites older video unless that video has been marked for retention.
Contrast	The range of light and dark values in a picture or the ratio between the maximum and the minimum brightness values.
Covert channel	A video channel that can be recorded, but whose video can be viewed only by users with the appropriate permissions.
D1/half D1	A type of video resolution. · D1 resolution is recorded at 704 x 480 horizontal and vertical lines. · Half D1 is recorded at 704 x 240 lines.
Data retention	The length of time that recorded video is stored on internal hard disk storage before it is overwritten.
DST	During Daylight Saving Time clocks are advanced by one hour, in most areas of the United States. Setting on the SVR-1670 can adjust time to allow for DST.
DC	Direct Current. A unidirectional electric current that provides power to appliances. The SVR-1670 supports both DC and AC power.
D-I/O	Digital Input/Output connections. Also referred to as Digital I/O.
Duration	Refers to any of the following recording periods: · Total length of recorded video that is stored on the hard disk; · Length of a specific recorded event including pre- and post-sensor recording; · Length of the video that should be copied to external media or storage.
DVD-R	Digital video disc-recordable. A DVD-R disc can be written once and then read many times.
Dwell time	A variable length of time that a channel is displayed on a monitor before another channel is displayed. See also Auto Sequencing.
eSATA	External serial ATA hard disk drive. Supported by the SVR-1670.
Event recording	The act of recording video based on the occurrence of a sensor event or motion detection. When the SVR-1670 is set to record video based on an event, it records the video along with pre- and post-sensor activity based on the configured settings.
Event screen	A group of cameras that are assigned to each other and are displayed simultaneously upon the occurrence of an alarmed event.

## Appendix G. Glossary

Term	Definition
FAT 32 Format	File allocation table (32 bit generation). Replaces and overcomes limitations of previous versions. The SVR-1670 supports the FAT 32 operating system.
FCC	Federal Communications Commission. The governing body in the United States that creates and enforces compliance regulations regarding electronic equipment that radiates radio frequency energy.
Firmware	The programming written to the ROM portion of a small memory chip and that runs programs on the SVR-1670. (Programs stored on firmware are usually small and do not require the storage capacity found in large computer hard disk drives.)
Focus	The focal point of a lens. An adjustment to the lens optics improves the clarity of the picture.
FPS	Frames per second. The number of frames that are displayed or recorded each second.
Gain	The increase in strength of a video signal. See also, automatic gain control (AGC).
GUI	Graphical User Interface.
HDD	An internal hard disk drive.
Interlace/deinterlace	Combining even and odd fields to improve the picture quality of a video signal. Deinterlacing is the process of converting interlaced video to a non-interlaced form.
IPS	Images per second. Same as FPS.
Jog/Shuttle	The circular control on the front panel of the SVR-1670 that is used to adjust menu settings, navigate through on-screen menus and control PTZ cameras. The jog/shuttle can be pressed in any of four directions up, down, right, and left.
LED	A series of light-emitting diodes located on the front panel of the SVR-1670 that indicate channel and data input status.
Loop out	Abbreviation for a loop output connection terminal on a DVR, for each camera channel.
Manual recording	The act of recording video by selecting the record function while viewing live video.
Max R/F	The maximum frames per second that can be recorded at the selected video resolution.
Motion detection	The act of recording video based on the presence of motion in a defined area in the camera field of view.
H.264	A data compression standard digital video codec with a very high data compression rate that is also known as MPEG-4 Part 10 or AVC (Advanced Video Coding).
N.O./N.C.	Normally Open/Normally Closed. The normal setting for a sensor when it is connected to a DVR. An alarm is triggered when the sensor is switched from its normal setting. For example, if a sensor for a door is set to Normally Closed, opening the door triggers an alarm.

Term	Definition
NTSC	National Television Standards Committee. The analog television standard used in most of the Americas, Japan, South Korea, Burma, Taiwan, and the Philippines.
PAL	Phase Alternating Line. Describes the color phase change in a PAL color signal. PAL is the European color encoding TV system featuring 625 lines per frame, 50 fields per second and a 4.43361875 MHz sub-carrier (4.43 MHz). Used mainly in Europe, China, Malaysia, Australia, New Zealand, the Middle East and parts of Africa.
Pan	To reposition a camera to the right or left, usually done with a computer mouse or keyboard joystick control.
Picture-in-Picture	The act of displaying one channel on the screen while a second channel is displayed in an inset window.
POS	Point Of Sale. An external device for which the SVR-1670 can retrieve text data related to recorded events. A POS transaction registers sales amounts and other information related to a purchase. When combined with a surveillance camera recording video as each transaction occurs, the data can be reviewed when the recorded video is played back.
PPPoE	Point-to-Point Protocol over Ethernet.
Preset location	The pre-positioning of pan, tilt and zoom cameras by the use of potentiometers in the moving parts of the camera head, which allow the control equipment to store and move to a set reference point when the controller dictates or when an alarm exists.
Protocol	The standard that provides the ability to control camera actions from a keyboard joystick, remote control, or user interface. The SVR-1670 supports several standard and proprietary protocols such as Samsung Techwin, Pelco D, Pelco P, Panasonic, and Samsung-E
PTZ (Pan/Tilt/Zoom)	An acronym for a camera that provides pan, tilt, and zoom capabilities.
Relay	Any device attached to a DVR that can be invoked in response to an alarm or other event. For example, a relay can lock or unlock a door in response to an alarm.
Resolution	A measure of the ability of a camera or television system to reproduce detail. Typically refers to the number of picture elements that can be reproduced with good definition.
Scheduled recording	The act of recording video based on a programmed schedule. When a DVR is set to record video based on a schedule, only video for those days and hours is recorded. Separate recording schedules can be created for each camera connected to the SVR-1670.
Seek header	The starting point for a block of data that is used by the text search function to locate the beginning of a recording or its associated data.

## Appendix G. Glossary

Term	Definition
Sensitivity	Setting sensitivity of motion detection for a camera determines how much or little movement is required before an alarm is triggered. A lower setting triggers more alarms than a higher setting.
Sensor	An alarm sensor is available for each camera channel. Sensors are normally open (N/O), or normally closed (N/C).
Spot monitor	A monitor that displays video but that does not provide access to on-screen display menus.
Sync video channel	The video camera to which recorded audio is associated.
Terminal block	A group of connectors on the rear panel of a DVR into which wires are inserted that control camera position.
Thumbnail	A scene identifier presented by the SVR-1670 after a user searches for video. Selecting a thumbnail displays the recorded video that starts with the thumbnail frame.
Tilt	To reposition a camera up or down, usually achieved with a computer mouse or keyboard joystick control.
USB	Universal Serial Bus. A standard serial bus used to connect external devices such as a flash drive or hard disk drive to the SVR-1670.
VGA	Video Graphics Array. An analog computer video standard.
Zoom	To enlarge or reduce, on a continuously variable basis, the size of a televised image primarily by varying lens focal length.

## Dimension

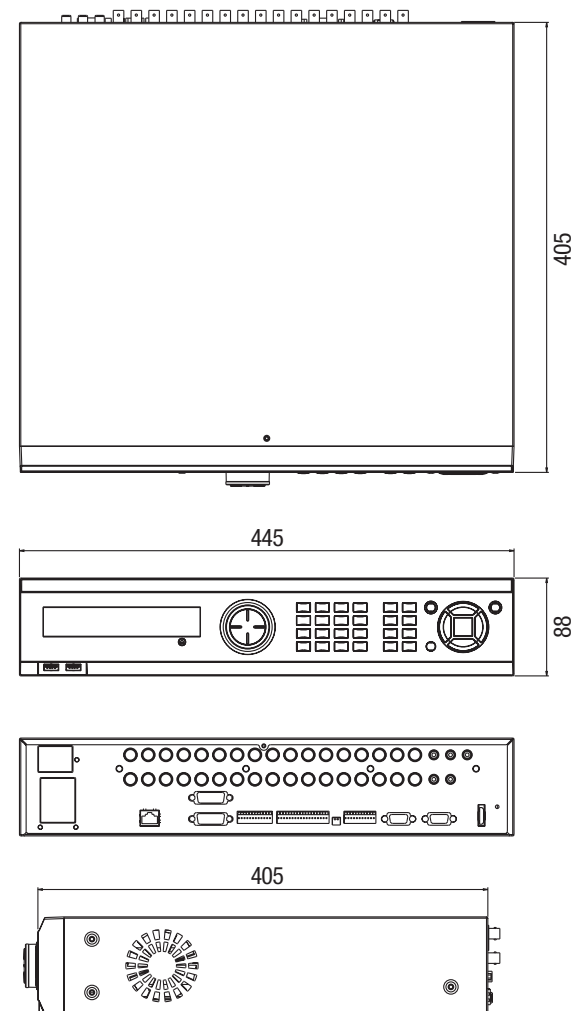

## Open Source License Report on the Product

The software included in this product contains copyrighted software that is licensed under the GPL/LGPL. You may obtain the complete Corresponding Source code from us for a period of three years after our last shipment of this product by sending email to [help.cctv@samsung.com](mailto:help.cctv@samsung.com)

If you want to obtain the complete Corresponding Source code in the physical medium such as CD-ROM, the cost of physically performing source distribution might be charged.

- GPL Software : linux kernel, busybox, cdrtools, iconv, smartctl, pppd, PPPoE, mke2fs,
- LGPL Software : glibc, libpthread, libc
- OpenSSL License : OpenSSL

## GNU GENERAL PUBLIC LICENSE

Version 2, June 1991

Copyright (C) 1989, 1991 Free Software Foundation, Inc.

51 Franklin Street, Fifth Floor, Boston, MA 02110-1301, USA

Everyone is permitted to copy and distribute verbatim copies of this license document, but changing it is not allowed.

### Preamble

The licenses for most software are designed to take away your freedom to share and change it. By contrast, the GNU General Public License is intended to guarantee your freedom to share and change free software to make sure the software is free for all its users. This General Public License applies to most of the Free Software Foundation's software and to any other program whose authors commit to using it. (Some other Free Software Foundation software is covered by the GNU Lesser General Public License instead.) You can apply it to your programs, too.

When we speak of free software, we are referring to freedom, not price. Our General Public Licenses are designed to make sure that you have the freedom to distribute copies of free software (and charge for this service if you wish), that you receive source code or can get it if you want it, that you can change the software or use pieces of it in new free programs; and that you know you can do these things.

To protect your rights, we need to make restrictions that forbid anyone to deny you these rights or to ask you to surrender the rights. These restrictions translate to certain responsibilities for you if you distribute copies of the software, or if you modify it.

For example, if you distribute copies of such a program, whether gratis or for a fee, you must give the recipients all the rights that you have. You must make sure that they, too, receive or can get the source code. And you must show them these terms so they know their rights.

We protect your rights with two steps:

(1) copyright the software, and (2) offer you this license which gives you legal permission to copy, distribute and/or modify the software.

Also, for each author's protection and ours, we want to make certain that everyone understands that there is no warranty for this free software. If the software is modified by someone else and passed on, we want its recipients to know that what they have is not the original, so that any problems introduced by others will not reflect on the original authors' reputations. Finally, any free program is threatened constantly by software patents. We wish to avoid the danger that redistributors of a free program will individually obtain patent licenses, in effect making the program proprietary. To prevent this, we have made it clear that any patent must be licensed for everyone's free use or not licensed at all. The precise terms and conditions for copying, distribution and modification follow.

## TERMS AND CONDITIONS FOR COPYING, DISTRIBUTION AND MODIFICATION

Version 2, June 1991 Copyright (C) 1989, 1991 Free Software Foundation, Inc. 51 Franklin St

0. This License applies to any program or other work which contains a notice placed by the copyright holder saying it may be distributed under the terms of this General Public License. The "Program", below, refers to any such program or work, and a "work based on the Program" means either the Program or any derivative work under copyright law: that is to say, a work containing the Program or a portion of it, either verbatim or with modifications and/or translated into another language. (Hereinafter, translation is included without limitation in the term "modification".) Each licensee is addressed as "you".

Activities other than copying, distribution and modification are not covered by this License; they are outside its scope. The act of running the Program is not restricted, and the output from the Program is covered only if its contents constitute a work based on the Program (independent of having been made by running the Program). Whether that is true depends on what the Program does.

1. You may copy and distribute verbatim copies of the Program's source code as you receive it, in any medium, provided that you conspicuously and appropriately publish on each copy an appropriate copyright notice and disclaimer of warranty; keep intact all the notices that refer to this License and to the absence of any warranty; and give any other recipients of the Program a copy of this License along with the Program.

You may charge a fee for the physical act of transferring a copy, and you may at your option offer warranty protection in exchange for a fee.

2. You may modify your copy or copies of the Program or any portion of it, thus forming a work based on the Program, and copy and

distribute such modifications or work under the terms of Section 1 above, provided that you also meet all of these conditions:

- a) You must cause the modified files to carry prominent notices stating that you changed the files and the date of any change.
- b) You must cause any work that you distribute or publish, that in whole or in part contains or is derived from the Program or any part thereof, to be licensed as a whole at no charge to all third parties under the terms of this License.
- c) If the modified program normally reads commands interactively when run, you must cause it, when started running for such interactive use in the most ordinary way, to print or display an announcement including an appropriate copyright notice and a notice that there is no warranty (or else, saying that you provide a warranty) and that users may redistribute the program under these conditions, and telling the user how to view a copy of this License. (Exception: if the Program itself is interactive but does not normally print such an announcement, your work based on the Program is not required to print an announcement.)

These requirements apply to the modified work as a whole. If identifiable sections of that work are not derived from the Program, and can be reasonably considered independent and separate works in themselves, then this License, and its terms, do not apply to those sections when you distribute them as separate works. But when you distribute the same sections as part of a whole which is a work based on the Program, the distribution of the whole must be on the terms of this License, whose permissions for other licensees extend to the entire whole, and thus to each and every part regardless of who wrote it.

Thus, it is not the intent of this section to claim rights or contest your rights to work written entirely by you; rather, the intent is to exercise the right to control the distribution of derivative or collective works based on the Program.

In addition, mere aggregation of another work not based on the Program with the Program (or with a work based on the Program) on a volume of a storage or distribution medium does not bring the other work under the scope of this License.

3. You may copy and distribute the Program (or a work based on it, under Section 2) in object code or executable form under the terms of Sections 1 and 2 above provided that you also do one of the following:
  - a) Accompany it with the complete corresponding machine-readable source code, which must be distributed under the terms of Sections 1 and 2 above on a medium customarily used for software interchange; or,
  - b) Accompany it with a written offer, valid for at least three years, to give any third party, for a charge no more than your cost of physically performing source distribution, a complete machine-readable copy of the corresponding source code, to be distributed under the terms of Sections 1 and 2 above on a medium customarily used for software interchange; or,
  - c) Accompany it with the information you received as to the offer to distribute corresponding source code. (This alternative is allowed only for noncommercial distribution and only if you received the program in object code or executable form with such an offer, in accord with Subsection b above.)

The source code for a work means the preferred form of the work for making modifications to it. For an executable work, complete source code means all the source code for all modules it contains, plus any associated interface definition files, plus the scripts used to control compilation and installation of the executable. However, as a special exception, the source code distributed need not include anything that is normally distributed (in either source or binary form) with the major components (compiler, kernel, and so on) of the operating system on which the executable runs, unless that component itself accompanies the executable.

If distribution of executable or object code is made by offering access to copy from a designated place, then offering equivalent access to copy the source code from the same place counts as distribution of the source code, even though third parties are not compelled to copy the source along with the object code.

4. You may not copy, modify, sublicense, or distribute the Program except as expressly provided under this License. Any attempt otherwise to copy, modify, sublicense or distribute the Program is void, and will automatically terminate your rights under this License. However, parties who have received copies, or rights, from you under this License will not have their licenses terminated so long as such parties remain in full compliance.
5. You are not required to accept this License, since you have not signed it. However, nothing else grants you permission to modify or distribute the Program or its derivative works. These actions are prohibited by law if you do not accept this License. Therefore, by modifying or distributing the Program (or any work based on the Program), you indicate your acceptance of this License to do so, and all its terms and conditions for copying, distributing or modifying the Program or works based on it.
6. Each time you redistribute the Program (or any work based on the Program), the recipient automatically receives a license from the original licensor to copy, distribute or modify the Program subject to these terms and conditions. You may not impose any further restrictions on the recipients' exercise of the rights granted herein. You are not responsible for enforcing compliance by third parties to this License.
7. If, as a consequence of a court judgment or allegation of patent infringement or for any other reason (not limited to patent issues), conditions are imposed on you (whether by court order, agreement or otherwise) that contradict the conditions of this License, they do not excuse you from the conditions of this License. If you cannot distribute so as to satisfy simultaneously your obligations under this License and any other pertinent obligations, then as a consequence you may not distribute the Program at all. For example, if a patent license would not permit royalty-free redistribution of the Program by all those who receive copies directly or indirectly through you, then the only way you could satisfy both it and this License would be to refrain entirely from distribution of the Program.

If any portion of this section is held invalid or unenforceable under any particular circumstance, the balance of the section is intended to apply and the section as a whole is intended to apply in other circumstances.

It is not the purpose of this section to induce you to infringe any patents or other property right claims or to contest validity of any such claims; this section has the sole purpose of protecting the integrity of the free software distribution system, which is implemented by public license practices. Many people have made generous contributions to the wide range of software distributed through that system in reliance on consistent application of that system; it is up to the author/donor to decide if he or she is willing to distribute software

through any other system and a licensee cannot impose that choice.

This section is intended to make thoroughly clear what is believed to be a consequence of the rest of this License.

8. If the distribution and/or use of the Program is restricted in certain countries either by patents or by copyrighted interfaces, the original copyright holder who places the Program under this License may add an explicit geographical distribution limitation excluding those countries, so that distribution is permitted only in or among countries not thus excluded. In such case, this License incorporates the limitation as if written in the body of this License.
9. The Free Software Foundation may publish revised and/or new versions of the General Public License from time to time. Such new versions will be similar in spirit to the present version, but may differ in detail to address new problems or concerns. Each version is given a distinguishing version number. If the Program specifies a version number of this License which applies to it and "any later version", you have the option of following the terms and conditions either of that version or of any later version published by the Free Software Foundation. If the Program does not specify a version number of this License, you may choose any version ever published by the Free Software Foundation.
10. If you wish to incorporate parts of the Program into other free programs whose distribution conditions are different, write to the author to ask for permission. For software which is copyrighted by the Free Software Foundation, write to the Free Software Foundation; we sometimes make exceptions for this. Our decision will be guided by the two goals of preserving the free status of all derivatives of our free software and of promoting the sharing and reuse of software generally.

#### NO WARRANTY

11. BECAUSE THE PROGRAM IS LICENSED FREE OF CHARGE, THERE IS NO WARRANTY FOR THE PROGRAM, TO THE EXTENT PERMITTED BY APPLICABLE LAW. EXCEPT WHEN OTHERWISE STATED IN WRITING THE COPYRIGHT HOLDERS AND/OR OTHER PARTIES PROVIDE THE PROGRAM "AS IS" WITHOUT WARRANTY OF ANY KIND, EITHER EXPRESSED OR IMPLIED, INCLUDING, BUT NOT LIMITED TO, THE IMPLIED WARRANTIES OF MERCHANTABILITY AND FITNESS FOR A PARTICULAR PURPOSE. THE ENTIRE RISK AS TO THE QUALITY AND PERFORMANCE OF THE PROGRAM IS WITH YOU. SHOULD THE PROGRAM PROVE DEFECTIVE, YOU ASSUME THE COST OF ALL NECESSARY SERVICING, REPAIR OR CORRECTION.
12. IN NO EVENT UNLESS REQUIRED BY APPLICABLE LAW OR AGREED TO IN WRITING WILL ANY COPYRIGHT HOLDER, OR ANY OTHER PARTY WHO MAY MODIFY AND/OR REDISTRIBUTE THE PROGRAM AS PERMITTED ABOVE, BE LIABLE TO YOU FOR DAMAGES, INCLUDING ANY GENERAL, SPECIAL, INCIDENTAL OR CONSEQUENTIAL DAMAGES ARISING OUT OF THE USE OR INABILITY TO USE THE PROGRAM (INCLUDING BUT NOT LIMITED TO LOSS OF DATA OR DATA BEING RENDERED INACCURATE OR LOSSES SUSTAINED BY YOU OR THIRD PARTIES OR A FAILURE OF THE PROGRAM TO OPERATE WITH ANY OTHER PROGRAMS), EVEN IF SUCH HOLDER OR OTHER PARTY HAS BEEN ADVISED OF THE POSSIBILITY OF SUCH DAMAGES.

END OF TERMS AND CONDITIONS

#### How to Apply These Terms to Your New Programs

If you develop a new program, and you want it to be of the greatest possible use to the public, the best way to achieve this is to make it free software which everyone can redistribute and change under these terms.

To do so, attach the following notices to the program. It is safest to attach them to the start of each source file to most effectively convey the exclusion of warranty; and each file should have at least the "copyright" line and a pointer to where the full notice is found.

one line to give the program's name and an idea of what it does. Copyright (C) yyyy name of author

This program is free software; you can redistribute it and/or modify it under the terms of the GNU General Public License as published by the Free Software Foundation; either version 2 of the License, or (at your option) any later version.

This program is distributed in the hope that it will be useful, but WITHOUT ANY WARRANTY; without even the implied warranty of MERCHANTABILITY or FITNESS FOR A PARTICULAR PURPOSE. See the GNU General Public License for more details.

You should have received a copy of the GNU General Public License along with this program; if not, write to the Free Software Foundation, Inc., 51 Franklin Street, Fifth Floor, Boston, MA 02110-1301, USA.

Also add information on how to contact you by electronic and paper mail. If the program is interactive, make it output a short notice like this when it starts in an interactive mode:

Gnomovision version 69, Copyright (C) year name of author Gnomovision comes with ABSOLUTELY NO WARRANTY; for details type 'show w'. This is free software, and you are welcome to redistribute it under certain conditions; type 'show c' for details.

The hypothetical commands 'show w' and 'show c' should show the appropriate parts of the General Public License. Of course, the commands you use may be called something other than 'show w' and 'show c'; they could even be mouse-clicks or menu items—whatever suits your program.

You should also get your employer (if you work as a programmer) or your school, if any, to sign a "copyright disclaimer" for the program, if necessary. Here is a sample; alter the names:

Yoyodyne, Inc., hereby disclaims all copyright interest in the program 'Gnomovision' (which makes passes at compilers) written by James Hacker.

signature of Ty Coon, 1 April 1989 Ty Coon, President of Vice This General Public License does not permit

incorporating your program into proprietary programs. If your program is a subroutine library, you may consider it more useful to permit linking proprietary applications with the library. If this is what you want to do, use the GNU Lesser General Public License instead of this License.

#### GNU LESSER GENERAL PUBLIC LICENSE

Version 3, 29 June 2007

Copyright © 2007 Free Software Foundation, Inc. <<http://fsf.org/>> Everyone is permitted to copy and distribute verbatim copies of this license document, but changing it is not allowed.

#### Preamble

The GNU General Public License is a free, copyleft

license for software and other kinds of works. The licenses for most software and other practical works are designed to take away your freedom to share and change the works. By contrast, the GNU General Public License is intended to guarantee your freedom to share and change all versions of a program—to make sure it remains free software for all its users. We, the Free Software Foundation, use the GNU General Public License for most of our software; it applies also to any other work released this way by its authors. You can apply it to your programs, too.

When we speak of free software, we are referring to freedom, not price. Our General Public Licenses are designed to make sure that you have the freedom to distribute copies of free software (and charge for them if you wish), that you receive source code or can get it if you want it, that you can change the software or use pieces of it in new free programs, and that you know you can do these things.

To protect your rights, we need to prevent others from denying you these rights or asking you to surrender the rights. Therefore, you have certain responsibilities if you distribute copies of the software, or if you modify it: responsibilities to respect the freedom of others.

For example, if you distribute copies of such a program, whether gratis or for a fee, you must pass on to the recipients the same freedoms that you received. You must make sure that they, too, receive or can get the source code. And you must show them these terms so they know their rights.

Developers that use the GNU GPL protect your rights with two steps: (1) assert copyright on the software, and (2) offer you this License giving you legal permission to copy, distribute and/or modify it.

For the developers' and authors' protection, the GPL clearly explains that there is no warranty for this free software. For both users' and authors' sake, the GPL requires that modified versions be marked as changed, so that their problems will not be attributed erroneously to authors of previous versions.

Some devices are designed to deny users access to install or run modified versions of the software inside them, although the manufacturer can do so. This is fundamentally incompatible with the aim of protecting users' freedom to change the software. The systematic pattern of such abuse occurs in the area of products for individuals to use, which is precisely where it is most unacceptable. Therefore, we have designed this version of the GPL to prohibit the practice for those products. If such problems arise substantially in other domains, we stand ready to extend this provision to those domains in future versions of the GPL, as needed to protect the freedom of users.

Finally, every program is threatened constantly by software patents. States should not allow patents to restrict development and use of software on general-purpose computers, but in those that do, we wish to avoid the special danger that patents applied to a free program could make it effectively proprietary. To prevent this, the GPL assures that patents cannot be used to render the program non-free.

The precise terms and conditions for copying, distribution and modification follow.

#### TERMS AND CONDITIONS

##### 0. Definitions.

"This License" refers to version 3 of the GNU General Public License.

"Copyright" also means copyright-like laws that apply to other kinds of works, such as semiconductor masks.

"The Program" refers to any copyrightable work licensed under this License. Each licensee is addressed as "you". "Licensees" and "recipients" may be individuals or organizations.

To "modify" a work means to copy from or adapt all or part of the work in a fashion requiring copyright permission, other than the making of an exact copy. The resulting work is called a "modified version" of the earlier work or a work "based on" the earlier work.

A "covered work" means either the unmodified Program or a work based on the Program.

To "propagate" a work means to do anything with it that, without permission, would make you directly or secondarily liable for infringement under applicable copyright law, except executing it on a computer or modifying a private copy. Propagation includes copying, distribution (with or without modification), making available to the public, and in some countries other activities as well.

To "convey" a work means any kind of propagation that enables other parties to make or receive copies. Mere interaction with a user through a computer network, with no transfer of a copy, is not conveying.

An interactive user interface displays "Appropriate Legal Notices" to the extent that it includes a convenient and prominently visible feature that (1) displays an appropriate copyright notice, and (2) tells the user that there is no warranty for the work (except to the extent that warranties are provided), that licensees may convey the work under this License, and how to view a copy of this License. If the interface presents a list of user commands or options, such as a menu, a prominent item in the list meets this criterion.

##### 1. Source Code.

The "source code" for a work means the preferred form of the work for making modifications to it. "Object code" means any non-source

form of a work.

A "Standard Interface" means an interface that either is an official standard defined by a recognized standards body, or, in the case of interfaces specified for a particular programming language, one that is widely used among developers working in that language.

The "System Libraries" of an executable work include anything, other than the work as a whole, that (a) is included in the normal form of packaging a Major Component, but which is not part of that Major Component, and (b) serves only to enable use of the work with that Major Component, or to implement a Standard Interface for which an implementation is available to the public in source code form. A "Major Component", in this context, means a major essential component (kernel, window system, and so on) of the specific operating system (if any) on which the executable work runs, or a compiler used to produce the work, or an object code interpreter used to run it.

The "Corresponding Source" for a work in object code form means all the source code needed to generate, install, and (for an executable work) run the object code and to modify the work, including scripts to control those activities. However, it does not include the work's System Libraries, or general-purpose tools or generally available free programs which are used unmodified in performing those activities but which are not part of the work. For example, Corresponding Source includes interface definition files associated with source files for the work, and the source code for shared libraries and dynamically linked subprograms that the work is specifically designed to require, such as by intimate data communication or control flow between those subprograms and other parts of the work.

The Corresponding Source need not include anything that users can regenerate automatically from other parts of the Corresponding Source.

The Corresponding Source for a work in source code form is that same work.

## 2. Basic Permissions.

All rights granted under this License are granted for the term of copyright on the Program, and are irrevocable provided the stated conditions are met. This License explicitly affirms your unlimited permission to run the unmodified Program. The output from running a covered work is covered by this License only if the output, given its content, constitutes a covered work. This License acknowledges your rights of fair use or other equivalent, as provided by copyright law.

You may make, run and propagate covered works that you do not convey, without conditions so long as your license otherwise remains in force. You may convey covered works to others for the sole purpose of having them make modifications exclusively for you, or provide you with facilities for running those works, provided that you comply with the terms of this License in conveying all material for which you do not control copyright. Those thus making or running the covered works for you must do so exclusively on your behalf, under your direction and control, on terms that prohibit them from making any copies of your copyrighted material outside their relationship with you.

Conveying under any other circumstances is permitted solely under the conditions stated below. Sublicensing is not allowed; section 10 makes it unnecessary.

## 3. Protecting Users' Legal Rights From Anti-Circumvention Law.

No covered work shall be deemed part of an effective technological measure under any applicable law fulfilling obligations under article 11 of the WIPO copyright treaty adopted on 20 December 1996, or similar laws prohibiting or restricting circumvention of such measures.

When you convey a covered work, you waive any legal power to forbid circumvention of technological measures to the extent such circumvention is effected by exercising rights under this License with respect to the covered work, and you disclaim any intention to limit operation or modification of the work as a means of enforcing, against the work's users, your or third parties' legal rights to forbid circumvention of technological measures.

## 4. Conveying Verbatim Copies.

You may convey verbatim copies of the Program's source code as you receive it, in any medium, provided that you conspicuously and appropriately publish on each copy an appropriate copyright notice; keep intact all notices stating that this License and any non-permissive terms added in accord with section 7 apply to the code; keep intact all notices of the absence of any warranty; and give all recipients a copy of this License along with the Program.

You may charge any price or no price for each copy that you convey, and you may offer support or warranty protection for a fee.

## 5. Conveying Modified Source Versions.

You may convey a work based on the Program, or the modifications to produce it from the Program, in the form of source code under the terms of section 4, provided that you also meet all of these conditions:

- The work must carry prominent notices stating that you modified it, and giving a relevant date.
- The work must carry prominent notices stating that it is released under this License and any conditions added under section 7. This requirement modifies the requirement in section 4 to "keep intact all notices".
- You must license the entire work, as a whole, under this License to anyone who comes into possession of a copy. This License will therefore apply, along with any applicable section 7 additional terms, to the whole of the work, and all its parts, regardless of how they are packaged. This License gives no permission to license the work in any other way, but it does not invalidate such permission if you have separately received it.
- If the work has interactive user interfaces, each must display Appropriate Legal Notices; however, if the Program has interactive interfaces that do not display Appropriate Legal Notices, your work need not make them do so.

A compilation of a covered work with other separate and independent works, which are not by their nature extensions of the covered work, and which are not combined with it such as to form a larger program, in or on a volume of a storage or distribution medium, is called an "aggregate" if the compilation and its resulting copyright are not used to limit the access or legal rights of the compilation's users beyond what the individual works permit. Inclusion of a covered work in an aggregate does not cause this License to apply to the

other parts of the aggregate.

## 6. Conveying Non-Source Forms.

You may convey a covered work in object code form under the terms of sections 4 and 5, provided that you also convey the machine-readable Corresponding Source under the terms of this License, in one of these ways:

- Convey the object code in, or embodied in, a physical product (including a physical distribution medium), accompanied by the Corresponding Source fixed on a durable physical medium customarily used for software interchange.
- Convey the object code in, or embodied in, a physical product (including a physical distribution medium), accompanied by a written offer, valid for at least three years and valid for as long as you offer spare parts or customer support for that product model, to give anyone who possesses the object code either (1) a copy of the Corresponding Source for all the software in the product that is covered by this License, on a durable physical medium customarily used for software interchange, for a price no more than your reasonable cost of physically performing this conveying of source, or (2) access to copy the Corresponding Source from a network server at no charge.
- Convey individual copies of the object code with a copy of the written offer to provide the corresponding Source. This alternative is allowed only occasionally and noncommercially, and only if you received the object code with such an offer, in accord with subsection 6b.
- Convey the object code by offering access from a designated place (gratis or for a charge), and offer equivalent access to the Corresponding Source in the same way through the same place at no further charge. You need not require recipients to copy the Corresponding Source along with the object code. If the place to copy the object code is a network server, the Corresponding Source may be on a different server (operated by you or a third party) that supports equivalent copying facilities, provided you maintain clear directions next to the object code saying where to find the Corresponding Source. Regardless of what server hosts the Corresponding Source, you remain obligated to ensure that it is available for as long as needed to satisfy these requirements.
- Convey the object code using peer-to-peer transmission, provided you inform other peers where the object code and Corresponding Source of the work are being offered to the general public at no charge under subsection 6d.

A separable portion of the object code, whose source code is excluded from the Corresponding Source as a System Library, need not be included in conveying the object code work.

A "User Product" is either (1) a "consumer product", which means any tangible personal property which is normally used for personal, family, or household purposes, or (2) anything designed or sold for incorporation into a dwelling. In determining whether a product is a consumer product, doubtful cases shall be resolved in favor of coverage. For a particular product received by a particular user, "normally used" refers to a typical or common use of that class of product, regardless of the status of the particular user or of the way in which the particular user actually uses, or expects or is expected to use, the product. A product is a consumer product regardless of whether the product has substantial commercial, industrial or non-consumer uses, unless such uses represent the only significant mode of use of the product.

"Installation Information" for a User Product means any methods, procedures, authorization keys, or other information required to install and execute modified versions of a covered work in that User Product from a modified version of its Corresponding Source. The information must suffice to ensure that the continued functioning of the modified object code is in no case prevented or interfered with solely because modification has been made.

If you convey an object code work under this section in, or with, or specifically for use in, a User Product, and the conveying occurs as part of a transaction in which the right of possession and use of the User Product is transferred to the recipient in perpetuity or for a fixed term (regardless of how the transaction is characterized), the Corresponding Source conveyed under this section must be accompanied by the Installation Information. But this requirement does not apply if neither you nor any third party retains the ability to install modified object code on the User Product (for example, the work has been installed in ROM).

The requirement to provide Installation Information does not include a requirement to continue to provide support service, warranty, or updates for a work that has been modified or installed by the recipient, or for the User Product in which it has been modified or installed. Access to a network may be denied when the modification itself materially and adversely affects the operation of the network or violates the rules and protocols for communication across the network.

Corresponding Source conveyed, and Installation Information provided, in accord with this section must be in a format that is publicly documented (and with an implementation available to the public in source code form), and must require no special password or key for unpacking, reading or copying.

## 7. Additional Terms.

"Additional permissions" are terms that supplement the terms of this License by making exceptions from one or more of its conditions. Additional permissions that are applicable to the entire Program shall be treated as though they were included in this License, to the extent that they are valid under applicable law. If additional permissions apply only to part of the Program, that part may be used separately under those permissions, but the entire Program remains governed by this License without regard to the additional permissions.

When you convey a copy of a covered work, you may at your option remove any additional permissions from that copy, or from any part of it. (Additional permissions may be written to require their own removal in certain cases when you modify the work.) You may place additional permissions on material, added by you to a covered work, for which you have or can give appropriate copyright permission.

Notwithstanding any other provision of this License, for material you add to a covered work, you may (if authorized by the copyright holders of that material) supplement the terms of this License with terms:

- Disclaiming warranty or limiting liability differently from the terms of sections 15 and 16 of this License; or
- Requiring preservation of specified reasonable legal notices or author attributions in that material or in the Appropriate Legal Notices



displayed by works containing it; or

- c) Prohibiting misrepresentation of the origin of that material, or requiring that modified versions of such material be marked in reasonable ways as different from the original version; or
- d) Limiting the use for publicity purposes of names of licensors or authors of the material; or
- e) Declining to grant rights under trademark law for use of some trade names, trademarks, or service marks; or
- f) Requiring indemnification of licensors and authors of that material by anyone who conveys the material (or modified versions of it) with contractual assumptions of liability to the recipient, for any liability that these contractual assumptions directly impose on those licensors and authors.

All other non-permissive additional terms are considered “further restrictions” within the meaning of section 10. If the Program as you received it, or any part of it, contains a notice stating that it is governed by this License along with a term that is a further restriction, you may remove that term. If a license document contains a further restriction but permits relicensing or conveying under this License, you may add to a covered work material governed by the terms of that license document, provided that the further restriction does not survive such relicensing or conveying.

If you add terms to a covered work in accord with this section, you must place, in the relevant source files, a statement of the additional terms that apply to those files, or a notice indicating where to find the applicable terms.

Additional terms, permissive or non-permissive, may be stated in the form of a separately written license, or stated as exceptions; the above requirements apply either way.

## 8. Termination.

You may not propagate or modify a covered work except as expressly provided under this License. Any attempt otherwise to propagate or modify it is void, and will automatically terminate your rights under this License (including any patent licenses granted under the third paragraph of section 11).

However, if you cease all violation of this License, then your license from a particular copyright holder is reinstated (a) provisionally, unless and until the copyright holder explicitly and finally terminates your license, and (b) permanently, if the copyright holder fails to notify you of the violation by some reasonable means prior to 60 days after the cessation.

Moreover, your license from a particular copyright holder is reinstated permanently if the copyright holder notifies you of the violation by some reasonable means, this is the first time you have received notice of violation of this License (for any work) from that copyright holder, and you cure the violation prior to 30 days after your receipt of the notice.

Termination of your rights under this section does not terminate the licenses of parties who have received copies or rights from you under this License. If your rights have been terminated and not permanently reinstated, you do not qualify to receive new licenses for the same material under section 10.

## 9. Acceptance Not Required for Having Copies.

You are not required to accept this License in order to receive or run a copy of the Program. Ancillary propagation of a covered work occurring solely as a consequence of using peer-to-peer transmission to receive a copy likewise does not require acceptance. However, nothing other than this License grants you permission to propagate or modify any covered work. These actions infringe copyright if you do not accept this License. Therefore, by modifying or propagating a covered work, you indicate your acceptance of this License to do so.

## 10. Automatic Licensing of Downstream Recipients.

Each time you convey a covered work, the recipient automatically receives a license from the original licensors, to run, modify and propagate that work, subject to this License. You are not responsible for enforcing compliance by third parties with this License.

An “entity transaction” is a transaction transferring control of an organization, or substantially all assets of one, or subdividing an organization, or merging organizations. If propagation of a covered work results from an entity transaction, each party to that transaction who receives a copy of the work also receives whatever licenses to the work the party’s predecessor in interest had or could give under the previous paragraph, plus a right to possession of the Corresponding Source of the work from the predecessor in interest, if the predecessor has it or can get it with reasonable efforts.

You may not impose any further restrictions on the exercise of the rights granted or affirmed under this License. For example, you may not impose a license fee, royalty, or other charge for exercise of rights granted under this License, and you may not initiate litigation (including a cross-claim or counterclaim in a lawsuit) alleging that any patent claim is infringed by making, using, selling, offering for sale, or importing the Program or any portion of it.

## 11. Patents.

A “contributor” is a copyright holder who authorizes use under this License of the Program or a work on which the Program is based. The work thus licensed is called the contributor’s “contributor version”.

A contributor’s “essential patent claims” are all patent claims owned or controlled by the contributor, whether already acquired or hereafter acquired, that would be infringed by some manner, permitted by this License, of making, using, or selling its contributor version, but do not include claims that would be infringed only as a consequence of further modification of the contributor version. For purposes of this definition, “control” includes the right to grant patent sublicenses in a manner consistent with the requirements of this License.

Each contributor grants you a non-exclusive, worldwide, royalty-free patent license under the contributor’s essential patent claims, to make, use, sell, offer for sale, import and otherwise run, modify and propagate the contents of its contributor version.

In the following three paragraphs, a “patent license” is any express agreement or commitment, however denominated, not to enforce a patent (such as an express permission to practice a patent or covenant not to sue for patent infringement). To “grant” such a patent

license to a party means to make such an agreement or commitment not to enforce a patent against the party.

If you convey a covered work, knowingly relying on a patent license, and the Corresponding Source of the work is not available for anyone to copy, free of charge and under the terms of this License, through a publicly available network server or other readily accessible means, then you must either (1) cause the Corresponding Source to be so available, or (2) arrange to deprive yourself of the benefit of the patent license for this particular work, or (3) arrange, in a manner consistent with the requirements of this License, to extend the patent license to downstream recipients. “Knowingly relying” means you have actual knowledge that, but for the patent license, your conveying the covered work in a country, or your recipient’s use of the covered work in a country, would infringe one or more identifiable patents in that country that you have reason to believe are valid.

If, pursuant to or in connection with a single transaction or arrangement, you convey, or propagate by procuring conveyance of, a covered work, and grant a patent license to some of the parties receiving the covered work authorizing them to use, propagate, modify or convey a specific copy of the covered work, then the patent license you grant is automatically extended to all recipients of the covered work and works based on it.

A patent license is “discriminatory” if it does not include within the scope of its coverage, prohibits the exercise of, or is conditioned on the non-exercise of one or more of the rights that are specifically granted under this License. You may not convey a covered work if you are a party to an arrangement with a third party that is in the business of distributing software, under which you make payment to the third party based on the extent of your activity of conveying the work, and under which the third party grants, to any of the parties who would receive the covered work from you, a discriminatory patent license

- (a) in connection with copies of the covered work conveyed by you (or copies made from those copies), or
- (b) primarily for and in connection with specific products or compilations that contain the covered work, unless you entered into that arrangement, or that patent license was granted, prior to 28 March 2007.

Nothing in this License shall be construed as excluding or limiting any implied license or other defenses to infringement that may otherwise be available to you under applicable patent law.

## 12. No Surrender of Others’ Freedom.

If conditions are imposed on you (whether by court order, agreement or otherwise) that contradict the conditions of this License, they do not excuse you from the conditions of this License. If you cannot convey a covered work so as to satisfy simultaneously your obligations under this License and any other pertinent obligations, then as a consequence you may not convey it at all. For example, if you agree to terms that obligate you to collect a royalty for further conveying from those to whom you convey the Program, the only way you could satisfy both those terms and this License would be to refrain entirely from conveying the Program.

## 13. Use with the GNU Affero General Public License.

Notwithstanding any other provision of this License, you have permission to link or combine any covered work with a work licensed under version 3 of the GNU Affero General Public License into a single combined work, and to convey the resulting work. The terms of this License will continue to apply to the part which is the covered work, but the special requirements of the GNU Affero General Public License, section 13, concerning interaction through a network will apply to the combination as such.

## 14. Revised Versions of this License.

The Free Software Foundation may publish revised and/ or new versions of the GNU General Public License from time to time. Such new versions will be similar in spirit to the present version, but may differ in detail to address new problems or concerns.

Each version is given a distinguishing version number. If the Program specifies that a certain numbered version of the GNU General Public License “or any later version” applies to it, you have the option of following the terms and conditions either of that numbered version or of any later version published by the Free Software Foundation. If the Program does not specify a version number of the GNU General Public License, you may choose any version ever published by the Free Software Foundation.

If the Program specifies that a proxy can decide which future versions of the GNU General Public License can be used, that proxy’s public statement of acceptance of a version permanently authorizes you to choose that version for the Program.

Later license versions may give you additional or different permissions. However, no additional obligations are imposed on any author or copyright holder as a result of your choosing to follow a later version.

## 15. Disclaimer of Warranty.

THERE IS NO WARRANTY FOR THE PROGRAM, TO THE EXTENT PERMITTED BY APPLICABLE LAW. EXCEPT WHEN OTHERWISE STATED IN WRITING THE COPYRIGHT HOLDERS AND/OR OTHER PARTIES PROVIDE THE PROGRAM “AS IS” WITHOUT WARRANTY OF ANY KIND, EITHER EXPRESSED OR IMPLIED, INCLUDING, BUT NOT LIMITED TO, THE IMPLIED WARRANTIES OF MERCHANTABILITY AND FITNESS FOR A PARTICULAR PURPOSE. THE ENTIRE RISK AS TO THE QUALITY AND PERFORMANCE OF THE PROGRAM IS WITH YOU. SHOULD THE PROGRAM PROVE DEFECTIVE, YOU ASSUME THE COST OF ALL NECESSARY SERVICING, REPAIR OR CORRECTION.

## 16. Limitation of Liability.

IN NO EVENT UNLESS REQUIRED BY APPLICABLE LAW OR AGREED TO IN WRITING WILL ANY COPYRIGHT HOLDER, OR ANY OTHER PARTY WHO MODIFIES AND/OR CONVEYS THE PROGRAM AS PERMITTED ABOVE, BE LIABLE TO YOU FOR DAMAGES, INCLUDING ANY GENERAL, SPECIAL, INCIDENTAL OR CONSEQUENTIAL DAMAGES ARISING OUT OF THE USE OR INABILITY TO USE THE PROGRAM (INCLUDING BUT NOT LIMITED TO LOSS OF DATA OR DATA BEING RENDERED INACCURATE OR LOSSES SUSTAINED BY YOU OR THIRD PARTIES OR A FAILURE OF THE PROGRAM TO OPERATE WITH ANY OTHER PROGRAMS), EVEN IF SUCH HOLDER OR OTHER PARTY HAS BEEN ADVISED OF THE POSSIBILITY OF SUCH DAMAGES.

## 17. Interpretation of Sections 15 and 16.

If the disclaimer of warranty and limitation of liability provided above cannot be given local legal effect according to their terms, reviewing courts shall apply local law that most closely approximates an absolute waiver of all civil liability in connection with the Program, unless a warranty or assumption of liability accompanies a copy of the Program in return for a fee.

END OF TERMS AND CONDITIONS

## GNU LESSER GENERAL PUBLIC LICENSE

Version 2.1, February 1999

Copyright (C) 1991, 1999 Free Software Foundation, Inc. 51 Franklin Street, Fifth Floor, Boston, MA 02110-1301

USA Everyone is permitted to copy and distribute verbatim copies of this license document, but changing it is not allowed.

[This is the first released version of the Lesser GPL. It also counts as the successor of the GNU Library Public License, version 2, hence the version number 2.1.]

### Preamble

The licenses for most software are designed to take away your freedom to share and change it. By contrast, the GNU General Public Licenses are intended to guarantee your freedom to share and change free software to make sure the software is free for all its users.

This license, the Lesser General Public License, applies to some specially designated software packages—typically libraries—of the Free Software Foundation and other authors who decide to use it. You can use it too, but we suggest you first think carefully about whether this license or the ordinary General Public License is the better strategy to use in any particular case, based on the explanations below.

When we speak of free software, we are referring to freedom of use, not price. Our General Public Licenses are designed to make sure that you have the freedom to distribute copies of free software (and charge for this service if you wish); that you receive source code or can get it if you want it; that you can change the software and use pieces of it in new free programs; and that you are informed that you can do these things.

To protect your rights, we need to make restrictions that forbid distributors to deny you these rights or to ask you to surrender these rights. These restrictions translate to certain responsibilities for you if you distribute copies of the library or if you modify it.

For example, if you distribute copies of the library, whether gratis or for a fee, you must give the recipients all the rights that we gave you. You must make sure that they, too, receive or can get the source code. If you link other code with the library, you must provide complete object files to the recipients, so that they can relink them with the library after making changes to the library and recompiling it. And you must show them these terms so they know their rights.

We protect your rights with a two-step method: (1) we copyright the library, and (2) we offer you this license, which gives you legal permission to copy, distribute and/or modify the library.

To protect each distributor, we want to make it very clear that there is no warranty for the free library. Also, if the library is modified by someone else and passed on, the recipients should know that what they have is not the original version, so that the original author's reputation will not be affected by problems that might be introduced by others.

Finally, software patents pose a constant threat to the existence of any free program. We wish to make sure that a company cannot effectively restrict the users of a free program by obtaining a restrictive license from a patent holder. Therefore, we insist that any patent license obtained for a version of the library must be consistent with the full freedom of use specified in this license.

Most GNU software, including some libraries, is covered by the ordinary GNU General Public License. This license, the GNU Lesser General Public License, applies to certain designated libraries, and is quite different from the ordinary General Public License. We use this license for certain libraries in order to permit linking those libraries into non-free programs.

When a program is linked with a library, whether statically or using a shared library, the combination of the two is legally speaking a combined work, a derivative of the original library. The ordinary General Public License therefore permits such linking only if the entire combination fits its criteria of freedom. The Lesser General Public License permits more lax criteria for linking other code with the library.

We call this license the "Lesser" General Public License because it does less to protect the user's freedom than the ordinary General Public License. It also provides other free software developers less of an advantage over competing non-free programs. These disadvantages are the reason we use the ordinary General Public License for many libraries. However, the Lesser license provides advantages in certain special circumstances.

For example, on rare occasions, there may be a special need to encourage the widest possible use of a certain library, so that it becomes a de-facto standard. To achieve this, non-free programs must be allowed to use the library. A more frequent case is that a free library does the same job as widely used non-free libraries. In this case, there is little to gain by limiting the free library to free software only, so we use the Lesser General Public License.

In other cases, permission to use a particular library in non-free programs enables a greater number of people to use a large body of free software. For example, permission to use the GNU C Library in non-free programs enables many more people to use the whole GNU operating system, as well as its variant, the GNU/Linux operating system.

Although the Lesser General Public License is less protective of the users' freedom, it does ensure that the user of a program that is linked with the Library has the freedom and the wherewithal to run that program using a modified version of the Library.

The precise terms and conditions for copying, distribution and modification follow. Pay close attention to the difference between a "work based on the library" and a "work that uses the library". The former contains code derived from the library, whereas the latter must be combined with the library in order to run.

## TERMS AND CONDITIONS FOR COPYING, DISTRIBUTION AND MODIFICATION

0. This License Agreement applies to any software library or other program which contains a notice placed by the copyright holder or other authorized party saying it may be distributed under the terms of this Lesser General Public License (also called "this License"). Each licensee is addressed as "you".

A "library" means a collection of software functions and/or data prepared so as to be conveniently linked with application programs (which use some of those functions and data) to form executables.

The "Library", below, refers to any such software library or work which has been distributed under these terms. A "work based on the Library" means either the Library or any derivative work under copyright law: that is to say, a work containing the Library or a portion of it, either verbatim or with modifications and/or translated straightforwardly into another language. (Hereinafter, translation is included without limitation in the term "modification".)

"Source code" for a work means the preferred form of the work for making modifications to it. For a library, complete source code means all the source code for all modules it contains, plus any associated interface definition files, plus the scripts used to control compilation and installation of the library.

Activities other than copying, distribution and modification are not covered by this License; they are outside its scope. The act of running a program using the Library is not restricted, and output from such a program is covered only if its contents constitute a work based on the Library (independent of the use of the Library in a tool for writing it). Whether that is true depends on what the Library does and what the program that uses the Library does.

1. You may copy and distribute verbatim copies of the Library's complete source code as you receive it, in any medium, provided that you conspicuously and appropriately publish on each copy an appropriate copyright notice and disclaimer of warranty; keep intact all the notices that refer to this License and to the absence of any warranty; and distribute a copy of this License along with the Library.

You may charge a fee for the physical act of transferring a copy, and you may at your option offer warranty protection in exchange for a fee.

2. You may modify your copy or copies of the Library or any portion of it, thus forming a work based on the Library, and copy and distribute such modifications or work under the terms of Section 1 above, provided that you also meet all of these conditions:

a) The modified work must itself be a software library.

b) You must cause the files modified to carry prominent notices stating that you changed the files and the date of any change.

c) You must cause the whole of the work to be licensed at no charge to all third parties under the terms of this License.

d) If a facility in the modified Library refers to a function or a table of data to be supplied by an application program that uses the facility, other than as an argument passed when the facility is invoked, then you must make a good faith effort to ensure that, in the event an application does not supply such function or table, the facility still operates, and performs whatever part of its purpose remains meaningful. (For example, a function in a library to compute square roots has a purpose that is entirely well-defined independent of the application. Therefore, Subsection 2d requires that any application-supplied function or table used by this function must be optional: if the application does not supply it, the square root function must still compute square roots.) These requirements apply to the modified work as a whole. If identifiable sections of that work are not derived from the Library, and can be reasonably considered independent and separate works in themselves, then this License, and its terms, do not apply to those sections when you distribute them as separate works. But when you distribute the same sections as part of a whole which is a work based on the Library, the distribution of the whole must be on the terms of this License, whose permissions for other licensees extend to the entire whole, and thus to each and every part regardless of who wrote it.

Thus, it is not the intent of this section to claim rights or contest your rights to work written entirely by you; rather, the intent is to exercise the right to control the distribution of derivative or collective works based on the Library.

In addition, mere aggregation of another work not based on the Library with the Library (or with a work based on the Library) on a volume of a storage or distribution medium does not bring the other work under the scope of this License.

3. You may opt to apply the terms of the ordinary GNU General Public License instead of this License to a given copy of the Library. To do this, you must alter all the notices that refer to this License, so that they refer to the ordinary GNU General Public License, version 2, instead of to this License. (If a newer version than version 2 of the ordinary GNU General Public License has appeared, then you can specify that version instead if you wish.) Do not make any other change in these notices.

Once this change is made in a given copy, it is irreversible for that copy, so the ordinary GNU General Public License applies to all subsequent copies and derivative works made from that copy.

This option is useful when you wish to copy part of the code of the Library into a program that is not a library.

4. You may copy and distribute the Library (or a portion or derivative of it, under Section 2) in object code or executable form under the terms of Sections 1 and 2 above provided that you accompany it with the complete corresponding machine-readable source code, which must be distributed under the terms of Sections 1 and 2 above on a medium customarily used for software interchange.

If distribution of object code is made by offering access to copy from a designated place, then offering equivalent access to copy the source code from the same place satisfies the requirement to distribute the source code, even though third parties are not compelled to copy the source along with the object code.

5. A program that contains no derivative of any portion of the Library, but is designed to work with the Library by being compiled or linked with it, is called a "work that uses the Library". Such a work, in isolation, is not a derivative work of the Library, and therefore falls outside the scope of this License.

However, linking a "work that uses the Library" with the Library creates an executable that is a derivative of the Library (because it

contains portions of the Library), rather than a “work that uses the library”. The executable is therefore covered by this License. Section 6 states terms for distribution of such executables.

When a “work that uses the Library” uses material from a header file that is part of the Library, the object code for the work may be a derivative work of the Library even though the source code is not. Whether this is true is especially significant if the work can be linked without the Library, or if the work is itself a library. The threshold for this to be true is not precisely defined by law.

If such an object file uses only numerical parameters, data structure layouts and accessors, and small macros and small inline functions (ten lines or less in length), then the use of the object file is unrestricted, regardless of whether it is legally a derivative work. (Executables containing this object code plus portions of the Library will still fall under Section 6.)

Otherwise, if the work is a derivative of the Library, you may distribute the object code for the work under the terms of Section 6. Any executables containing that work also fall under Section 6, whether or not they are linked directly with the Library itself.

6. As an exception to the Sections above, you may also combine or link a “work that uses the Library” with the Library to produce a work containing portions of the Library, and distribute that work under terms of your choice, provided that the terms permit modification of the work for the customer’s own use and reverse engineering for debugging such modifications.

You must give prominent notice with each copy of the work that the Library is used in it and that the Library and its use are covered by this License. You must supply a copy of this License. If the work during execution displays copyright notices, you must include the copyright notice for the Library among them, as well as a reference directing the user to the copy of this License. Also, you must do one of these things:

- a) Accompany the work with the complete corresponding machine-readable source code for the Library including whatever changes were used in the work (which must be distributed under Sections 1 and 2 above); and, if the work is an executable linked with the Library, with the complete machine readable “work that uses the Library”, as object code and/or source code, so that the user can modify the Library and then relink to produce a modified executable containing the modified Library. (It is understood that the user who changes the contents of definitions files in the Library will not necessarily be able to recompile the application to use the modified definitions.)
- b) Use a suitable shared library mechanism for linking with the Library. A suitable mechanism is one that (1) uses at run time a copy of the library already present on the user’s computer system, rather than copying library functions into the executable, and (2) will operate properly with a modified version of the library, if the user installs one, as long as the modified version is interface-compatible with the version that the work was made with.
- c) Accompany the work with a written offer, valid for at least three years, to give the same user the materials specified in Subsection 6a, above, for a charge no more than the cost of performing this distribution.
- d) If distribution of the work is made by offering access to copy from a designated place, offer equivalent access to copy the above specified materials from the same place.
- e) Verify that the user has already received a copy of these materials or that you have already sent this user a copy.

For an executable, the required form of the “work that uses the Library” must include any data and utility programs needed for reproducing the executable from it. However, as a special exception, the materials to be distributed need not include anything that is normally distributed (in either source or binary form) with the major components (compiler, kernel, and so on) of the operating system on which the executable runs, unless that component itself accompanies the executable.

It may happen that this requirement contradicts the license restrictions of other proprietary libraries that do not normally accompany the operating system. Such a contradiction means you cannot use both them and the Library together in an executable that you distribute.

7. You may place library facilities that are a work based on the Library side-by-side in a single library together with other library facilities not covered by this License, and distribute such a combined library, provided that the separate distribution of the work based on the Library and of the other library facilities is otherwise permitted, and provided that you do these two things:

- a) Accompany the combined library with a copy of the same work based on the Library, uncombined with any other library facilities. This must be distributed under the terms of the Sections above.
- b) Give prominent notice with the combined library of the fact that part of it is a work based on the Library, and explaining where to find the accompanying uncombined form of the same work.

8. You may not copy, modify, sublicense, link with, or distribute the Library except as expressly provided under this License. Any attempt otherwise to copy, modify, sublicense, link with, or distribute the Library is void, and will automatically terminate your rights under this License. However, parties who have received copies, or rights, from you under this License will not have their licenses terminated so long as such parties remain in full compliance.
9. You are not required to accept this License, since you have not signed it. However, nothing else grants you permission to modify or distribute the Library or its derivative works. These actions are prohibited by law if you do not accept this License. Therefore, by modifying or distributing the Library (or any work based on the Library), you indicate your acceptance of this License to do so, and all its terms and conditions for copying, distributing or modifying the Library or works based on it.
10. Each time you redistribute the Library (or any work based on the Library), the recipient automatically receives a license from the original licensor to copy, distribute, link with or modify the Library subject to these terms and conditions. You may not impose any further restrictions on the recipients’ exercise of the rights granted herein. You are not responsible for enforcing compliance by third parties with this License.
11. If, as a consequence of a court judgment or allegation of patent infringement or for any other reason (not limited to patent issues), conditions are imposed on you (whether by court order, agreement or otherwise) that contradict the conditions of this License, they do

not excuse you from the conditions of this License. If you cannot distribute so as to satisfy simultaneously your obligations under this License and any other pertinent obligations, then as a consequence you may not distribute the Library at all. For example, if a patent license would not permit royalty free redistribution of the Library by all those who receive copies directly or indirectly through you, then the only way you could satisfy both it and this License would be to refrain entirely from distribution of the Library.

If any portion of this section is held invalid or unenforceable under any particular circumstance, the balance of the section is intended to apply, and the section as a whole is intended to apply in other circumstances.

It is not the purpose of this section to induce you to infringe any patents or other property right claims or to contest validity of any such claims; this section has the sole purpose of protecting the integrity of the free software distribution system which is implemented by public license practices. Many people have made generous contributions to the wide range of software distributed through that system in reliance on consistent application of that system; it is up to the author/donor to decide if he or she is willing to distribute software through any other system and a licensee cannot impose that choice.

This section is intended to make thoroughly clear what is believed to be a consequence of the rest of this License.

12. If the distribution and/or use of the Library is restricted in certain countries either by patents or by copyrighted interfaces, the original copyright holder who places the Library under this License may add an explicit geographical distribution limitation excluding those countries, so that distribution is permitted only in or among countries not thus excluded. In such case, this License incorporates the limitation as if written in the body of this License.
13. The Free Software Foundation may publish revised and/or new versions of the Lesser General Public License from time to time. Such new versions will be similar in spirit to the present version, but may differ in detail to address new problems or concerns. Each version is given a distinguishing version number. If the Library specifies a version number of this License which applies to it and “any later version”, you have the option of following the terms and conditions either of that version or of any later version published by the Free Software Foundation. If the Library does not specify a license version number, you may choose any version ever published by the Free Software Foundation.
14. If you wish to incorporate parts of the Library into other free programs whose distribution conditions are incompatible with these, write to the author to ask for permission. For software which is copyrighted by the Free Software Foundation, write to the Free Software Foundation; we sometimes make exceptions for this. Our decision will be guided by the two goals of preserving the free status of all derivatives of our free software and of promoting the sharing and reuse of software generally.

## NO WARRANTY

15. BECAUSE THE LIBRARY IS LICENSED FREE OF CHARGE, THERE IS NO WARRANTY FOR THE LIBRARY, TO THE EXTENT PERMITTED BY APPLICABLE LAW. EXCEPT WHEN OTHERWISE STATED IN WRITING THE COPYRIGHT HOLDERS AND/OR OTHER PARTIES PROVIDE THE LIBRARY “AS IS” WITHOUT WARRANTY OF ANY KIND, EITHER EXPRESSED OR IMPLIED, INCLUDING, BUT NOT LIMITED TO, THE IMPLIED WARRANTIES OF MERCHANTABILITY AND FITNESS FOR A PARTICULAR PURPOSE. THE ENTIRE RISK AS TO THE QUALITY AND PERFORMANCE OF THE LIBRARY IS WITH YOU. SHOULD THE LIBRARY PROVE DEFECTIVE, YOU ASSUME THE COST OF ALL NECESSARY SERVICING, REPAIR OR CORRECTION.
16. IN NO EVENT UNLESS REQUIRED BY APPLICABLE LAW OR AGREED TO IN WRITING WILL ANY COPYRIGHT HOLDER, OR ANY OTHER PARTY WHO MAY MODIFY AND/OR REDISTRIBUTE THE LIBRARY AS PERMITTED ABOVE, BE LIABLE TO YOU FOR DAMAGES, INCLUDING ANY GENERAL, SPECIAL, INCIDENTAL OR CONSEQUENTIAL DAMAGES ARISING OUT OF THE USE OR INABILITY TO USE THE LIBRARY (INCLUDING BUT NOT LIMITED TO LOSS OF DATA OR DATA BEING RENDERED INACCURATE OR LOSSES SUSTAINED BY YOU OR THIRD PARTIES OR A FAILURE OF THE LIBRARY TO OPERATE WITH ANY OTHER SOFTWARE), EVEN IF SUCH HOLDER OR OTHER PARTY HAS BEEN ADVISED OF THE POSSIBILITY OF SUCH DAMAGES.

END OF TERMS AND CONDITIONS

## How to Apply These Terms to Your New Libraries

If you develop a new library, and you want it to be of the greatest possible use to the public, we recommend making it free software that everyone can redistribute and change. You can do so by permitting redistribution under these terms (or, alternatively, under the terms of the ordinary General Public License).

To apply these terms, attach the following notices to the library. It is safest to attach them to the start of each source file to most effectively convey the exclusion of warranty; and each file should have at least the “copyright” line and a pointer to where the full notice is found. one line to give the library’s name and an idea of what it does.

Copyright (C) year name of author

This library is free software; you can redistribute it and/ or modify it under the terms of the GNU Lesser General Public License as published by the Free Software Foundation; either version 2.1 of the License, or (at your option) any later version.

This library is distributed in the hope that it will be useful, but WITHOUT ANY WARRANTY; without even the implied warranty of MERCHANTABILITY or FITNESS FOR A PARTICULAR PURPOSE. See the GNU Lesser General Public License for more details.

You should have received a copy of the GNU Lesser General Public License along with this library; if not, write to the Free Software Foundation, Inc., 51 Franklin Street, Fifth Floor, Boston, MA 02110-1301 USA Also add information on how to contact you by electronic and paper mail.

You should also get your employer (if you work as a programmer) or your school, if any, to sign a “copyright disclaimer” for the library, if necessary. Here is a sample; alter the names:

Yoyodyne, Inc., hereby disclaims all copyright interest in the library 'Frob' (a library for tweaking knobs) written by James Random Hacker. signature of Ty Coon, 1 April 1990 Ty Coon, President of Vice.

#### OpenSSL LICENSE

Copyright (c) 1998-2006 The OpenSSL Project. All rights reserved. Redistribution and use in source and binary forms, with or without modification, are permitted provided that the following conditions are met:

1. Redistributions of source code must retain the above copyright notice, this list of conditions and the following disclaimer.
2. Redistributions in binary form must reproduce the above copyright notice, this list of conditions and the following disclaimer in the documentation and/or other materials provided with the distribution.
3. All advertising materials mentioning features or use of this software must display the following acknowledgment: "This product includes software developed by the OpenSSL Project for use in the OpenSSL Toolkit. (<http://www.openssl.org/>)"
4. The names "OpenSSL Toolkit" and "OpenSSL Project" must not be used to endorse or promote products derived from this software without prior written permission. For written permission, please contact [openssl-core@openssl.org](mailto:openssl-core@openssl.org).
5. Products derived from this software may not be called "OpenSSL" nor may "OpenSSL" appear in their names without prior written permission of the OpenSSL Project.
6. Redistributions of any form whatsoever must retain the following acknowledgment: "This product includes software developed by the OpenSSL Project for use in the OpenSSL Toolkit (<http://www.openssl.org/>)"

THIS SOFTWARE IS PROVIDED BY THE OpenSSL PROJECT "AS IS" AND ANY EXPRESSED OR IMPLIED WARRANTIES, INCLUDING, BUT NOT LIMITED TO, THE IMPLIED WARRANTIES OF MERCHANTABILITY AND FITNESS FOR A PARTICULAR PURPOSE ARE DISCLAIMED. IN NO EVENT SHALL THE OpenSSL PROJECT OR ITS CONTRIBUTORS BE LIABLE FOR ANY DIRECT, INDIRECT, INCIDENTAL, SPECIAL, EXEMPLARY, OR CONSEQUENTIAL DAMAGES (INCLUDING, BUT NOT LIMITED TO, PROCUREMENT OF SUBSTITUTE GOODS OR SERVICES; LOSS OF USE, DATA, OR PROFITS; OR BUSINESS INTERRUPTION) HOWEVER CAUSED AND ON ANY THEORY OF LIABILITY, WHETHER IN CONTRACT, STRICT LIABILITY, OR TORT (INCLUDING NEGLIGENCE OR OTHERWISE) ARISING IN ANY WAY OUT OF THE USE OF THIS SOFTWARE, EVEN IF ADVISED OF THE POSSIBILITY OF SUCH DAMAGE. This product includes cryptographic software written by Eric Young ([ey@cryptsoft.com](mailto:ey@cryptsoft.com)). This product includes software written by Tim Hudson ([tjh@cryptsoft.com](mailto:tjh@cryptsoft.com)).

#### Original SSLey License

Copyright (C) 1995-1998 Eric Young ([ey@cryptsoft.com](mailto:ey@cryptsoft.com)) All rights reserved. This package is an SSL implementation written by Eric Young ([ey@cryptsoft.com](mailto:ey@cryptsoft.com)). The implementation was written so as to conform with Netscapes SSL. This library is free for commercial and non-commercial use as long as the following conditions are aheared to. The following conditions apply to all code found in this distribution, be it the RC4, RSA, lhash, DES, etc., code; not just the SSL code. The SSL documentation included with this distribution is covered by the same copyright terms except that the holder is Tim Hudson ([tjh@cryptsoft.com](mailto:tjh@cryptsoft.com)).

Copyright remains Eric Young's, and as such any Copyright notices in the code are not to be removed. If this package is used in a product, Eric Young should be given attribution as the author of the parts of the library used. This can be in the form of a textual message at program startup or in documentation (online or textual) provided with the package. Redistribution and use in source and binary forms, with or without modification, are permitted provided that the following conditions are met:

1. Redistributions of source code must retain the copyright notice, this list of conditions and the following disclaimer.
2. Redistributions in binary form must reproduce the above copyright notice, this list of conditions and the following disclaimer in the documentation and/or other materials provided with the distribution.
3. All advertising materials mentioning features or use of this software must display the following acknowledgement: "This product includes cryptographic software written by Eric Young ([ey@cryptsoft.com](mailto:ey@cryptsoft.com))" The word 'cryptographic' can be left out if the routines from the library being used are not cryptographic related :-).
4. If you include any Windows specific code (or a derivative thereof) from the apps directory (application code) you must include an acknowledgement: "This product includes software written by Tim Hudson ([tjh@cryptsoft.com](mailto:tjh@cryptsoft.com))"

THIS SOFTWARE IS PROVIDED BY ERIC YOUNG "AS IS" AND ANY EXPRESS OR IMPLIED WARRANTIES, INCLUDING, BUT NOT LIMITED TO, THE IMPLIED WARRANTIES OF MERCHANTABILITY AND FITNESS FOR A PARTICULAR PURPOSE ARE DISCLAIMED. IN NO EVENT SHALL THE AUTHOR OR CONTRIBUTORS BE LIABLE FOR ANY DIRECT, INDIRECT, INCIDENTAL, SPECIAL, EXEMPLARY, OR CONSEQUENTIAL DAMAGES (INCLUDING, BUT NOT LIMITED TO, PROCUREMENT OF SUBSTITUTE GOODS OR SERVICES; LOSS OF USE, DATA, OR PROFITS; OR BUSINESS INTERRUPTION) HOWEVER CAUSED AND ON ANY THEORY OF LIABILITY, WHETHER IN CONTRACT, STRICT LIABILITY, OR TORT (INCLUDING NEGLIGENCE OR OTHERWISE) ARISING IN ANY WAY OUT OF THE USE OF THIS SOFTWARE, EVEN IF ADVISED OF THE POSSIBILITY OF SUCH DAMAGE.

The licence and distribution terms for any publically available version or derivative of this code cannot be changed. i.e. this code cannot simply be copied and put under another distribution licence [including the GNU Public Licence.

## Declaration on of Conformity



**Type of equipment:** Digital Video Recorder  
**Brand Name /Trade Mark:** SAMSUNG  
**Type designation /model:** SVR-1670  
**Manufacturer:** SAMSUNG TECHWIN CO., LTD.

#### In accordance with the following Directives:

2004/108/EC The Electromagnetic Compatibility Directive  
Including amendments by the CE Marking Directive 93/68/EEC

#### The following harmonized European standards and technical specifications have been applied:

EN 55022:2006	Limits and methods of measurement of radio disturbance characteristics of information technology equipment
EN 61000-3-3:1995 +A1:2001 +A2:2005	Limitation of voltage changes, voltage fluctuations and flicker in public low-voltage supply systems, for equipment with rated current $\leq$ 16 A per phase and not subject to conditional connection Product family standard: Immunity requirements for components of fire, intruder and social alarm systems Electrostatic discharge immunity test
EN 50130-4:1995 +A1:1998 +A2 :2003	
EN 61000-4-2:1995 +A1:1998 +A2:2001	Radiated, radio-frequency, electromagnetic field immunity test
EN 61000-4-3:2006	Electrical fast transient/burst immunity test
EN 61000-4-4:2004	Surge immunity test
EN 61000-4-5:2006	Immunity to conducted disturbances, induced by radio-frequency fields
EN 61000-4-6:2007	Voltage dips, short interruptions and voltage variations immunity tests
EN 61000-4-11:2004	

The CE Marking on the products and/or their packaging signifies that SAMSUNG TECHWIN CO.,LTD. holds the reference technical file available to the European Union authorities.

**Place and date of issue:** #145-3, Sangdaewon 1-Dong, Jungwon-Gu, Sungnam-Shi, Kyonggi-Do, Korea / October 9, 2009

**Authorized Signatory:** Name : Young Soon, Choi

Title : Principal Research Engineer

Signature :

Chang Suk Oh  
SAMSUNG TECHWIN CO., LTD

# SAMSUNG TECHWIN

The Samsung logo, consisting of the word "SAMSUNG" in white, uppercase letters inside a black, horizontally-oriented oval.

## SALES NETWORK

---

### · SAMSUNG TECHWIN CO., LTD.

Samsungtechwin R&D Center, 701, Sampyeong-dong, Bundang-gu, Seongnam-si, Gyeonggi-do, Korea, 463-400  
TEL : +82-70-7147-8740-60 , FAX : +82-31-8018-3745

### · SAMSUNG TECHWIN AMERICA Inc.

1480 Charles Willard St, Carson, CA 90746, UNITED STATES  
Tol Free: +1-877-213-1222, FAX: +1-310-632-2195  
[www.samsungcctvusa.com](http://www.samsungcctvusa.com)

### · SAMSUNG TECHWIN EUROPE LTD.

Samsung House, 1000 Hillswood Drive, Hillswood Business  
Park Chertsey, Surrey, UNITED KINGDOM KT16 0PS  
TEL: +44-1932-45-5300, FAX: +44-1932-45-5325

---

[www.samsungtechwin.com](http://www.samsungtechwin.com)  
[www.samsungsecurity.com](http://www.samsungsecurity.com)  
[www.samsungipolis.com](http://www.samsungipolis.com)

P/No. : Z6806-1079-01C