

**SAMSUNG TECHWIN**



**SALES NETWORK**

**• SAMSUNG TECHWIN CO., LTD.**

145-3, Sangdaewon 1-dong, Jungwon-gu, Seongnam-si,  
Gyeonggi-do 462-703, Korea  
TEL : +82-31-740-8137-8139 FAX : +82-31-740-8145

**• SAMSUNG OPTO-ELECTRONICS UK, LTD.**

Samsung House, 1000 Hillswood Drive, Hillswood Business  
Park Chertsey, Surrey KT16 OPS  
TEL : +44-1932-45-5308 FAX : +44-1932-45-5325

[www.samsungtechwin.com](http://www.samsungtechwin.com)  
[www.samsungcctv.com](http://www.samsungcctv.com)

**• TIANJIN SAMSUNG OPTO-ELECTRONICS CO., LTD.**

7 Pingchang Rd, Nankai Dist. Tianjin 300190, P.R China  
TEL : +86-22-2761-4724(33821) FAX : +86-22-2761-6514

P/No. : Z6806-0737-01A  
VAN 06. 06



**30X** Crisp Image Detection



**PTZ Dome Camera SPD-3000/2300 User's Manual**

Thank you for purchasing a SAMSUNG CCD CAMERA.  
Before attempting to connect or operate this product,  
please read these instructions carefully and save this manual for future use.

**ENGLISH**

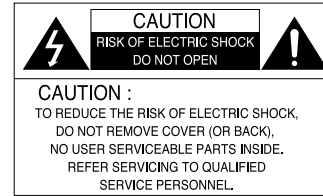

The lightning flash with an arrowhead symbol, within an equilateral triangle is intended to alert the user to the presence of uninsulated “dangerous voltage” within the product’s enclosure that may be of sufficient magnitude to constitute a risk of electric shock to persons.



The exclamation point within an equilateral triangle is intended to alert the user to the presence of important operating and maintenance (servicing) instructions in the literature accompanying the appliance.

**INFORMATION** - This equipment has been tested and found to comply with limits for a Class A digital device, pursuant to part 15 of the FCC Rules. These limits are designed to provide reasonable protection against harmful interference when the equipment is operated in a commercial environment. This equipment generates, uses, and can radiate radio frequency energy and, if not installed and used in accordance with the instruction manual, may cause harmful interference to radio communications.

Operation of this equipment in a residential area is likely to cause harmful interference in which case the user will be required to correct the interference at his own expense.

**WARNING** - Changes or modifications not expressly approved by the manufacturer could void the user’s authority to operate the equipment.

**CAUTION** : To prevent electric shock and risk of fire hazards:

- ◆ Do NOT use power sources other than that specified.
- ◆ Do NOT expose this appliance to rain or moisture.

This installation should be made by a qualified service person and should conform to all local codes.

## Features



### 30X/23X Zoom Lens with Auto-Focus Function

The 30X/23X zoom lens having Auto-focus function magnifies the image up to 300/230 times when used with the digital 10X zoom function.

### Various Auto Surveillances

#### \*Individual Preset Saving Modes

13 camera adjustment functions can be saved independently in each Preset menu to provide optimum images.

#### \*Various Protocols

Five different makers protocols are supported: Samsung Techwin, Pelco, Samsung Electronics, Panasonic and Vicon.

#### \*PTZ Tracking

4 patterns operated with the joystick can be saved and replayed by users.

#### \*AUTO Swing

Pan or Tilt is operated in sequence between 2 designated positions.

#### \*Group Search

Maximum 128 Preset positions are toured in order.

#### \*Tour Search

Maximum 6 Group Search functions are toured in order.

### Smart P/T

Even when the Zoom-In function is On for the Pan and Tilt speed correction function linked to the zoom position, fine manual operation is possible.

### Day & Night

Day & Night function of ICR (IR Cut-Filter Removal) and Sens-Up function can achieve optimum images during day and night.

\*Sens-Up function improves the CCD sensitivity by lengthening the exposure time using electricity.

\*Day&Night function enables users to select and adjust the colour and black and white images according to the light level.

### OSD (On Screen Display)

Items such as Camera ID, Camera Name, Preset Number, Preset Name, Area Name and Camera Status are displayed on the monitor. Camera functions can be set up on the OSD menu screen.

### 128 Preset Positions

A maximum of 128 Preset positions can be set up. This function enables users to set up the monitoring place any time.

### Digital Flip

When you want to monitor the moving object below the camera, you can execute the Digital Flip using the controller's joystick. The moving object can be monitored without screen reverse.

### Area Masking

For privacy protection, a maximum of 8 areas can be masked among the surveillance areas preventing them to be displayed on the screen.



Samsung Techwin cares for the environment at all product manufacturing stages to preserve the environment, and is taking a number of steps to provide customers with more environment-friendly products. The Eco mark represents Samsung Techwin's will to create environment-friendly products, and indicates that the product satisfies the EU RoHS Directive.

## Warnings & Cautions

This information is provided to ensure your safety and to prevent any losses, financial or otherwise. Please read it carefully and use the product accordingly.

### Warning/Attention/Special Mark Messages



Ignoring this information may result in material loss and/or serious personal injuries including death.



Indicates "Never Allowed."



Indicates "No Disassembling."



Indicates "Must Observe."



### Correct Disposal of This Product (Waste Electrical & Electronic Equipment)

(Applicable in the European Union and other European countries with separate collection systems)

This marking shown on the product or its literature, indicates that it should not be disposed with other household wastes at the end of its working life. To prevent possible harm to the environment or human health from uncontrolled waste disposal, please separate this from other types of wastes and recycle it responsibly to promote the sustainable reuse of material resources.

Household users should contact either the retailer where they purchased this product, or their local government office, for details of where and how they can take this item for environmentally safe recycling.

Business users should contact their supplier and check the terms and conditions of the purchase contract. This product should not be mixed with other commercial wastes for disposal.

# Contents

<b>Precautions</b> .....	8	<b>Functional Description</b> .....	30
<b>Part Names and Functions</b> .....	10	■ OSD Menu Organization .....	30
■ Body .....	10	■ Dome Camera User Menu Settings .....	34
■ Camera Holder .....	11	1. Camera Settings .....	34
■ Camera Holder Connection .....	12	2. Sequence Setting .....	42
■ Camera Holder Initial Setting .....	13	3. P/T Setting .....	48
<b>Components and Accessories</b> .....	22	4. OSD Setting .....	51
<b>Installation</b> .....	23	5. Alarm Setting .....	54
		6. Initialization Setting .....	56
		7. Status .....	57
		<b>Product Structure and Installation</b> .....	58
		<b>Specifications</b> .....	62

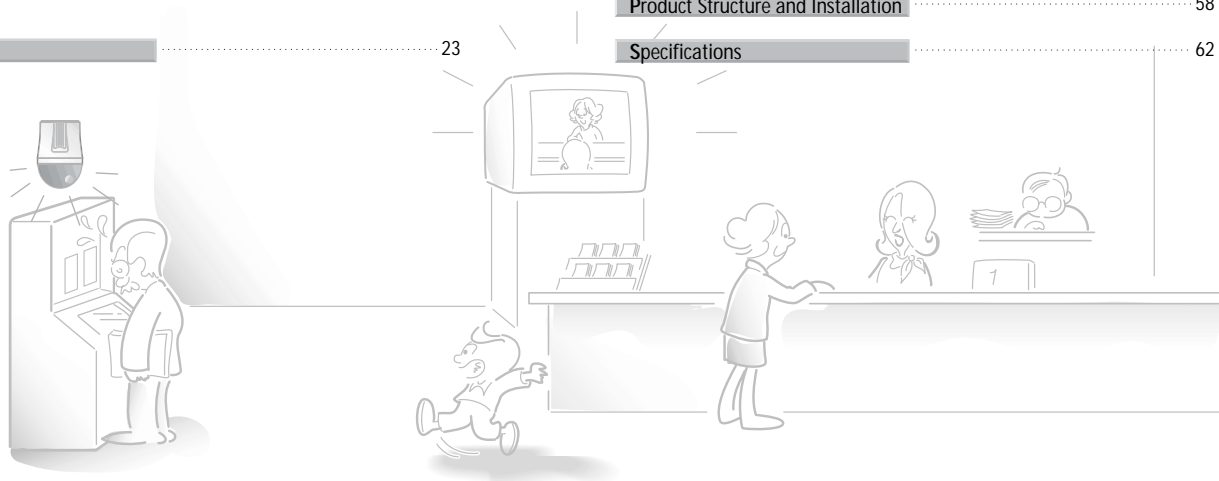

## Precautions

**Installation by unqualified persons is not recommended.**



Experienced and skilled technicians have to install this product. Unqualified and personal installation may cause fire or electric shock. Contact the dealer for installation.

**If any unusual odors or smoke comes from the camera, stop using the product.**



It may cause fire.

**Do not install the product in too hot or too cold environments.**



Do not use the camera under extreme temperatures (below  $-10^{\circ}$  or above  $+50^{\circ}$ ). It may cause poor image quality or failure. Be especially careful to provide ventilation when operating the camera under high temperatures.

**Do not install the camera in intermittent lighting environments.**



Do not install the camera under severely changing lighting environments such as fluorescent lamps. It may cause the camera to work improperly.

**Do not install the product under humid conditions or near flammable or explosive gases.**



It may cause failure, electric shock or fire.

**Install the product in a place strong enough to hold it.**

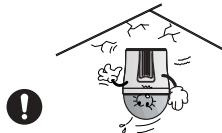

The product may fall.

**Never drop the camera or subject it to severe shocks or vibrations.**



It may cause failure.

**Do not aim the camera at the sun or any other strong light source.**

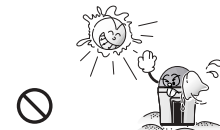

It may cause fatal damage to CCD device or internal circuit.

**Do not handle the power plug with wet hands.**

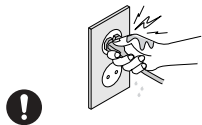

It may cause electric shock.

**Do not disassemble or insert foreign objects.**



It may cause failure or electric shock.

**Do not touch the front glass of the camera.**



It is the most important part of camera. Be careful not to mark it with fingerprints.

**Do not install the camera where it might be exposed to rain, water or spillages.**



If the camera gets wet, it may cause failure.

## Part Names and Functions

### Body

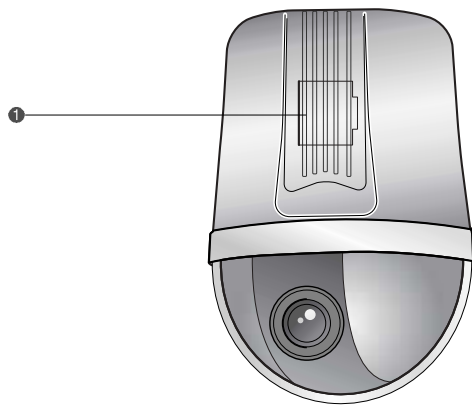

- ❶ **Power Switch**  
Power ON/OFF (Factory Setting: OFF)

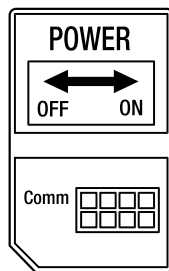

<Figure: Door Part Label>

### Camera Holder

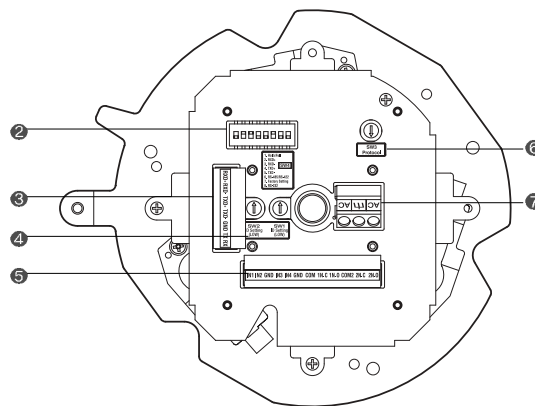

- ❷ **Function Setup Switch**  
1. Half/Full 2.3.4.5. RS-485/422 Terminal Setting  
6. RS-485/422 Communication 7. Factory setting 8. RS-232
- ❸ **Controller Connection Input**  
1. RXD+ 2. RXD- 3. TXD+ 4. TXD- 5. GND 6. TX 7. RX
- ❹ **ID Setup Switch**
- ❺ **Alarm Connection Input**  
1. IN1 2. IN2 3. GND 4. IN3 5. IN4 6. GND  
7. COM1 8. 1N.C 9. 1N.O 10. COM2 11. 2N.C 12. 2N.O
- ❻ **Protocol Selection Switch**
- ❼ **AC 24V Input**

# Part Names and Functions

## Camera Holder Connection

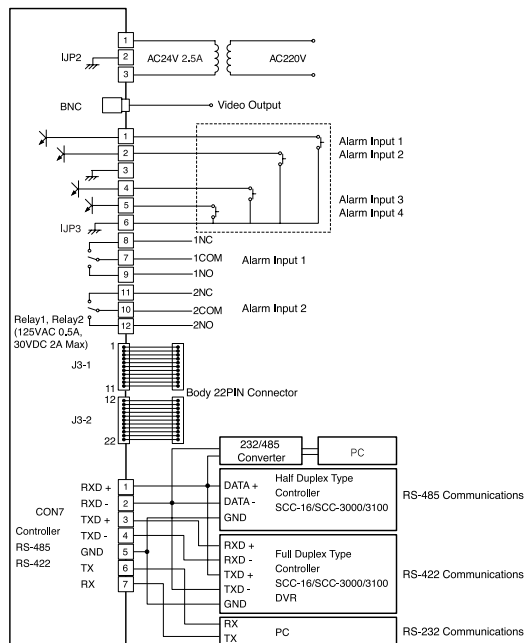

### Notes

- In order to control the speed dome camera by personal computer, exclusive program should be used.

## Camera Holder Initial Settings

### Setting Communications Protocol

Use the SW3 of installation bracket to set the communications protocol.

SW1	Protocol	Baud Rate(BPS)
0	Samsung	9,600
1	Samsung	19,200
2	Pelco-D	2,400
3	Pelco-D	4,800
4	Pelco-D	9,600
5	Samsung Elec.	9,600
6	Samsung Elec.	19,200
7	Samsung Elec.	38,400
8	Panasonic	9,600
9	Panasonic	19,200
10	Vicon	4,800
11	Vicon	9,600
12-F	Reserve	



### Notes

- If the speed dome camera is controlled by the Panasonic and Vicon controller, please contact with our company custom satisfaction part and technical part.

## Part Names and Functions

### Setting Baud Rate Based on DVR Model (Camera Holder)

If the speed dome camera is controlled not by the camera controller but by a DVR, set the communication speed based on the DVR model as follows.

Protocol DVR Model	Samsung	Pelco	Samsung Elec.
SVR-430	9600,19200	9600	19,200,38,400
SVR-440	9600,19200	4800, 9600	19,200,38,400
SVR-1630	9600,19200	2400,4800,9600	19,200,38,400
SVR-1650	9600,19200	2400,4800,9600	19,200,38400

#### Notes

- Depending on the DVR firmware version, the Control function may not be supported. Use this function after installation of the final version.

### Setting Camera ID (Camera Holder)

Set the Camera ID using 2 rotary switches (SW1 and SW2).

SW1 is the upper level switch and SW2 is the lower level switch.

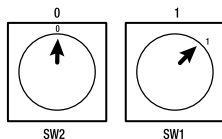
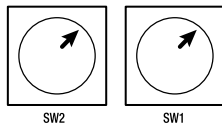

EX: If the Camera ID is 1, set the ID number as follows.

### Setting Camera ID Switch (Camera Holder)

Camera ID	SW2	SW1	Remarks	Camera ID	SW2	SW1	Remarks
ID = 0	0	0	N/A	ID = 48	3	0	
ID = 1	0	1		ID = 49	3	1	
ID = 2	0	2		ID = 50	3	2	
ID = 3	0	3		ID = 51	3	3	
ID = 4	0	4		ID = 52	3	4	
ID = 5	0	5		ID = 53	3	5	
ID = 6	0	6		ID = 54	3	6	
ID = 7	0	7		ID = 55	3	7	
ID = 8	0	8		ID = 56	3	8	
ID = 9	0	9		ID = 57	3	9	
ID = 10	0	A		ID = 58	3	A	
ID = 11	0	B		ID = 59	3	B	
ID = 12	0	C		ID = 60	3	C	
ID = 13	0	D		ID = 61	3	D	
ID = 14	0	E		ID = 62	3	E	
ID = 15	0	F		ID = 63	3	F	
ID = 16	1	0		ID = 64	4	0	
ID = 17	1	1		ID = 65	4	1	
ID = 18	1	2		ID = 66	4	2	
ID = 19	1	3		ID = 67	4	3	
ID = 20	1	4		ID = 68	4	4	
ID = 21	1	5		ID = 69	4	5	
ID = 22	1	6		ID = 70	4	6	
ID = 23	1	7		ID = 71	4	7	
ID = 24	1	8		ID = 72	4	8	
ID = 25	1	9		ID = 73	4	9	
ID = 26	1	A		ID = 74	4	A	
ID = 27	1	B		ID = 75	4	B	
ID = 28	1	C		ID = 76	4	C	
ID = 29	1	D		ID = 77	4	D	
ID = 30	1	E		ID = 78	4	E	
ID = 31	1	F		ID = 79	4	F	
ID = 32	2	0		ID = 80	5	0	
ID = 33	2	1		ID = 81	5	1	
ID = 34	2	2		ID = 82	5	2	
ID = 35	2	3		ID = 83	5	3	
ID = 36	2	4		ID = 84	5	4	
ID = 37	2	5		ID = 85	5	5	
ID = 38	2	6		ID = 86	5	6	
ID = 39	2	7		ID = 87	5	7	
ID = 40	2	8		ID = 88	5	8	
ID = 41	2	9		ID = 89	5	9	
ID = 42	2	A		ID = 90	5	A	
ID = 43	2	B		ID = 91	5	B	
ID = 44	2	C		ID = 92	5	C	
ID = 45	2	D		ID = 93	5	D	
ID = 46	2	E		ID = 94	5	E	
ID = 47	2	F		ID = 95	5	F	



## Part Names and Functions



Camera ID	SW2	SW1	Remarks
ID = 96	6	0	
ID = 97	6	1	
ID = 98	6	2	
ID = 99	6	3	
ID = 100	6	4	
ID = 101	6	5	
ID = 102	6	6	
ID = 103	6	7	
ID = 104	6	8	
ID = 105	6	9	
ID = 106	6	A	
ID = 107	6	B	
ID = 108	6	C	
ID = 109	6	D	
ID = 110	6	E	
ID = 111	6	F	
ID = 112	7	0	
ID = 113	7	1	
ID = 114	7	2	
ID = 115	7	3	
ID = 116	7	4	
ID = 117	7	5	
ID = 118	7	6	
ID = 119	7	7	
ID = 120	7	8	
ID = 121	7	9	
ID = 122	7	A	
ID = 123	7	B	
ID = 124	7	C	
ID = 125	7	D	
ID = 126	7	E	
ID = 127	7	F	
ID = 128	8	0	
ID = 129	8	1	
ID = 130	8	2	
ID = 131	8	3	
ID = 132	8	4	
ID = 133	8	5	
ID = 134	8	6	
ID = 135	8	7	
ID = 136	8	8	
ID = 137	8	9	
ID = 138	8	A	
ID = 139	8	B	
ID = 140	8	C	
ID = 141	8	D	
ID = 142	8	E	
ID = 143	8	F	
ID = 144	9	0	
ID = 145	9	1	

Camera ID	SW2	SW1	Remarks
ID = 146	9	2	
ID = 147	9	3	
ID = 148	9	4	
ID = 149	9	5	
ID = 150	9	6	
ID = 151	9	7	
ID = 152	9	8	
ID = 153	9	9	
ID = 154	9	A	
ID = 155	9	B	
ID = 156	9	C	
ID = 157	9	D	
ID = 158	9	E	
ID = 159	9	F	
ID = 160	A	0	N/A
ID = 161	A	1	
ID = 162	A	2	
ID = 163	A	3	
ID = 164	A	4	
ID = 165	A	5	
ID = 166	A	6	
ID = 167	A	7	
ID = 168	A	8	
ID = 169	A	9	
ID = 170	A	A	
ID = 171	A	B	
ID = 172	A	C	
ID = 173	A	D	
ID = 174	A	E	
ID = 175	A	F	N/A
ID = 176	B	0	
ID = 177	B	1	
ID = 178	B	2	
ID = 179	B	3	
ID = 180	B	4	
ID = 181	B	5	
ID = 182	B	6	
ID = 183	B	7	
ID = 184	B	8	
ID = 185	B	9	
ID = 186	B	A	
ID = 187	B	B	
ID = 188	B	C	
ID = 189	B	D	
ID = 190	B	E	
ID = 191	B	F	
ID = 192	C	0	
ID = 193	C	1	
ID = 194	C	2	
ID = 195	C	3	

Camera ID	SW2	SW1	Remarks
ID = 196	C	4	
ID = 197	C	5	
ID = 198	C	6	
ID = 199	C	7	
ID = 200	C	8	
ID = 201	C	9	
ID = 202	C	A	
ID = 203	C	B	
ID = 204	C	C	
ID = 205	C	D	
ID = 206	C	E	
ID = 207	C	F	
ID = 208	D	0	
ID = 209	D	1	
ID = 210	D	2	
ID = 211	D	3	
ID = 212	D	4	
ID = 213	D	5	
ID = 214	D	6	
ID = 215	D	7	
ID = 216	D	8	
ID = 217	D	9	
ID = 218	D	A	
ID = 219	D	B	
ID = 220	D	C	
ID = 221	D	D	
ID = 222	D	E	
ID = 223	D	F	
ID = 224	E	0	
ID = 225	E	1	
ID = 226	E	2	
ID = 227	E	3	
ID = 228	E	4	
ID = 229	E	5	
ID = 230	E	6	
ID = 231	E	7	
ID = 232	E	8	
ID = 233	E	9	
ID = 234	E	A	
ID = 235	E	B	
ID = 236	E	C	
ID = 237	E	D	
ID = 238	E	E	
ID = 239	E	F	
ID = 240	F	0	
ID = 241	F	1	
ID = 242	F	2	
ID = 243	F	3	
ID = 244	F	4	
ID = 245	F	5	

Camera ID	SW2	SW1	Remarks
ID = 246	F	6	
ID = 247	F	7	
ID = 248	F	8	
ID = 249	F	9	
ID = 250	F	A	
ID = 251	F	B	
ID = 252	F	C	
ID = 253	F	D	
ID = 254	F	E	
ID = 255	F	F	



### Notes

- Factory Setting: Camera ID = 1

## Part Names and Functions

The following 3 Camera ID's cannot be used.

Camera ID	R-SW2	R-SW1
ID = 0	0	0
ID = 160	A	0
ID = 175	A	F

### Setting Transmission Mode (Camera Holder)

Set the transmission mode using the ON/OFF of the Dip Switch 1.

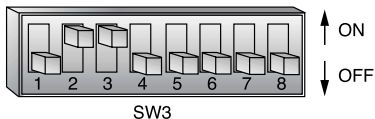

SW3- #1	Function	ON	OFF
	Transmission Mode Selection	Full Duplex (DVR)	Half Duplex (SCC-16/SCC-3000/3100)

#### Notes

- Factory Setting: OFF

### Setting RS-485/RS-422A Termination (Camera Holder)

Set the termination using the ON/OFF of 2, 3, 4, 5 of the Dip Switch 3.

Location of Camera Connection	SW3- #2	SW3- #3	SW3- #4	SW3- #5
Termination of Longest Path	ON	ON	ON	ON
On the Path	OFF	OFF	OFF	OFF

#### Notes

- Factory Settings: Only #2 and #3 are ON.

### Setting Communication Method (Camera Holder)

SW3- #6	Function	ON	OFF
	Factory Release	RS-422	RS-485

#### Notes

- Factory Setting: OFF

### Setting for Factory Adjustment (Camera Holder)

SW3- #7	Function	ON	OFF
	Factory Release	Always OFF	

#### Notes

- Factory Setting: OFF

### PC Communication Setting (Camera Holder): For reservation

SW3- #8	Function	ON	OFF
	PC Communication	RS-232	RS-485/422

#### Notes

- Factory Setting: OFF

## Part Names and Functions

### Controller Connection Terminal (Camera Holder)

	NAME	Purpose
CON7 - #1	RXD+	Controller Data Line Connection
CON7 - #2	RXD-	Controller Data Line Connection
CON7 - #3	TXD+	Controller Data Line Connection
CON7 - #4	TXD-	Controller Data Line Connection
CON7 - #5	GND	GND
CON7 - #6	TX	For RS-232 Communication
CON7 - #7	RX	For RS-232 Communication

### Alarm Connection Terminal (Camera Holder)

	NAME	Purpose
JP3 - #1	IN1	Alarm input sensor connection terminal 1
JP3 - #2	IN2	Alarm input sensor connection terminal 2
JP3 - #3	GND	GND
JP3 - #4	IN3	Alarm input sensor connection terminal 1
JP3 - #5	IN4	Alarm input sensor connection terminal 1
JP3 - #6	GND	GND
JP3 - #7	COM1	Alarm Output 1 Common
JP3 - #8	1N.C	Alarm Output 1 (for Normal Close)
JP3 - #9	1N.O	Alarm Output 1 (for Normal Open)
JP3 - #10	COM2	Alarm Output 2 Common
JP3 - #11	2N.C	Alarm Output 2 (for Normal Close)
JP3 - #12	2N.O	Alarm Output 2 (for Normal Open)

### Setting Termination Resistance

In order to prevent signal reduction, the termination resistance of the 2 end units, which are the distant paths for camera and controller to be connected on the RS485 interface, should be connected.

As the termination resistance is built in the camera, whether to make the termination resistance valid or invalid is selected with the DIP switch.

See the connection diagram below for determining to which device the termination resistance will be connected to.

Set up the termination resistance in the dark products.

The installation distance of the product for the termination resistance setting should be less than 1.2 Km. (Maximum cable length is 1.2 Km according to the RS-485 standards.)

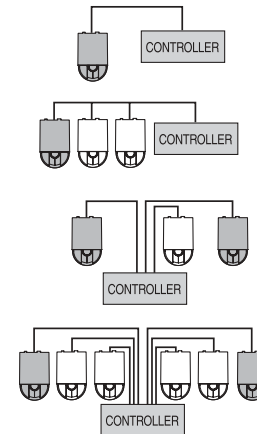

## Accessories

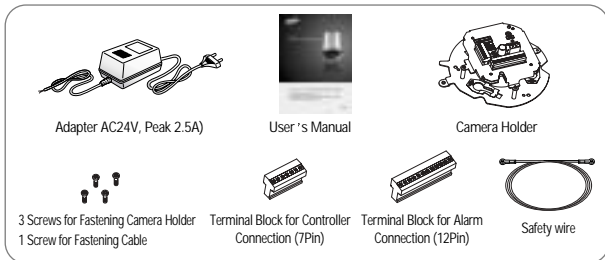

## Products Sold Separately

The following products are provided separately.

Item	Model	Description
On-Ceiling Mount	STB-330PC	Mounted on the ceiling surface
Camera Controller	SCC-16	Pan/Tilt/Zoom/Focus control, OSD, Setting various functions
Camera Controller	SCC-3000/3100	Pan/Tilt/Zoom/Focus control, OSD, Setting various functions
Indoor Housing	STH-330PI	Housing for indoor installation
Indoor Insertion Housing	STH-330PE	Installation by inserting the camera into the indoor ceiling
Outdoor Housing	STH-330PO	Output DC 12V (including heater and fan)
Wall Type Mount	STB-270PW	Attachment to the wall
Ceiling Type Mount	STB-496PP	Attachment to the ceiling

### Notes

- See pages 25 and 26 for product images.

## Preparation for Cable

To install and use the SPD-3000/2300, the following cables should be used.

- **Power Adapter Cable**  
The cable connected to the power input terminal of SPD-3000/2300 is shown below with a rated voltage of AC24V 2.5A.

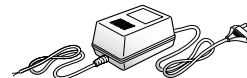

- **Video Cable**  
The cable connected to the video output terminal and to the monitor of SPD-3000/2300 is the BNC cable shown below.

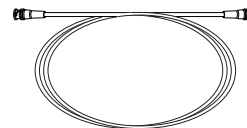

- **Communications Cable**  
The cable connected to the controller of SPD-3000/2300 for RS-485/422 communication is shown below.

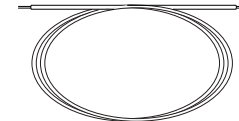

### Notes

- Video cable and RS-485/422 communication cable are not provided in this product's package.

# Installation

## Cable Connection

1. First, connect one end of the BNC video cable connector to the Video Output Terminal.
2. Next, connect the other end of the connector to the Video Input Terminal of the monitor.
3. Then, connect the Power Adapter Cable. Use a driver (-) to screw one part of the Power Adapter consisting of two lines to the Power Input Terminal of the camera holder.

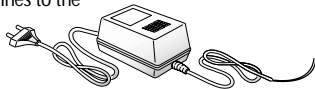
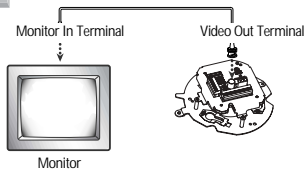

4. Connect the Power Adapter's plug to the Power Outlet.

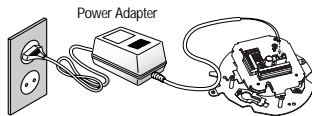

5. Connect the Controller Connection Terminal of SPD-3000/2300 and the external Controller.

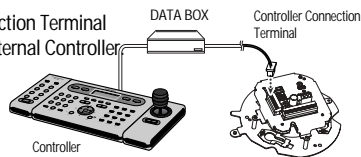

## Installation of SPD-3000/2300

### Installation Precautions

- Check out the installation place. It should be strong enough to support more than 4 times the total product weight including speed dome camera (SPD-3000/2300) and installation structure.
- Install the camera in a place having more than 500mm of space above the ceiling board.
- Install the camera holder using the provided installation guide tab, screw and fastening cable.
- There is a risk of camera falling during installation. Prevent the fall using the fastening cable while installing the camera. Also, access of other people to the place should not be allowed during installation.

### Accessories Sold Separately

Use the following accessories sold separately for convenient installation depending on installation places.

#### 1) On-Ceiling Installation Mount (STB-330PC)

This mount is used to install the camera on the ceiling.

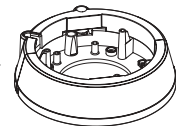

#### 2) Indoor Insertion Housing (STH-330PE)

This housing is used to attach the speed dome camera to the ceiling for installation.

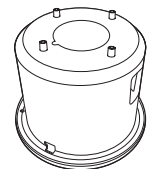

## Installation

### 3) Indoor and Outdoor Housing (STH-330PI, STH-330PO)

This housing is used to install the speed dome camera on the indoor or outdoor wall or ceiling. (For the indoor type, the fan and heater are excluded.)



### 4) Wall Type Mount (STB-270PW)

This item is used to install the indoor or outdoor housing for speed dome on the wall.

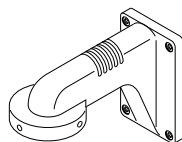

### 5) Ceiling Type Mount (STB-496PP)

This item is used to install the indoor and outdoor housing for speed dome on a concrete ceiling.

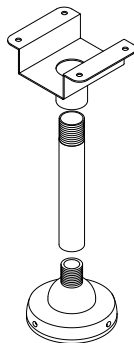

## Camera Installation (outdoor Housing)

1. Fasten the ceiling mount on the ceiling.

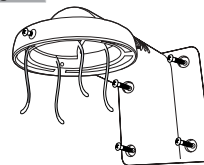

2. Pull outside of the housing the safety wire fastened to the outdoor housing.

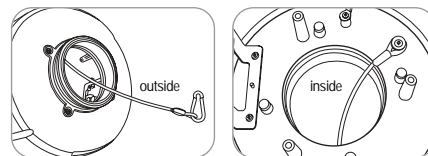

3. Connect the fan heater PCB cable inside the housing to the camera holder connector.

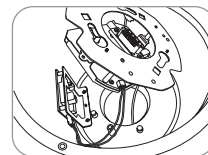

4. Match the arrow sign marked on the camera holder to the arrow marked inside the housing and then install the camera holder in the housing.

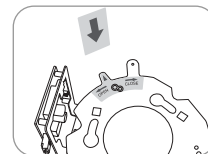

## Installation

5. Connect the heater and fan cables within the housing to the fan heater PCB.

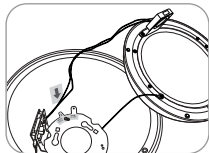

6. Adjust and make the arrows marked on the bottom of the camera body face each other.

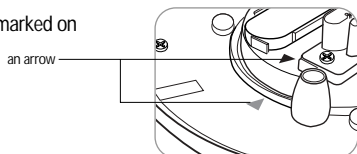

7. Insert the camera into the housing by matching the installation pin on the bottom of the camera and the arrow inside the housing, and then fasten the camera by inserting into the fastening hole, turning the screw clockwise for fastening.

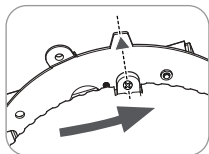

8. Remove the camera dome cover and then attach the housing dome cover.

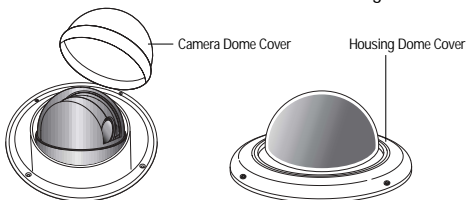

9. Connect the housing safety wires to the fixture inside the mount installed on the ceiling.

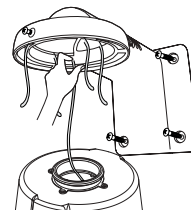

10. Connect the video cable, the controller cable, the power adapter cable and ID cable to the camera holder.

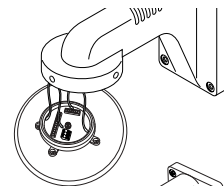

11. Check out the connection of all parts and the camera and install the completed outdoor housing on the ceiling mount.

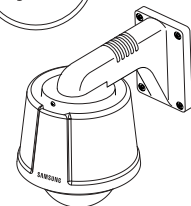

### Notes

- Check out the input voltage of the power adapter before connecting the power.
- For an installation without housing, the camera can be installed with installation template, fastening the cable and screw provided separately.
- It is necessary to tighten the screw to prevent unfastening.
- If the screw to prevent unfastening is not tight, the camera installed may fall due to vibration or shock from the environment.
- Set up the Camera ID, the Termination Resistance and the Protocol Selection Switch before installing the outdoor housing on the ceiling type mount.

# Functional Description

## OSD Menu Organization

Dome camera can be set up on the OSD (On Screen Display) menu displayed on the video monitor by the camera controller. The joystick operations in the OSD menu are as follows. In addition, sending control codes to the camera from the PC can also use the camera functions.

### • Menu Organization

Menu	Function	Menu	Function
TILT UP	Move up on the OSD menu	PAN LEFT	Move left on the OSD menu
TILT DOWN	Move down on the OSD menu	PAN RIGHT	Move right on the OSD menu

P1	P2	P3	P4	Defaults		
① Camera Setting	① Focus	① Focus Mode	Auto/Manual/One Shot AF	One Shot AF		
		② Zoom Tracking	Mode	On/Off	ON	
			Speed	Slow/Fast	Fast	
		③ Digital Zoom	Off(2-10X)		OFF	
	② White Balance	AWB Mode	ATW/AWC/MANUAL		ATW(O)	
			▶ ATW -ATW(): Indoor -ATW(O): Outdoor ▶ Manual -Red -Blue		30 40	
	③ Exposure	① Brightness	50		050	
			Auto		Auto	
		② Iris	Manual	Iris Level		050
			---			ESC
		③ Shutter	A.FLK			
	Manual		1/60-1/120,000,x2-x128		1/60	
	④ Sens-Up	Auto	Sens-Up Limit x2-x128		x4	
		Off				
	④ Back Light	On/Off			OFF	
	⑤ AGC	High/Middle/Low/Off			Middle	
	⑥ SSNR	High/Middle/Low/Off			OFF	
⑦ Day & Night	Auto		B/W Burst On/Off	OFF		
	B/W		Burst Level	150		
⑧ Others	① Sync	Internal		10		

P1	P2	P3	P4	Defaults	
① Camera Setting	⑧ Others	① Sync	Line Lock Line Lock Phase	225	
		② DIS	On/Off	OFF	
		③ Image Adj.	Sharpness	008	
			Color	050	
	④ Freeze	On/Off		OFF	
② Sequence Setting	① Preset	① Setting ② Edit ③ Execute ④ Clear ⑤ Status			
		① Pan Swing ① Setting ② Execute ③ Clear			
	② Swign SEO	① Tilt Swing ① Setting ② Execute ③ Clear			
		③ P/T Swing ① Setting ② Execute ③ Clear			
		① Group1 ① Setting ② Execute ③ Clear			
	③ Group SEO	② Group2 ① Setting ② Execute ③ Clear			
		③ Group3 ① Setting ② Execute ③ Clear			
		④ Group4 ① Setting ② Execute ③ Clear			
		⑤ Group5 ① Setting ② Execute ③ Clear			
		⑥ Group6 ① Setting ② Execute ③ Clear			
	④ Tour SEO	① Setting ② Execute ③ Clear			
	⑤ PTZ Trace	① Trace1 ① Replay ② Memorize			
		② Trace2 ① Replay ② Memorize			
		③ Trace3 ① Replay ② Memorize			
		④ Trace4 ① Replay ② Memorize			
	⑥ Auto Run	① Mode	① Off		OFF
			② reset Preset No		
③ Swing Swing Mode Pan/Tilt/P&T					
④ Group Group No					
⑤ Tour					
⑥ trace Trace1-Trace4					
⑦ A.Pan ① Auto Pan Speed 20-50				32	
② Tilt Angle 10-45				25	
⑧ time 1-59(Sec), 1-59(Min)				30 sec	
⑦ Power On Resume			On/Off		OFF
③ P/T Setting	① Pan Limit	① position ② ON/OFF			
		② Tilt Limit ① position ② ON/OFF			
	③ Area Setting	① Area1	① Area Name ② Position ③ ON/OFF		
		② Area2			
		③ Area3			
		④ Area4			



# Functional Description



P1	P2	P3	P4	Defaults	
③ P/T Setting	③ Area Setting	⑤ Area5	① Area Name ② Position ③ ON/OFF		
		⑥ Area6			
		⑦ Area7			
		⑧ Area8			
	④ Area Masking	① Mask1	① Position ② ON/OFF		
		② Mask2			
③ Mask3					
④ Mask4					
	⑤ Prop. P/T	ON / OFF		ON	
	⑥ Digital Flip	ON / OFF		ON	
④ OSD Setting	① Camera ID	ON / OFF		ON	
	② Camera Name	① Edit ② ON / OFF			
	③ Preset Number	ON / OFF		ON	
	④ Preset Name	① Edit ② ON / OFF			
	⑤ Sequence Status	ON / OFF		ON	
	⑥ Area Name	ON / OFF		OFF	
	⑦ PTZ Position	ON / OFF		OFF	
	⑧ Language	English/Chinese		English	
⑤ Alarm Setting	① Alarm Enable	ON / OFF		OFF	
	② Alarm Input	① Alarm1	NC/NO/COM		
		② Alarm2	1-4(Priority)		
		③ Alarm2	Preset/Group/Tour		
		④ Alarm2	A.Pan/Trace		
		⑤ Alarm2	1-4, MD		
	③ Alarm Out	① Setting1	1-4, MD		
		② Setting2	1-4, MD		
		③ Timer1	①	1-59(Sec)	
			②	1-59(Min)	
			③	1-59(Hour)	
			④	1-59(Sec)	
		④ Timer2	①	1-59(Min)	
			②	1-59(Hour)	
	③		1-59(Hour)		
	⑤ Out Off1				
	⑥ Out Off2				
	④ MD Dwell Time	ON / OFF	1-59(Sec) / 1-59(Min)	30sec	
⑥ Initialize	① Power On Reset	① Cancel ② execute			
	② Factory Default Set	① Cancel ② execute			
	③ Camera Default Set	① Cancel ② execute			
	④ Auto Refresh	OFF, 1-7Days		OFF	
⑦ Status					



## Notes

- Preset setting is only possible on the OSD menu or using the controller.

## Symbol Description

- Auto Run in the Sequence Mode
  - "A" symbol is flashing on the right top of the screen.
- Motion Stabilization Stand-by Operation
  - "D" symbol is flashing on the right top of the screen.
- Alarm operation
  - "⚡" symbol is flashing on the right top of the screen.
- Alarm Input #1, 2, 3, 4 Sensor Operation
  - "①", "②", "③" and "④" symbols are flashing on the right top of the screen.
- Alarm Output #1, 2 Sensor Operation
  - "①" and "②" symbols are flashing on the right top of the screen.
- Motion Detect Operation
  - "Man Icon" is flashing on the right top of the screen.
- When there are sub menus under the selected OSD menu
  - Numbers are displayed in white colour like ① on the right top of the screen.
- When there is no sub menu under the selected OSD menu
  - Numbers are displayed in black colour like ① on the right top of the screen.

# Functional Description

## Dome Camera User Menu Settings

- Execution of OSD Menu :  
After checking if the camera is in manual operation mode, press the OSD Menu key or 1+MENU (SCC-16 Model). The following commands are displayed on the monitor screen.

- Main Menu

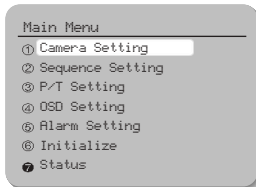

The selection key moves up and down. Press the execution key switch on the selected menu to change the setup menu. Press the ESC key to exit the OSD Menu.

### 1) Camera Setting

Select the Camera Setting on the Main Menu screen to control camera settings

- Camera Setting Menu

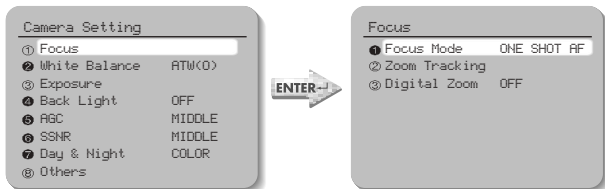

## FOCUS

In Focus menu, you can set up the focus mode among Auto, Manual or One Shot AF.

### ① Focus Mode

- ▶ Auto : The camera adjusts the focus automatically while monitoring the screen continuously in the auto mode. In the auto focusing mode, zoom key operation is not recognized as the input of the focus key.
- ▶ Manual : In the manual mode, users can adjust the camera focus manually.
- ▶ One Shot AF : Only when the camera does not move, it turns into the auto mode. It is the same as the manual mode.

### ② Zoom Tracking

- ▶ Mode: When you select ON, the Focus function is executed when the Zoom function is on. When you select OFF, the Focus function is not executed even when the Zoom function is on.
- ▶ Speed: Fast will speed up the Zoom. Slow will slow down the Zoom.

### ③ Digital Zoom

Magnification of the Digital Zoom can be selected among Off, 2X~10X.

\*It is recommended that the Digital Zoom should be set up before the preset operation.



### Notes

- Digital Zoom
  - As the digital zoom magnification increases, the image quality is lowered.
- Auto-focus
  - Auto-focus may not function normally under the following conditions.
    - When the light level in the surveillance area is low
    - When the slow-shutter works
    - When the amplification is increased
    - When the light level in the surveillance area is excessively high
    - When the objects in the long and short distance are under the same surveillance area
    - When there is no contrast (white and black) in the object (e.g. sky or wall)
    - When the thin horizontal line is captured

## Functional Description

### White Balance

The White Balance function corrects the abnormal white colour into the normal white colour under any colour temperature lighting. Select the mode among ATW, AWC and Manual. ATW is selected by default.

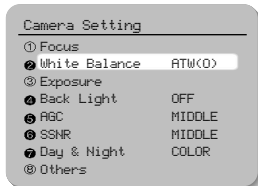

#### WB Mode

▶ATW: Balances the colour automatically depending on the source of light from 1,800–10,500K colour temperature.

\* Indoor[ATW(I)] : Use this mode in the area under the limited colour temperature.

\* Outdoor[ATW(O)] : Use this mode in the area under the broad colour temperature.

▶AWC: Set up the lighting to the objects and corrects the right colour temperature to that of a white object. Camera works under the setup conditions. For the most appropriate condition under the current illumination, capture the white paper and then change the mode into AWC. Press the Enter key and then AWC Start will be displayed. When the adjustment is completed after pressing the Enter key for AWC Start, go to the upper menu. When conditions change, adjust the white balance function again.

▶Manual: Fine tuning is possible through this manual control mode. Select the colour temperature and increase or decrease the Red or Blue values to shift the colour of the object.

\* Red: Red Gain can be changed.

\* Blue: Blue Gain can be changed.



#### Notes

• White Balance may not function properly under the following conditions.

- ① When the colour temperature surrounding the object is very high. (e.g. clear sky or sunset)
- ② When it is dark around the object.
- ③ When the camera is pointing towards a fluorescent lamp directly or when lighting conditions change a lot.

### Exposure

Camera exposure can be controlled.

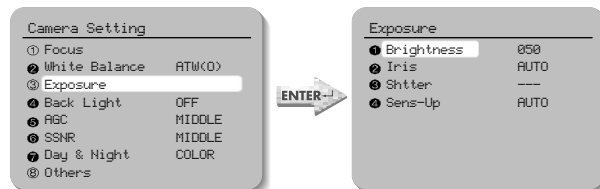

① Brightness: The brightness of the screen can be adjusted.

② Iris: Auto mode or manual mode can be selected.

▶Auto: The brightness of the image signal can be adjusted automatically depending on the amount of light.

▶Manual: The brightness of the image can be adjusted.

③ Shutter

▶---: Electronic shutter mode is enabled. The shutter speed is controlled automatically according to the brightness of the screen.

▶A.FLK: Use this mode when the screen flickers because of inconsistent frequency with the surrounding lights.

- ▶Manual: 1. Shutter speed can be controlled manually.  
2. Shutter speed can be adjusted from 1/60 second to 1/120,000 second.  
3. Sens-Up function can be operated manually from x2 ~ x128.



#### Notes

- If the Shutter mode is ESC in the inner synchronization mode and the camera faces to the bright fluorescent lamp directly, the image may be unstable. Be careful to select the installation location.
- If the Manual or A.FLK mode is selected for the Shutter menu, the Sens-Up function is disabled.

## Functional Description

### ④ Sens-Up

- ▶ Auto: The low light level of the night or dark condition is detected automatically and the bright and clear image can be maintained.
- ▶ Sens-Up Limit: Maximum accumulated magnification can be selected.
- ▶ Off: Sens-Up function is cancelled.



#### Notes

- As the accumulated magnification increases, the screen goes bright. But, the after image of the moving object also becomes larger and the optimum Auto Focus function may not work.

### Back Light

Unlike other cameras, Samsung Techwin's unique W-III DSP chip gives you a clear image of the subject even with bright backlight.

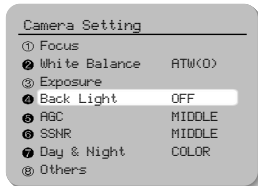

- ▶ ON : In contrasting lights, objects in the darker area also will show clearly in the picture.
- ▶ Off : BLC function is cancelled.

### AGC

When the brightness of the image taken under dark light is under a certain level, the AGC (Automatic Gain Control) functions to define whether to control the Gain automatically or not.

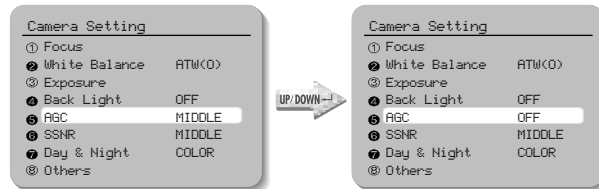

- ▶ Select one mode among High, Middle, Low or Off.

### SSNR (Samsung Super Noise Reduction)

SSNR function reduces background noise under low light conditions differently in different modes. The noise reduction effect grows in Off, Low, Middle and High modes in order.

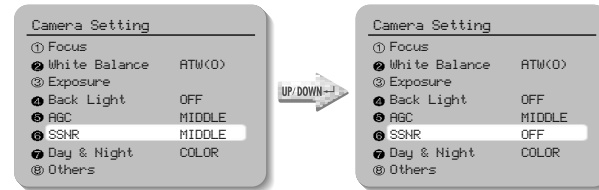

- ▶ OFF : No noise reduction effect.
- ▶ LOW : Noise reduction effect is small but there is little afterimage.
- ▶ MIDDLE : Noise reduction effect is generally effective in this mode. Noise can be reduced properly and the afterimage is not strong.
- ▶ HIGH : Noise reduction effect is excellent but afterimage is also strong.



#### Notes

- When you select the AGC mode as "OFF", you cannot use the SSNR function.

## Functional Description

### Day & Night

The darkness level is detected automatically under low light conditions such as at night or under dark light to keep the screen bright and clear.

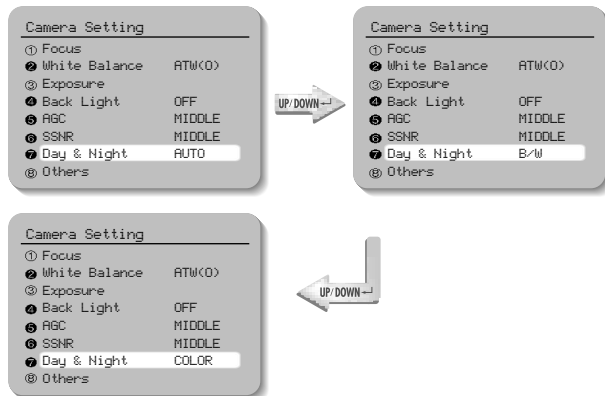

- ▶ **COLOR** : Output images are displayed in colour all the time. Burst signal size can be adjusted.
- ▶ **B/W** : Output images are displayed in black and white all the time. Burst signal can be kept or removed.
- ▶ **AUTO** : Under day condition, the mode is automatically changed into the COLOR mode to keep an optimum colour. At night, the mode is automatically changed into the B/W mode to distinguish dark images clearly.

#### Notes

- If the AGC is in OFF mode, the Auto mode cannot be used. Only COLOUR or B/W mode can be used.
- If the sunlight or halogen lamp is used in B/W mode, the focus may be blurred compared with the general illumination.

### Others

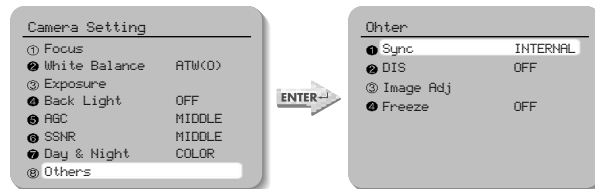

- ① **Sync**: Internal Sync or Line Lock can be selected. Internal Sync is selected by default. Line Sync function can adjust the output phase of more than 1 unit without using sync signal generator. When the AC Line Lock is selected, the phases can be adjusted from 0 to 360 levels. Accordingly, the phase can be adjusted up to 360°.
  - ▶ Internal : Internal synchronization
  - ▶ Line Lock : Power line synchronization
  - ▶ Line Lock Phase : The phase of line sync can be selected from 0° to 360°. Initial value is 225°.

- ② **DIS**(Digital Image Stabilizer) : Corrects camera shake.

#### Notes

- The DIS may not function properly under the conditions described below:
  1. Darkness (little or no light) around the subject
  2. No contrast on the subject
  3. Camera shake speed that is too fast and might not be corrected
  4. DIS is disabled while executing pan, tilt, zoom, or focus, or while displaying the camera settings menu.
  5. When DIS is ON, part of the screen is ignored before the correction is made. This results in narrower angle of view and reduction in resolution.

## Functional Description

- ③ Image Adj. : Clarity of the video signal and saturation of the color may be adjusted.
- ▶ Sharpness : The overall sharpness of the image can be adjusted.
  - ▶ Colour : The overall colour density of the image can be adjusted.
- ④ Freeze : Moving image can be stopped and replayed.
- ▶ ON : Image can be frozen.
  - ▶ OFF : Frozen image is released and the film is replayed.

## 2) Sequence Setting

- Sequence Setting Menu

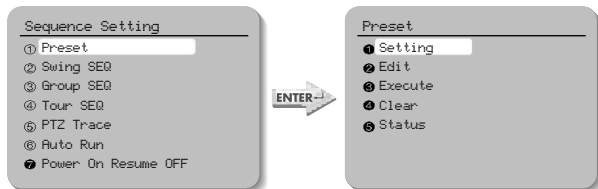

- ① Preset : 13 items such as Pan/Tilt location, Zoom and Focus are selected among camera functions and they can be called for monitoring. Total 128 points can be preset.

- ▶ Setting : Select the Preset number for setup. Adjust Pan/Tilt/Zoom and press the Enter key to save the setting. If you want to change the 13 items such as Focus, Brightness, Iris and Scene Adj., use the Up/Down key to go to and select the item. If you don't want to change the 13 items, press the ESC key to go to the next Preset step.
- ▶ Edit : You can edit the 13 preset items such as Pan/Tilt location, Zoom and Focus, which are selected among camera functions.
- ▶ Execute : Select the Preset number for execution.

- ▶ Clear : Select the Preset number to delete for clearing.
- ▶ Status : The current Preset number setup is displayed.

### • Motion Detection Setting

Select Motion Detection in the Preset Setting menu and then turn on the mode.



### Notes

- When the illumination is shaking under direct lighting such as a fluorescent lamp, it may cause malfunction of the camera. MD function is not recommended under this condition.
- When brightness of objects fluctuates suddenly due to lighting of flashlights or headlights or the lamp going on/off, it may cause malfunction of the camera.
- The purpose of this security function is not to prevent accidents or crimes such as fire or burglary. Our company is not responsible for the injury or damage caused by the inadequate use of this function.

### • Preset Menu Setting

1. Select the Preset item on the Sequence Setting Menu
2. Select the Setting item.

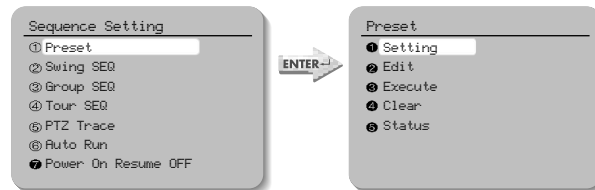

3. Select the Preset number.
4. Set up the Zoom and Focus.



## Functional Description

5. To change the camera settings, select Edit from the upper menu first. Select the item to change, and then make the necessary adjustments.

Preset Edit	[0011]
① PTZ	267/051/1X
② Focus Mode	Manual
③ Brightness	050
④ Iris	AUTO
⑤ Back Light	OFF
⑥ Day & Night	COLOR
⑦ Motion Det.	OFF
⑧ Scene Adj	

6. If you select the Scene Adj. item, such items as Shutter, AGC, SSSNR, Sens-Up, White Balance and DIS can be set up differently in every Preset item.

Scene Adj.	[0011]
① Shutter	---
② AGC	MIDDLE
③ SSSNR	MIDDLE
④ Sens-Up	AUTO
⑤ White Balance	ATW
⑥ DIS	OFF



### Notes

- In the White Balance setting of the individual Preset Scene Adj., the AWC selection is not available.

② Swing SEQ: Swing surveillance can be executed and set up and the data can be deleted.

Sequence Setting	Swing SEQ
① Preset	① Pan Swing
② Swing SEQ	② Tilt Swing
③ Group SEQ	③ P&T Swing
④ Tour SEQ	
⑤ PTZ Trace	
⑥ Auto Run	
⑦ Power On Resume OFF	

- ▶ Pan Swing : Swing surveillance for the Pan direction is executed and set up. Data is deleted.
- ▶ Tilt Swing : Swing surveillance for the Tilt direction is executed and set up. Data is deleted.
- ▶ P&T Swing : Swing surveillance both for the Pan and the Tilt directions are executed and set up simultaneously. Data is deleted.

\* Setting : The Preset Position for Swing function is selected with the joystick and confirmed with the Execution key. SPD is the moving speed (001-240/sec). DWL is the stop time (00-99 sec). Press the Execution key in the location with selection mark to finish the setting process.

\* Execute : Swing surveillance is executed. Stop key designates this function.

\* Clear : Data in the Swing function is deleted.

③ Group SEQ: Sequence surveillance can be executed and set up and data can be deleted. Up to 6 groups can be registered.

Sequence Setting	Group SEQ
① Preset	① Group 1
② Swing SEQ	② Group 2
③ Group SEQ	③ Group 3
④ Tour SEQ	④ Group 4
⑤ PTZ Trace	⑤ Group 5
⑥ Auto Run	⑥ Group 6
⑦ Power On Resume OFF	

▶ Setting : Preset position for swing is selected with the joystick and confirmed with the Execution key. SPD is the moving speed (001-240/sec). DWL is the stop time (00-99 sec). Press the Execution key in the location with selection mark to finish the setting process.

▶ Execute : Swing surveillance can be executed. Stop key will stop this function.

▶ Clear : Swing data can be deleted.

## Functional Description

④Tour : Group surveillance can be executed and set up and data can be deleted.

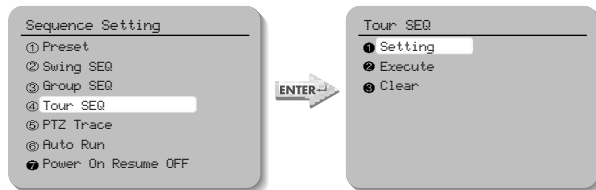

- ▶ Setting : The registered Group Sequence is selected with the joystick and confirmed with the Execution key. If the selected number is not registered, it cannot be input. Press the Execution key in the location with selection mark to finish the setting process.
- ▶ Execute : Group surveillance is executed.
- ▶ Clear : Group surveillance data are deleted.

⑤PTZ Trace : Maximum 4 patterns of the manual operation paths (for Pan, Tilt, Zoom and Focus) are memorized and replayed.

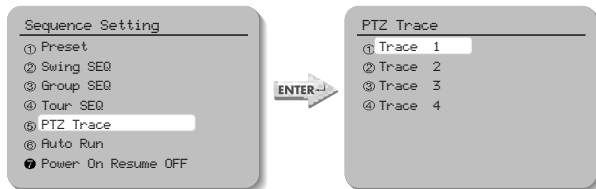

- ▶ Replay : The manual operation paths are repeated and replayed. Stop key will stop the replay.
  - \* If the operation range is limited using ①Pan Limit and ②Tilt Limit, please note that other operations beyond the limited operation range are not possible.
- ▶ Memorize : Manual operations for minimum 120 seconds after executing this function are memorized into the internal memory. Nevertheless, the memorizing time becomes different depending on the PTZ operation. OVER mark will finish this function.
  - \* If the operation range is limited using ①Pan Limit and ②Tilt Limit, only the operations within the limited range are memorized.



### Notes

- Press the OSD key to stop the internal memory to continue saving.

⑥Auto Run : If there is no controller operation by the user for a certain time, the sequence operation designated by the user will be executed.

- ▶ Mode - • OFF : Auto Run will be cancelled.
  - Preset : Auto Run in the corresponding Preset number
  - Swing : Auto Run in the corresponding Swing mode
  - Group : Auto Run in the corresponding Group number
  - Tour : Auto Run in the corresponding Tour number
  - Trace : Auto Run in the corresponding Trace number
  - A. Pan : 360° Auto Run in Pan direction

\* Auto Pan Speed: Pan operation in the speed designated by the user

\* Tilt Angle: The tilt angle set up by the user is kept.

- ▶ Time : Auto Run operation is executed after a certain time designated by the user.

\*Time can be set up by the unit of 1-59 sec and 1-59 min.

⑦Power On Resume : When the power supply for the camera is stopped for some reason, such as electricity failure, and resumed, the Sequence Settings before the power off are restored.

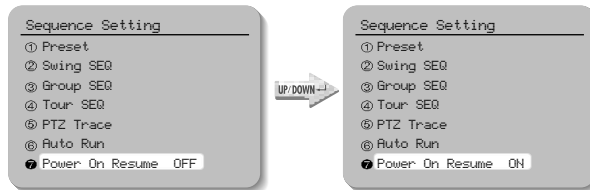



## Functional Description

### 3) P/T Setting

① Pan Limit : The moving range in the Pan direction can be limited.

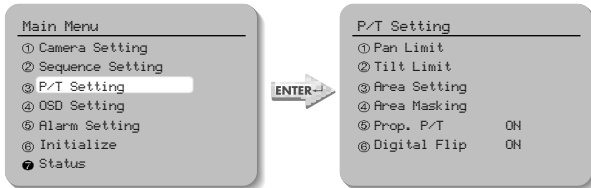

- ▶ Position : Moving range can be set up. Set the position from the left using the joystick and the Execution key. The stop position may change due to the initialization by such operation as power resumption depending on position setting. This does not mean it is out of order.
- ▶ On/Off : When this function is on, the limit is effective. Default setting is Off.

② Tilt Limit : Moving range in the tilt direction can be limited.

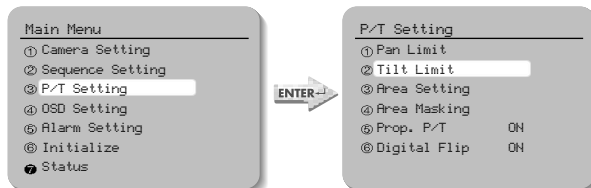

- ▶ Position : Moving range can be set up. Set the position from the top direction using the joystick and the Execution key. The stop position may change due to initialization by such operation as power resumption depending on position setting. This does not mean it is out of order.
- ▶ On/Off : The application of limitation will be determined. Default setting is Off.

③ Area Setting : Areas can be indicated. Areas can be designated up to 8.

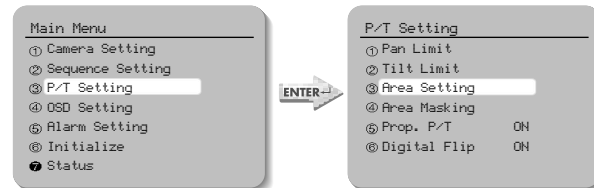

- ▶ Area Name : Area name can be set up. Use the joystick and the Execution key to enter the area name. A maximum of 12 letters (English, Chinese, numbers) can be entered. When you finish inputting the name, adjust the position mark to "SET" using the joystick and press the Execution key. This is the end of Area Name setting.
- ▶ Area Position : Area range can be designated. Use the joystick and the Execution key to determine the position from the left. If the area range is overlapped, the smaller area number will indicate the overlapping part.
- ▶ On/Off : It can be determined whether or not to activate the area mark. The activation becomes effective as soon as the position moves from the current area to other areas. Set up the OSD Setting as ON. If it is in OFF mode, this function does not work. Default setting is OFF.

④ Area Masking : If you want to exclude some areas for surveillance, they can be turned into black. You can mask 4 parts of one screen (maximum 32 parts).

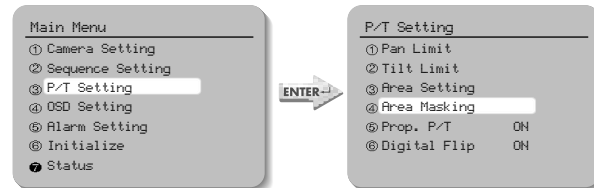

# Functional Description

- ▶ **Position** : Use the joystick and the Execution key to determine the position for screen operation from the left.
- ▶ **On/Off** : Operation of screen area masking can be determined. Default setting is OFF.

⑤ **Prop. P/T** : Pan and Tilt speeds can be changed depending on zoom magnification. Tele will slow down the speed of Pan/Tilt and Wide will increase the Pan/Tilt speed. It will take about 15 seconds for 1 cycle in Tele mode and about 1.5 seconds in the Wide mode. Default setting is ON.

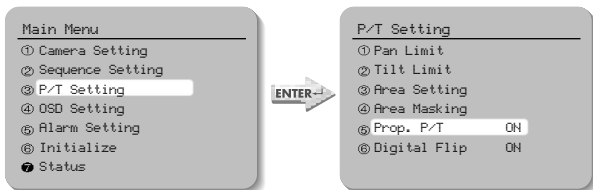

⑥ **Digital Flip** : When you operate the Tilt up to 90° limit using the joystick and keep it for a certain time, the image gets reversed automatically and the opposite Tilt area is seen. When you want to monitor the moving object under the camera, execute the Digital Flip function using the controller's joystick. You can observe the moving object without reversing of the screen.

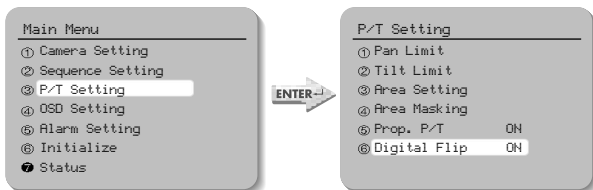

## 4) OSD Setting

① **Camera ID** (Default setting is ON) : Camera ID indication is set up.

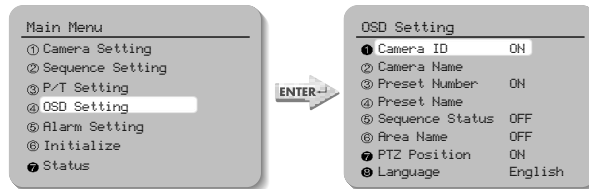

② **Camera Name** : Camera name is set up.

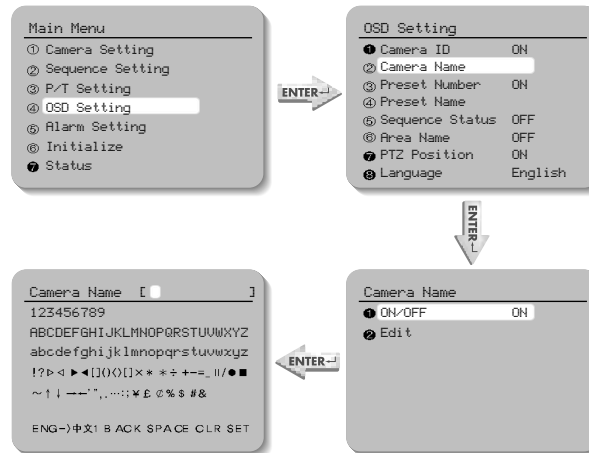

## Functional Description

- ▶ **Edit** : A maximum of 12 characters consisting of English (or Chinese, Japanese), numbers and special characters can be input for Camera Name.
- ▶ **On/Off** : The operation of this function is preset. Default setting is On.

### ③Preset Number (Default setting is ON.) : Preset numbering is set up.

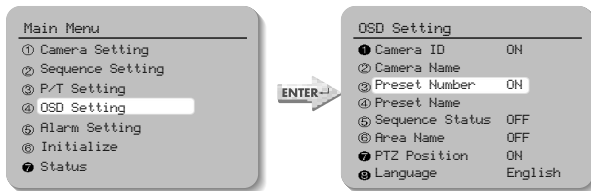

### ④Preset Name

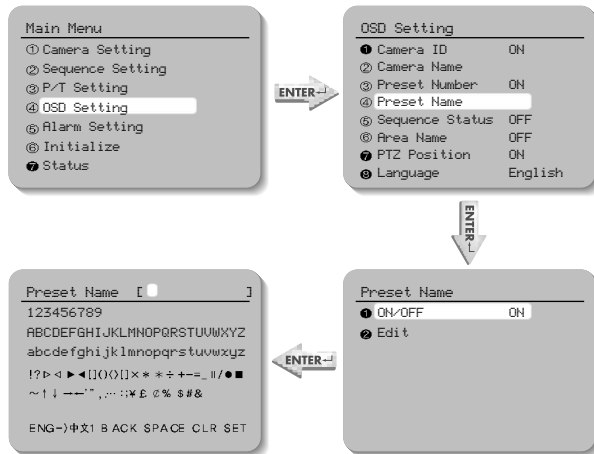

- ▶ **Edit** : A maximum of 12 characters consisting of English (or Chinese), numbers and special characters can be input for Preset Name.
- ▶ **On/Off** : The operation of this function is predetermined. Default setting is On.

### ⑤Sequence Status (Default setting is ON.) : Display of the Sequence Group is set up.

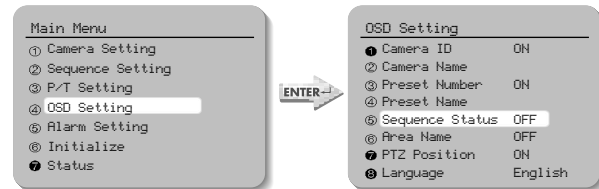

### ⑥Area Name : Display of Area Name is set up.

- When the Area Name is OFF, the Area Name cannot be displayed.

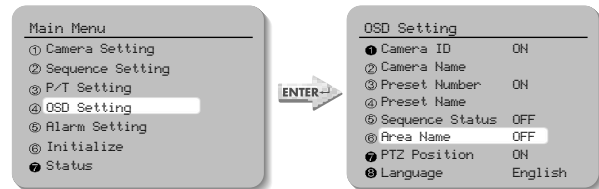

## Functional Description

7 PTZ Position : Pan and Tilt position and Zoom magnification are displayed.

- PTZ positions are not displayed in the OFF mode. (Only manual operation can display them.)

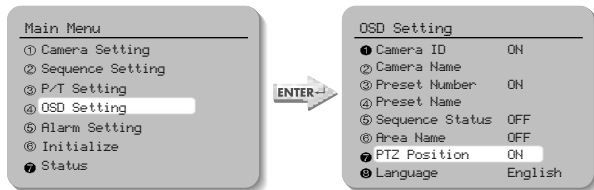

8 Language : The OSD can be displayed either in English (default setting) or in Chinese.

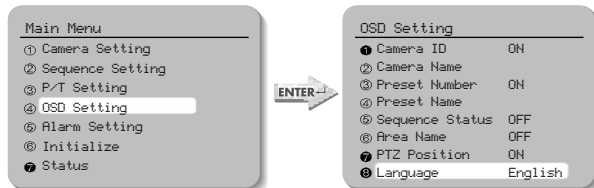

### 5) Alarm Setting

① Alarm Enable : It can be determined whether to enable the alarm setting.

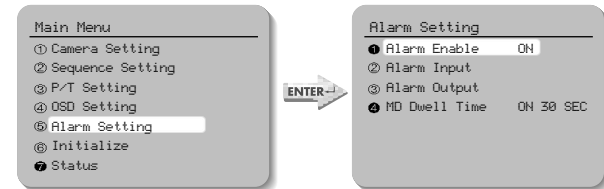

▶ ON/OFF : Alarm is enabled in ON mode.

② Alarm Input : Alarm Input Mode/Priority/Method is set up.

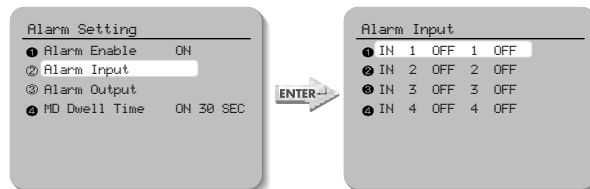

▶ NC/NO/OFF : NC/NO/OFF can be selected depending on the alarm sensor.

▶ 1 - 4 (Priority) : Priority for the 4 alarm inputs is set up. Response comes first from the alarm input of higher priority.

▶ Preset/Group/Tour Number :

Whether to enable the operation of Preset/Group/Tour by alarm input can be set up. When the alarm is input, it stays in the Preset/Group/Tour position for the Dwell Time set up by the Preset/Group/Tour Number of each alarm. The alarm in pattern is operated according to the pattern setting.

③ Alarm Out : One of the 2 Alarm Outs corresponds to each Alarm input.

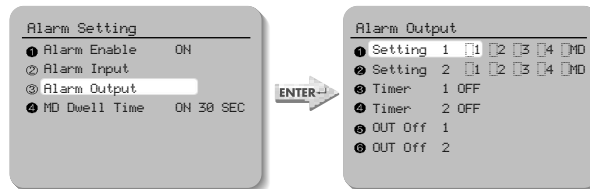

▶ OUT1 SET/OUT2 SET : One of the 4 Alarm Inputs corresponds to the 2 Alarm Outputs.

▶ OUT1 TIME/OUT2 TIME : For the 2 Alarm Outputs, On/Off and the operation time can be set up in the units of second/minute/hour. (1-59 sec, 1-59 min, 1-59 hour)

## Functional Description

▶ OUT1 OFF/OUT2 OFF : If you want to cancel the operating Alarm outputs at once, select the corresponding menu to cancel the operating Alarm.

- ④ MD Dwell Time: When the Motion Detection function is on, the motion of intruders can be detected. When the motion is detected, the Alarm signal is displayed in the Alarm Output Terminal. For detailed settings of the Motion Detection for each Preset menu, see page 43 and 44.

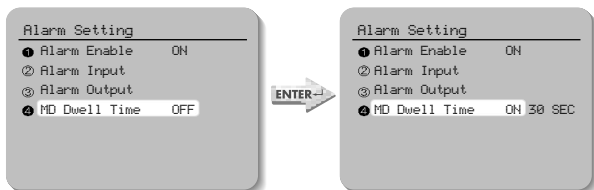

▶ ON/OFF : It can be set up how long the operation will be kept when the motion is detected. (1-59 sec, 1-59 min)

## 6) Initialization Setting

- Initialization Menu

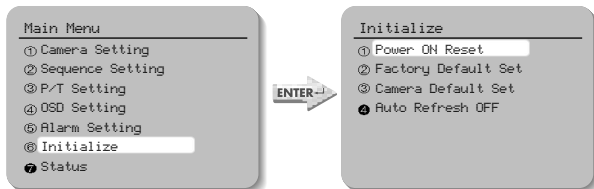

- ① Power On Reset : Camera is initialized into the original status of power input.

② Factory Default Settings : Camera is initialized into the factory default settings. Data including Preset is deleted. This function is used for initialization all settings.

③ Camera Default Settings: If only the camera module is replaced due to camera module failure, the new camera module can be set up with the settings of the old camera module.

④ Auto Refresh : The electric circuit and the status of the equipment parts within the camera are optimized regularly. (The cycle can be set up.) If camera faces toward a certain source of light or if the settings cannot be kept because of the long time rotation filming of a certain area, the Auto Refresh function is used to maintain and re-set the existing camera settings. Default setting is OFF.

▶ OFF, 1-7 Days : This function is disabled in the OFF mode. 1-7 Days enables the Auto Refresh operation in the interval of the selected days. Auto Refresh takes less than 10 seconds. The message "Auto Refresh" disappears after finishing the operation.

## 7) Status

The status of dome camera setting is displayed.

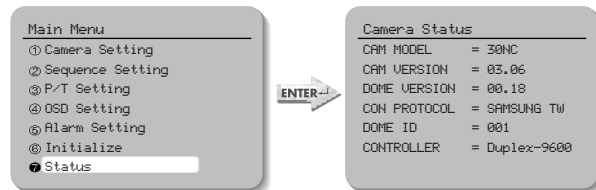

Cam Model = 30NC	Camera Model
Cam Version = 03.06	Camera S/W Version
Dome Version = 00.01	Control Board S/W Version
Dome ID=001	Dome Camera ID
Controller=Duplex-9600	Communication Mode Setup

## Product Structure and Installation

### Product Structure

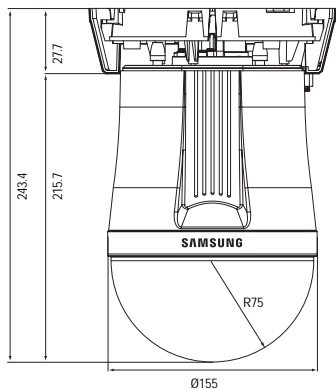
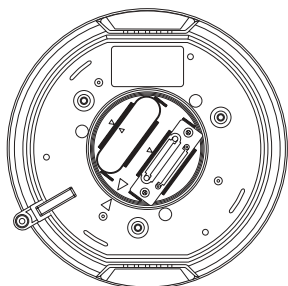

### Installation

#### Mount for On-Ceiling Type (STB-330PC)

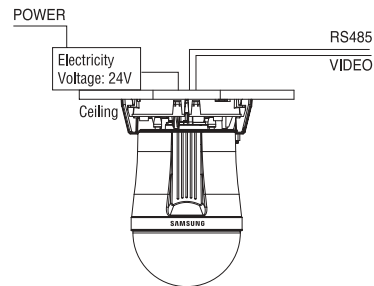

#### Case for In-Ceiling Type (STH-330PE)

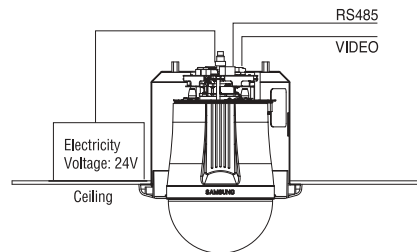

\*Other Installations: The outdoor installation accessories, which are sold separately, can be applied in various ways. (See 25 and 26 page for the accessories on sale.)

# Product Structure and Installation

## Installation 1

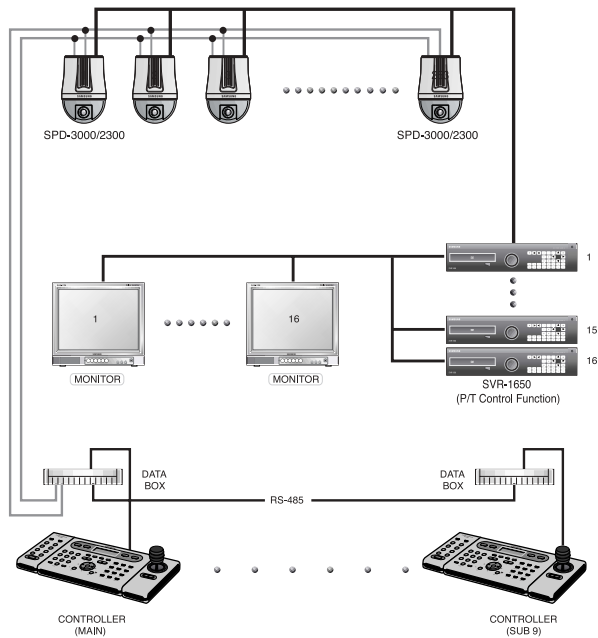

## Installation 2

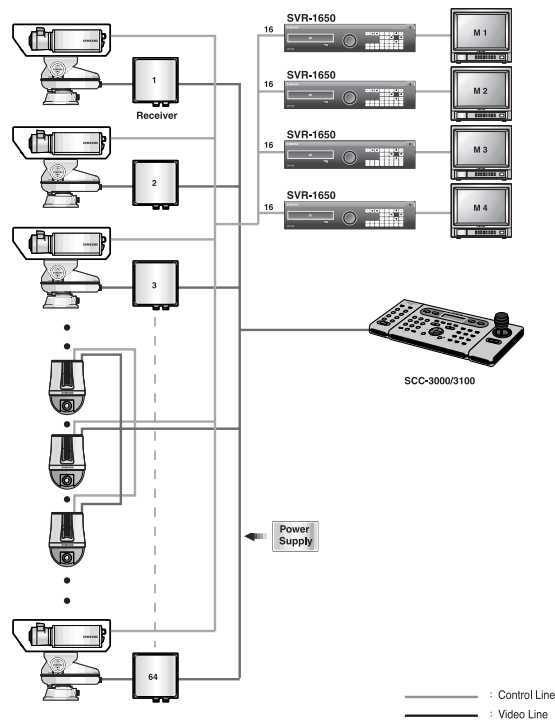

# Specifications



	SPD-3000	SPD-2300
Imaging device	1/4" Colour Vertical Double Density Interline CCD. 410,000pixel	
TV	NTSC	
Total Number of Pixels	811(H) X 508(V)	
Valid Pixel	768(H) X 494(V)	
Horizontal Scan Frequency	15.734kHz	
Vertical Scan Frequency	59.94Hz	
Synchronization	Internal Sync/External Sync(AC Line Lock)	
Image Output	1.0p-p/75Ω	
S/N Ratio	Higher than 50dB (AGC OFF)	
Horizontal Resolution	520 TV Lines (Colour)/570 TV Lines(B/W)	
Minimum Light for Object	0.7Lux(Color), 0.1Lux(B/W)(@50IRE), 0.0007Lux (Day & Night is On.)(@50IRE)	
Electronic Shutter	Auto/Manual (1/60 - 1/120,000)	
Sens-Up	ON (x2 - x128 Fields) / OFF	
Day&Night	ICR(Filter Switching) ON/OFF	
BLC	Camera Shake Correction: DIS (Digital Image Stabilizer) may be set to "On" or "Off"	
White Balance	ATW(Indoor/Outdoor Selection)/AWC/Manual (1,800K - 10,500K)	
Flickerless Adjustment	Fixed Shutter Speed (1/100)	
Iris	Auto/Manual (Iris Level Adjustment Mode)	
Gain Control	Low, Middle, High, Off	
OSD Display	ON/OFF	
Outline Correction	Adjustable Level	
Contact Point Distance	F3.3-99.0mm (30X Optical Zoom)	F3.84-88.4mm (23X Optical Zoom)
Digital Zoom	OFF, 2-10X Selection (Total 300X Zoom)	OFF, 2-10X Selection (Total 230X Zoom)
Maximum Aperture Rate	Ligh Angle 1: 1.6, Telescopic 1: 3.2	Ligh Angle 1: 1.6, Telescopic 1: 3.0
Coverage Angle	Wide:58.0(Horizontal)X44.8(Vertical) Tele:2.22(Horizontal)X1.68(Vertical)	Wide:52.5(Horizontal)X40.3(Vertical) Tele:2.36(Horizontal)X1.78(Vertical)
Proximity Distance	1.2m (Tele level)	
Horizontal Rotation Angle	360°	
Horizontal Rotation	Manual/Program	
Horizontal Rotation Speed	Manual: 0.5° ~ 120°/s(64 levels) Preset: 0.5° ~ 240°/s(64 levels)	
Horizontal Minimum Moving Angle	0.05°	

Accuracy of Horizontal Rotation Stop	0.30°
Vertical Rotation Angle	-4° ~ 184° (Digital Flip)
Vertical Rotation	Manual/Program
Vertical Rotation Speed	Manual: 0.5° ~ 120°/s(64 levels) Preset: 0.5° ~ 240°/s(64 levels)
Vertical Minimum Moving Angle	0.04°
Accuracy of Vertical Rotation Stop	0.30°
Preset Position	Max 128 points
Area Masking	Max 4 locations
Alarm	4 Alarm Inputs 2 Alarm Outputs (Relay: NC/NO/COM, 0.5A 125VAC, 2A 30VDC Max)
Operating Temperature	-10°C ~ +50°C
Operating Humidity	20% ~ 75%(Except for dew condensation)
Storage Temperature	-20°C ~ +60°C
Storage Humidity	20% ~ 95%(Except for dew condensation)
Power, Voltage	AC 24V±10%
Consumption Electricity	Standby 8 Watts, Operation 10 Watts
Dimension	Ø155 X 243.4mm
Weight	Less than 2.0kg
Installation Conditions	On-Ceiling Mount: STB-330PC Indoor: Indoor Housing (STH-330P), Indoor Insertion Type Housing (STH-330PE) Outdoor: Outdoor Housing (STH-330PO) Wall Installation Mount: STB-270PW Ceiling Installation Mount: STB-496PP

\* The product design and dimensions may change without previous notice for improvement of performance.

- The copyright of this manual belongs to Samsung Techwin Co. Ltd.
- Parts or the whole of this manual cannot be reproduced or transmitted by any electric, mechanic or audio method without the authorized written approval of Samsung Techwin.
- The contents of this manual may be changed for an improvement of functions.