

#### SALES NETWORK

**· SAMSUNG TECHWIN CO., LTD.**

145-3, Sangdaewon 1-dong, Jungwon-gu, Seongnam-si,  
Gyeonggi-do 462-703, Korea  
TEL : +82-31-740-8137-8141 FAX : +82-31-740-8145

**· SAMSUNG OPTO-ELECTRONICS AMERICA, INC.  
ELECTRONIC IMAGING DIV.**

40 Seaview Drive, Secaucus, NJ 07094, U.S.A  
TEL : +1-201-902-0347 FAX : +1-201-902-0429

**· SAMSUNG TECHWIN MOSCOW OFFICE**

Korp 14, 37-A, PR-KT, Leningradsky, Moscow 125167, Russia  
TEL : +7-95-258-9296,9298 FAX : +7-95-258-9297

**· SAMSUNG OPTO-ELECTRONICS UK, LTD.**

Samsung House, 1000 Hillswood Drive, Hillswood Business  
Park Chertsey, Surrey KT16 0PS  
TEL : +44-1932-45-5308 FAX : +44-1932-45-5325

**· TIANJIN SAMSUNG OPTO-ELECTRONICS CO., LTD.**

7 Pingchang Rd, Nankai Dist. Tianjin 300190, P.R China  
TEL : +86-22-2761-4724(33821) FAX : +86-22-2761-6514

[www.samsungtechwin.com](http://www.samsungtechwin.com)  
[www.samsungcctv.com](http://www.samsungcctv.com)

P/No. : Z6806-0660-02A

## HIGH RESOLUTION DAY & NIGHT COLOR CAMERA

### INSTRUCTION MANUAL

# SDC-415 SERIES

#### About this manual

Before installing and using the camera, please read this manual carefully. Be sure to keep it handy for later reference.

Thank you for purchasing a **SAMSUNG CCD CAMERA**.

Before operating the camera, confirm the camera model and proper input power voltage. In order that you can understand this manual thoroughly, we'll introduce our model description.

#### ■ SDC-415 SERIES

- NTSC MODELS
  - SDC-415ND
  - SDC-415NA
- PAL MODELS
  - SDC-415PD
  - SDC-415PA
  - SDC-415PH

#### ■ MODEL DESCRIPTION

- SDC-415X X

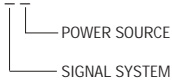

#### • SIGNAL SYSTEM

- N --> NTSC MODEL
- P --> PAL MODEL

#### • POWER SOURCE

- D --> DC 12V
- A --> AC 24V~
- H --> AC 230V~

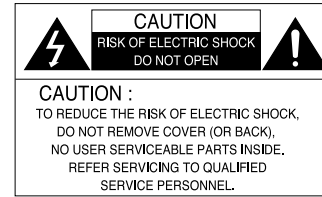

The lightning flash with an arrowhead symbol, within an equilateral triangle is intended to alert the user to the presence of uninsulated "dangerous voltage" within the product's enclosure that may be of sufficient magnitude to constitute a risk of electric shock to persons.



The exclamation point within an equilateral triangle is intended to alert the user to the presence of important operating and maintenance (servicing) instructions in the literature accompanying the appliance.

**INFORMATION** - This equipment has been tested and found to comply with limits for a Class A digital device, pursuant to part 15 of the FCC Rules. These limits are designed to provide reasonable protection against harmful interference when the equipment is operated in a commercial environment. This equipment generates, uses, and can radiate radio frequency energy and, if not installed and used in accordance with the instruction manual, may cause harmful interference to radio communications.

Operation of this equipment in a residential area is likely to cause harmful interference in which case the user will be required to correct the interference at his own expense.

**WARNING** - Changes or modifications not expressly approved by the manufacturer could void the user's authority to operate the equipment.

**WARNING :** To prevent electric shock and risk of fire hazards:

- ◆ Do NOT use power sources other than that specified.
- ◆ Do NOT expose this appliance to rain or moisture.

This installation should be made by a qualified service person and should conform to all local codes.

**Correct Disposal of This Product**  
(Waste Electrical & Electronic Equipment)  
(Applicable in the European Union and other European countries with separate collection systems)

This marking shown on the product or its literature, indicates that it should not be disposed with other household wastes at the end of its working life. To prevent possible harm to the environment or human health from uncontrolled waste disposal, please separate this from other types of wastes and recycle it responsibly to promote the sustainable reuse of material resources.

Household users should contact either the retailer where they purchased this product, or their local government office, for details of where and how they can take this item for environmentally safe recycling. Business users should contact their supplier and check the terms and conditions of the purchase contract. This product should not be mixed with other commercial wastes for disposal.

# Contents



|                              |    |
|------------------------------|----|
| Features                     | 6  |
| Warnings and precautions     | 7  |
| Components                   | 10 |
| Names and functions of parts | 11 |
| ■ Front                      | 11 |
| ■ Side                       | 12 |
| ■ Bottom                     | 13 |
| ■ Back                       | 14 |
| Installation                 | 15 |
| ■ Lens                       | 15 |
| • Using auto iris            |    |
| • Using C/CS mount lens      |    |
| ■ Connecting to a monitor    | 18 |
| ■ Connecting to power        | 19 |

|   |    |
|---|----|
| Camera operation                        | 20 |
| ■ Menu                                  | 20 |
| ■ Settings                              | 21 |
| • LENS (selection)                      | 22 |
| • SHUTTER (condition and speed control) | 24 |
| • WHITE BALANCE control                 | 25 |
| • BACKLIGHT (Backlight Compensation)    | 26 |
| • AGC (Auto gain compensation)          | 27 |
| • SSNR (Samsung Super Noise Reduction)  | 27 |
| • SENS-UP                               | 28 |
| • SPECIAL                               | 30 |
| • EXIT                                  | 35 |

|                 |    |
|-----------------|----|
| Troubleshooting | 36 |
| Specifications  | 37 |

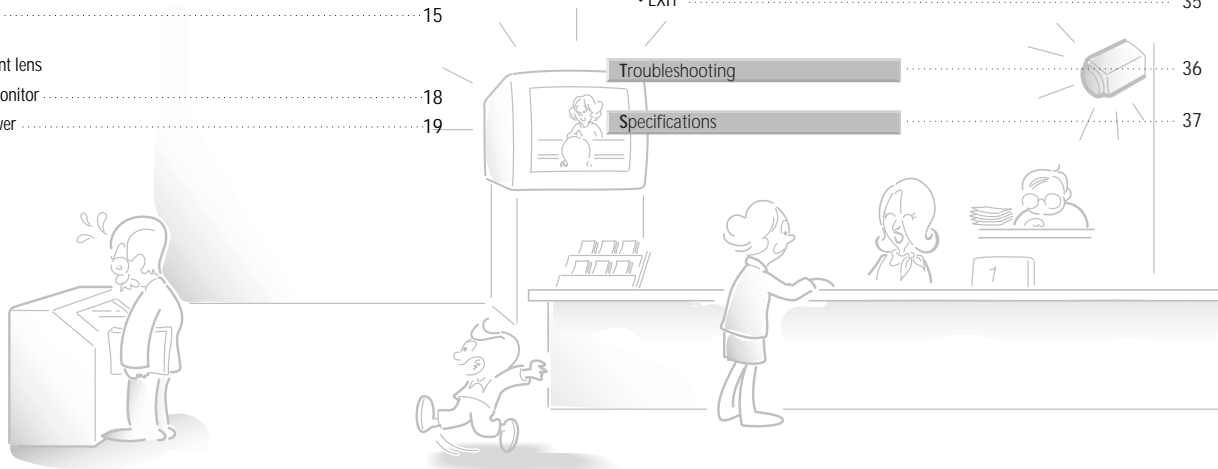

## Features

### Horizontal Resolution 530 TV Lines

Clear image quality has been achieved by employing a CCD with 410,000 pixels (NTSC), 470,000 pixels (PAL), which provides a horizontal resolution of 530 TV lines.

### Electronic DAY & NIGHT

This camera has a function that electronically selects the mode that is appropriate for daytime or night-time conditions. The COLOR mode operates in daytime conditions to provide optimum colors, and BW mode operates in night-time conditions to enhance the definition of the image.

### Electronic IRIS

The electronic IRIS function enables continuous automatic control of the shutter between 1/60(1/50)-1/120,000 seconds.

### PRIVACY Function

The PRIVACY function conceals the areas you do not wish to appear on the screen.

### VIDEO/DC Drive Lens

The video drive lens and the DC drive lens can be selected by the touch of a switch.

### High Sensitivity

The built-in high sensitivity COLOR CCD enables a clear image even in 0.3Lux or lower illumination.

### SSNR (Samsung Super Noise Reduction)

By using built-in SSNR function manufactured by SAMSUNG TECHWIN, the amount of low illuminance noise has been significantly reduced, and the signal-to-noise ratio (S/N) as well as horizontal resolution have been improved, resulting in a clear and sharp image display even in the dark.

### Controlled by OSD Menu

The camera can be controlled by selecting text displayed on the monitor screen.

### Additional Functions

SENS-UP, MOTION DETECTION, MIRROR, SHARPNESS and SYNC(INT/LL) functions are also available.

## Warning

### The camera needs periodic maintenance.

Contact an authorized technician for maintenance.

### Stop using your camera when you find a malfunction.

If you use your camera around smoke or unusual heat for a long time, fire may be caused.

### Do not install the camera on a surface that can not support it.

Unless the surface is suitable, it could cause falling or other hazards.

### Do not handle the camera with wet hands.

It could cause an electric shock.

### Do not disassemble the camera.

It may result in fire, electric shock or other hazards.

### Do not use the camera close to a gas or oil leak.

It may result in fire or other hazards.

## Precautions

**Do not install the camera in extreme temperature conditions.**



Only use the camera under conditions where temperatures are between  $-10^{\circ}\text{C}$  and  $+50^{\circ}\text{C}$ . Be especially careful to provide ventilation when operating under high temperatures.

**Do not install the camera under unstable lighting conditions.**

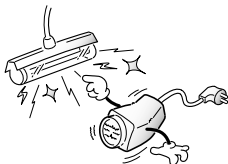

Severe lighting change or flicker can cause the camera to work improperly.

**Do not install or use the camera in an environment where the humidity is high.**



It can cause the image quality to be poor.

**Do not touch the front lens of the camera.**



It is one of the most important parts of the camera. Be careful not to be stained by fingerprint.

**Do not drop the camera or subject them to physical shocks.**



It can cause malfunctions to occur.

**Do not expose the camera to rain or spill beverage on it.**



If it gets wet, wipe it dry immediately. Liquids can contain minerals that corrode the electronic components.

**Never keep the camera face to strong light directly.**

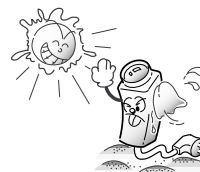

It can damage the CCD.

**Do not expose the camera to radioactivity.**



If it is exposed to radioactivity, For heated CCD, it will be out of order.

### Note

- If the camera is exposed to spotlight or object reflecting strong light, smear or blooming may occur.
- Please check that the power satisfies the normal specification before connecting the camera.

## Components

### 1. HIGH RESOLUTION DAY & NIGHT COLOR CAMERA

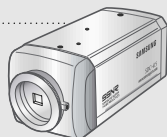

### 2. Auto iris lens connection plug

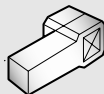

### 3. C-Mount adaptor



### 4. Instruction manual



## Names and Functions of Parts

### Front

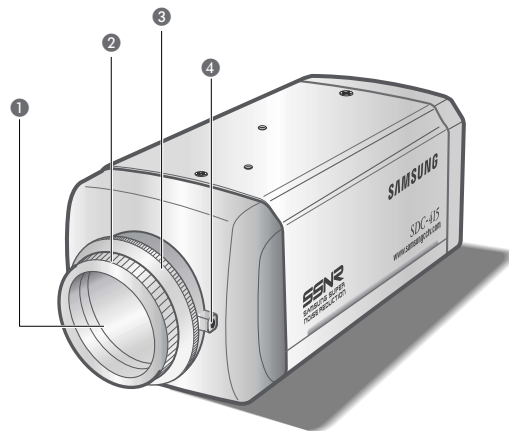

#### ① CCD protection cap

Please cover the CCD SENSOR when not using it.

#### ② C-Mount lens adaptor

Please attach the C-Mount lens here.

#### ③ CS-Mount lens adaptor

Please remove the C-MOUNT lens adaptor and then attach it.

#### ④ Back Focus clamp screw

Please loosen the clamp screw with a screwdriver before adjusting the Back Focal length.

## Names and Functions of Parts

### Side

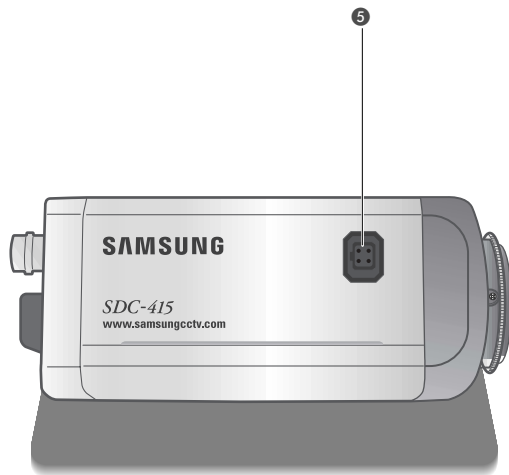

#### 5 Auto iris lens connector

This is the connection terminal for the auto iris lens.

### Bottom

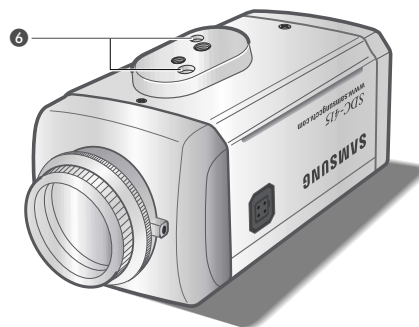

#### 6 Mounting bracket screw hole

Please use the screw hole when fixing the camera onto the mounting bracket. Please use the clamp screw as specified below.

※The mounting bracket can be separated and attached to the top of the camera.

In this instance please do not tighten the screw to a depth of more than 4mm, otherwise serious damage can occur to the inside of the camera.

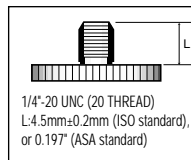
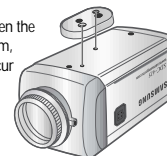

#### Note

- This camera package does not include the mounting bracket. Please refer to the user's manual for installation of the mounting bracket.

## Names and Functions of Parts

### Back

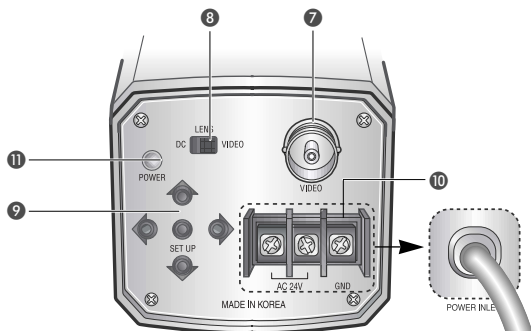

\*High Voltage Type(SDC-415PH)

#### 7 Video output terminal

Sends video signal and connects to the video input terminal of the monitor.

#### 8 Auto iris lens selection switch

Please change the mode to DC or VIDEO depending on the type of auto iris lens being used.

#### 9 Setting button

- **SETUP button** : Used for the menu display. This button can be used to confirm settings after changing the value of the selected function or current conditions.
- **UP & DOWN buttons** : Used for selecting items by moving the cursor up or down on the menu screen.
- **LEFT & RIGHT buttons** : Used when changing item values, by moving the cursor to the left or right on the menu screen.

#### 10 Power input terminal

Connects to the power appropriate to each model.

#### 11 Power lamp

Lights up when the correct power is supplied to the camera.

## Installation

### ■ Lens

Lenses are sold separately. Lenses such as an auto iris lens, CS-Mount lens and C-Mount lens can be used.



### Note

- Please keep the lens clean.
- Any foreign objects and fingermarks on the lens can cause inferior image quality in low light level conditions.

### When using an auto iris lens

1. Please peel off about 8mm of the outer skin of the auto iris lens cable.

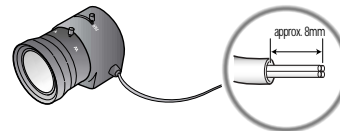

2. Please peel off about 2mm of the outer skin of the insulated conductor inside the lens cable.

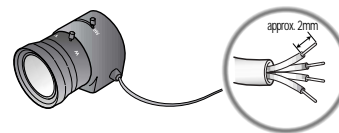



# Installation

3. Please remove the cover of the auto iris lens connection plug and solder the lens cable to the connector pin in the plug.

| Pin No.  | LENS     |                      |
|----------|----------|----------------------|
|          | DC       | VEDIO                |
| No.1 Pin | Damping- | Red (power)          |
| No.2 Pin | Damping+ | NC                   |
| No.3 Pin | Drive+   | White (video signal) |
| No.4 Pin | Drive-   | Black (GND)          |

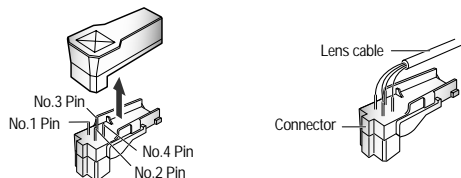

4. Please replace the auto iris lens connection plug cover and take off the CCD protection cap, and then attach the auto iris lens to the camera by screwing it in clockwise.

5. Please insert the connection plug that is connected to the auto iris lens cable into the auto lens connector, which is located on the side of the camera.

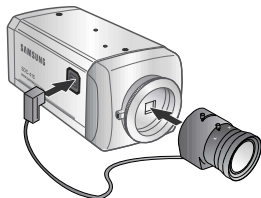

6. Please set the lens selection switch, located on the side of the camera, to DC or VIDEO depending on the type of auto iris lens which is being used.



## When using a C-Mount lens

Please take off the CCD protection cap and attach the C-Mount lens to the camera by screwing it in clockwise.

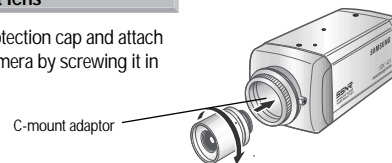

## When using a CS-Mount lens

1. Please take off the CCD protection cap and C-mount adaptor.

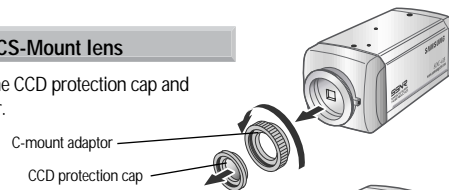

2. Please attach the CS-Mount lens to the camera by screwing it in clockwise.

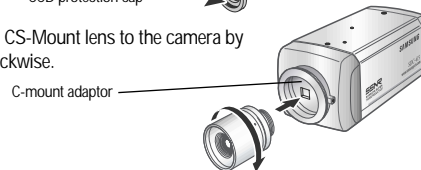

## Note

- Please use the specified lens connection parts as shown in the picture below. The use of the wrong sized parts of the wrong size may cause damage to the inside of the camera or result in poor fitting.
- Use of a lens which is too heavy affects the balance of the camera and may cause a malfunction. Please use a lens that weighs less than 450g.
- Please select Av mode if possible when adjusting the automatic light control (ALC) of an auto lens. Use of PK mode may cause hunting.

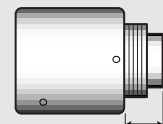

C-mount lens : 10 mm or less  
CS-mount lens : 5 mm or less

# Installation

## ■ Connecting to a monitor

Please connect the video output terminal located on the back of the camera to the monitor.

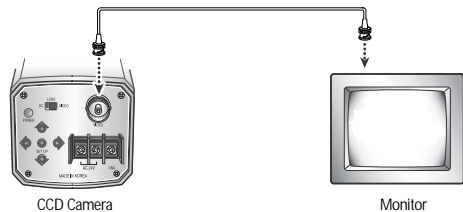

- The connection method varies depending on the type of monitor and accessories. Please refer to the user's manual for each instrument.
- Please turn off the power when connecting.
- Please select Hi-Z on the 75Ω/Hi-Z switch for the intermediate video TV set and select 75Ω for the Intermediate device as shown in the picture below.

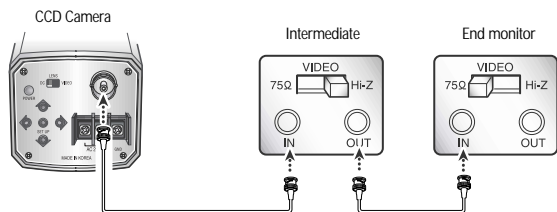

## ■ Connecting to power

Each model has a different power input specification. Please check the model type and standard power requirement before connecting to power.

### AC Power Type (AC 24V, 300mA)

Use AC24V, 300mA adaptor  
For SDC-415NA/SDC-415PA.

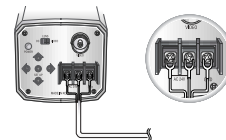

### DC Power Type (DC 12V, 500mA)

Use DC12V, 500mA adaptor  
For SDC-415ND/SDC-415PD.

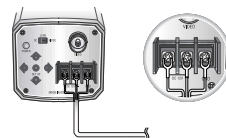

### High Voltage Type (AC230V, 50/60HZ)

Use AC230V, 50/60Hz power source  
For SDC-415PH.



When the resistance value of copper wire is at [20°C(68°F)]

| Copper wire size(AWG) | #24(0.22mm <sup>2</sup> ) | #22(0.33mm <sup>2</sup> ) | #20(0.52mm <sup>2</sup> ) | #18(0.83mm <sup>2</sup> ) |
|-----------------------|---------------------------|---------------------------|---------------------------|---------------------------|
| Resistance value(Ω/m) | 0.078                     | 0.050                     | 0.030                     | 0.018                     |
| Voltage drop(V/m)     | 0.028                     | 0.018                     | 0.011                     | 0.006                     |

- As shown in the table above, voltage decreases as the wire gets longer. Therefore use of an excessively long adaptor output line for connection to the camera may affect the performance of the camera.

※ Standard voltage for camera operation : DC 12V±10%

※ There may be some deviation in voltage drop depending on the type of wire and the manufacturer.

## Camera Operation

### ■ Menu

| SETUP menu                               |  |  |         |
|--|--|--|---------|
| LENS (selection)                         | •MANUAL  | •DC / VIDEO                                      |         |
| SHUTTER<br>(condition and speed control) | •ESC   | •MANUAL  | •FLK    |
| WHITE BALANCE control                    | •ATW   | •AWC   | •MANUAL |
| BACKLIGHT<br>(Backlight compensation)    | •OFF<br>•HIGH  | •LOW   | •MIDDLE |
| AGC (Auto Gain control)                  | •OFF<br>•HIGH  | •LOW   | •MIDDLE |
| SSNR<br>(Samsung super noise reduction)  | •OFF<br>•HIGH  | •LOW   | •MIDDLE |
| SENS-UP (Low illuminance)                | •OFF   | •AUTO  |         |
| SPECIAL                                  | •CAMERA ID<br>•SYNC<br>•PRIVACY<br>•SHARPNESS<br>•RETURN | •COLOR<br>•MOTION DETECTION<br>•MIRROR<br>•RESET |         |
| EXIT                                     |  |  |         |

### ■ Settings

Settings can be made using the 5 buttons located on the back of the camera.

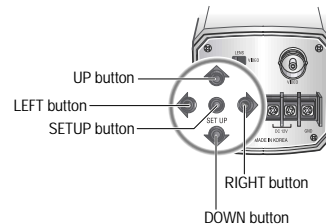

1. Please press the SETUP button
  - Settings can now be made. The SETUP menu is displayed on the monitor.

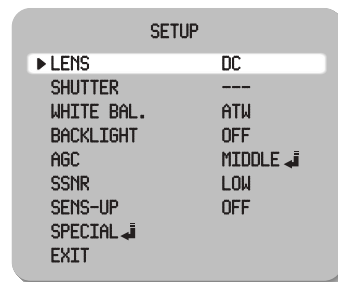

2. Please select any function you wish to activate by using the UP and DOWN buttons.
  - The arrow can be moved up or down by using the UP and DOWN buttons. Please position the arrow to point to the function you wish to operate.

## Camera Operation

Select any function you wish to operate by using the UP and DOWN buttons.

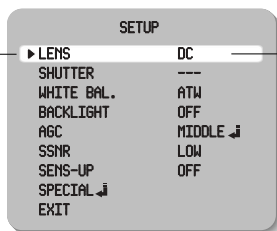

Modes can be changed using the LEFT and RIGHT buttons.

- Please press the LEFT or RIGHT button if you wish to change mode.
  - When the LEFT or RIGHT button is pressed, available values and modes are displayed in order. Please keep pressing the button until you get to the mode you wish to operate.
- Please select 'EXIT' and then press the SETUP button to finish the setting.

### Note

- If ↵ appears at the mode you wish to operate, it means that there is a sub-menu which can be selected by pressing the SETUP button.
- If --- appears at the mode item, it means that there is no mode available to be selected.

### LENS (selection)

This function is used to adjust the brightness of the screen.

- When the SETUP menu is displayed on the screen, please position the arrow to point to 'LENS' by using the UP and DOWN buttons.
- Please select the type of the lens you wish to use by pressing the LEFT or RIGHT button.

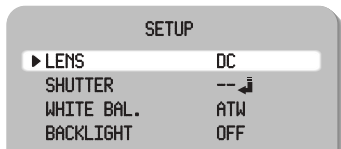

### DC/VIDEO : Auto iris lens selection

#### Note

- When using an auto iris lens, the setting of the auto iris lens selection switch, located on the back of the camera, must be on DC or VIDEO depending on the type of the lens which is being used. (Please refer to the picture on page 15)
- The brightness of the screen can be adjusted in DC mode. The brightness can be adjusted within the range of 1 ~ 70. The optimum level of brightness for the user can be achieved by adjustment.

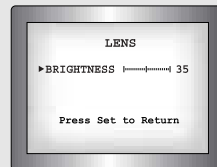

### MANUAL : Manual lens selection

- Please press the SETUP button if you wish to return to the previous menu.

## Camera Operation

### SHUTTER (condition and speed control)

Auto or manual control can be selected.

- When the SETUP menu is on the screen, please position the arrow to point to 'SHUTTER' by using the DOWN button.
- Please select the shutter mode by pressing the LEFT or RIGHT button.
  - FLK** : Please select 'FLK' mode when flickering occurs on the screen, due to an imbalance between illumination and frequency.  
NTSC Model: 1/100, PAL MODEL: 1/120
  - ESC** : Auto control of the shutter speed can be achieved. When ESC mode is on, the speed is controlled automatically according to the brightness of the screen.
  - MANUAL** : The shutter speed can be controlled manually.

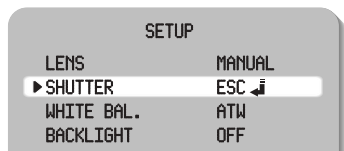

- Please select 'MANUAL' mode if you wish to adjust the shutter manually.
  - You can select speed from '1/60' to '1/120,000'sec (NTSC Models), '1/50' to '1/120,000'sec (PAL Models).
- Please press the SETUP button when all the settings are complete.

#### Note

- When selecting DC/VIDEO lens, the shutter speed is fixed at 1/60 (1/50).
- While using the internal synchronous system, if the shutter setting is on 'ESC' and the camera is directly facing a bright fluorescent light, the image on the screen can be adversely affected. Therefore please choose the installation location with care.
- When 'MANUAL' mode is on, the SENS UP function does not operate.

### WHITE BALANCE control

The screen color can be adjusted by using the WHITE BALANCE function.

- Please position the arrow to point to 'WHITE BAL' on the SETUP menu by using the UP and DOWN buttons.
- Please select the mode you wish to operate by pressing the LEFT or RIGHT button.

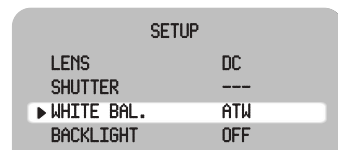

- Please select one of the 3 modes below.
  - ATW(Auto Tracking White Balance)** : This mode can be used within the color temperature range 1,800°K ~ 10,500°K (Ex. fluorescent light, outdoor, sodium vapor lamp or inside tunnels)
  - AWC(Auto White Balance Control)** : Please press the SETUP button while the camera is directed at a piece of white paper to obtain the optimum state under current illumination. If the environment including the light source is changed, you have to adjust the white balance again.
  - MANUAL** : The manual adjustment mode enables finer adjustment. Please select ATW or AWC first. Please change to manual adjustment mode and press the SETUP button. Please set the appropriate color temperature, and then increase or decrease the red and blue color values while monitoring the color changes on the object.

#### Note

- Under the following conditions the WHITE BALANCE function may not operate properly. In such cases, please select the AWC mode.
  - When the object's surroundings have a very high color temperature (Ex. a clear sky and sunset)
  - When the object's surroundings are dark
  - If the camera directly faces a fluorescent light or is installed in a place where there are considerable changes in illumination, the WHITE BALANCE function may become unstable.

## Camera Operation

### BACKLIGHT (Backlight Compensation)

When there is a strong backlight behind the object, clear images of the background as well as the object can still be obtained by using the BACKLIGHT function.

1. Please position the arrow to point to 'BACKLIGHT' on the SETUP menu by using the UP and DOWN buttons.
2. Please select the mode you wish to operate by pressing the LEFT or RIGHT button.

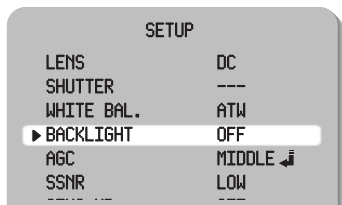

#### ⊙HIGH/MIDDLE/LOW

You can adjust the sensitivity of Backlight Compensation.

- ⊙OFF : BACKLIGHT function does not operate.



BACKLIGHT ON



BACKLIGHT OFF

### AGC (Auto Gain Control)

1. Please position the arrow to point to 'AGC' on the SETUP menu by using the UP and DOWN buttons.
2. Please select the mode you wish to operate by pressing the LEFT or RIGHT button. As the level of gain increases, the screen gets brighter and the level of noise also increases.
  - ⊙HIGH : The gain increases or decreases within the range of 6dB ~ 34dB.
  - ⊙MIDDLE : The gain increases or decreases within the range of 6dB ~ 30dB.
  - ⊙LOW : The gain increases or decreases within the range of 6dB ~ 18dB.
  - ⊙OFF : The gain is fixed at 6dB.

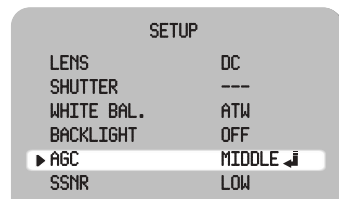

3. Please press the SETUP button.

The BRIGHTNESS can be adjusted within the range of 1-70.



4. Please press the SETUP button when all the settings are complete.

## Camera Operation

### SSNR (Samsung Super Noise reduction)

The background noise in the low light level decreases automatically as the level of gain changes.

1. Please position the arrow to point to 'SSNR' on the SETUP menu by using the UP and DOWN buttons.
2. Please select the mode you wish to operate by pressing the LEFT or RIGHT button.

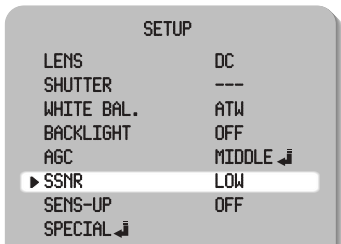

- OFF : There is no reduction in noise level.
- LOW : There is a small reduction in noise level with almost no ghost image.
- MIDDLE : The most effective mode. There is a sufficient reduction in noise levels without causing much ghost imaging.
- HIGH : The level of noise is reduced greatly, however there is an increase in ghost imaging.

#### Note

- When AGC is turned off, SSNR does not operate.

### SENS UP (Low illuminance)

SENS UP helps maintain a bright, clear screen image by automatically detecting changes in the level of light in low light level conditions.

1. Please position the arrow to point to 'SENS UP' on the SETUP menu by using the UP and DOWN buttons.
2. Please select the mode you wish to operate by pressing the LEFT or RIGHT button.
  - AUTO : Low light level auto mode
  - OFF : The function does not operate.

#### Note

- When SHUTTER is in the manual mode, SENS UP does not operate.
- When AGC is turned off, SENS UP does not operate.

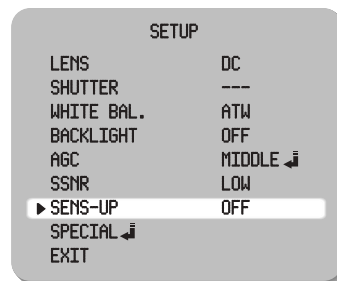

3. Please press the SETUP button when all the settings are complete.

#### Note

- The maximum storage magnification in low light level can be adjusted by pressing the SETUP button in 'AUTO' mode.(X2-X128)
- As the magnification increases, the screen gets brighter; moving object gets more afterimage.
- If storage magnification is increased while SENS UP is operating, it may cause noise, and spots may appear; however this is normal.

## Camera Operation

### SPECIAL

1. Please position the arrow to point to 'SPECIAL' on the SETUP menu by using the UP and DOWN buttons.
2. Please select the mode you wish to operate by pressing the UP or DOWN button.

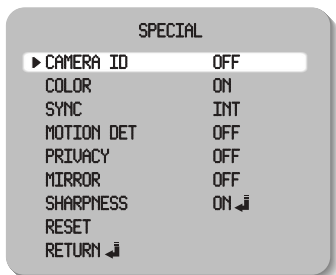

**CAMERA ID** : If the ID is input, the camera ID appears on the monitor.

- 1) Please position the arrow to point to 'CAMERA ID' by using the UP or DOWN button.
- 2) Please select 'ON' by pressing the LEFT or RIGHT button.

#### Note

- If 'OFF' is selected, the ID does not appear on the monitor even if it has been input.

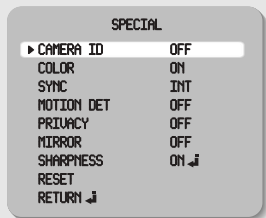

- 3) Please press the SETUP button.

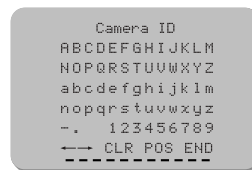

- 4) Up to 15 letters can be used for the ID.

- 1) Please move the cursor to the letter you wish to choose by using the UP and DOWN buttons.

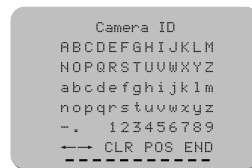

- 2) Select an ID from A,B-Y,Z, a,b-y,z, 0,1-8,9 by using the UP, DOWN, LEFT and RIGHT buttons.
- 3) Please lock in the letters by using the SETUP button.
  - When the letter is locked in, the cursor moves to the next space.
- 4) Please repeat the above to input the ID.

#### Note

- If the wrong name has been input.....  
If you press the SETUP button after moving the cursor to CLR, all the letters will be erased. If you want to correct a letter, please move the cursor to the arrow at the bottom left of the screen and press 'SET'.  
Please position the cursor above the letter you wish to correct, and then move the cursor onto the letter you wish to choose and press the SETUP button.



## Camera Operation

5) When a name has been chosen, please select a position for the name display.

- 1 Please move the cursor onto 'POS' and then press the SETUP button.

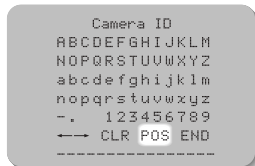

- 2 The name will appear at the top left hand corner.



- 3 Please find the position you wish to display the name by using the 4 directional buttons, and then press the SETUP button.



6) Please select 'END' and then press the SETUP button to complete ID input.

### ⊕ COLOR (Electronic DAY & NIGHT)

- AUTO : This camera has a function which electronically changes to the appropriate mode for daytime or night-time. The COLOR mode is operated for daytime, and it converts to BW mode for night-time.
- ON : The color mode is selected electronically.

### Note

- If AGC is OFF, you can't select AUTO mode.
- When an infrared light is used, there may be a problem with focusing and COLOR (DAY & NIGHT).

- ⊕ SYNC : Two SYNCHRONIZATION modes are available INTERNAL and EXTERNAL LINE-LOCK. In LINE-LOCK mode, it synchronizes the video signal between cameras without a synchronous generator. The line-lock synchronization is only used in the areas of 60Hz (NTSC Models) / 50Hz (PAL Models).
  - INT : Internal synchronization
  - LL : External line-lock synchronization
- If you choose 'LL', you can adjust the desired phase. Press the SET button.
- You can adjust the desired phase from 0 to 359.

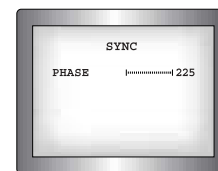

### Note

- When the power frequency is 50Hz, you can not use line-lock mode (NTSC Models).
- When the power frequency is 60Hz, you can not use the line-lock mode (PAL Models).
- 'Sync.' mode is fixed to 'INT' in DC 12V input power.

## Camera Operation

### ● MOTION DETECTION:

This product has a feature that allows you to observe movements of objects in 4 different areas on the screen, and the words 'MOTION DETECTED' appear on the screen when movement is detected; hence a single individual can conduct supervision efficiently. The camera detects an object's movement by sensing disparity of outline, and level of brightness and color.

- Please press the SETUP button.
  - OFF : MOTION DETECTION mode is cancelled.
  - ON : Any motion in the selected areas is observed.
- Please select the area you wish to observe from the 4 areas in AREA SEL mode.
- Please select ON mode for the chosen area.
- Please adjust the size of the area to be observed by using the UP, DOWN, LEFT or RIGHT button.

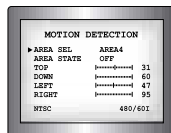

- Please press the SETUP button to save the changes and complete the setting.



### Note

- There is no MD output signal. MD is on screen display only words.

● PRIVACY : This mode conceals the areas you do not wish to appear on the screen.

- OFF : Cancels the PRIVACY mode. - ON : Operates the PRIVACY mode.
- Please press the SETUP button.



- Please select the area you do not wish to appear from the 4 areas in AREA SEL mode.
- Please select ON mode for the chosen area.
- Please adjust the size of the area to be concealed by using the UP, DOWN, LEFT or RIGHT button.

### ● MIRROR

- ON : Sets a horizontal image inversion.
- OFF : Cancels the inversion.

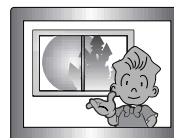

MIRROR ON

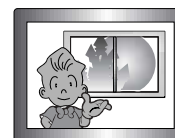

MIRROR OFF

● SHARPNESS : The outline of the video image becomes cleaner and more distinctive as the level of SHARPNESS increases. If the level goes up excessively, however, it may affect the video image and generate noise.

- Please press the SETUP button.



- The available range of level is 0 ~ 31.

- RESET : Returns to the level which was set by the manufacturer for shipment.
- RETURN : Returns to the SETUP menu.

### EXIT

Saves all the setting menus and then exits.

## Troubleshooting

If there are problems in operation, please refer to the items below. If the problem persists, please contact the agent you purchased this product from.

| Problems   | Troubleshooting  |
|--|--|
| <b>Nothing appears on the screen.</b>  | <ul style="list-style-type: none"> <li>• Please check the power connection.</li> <li>• Please check the video signal line connection.</li> <li>• Please check and make sure that the auto lens switch is set to DC (VIDEO) when using a DC (VIDEO) lens.</li> <li>• Please check the Brightness of Auto Iris lens.</li> </ul>  |
| <b>The video image is not clear.</b>   | <ul style="list-style-type: none"> <li>• Please check if the lens is clean. Please clean the lens with a clean cloth or brush.</li> <li>• Please adjust the contrast feature of the monitor.</li> <li>• Please make sure that the screen is not exposed directly to a bright light. Please move the camera if necessary.</li> <li>• Please readjust the back focus of the camera.</li> </ul> |
| <b>The screen is dark.</b>   | <ul style="list-style-type: none"> <li>• Please adjust the contrast feature of the monitor.</li> <li>• If you have an intermediate device, set the 75Ω/Hi-z properly, and check the terminals. (refer to page 18)</li> <li>• Please check if an auto iris lens is being used and adjust the brightness level.</li> </ul>   |
| <b>There is a problem with the camera operation. The camera surface is too hot and black stripes appear on the screen.</b> | <ul style="list-style-type: none"> <li>• Please check if an appropriate power source to the camera complies with the manufacturer's standard requirement, or if the voltage keeps changing.</li> </ul>   |

| Problems   | Troubleshooting   |
|--|---|
| <b>The MOTION DETECTION function is not working.</b> | <ul style="list-style-type: none"> <li>• Please check if 'MOTION DETECTION' mode is turned on.</li> <li>• Please check if the MD LEVEL is too low.</li> <li>• Please check the setting of the MD AREA.</li> </ul>   |
| <b>Colors are not quite right.</b>                   | <ul style="list-style-type: none"> <li>• Please check the 'WHITE BAL' setting. (Please refer to page 25)</li> </ul>   |
| <b>The screen is flickering.</b>                     | <ul style="list-style-type: none"> <li>• Please check if the camera is facing directly into sunlight or fluorescent light.</li> <li>• Please check if an auto iris lens is being used.</li> <li>• Please check the connection of the lens connector cable.</li> </ul> |
| <b>L/L mode isn't able to be selected.</b>           | <ul style="list-style-type: none"> <li>• Have you connected your camera to DC power source? Connect it to AC power source.</li> </ul>   |
| <b>L/L mode is not available.</b>                    | <ul style="list-style-type: none"> <li>• Please check the frequency of power supply (60Hz for NTSC, 50Hz for PAL).</li> </ul>   |
| <b>COLOR (DAY &amp; NIGHT) mode is not working.</b>  | <ul style="list-style-type: none"> <li>• Please check if the AGC menu is set to the OFF position.</li> </ul>  |
| <b>SENS-UP function is not working.</b>              | <ul style="list-style-type: none"> <li>• Please check if the AGC menu is set to the OFF position.</li> <li>• Please check if the SHUTTER menu is set to MANUAL mode.</li> <li>• Please check the limit of Sens-UP AUTO mode.</li> </ul>                               |

# Specifications

| Item                           |                  | SDC-415NA                                  | SDC-415ND          | SDC-415PA                               | SDC-415PH               | SDC-415PD          |
|--------------------------------|------------------|--|--------------------|---|-------------------------|--------------------|
| Power Source                   |                  | AC24V, 60Hz<br>3.5W(Max)                   | DC12V<br>2.5W(Max) | AC24V, 50Hz<br>3.5W(Max)                | AC240V, 50Hz<br>4W(Max) | DC12V<br>2.5W(Max) |
| C<br>C<br>D                    | Total Pixels     | 811(H) x 508(V)                            |                    | 795(H) x 596(V)                         |                         |                    |
|                                | Effective Pixels | 768(H) x 494(V)                            |                    | 752(H) x 582(V)                         |                         |                    |
| Size                           |                  | 1/3" Super HAD color CCD                   |                    |   |                         |                    |
| S<br>y<br>n<br>c               | Scanning System  | 2:1 Interlace                              |                    |   |                         |                    |
|                                | Synchronization  | INT/LL Selectable<br>0-359°(Adjustable)    | INT                | INT/LL Selectable<br>0-359°(Adjustable) | INT                     |                    |
|                                | Frequency        | Horizontal:15.734 KHz Vertical:59.94Hz     |                    | Horizontal: 15.625 KHz Vertical : 50Hz  |                         |                    |
|                                | Resolution       | More than 530 TV Lines                     |                    |   |                         |                    |
| Video Output                   |                  | 1.0Vp-p/75Ω                                |                    | 1.0Vp-p/75Ω                             |                         |                    |
| S/N (Y signal)                 |                  | 50dB (AGC OFF, Weight ON)                  |                    |   |                         |                    |
| Min. Illumination              |                  | 0.3Lux/F1.2, 0.002Lux/F1.2(Sens-UP X128)   |                    |   |                         |                    |
| COLOR (DAY & NIGHT)            |                  | ON/AUTO(Electronically)                    |                    |   |                         |                    |
| Gain Control                   |                  | OFF / LOW / MIDDLE / HIGH                  |                    |   |                         |                    |
| White Balance                  |                  | ATW/AWC/MANUAL(1,800°K-10,500°K)           |                    |   |                         |                    |
| Backlight Compensation         |                  | OFF/LOW/MIDDLE/HIGH                        |                    |   |                         |                    |
| Electronic shutter speed       |                  | AUTO/MANUAL(1/60-1/120,000 sec)            |                    | AUTO/MANUAL(1/50-1/120,000 sec)         |                         |                    |
| Sens-Up                        |                  | OFF/AUTO(X2-X128)                          |                    |   |                         |                    |
| O.S.D                          |                  | Built-in                                   |                    |   |                         |                    |
| Motion Detection               |                  | ON / OFF (4 Programmable Zone)             |                    |   |                         |                    |
| SSNR                           |                  | OFF / LOW / MIDDLE / HIGH(Noise Reduction) |                    |   |                         |                    |
| MIRROR                         |                  | Built-in(Horizontal Image Inversion)       |                    |   |                         |                    |
| Privacy Function               |                  | ON / OFF (4 Programmable Zone)             |                    |   |                         |                    |
| IRIS Control                   |                  | DC / VIDEO                                 |                    |   |                         |                    |
| Lens Mount                     |                  | C/CS Mount (Changeable)                    |                    |   |                         |                    |
| Dimension                      |                  | 58(W) x 52(H) x 121(D)mm                   |                    |   |                         |                    |
| Operating temperature/Humidity |                  | -10°C ~ +50°C [14°F-122°F] / 20-90% RH     |                    |   |                         |                    |
| Weight                         |                  | 340g                                       | 310g               | 340g                                    | 510g                    | 310g               |

# DECLARATION OF CONFORMITY

Application of Council Directive(s) 89 /336 /EEC

Manufacturer's Name SAMSUNG TECHWIN CO., LTD

Manufacturer's Address SAMSUNG TECHWIN CO., LTD  
42, SUNGJU-DONG CHANGWON-CITY,  
KYUNGNAM, KOREA, 641-120

European Representative Name \_\_\_\_\_

European Representative Address \_\_\_\_\_

Equipment Type/Environment CCTV Camera

Model Name SDC-415PA, SDC-415PD  
SDC-415PH

Beginning Serial NO. S5800001

Year of Manufacture 2005. 10. 1

Conformance to EN 50081-1:1992  
EMC-Directive 89/336 EEC and 92/31/EEC  
EN 50130-4:1996

We, the undersigned, hereby declare that the equipment specified above conforms to the above Directive(s).

Manufacturer SAMSUNG TECHWIN CO., LTD Legal Representative in Europe \_\_\_\_\_

Signature Young Taek, SON Signature \_\_\_\_\_

Full Name YOUNG TAEK SON Full Name \_\_\_\_\_

Position QUALITY CONTROL MANAGER Position \_\_\_\_\_

Place CHANGWON, KOREA Place \_\_\_\_\_

Date 2005. 10. 1 Date \_\_\_\_\_

MEMO

MEMO