

user's manual

eng



NV-DVR1104/CD
NV-DVR1108/CD
NV-DVR1116/CD

NOvUS[®]

INFORMATIONS

EMC (89/336/EEC) and LVD (73/23/EEC) Directives

CE Marking

 Our products are manufactured to comply with requirements of following directives and national regulations implementing the directives:

- Electromagnetic compatibility EMC 89/336/EEC with further amendments.
- Low voltage LVD 73/23/EEC with further amendment. The Directive applies to electrical equipment designed for use with a voltage rating of between 50VAC and 1000VAC as well as 75VDC and 1500VDC.

WEEE Directive 2002/96/EC



Information on Disposal for Users of Waste Electrical and Electronic Equipment

This appliance is marked according to the European Directive on Waste Electrical and Electronic Equipment (2002/96/EC) and further amendments. By ensuring this product is disposed of correctly, you will help to prevent potential negative consequences for the environment and human health, which could otherwise be caused by inappropriate waste handling of this product.

The symbol on the product, or the documents accompanying the product, indicates that this appliance may not be treated as household waste. It shall be handed over to the applicable collection point for the waste electrical and electronic equipment for recycling purpose.

For more information about recycling of this product, please contact your local authorities, your household waste disposal service or the shop where you purchased the product.



RoHS Directive 2002/95/EC

Concerning for human health protection and friendly environment, we assure that our products falling under RoHS Directive regulations, regarding the restriction of the use of hazardous substances in electrical and electronic equipment, were designed and manufactured in compliance with mentioned regulation. Simultaneously, we claim that our products were tested and do not contain hazardous substances exceeding limits which could have negative impact on human health or natural environment.

Information

The device, as a part of professional CCTV system used for surveillance and control, is not designed for self installation in households by individuals without technical knowledge.

The manufacturer is not responsible for defects and damages resulted from improper or inconsistent with user's manual installation of the device in the system.

WARNINGS AND PRECAUTIONS

WARNING!

READ, KEEP AND FOLLOW THESE INSTRUCTIONS. ALL THE SAFETY AND OPERATING INSTRUCTIONS SHOULD BE READ BEFORE THE PRODUCT IS OPERATED.



WARNING:

TO REDUCE THE RISK OF FIRE OR ELECTRIC SHOCK DO NOT EXPOSE THIS UNIT TO RAIN OR MOISTURE IF THIS UNIT IS DESIGNED FOR INDOOR USE ONLY.

WARNING!

USER IS NOT ALLOWED TO DISASSEMBLE THE CASING IF THERE ARE NO USER-SERVICEABLE PARTS INSIDE THIS UNIT. ONLY AUTHORIZED SERVICE PERSONNEL MAY OPEN THE UNIT
INSTALLATION AND SERVICING SHOULD ONLY BE DONE BY QUALIFIED SERVICE PERSONNEL AND CONFORM TO ALL LOCAL REGULATIONS

WARNING!

DIGITAL MULTIPLEXER IS SENSITIVE TO ELECTROSTATIC DISCHARGES THEREFORE IT SHOULD BE USED IN ACCORDANCE WITH OPERATING AND MAINTENANCE RULES FOR DEVICES BASED ON CMOS/MOSFET TECHNOLOGY.

INFORMATION

Data included in the following user's manual is up to date at the time of printing. Novus Security Sp z o.o. holds exclusive rights to modify this manual. The producer reserves the rights for device specification modification and change in the design without prior notice.

WARNINGS AND PRECAUTIONS

1. Installation and servicing of the Multiplexer should only be carried out by qualified service personnel and conform to all local regulations.
2. Do not place the Multiplexer in areas where ventilation openings might be blocked or covered.
3. There are no user-serviceable parts inside this unit. Only authorized service personnel may open the unit. The equipment should be protected from mechanical damage and kept clean at all times.
4. Protect this device from being exposed to dust and moisture. In the event of the Multiplexer coming into direct contact with water unplug the device immediately and contact qualified service personnel. Dusty (soiled/dirty) equipment may be the cause of fire and / or electrical shock.
5. Unplug the unit from the outlet before cleaning. This device can be cleaned only with a clean damp cloth. Try to avoid using chemically active liquid cleaners or aerosol. In the event of strong dirt it is allowed to use gentle cleaning lotion.
6. Power supply wires as well as signal wires should be fixed in the way that there is no risk of mechanical damage, Please take extra caution not to overload sockets and extension cords to prevent from the risk of fire.
7. In order to prevent the unit from damage, video channel and signal wires should be equipped with appropriate surge protection device conforming to European Union standards. We also advice utilizing video and data transmission protection.
8. It is not allowed to operate this device in conditions not complying with exploitation requirements in the range of power supply, relative air humidity or air temperature..
9. Metal objects cannot be put inside the device. It can cause major malfunction and/or damage the unit. In the event of the above, user should contact service immediately for further assistance.

eng

TABLE OF CONTENTS

1. FOREWORD INFORMATION	6
1.1 Main characteristics	6
1.2 Technical specification	7
2. DEVICE POWER UP	9
2.1 Preparing the equipment for operation.....	10
2.2 Electric connectors of back panel.....	12
2.3 External Devices Connection.....	13
2.4 HDD Installation.....	13
2.4.1 Swappable bay HDD installation	13
2.4.2 Internal HDD installation (inside the Multiplexer).....	13
2.5 Device power on and power off	14
3. FRONT PANEL DESCRIPTION	15
4. DEVICE MENU	17
4.1 System setup	18
4.2 Camera setup.....	21
4.3 Motion detection.....	22
4.4 Recording.....	24
4.5 Alarm setup.....	26
4.6 Event List.....	28
4.7 HDD Management.....	29
4.8 Network setup	31
4.9 Firmware update	32
4.10 CD/DVD backup	33
4.11 Default setup	33
5. RECORDING	34
5.1 Manual recording	35
5.2 Schedule recording.....	36
6. PLAYBACK	38
6.1 Play time search	38
6.2 Event list search	40
7. RECORDED DATA BACKUP	41
7.1 Flash memory backup.....	41
7.2 CD backup.....	42
8. ALARM INPUTS AND OUTPUTS CONNECTIONS FOR EXTERNAL DEVICES	44
9. SPEED DOME CAMERAS - CONNECTION AND CONTROL (PTZ)	46
9.1 Novus Speed Dome Camera Connection	46
9.2 Camera Control.....	48
10. IR REMOTE CONTROL	49
11. KEYBOARD CONTROL	50
12. NETWORK CONNECTION	51
12.1 Computer hardware requirements	51
12.2 Initiating connection.....	52
12.3 User Interface view	53
12.4 Display settings.....	54
12.4.1 Saving images in "live" mode.....	55
12.4.2 PTZ camera control in "live" mode.....	56
12.5 Recorded data search.....	57
12.5.1 Saving images while playback mode	59
12.6 Software settings.....	60
12.6.1 Software language and time server settings.....	60
12.6.2 User password and accounts.....	60
12.6.3 NC Viewer download	60
12.6.4 IP Setting	60
12.6.5 FTP & e-Mail.....	61
13. BACKUP PLAYBACK	62
13.1 View of NC Viewer software window.....	62
13.2 Flash memory backup playback	63
13.3 Flash memory backup converting to JPEG or AVI format.....	64
13.4 Flash memory backup printing.....	66
13.5 CD backup playback.....	67
13.6 CD backup converting to JPEG or AVI format	67
13.7 CD backup printing	67
13.8 Playback from HDD withdrawn directly from multiplexer	67

FOREWORD INFORMATION

1. FOREWORD INFORMATION

1.1 Main characteristics

- ✍ Operating mode triplex (simultaneous recording, playback and networking);
- ✍ Operating system based on Linux system;
- ✍ The possibility of installing two HDDs 3.5" IDE, one of them placed in swappable bay;
- ✍ Real-time display;
- ✍ Adjustable recording speed up to 100 fps;
- ✍ M-JPEG compression algorithm with various image quality settings;
- ✍ Recording resolution:
 - 360 x 288,
 - 720 x 288
- ✍ Schedule recording individually adjustable for each day with selection of mode and recording speed;
- ✍ Alarm recording function;
- ✍ Motion detection with defined active areas;
- ✍ 1-channel audio recording;
- ✍ Immediate access to any recorded data;
- ✍ PTZ camera control using front panel, remote control and network applet;
- ✍ The possibility of remote control of NOVUS® compact camera with RS-485 standard;
- ✍ Protocols: Novus-C, Novus-C1, Novus-C2, Novus-D1, Pelco-D;
- ✍ Fully-compatible with system keyboards series: NV-KBD60 and NV-KBD30;
- ✍ Files backup available methods: through network, USB port and using CD-RW recorder;
- ✍ Build-in CD-RW recorder;
- ✍ Network connection for live monitoring, playback recorded data, alarm event e-mail notification and backup event files on FTP;
- ✍ User friendly multi-lingual OSD;
- ✍ Multi-level password protection;
- ✍ Covered camera function;
- ✍ Remote control by means IR controller (included) or system keyboard;

TECHNICAL SPECIFICATION

1.2. Technical Specifications

	NV-DVR1104/CD
Operation Mode	Triplex (simultaneous: recording, playback, networking)
Video Input	4 x BNC loop-through, 1Vp-p/75 Ohm
Video Output	1 x BNC Main Monitor output (BNC, 1Vp-p/75 Ohm)
Alarm Input	4
Audio Input	1 x RCA
Alarm Output	1 relay alarm output
Compression algorithm	MJPEG
Recording Resolution	720 x 288, 360x288
Recording Speed	up to 50 fps (720x288) or up to 100 fps (360x288)
Recording mode	Continuous, Event (Alarm, Motion detection)
Schedule recording	recording mode selection (continuous, event, no recording) adjustable for each hour of a day
Display Speed	Live display, 25 fps for channel (up to 200 fps for 4 video inputs)
Display Screen	Full screen, 4;
Recorded data search	By date/time or events ;
Motion detection	adjustable zone's size and sensitivity (12x16 grid)
Event log	up to 2000 per HDD
Video loss detection	Yes
HDD	up to 2 HDD's (up to 400GB each), one in HDD swappable bay
Backup	through the network, through USB port, on USB Flash Memory, using built-in CD-RW recorder, on PC using NC Viewer software
External ports	1 x RJ-45 - LAN; 1 x RS-485 - for PTZ camera control
PTZ control	directly from the device, through the network
PTZ protocols	Novus-C, Novus-C1, Novus-C2, Pelco-D
Device control	front panel buttons, system keyboard, network
Menu	multilingual OSD
Password authorization	one password
Auto System Recovery	hardware WATCHDOG function
Power Supply	230 VAC
Power consumption	approx. 16 VA w/o HDD, approx. 40VA with 1 HDD, approx. 50 VA with 2 HDD's
Weight	7 kg
Operating temperature	0°C~ +40°C
Operating relative humidity	0%~80% (without condensation)

eng

TECHNICAL SPECIFICATION

	NV-DVR1108/CD	NV-DVR1116/CD
Operation Mode	Triplex (simultaneous: recording, playback, networking)	
Video Input	8 x BNC loop-through, 1Vp-p/75 Ohm	16 x BNC loop-through, 1Vp-p/75 Ohm
Video Output	1 x BNC Main Monitor output (BNC, 1Vp-p/75 Ohm), 1 x S-Video Main Monitor output, 1 x BNC Spot Monitor output (BNC, 1Vp-p/75 Ohm),	
Alarm Input	8	16
Audio Input	1 x RCA	
Alarm Output	1 relay alarm output	
Compression algorithm	MJPEG;	
Recording Resolution	720 x 288, 360x288	
Recording Speed	up to 50 fps (720x576) or up to 100 fps (360x288)	
Recording mode	Continuous, Event (Alarm, Motion detection)	
Schedule recording	recording mode selection (continuous, event, no recording) adjustable for each hour of a day	
Display Speed	live display, 25 fps for channel (up 200 fps for 8 video inputs)	live display, 25 fps for channel (do 400 fps for 16 video inputs)
Display Screen	Full screen, 4,8, sequence	Full screen, 4,9,13,16, sequence
Recorded data search	By date/time or events	
Motion detection	adjustable zone's size and sensitivity (12x16 grid)	
Event log	up to 2000 per HDD	
Video loss detection	Yes	
HDD	up to 2 HDD's (up to 400GB each), one in HDD swappable bay	
Backup	through the network, through USB port, on USB Flash Memory, using built-in CD-RW recorder, on PC using NC Viewer software	
External ports	1 x RJ-45 - LAN; 1 x RS-485 - for PTZ camera control	
PTZ control	directly from the device, through the network	
PTZ protocols	Novus-C, Novus-C1, Novus-C2, Pelco-D;	
Device control	front panel buttons, system keyboard, network	
Menu	multilingual OSD	
Password authorization	one password	
Auto System Recovery	hardware WATCHDOG function	
Power Supply	230 VAC	
Power consumption	approx. 16 VA w/o HDD, approx. 40VA with 1 HDD, approx. 50 VA with 2 HDD's	
Weight	7 kg	
Operating temperature	0°C~ +40°C;	
Operating relative humidity	0%~80~(without condensation)	

DEVICE POWER UP

2. DEVICE POWER UP

2.1 Preparing equipment for operation

Please take extra caution when unpacking the device.

Please ensure that following items are included in the package:



Digital Multiplexer NV-DVR1104/CD, NV-DVR1108/CD or NV-DVR1116/CD



Net cross-over cable
for Multiplexer-PC connection



HDD Swappable Bay
lock-keys



Power Supply
Cord



Remote controller

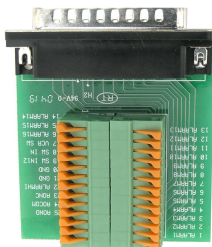

Alarm input terminal

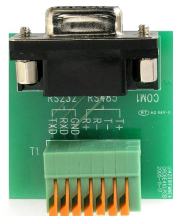

RS-485 terminal
(NV-DVR1108/CD
or NV-DVR1116/CD only)



CD containing manual and
software



User's Manual

If the equipment has been damaged during transport, the contents of package should be packed back to the original box. Contact the supplier for further assistance.

WARNING !

It is not allowed to power on the equipment directly after it has been brought from a place of low temperature. If the device has been brought from the area of lower temperature the user should wait until the equipment warms up slowly and reaches the room temperature.

Condensation of moisturized air may cause short circuit and damage the device.

DEVICE POWER UP

2.2 Electric connectors on back panel of the multiplexers.

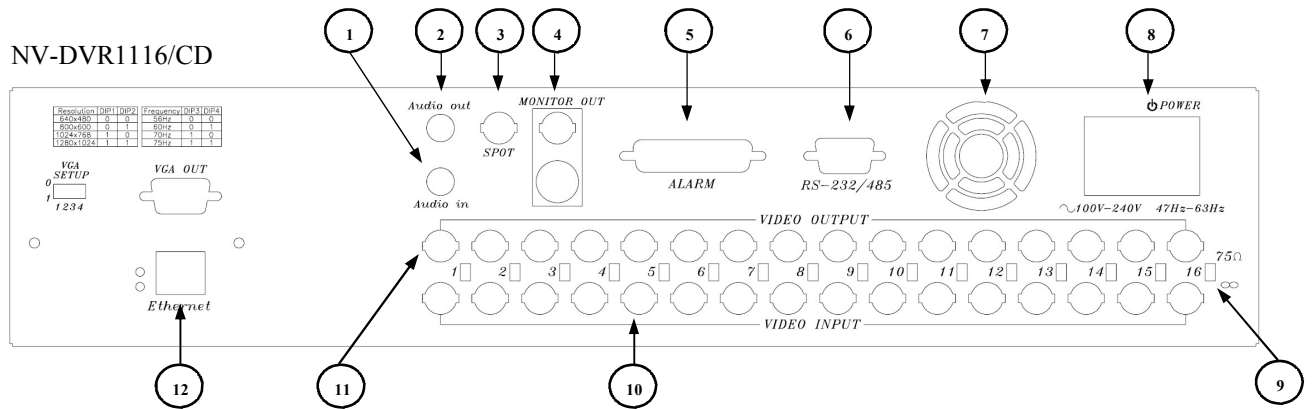
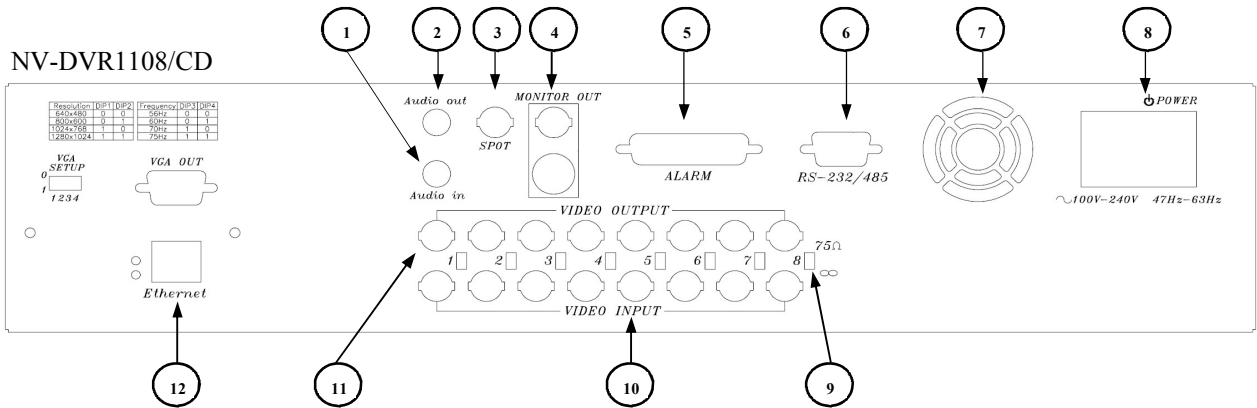

1. **Audio in:** 1 x RCA audio recording input;
2. **Audio out :** RCA audio output;
3. **SPOT:** video output for spot monitor connection, only full screen display available;
4. **MONITOR OUT:** main monitor connection (1 x BNC and 1 x S-Video connectors available); the possibility of selection from various display modes
5. **ALARM:** alarm inputs, alarm outputs;
6. **RS-232/485:** D-Sub 9 PIN connector, for device remote control and PTZ camera control;
7. cooling fan (do not cover!);
8. **POWER ~90~260V :** Power supply socket;
9. **75Ω / ∞:** video inputs termination switch;
10. **VIDEO INPUT:** video inputs for camera connection;
11. **VIDEO OUTPUT:** loop-through video outputs;
12. **Ethernet:** RJ-45 socket for net computer connection;

DEVICE POWER UP

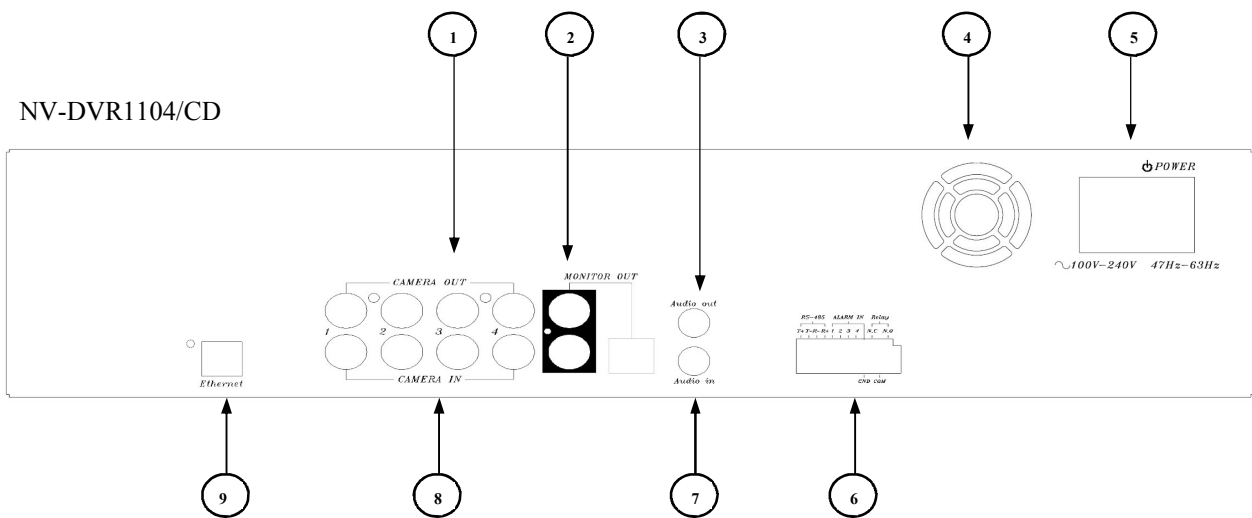

eng

- | | | |
|----|---------------------------------|--|
| 1. | <i>CAMERA OUT:</i> | loop-through video outputs; |
| 2. | <i>MONITOR OUT:</i> | main monitor connection (1 x BNC and 1 x S-Video connectors available); the possibility of selection from various display modes; |
| 3. | <i>Audio out :</i> | RCA audio output; |
| 4. | | cooling fan (do not cover!); |
| 5. | <i>POWER ~90~260V :</i> | Power supply socket; |
| 6. | <i>ALARM,RS-232/485:</i> | alarm inputs, alarm outputs, remote control and PTZ camera control terminal; |
| 7. | <i>Audio in:</i> | 1 x RCA audio recording input; |
| 8. | <i>CAMERA IN:</i> | video inputs for camera connection; |
| 9. | <i>Ethernet:</i> | RJ-45 socket for net computer connection; |

DEVICE POWER UP

2.3 External Devices Connection

All installation procedures should be conducted by qualified personnel. Before device installation and operation please analyze the scheme shown below. Depending on specific user needs and requirements each system will consist of various number of external devices.

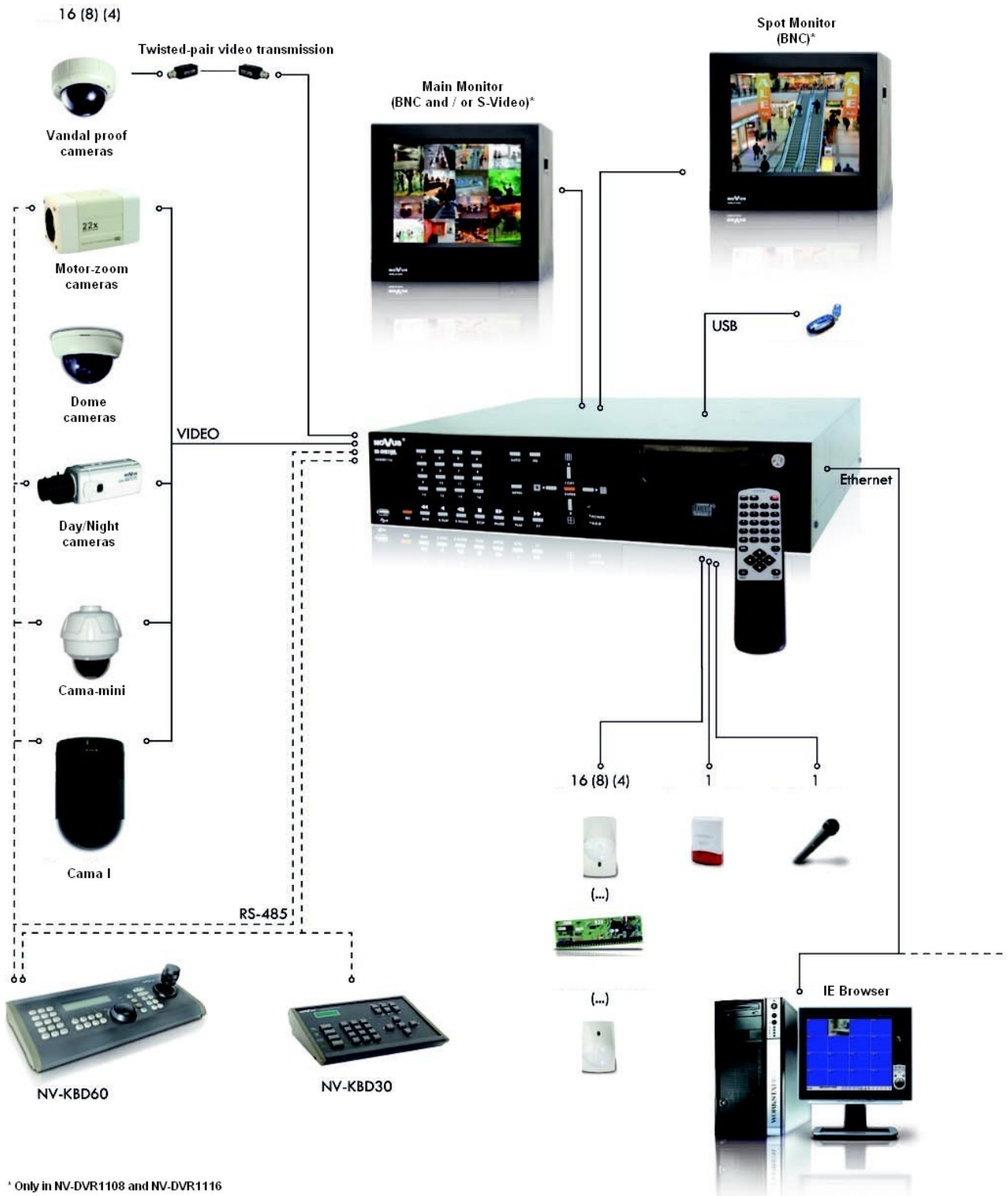

DEVICE POWER UP

2.4 HDD Installation

NV-DVR1104/CD, NV-DVR1108/CD and NV-DVR1116/CD digital multiplexers allows to install two HDD's: one disk installed inside the device and the other one placed in swappable bay.

NOTICE: **Producer advices utilizing HDD's manufactured by Hitachi.
Max. allowed capacity of single HDD is 400GB.**

WARNING: **Producer strongly advices against utilizing Samsung or Western Digital HDD's.
Novus does not take any responsibility for problems caused by using improper
HDD.**

Before installing HDD please make sure that jumpers are set properly!
When using only one HDD it must be set in MASTER mode. When using two HDD's, one of them must be set in MASTER mode and the second in SLAVE mode. HDD configuration, of specified type and manufacturer, is described in the HDD manual supplied with the HDD.

WARNING: **Take into consideration that in case of using HDD from other device (other
multiplexer or PC) while first multiplexer activating all data from HDD will be
erased.**

2.4.1 Swappable bay HDD installation

Before installation disconnect power supply cord.
Place the properly set HDD in swappable bay and then screw it on to the casing utilizing 4 supplied screws. Place the swappable bay in the multiplexer and close it with the key, attached in the package.

2.4.2 Internal HDD installation (inside the DVR)

NOTICE:

**Internal HDD should be installed by qualified service personnel.
If the Multiplexer housing is opened by unqualified person the warranty is voided.**

eng

DEVICE POWER UP

2.5 Device turn on and turn off.

Before turning on the device please make sure that the power supply (voltage and frequency) conforms to device requirements. Also make sure that the power switch is set to „0”, HDD swappable bay is locked with the key and that the all external devices are connected properly.

WARNING: We do not advice to connect any additional devices (such us cameras, monitors, etc..) while device operation.

eng

Device power on is activated by switching the power switch to position „1”.

The loading procedure of the operating system takes about 30 seconds.

During this procedure various information will appear on the screen.

During this procedure please do not press any buttons on the front panel of this device.

The loading procedure is finished when camera images will appear on the Main monitor along with their descriptions and the system time.

To power off the device stop the recording and shut down the device using power switch.

FRONT PANEL DESCRIPTION

3. Front Panel Description

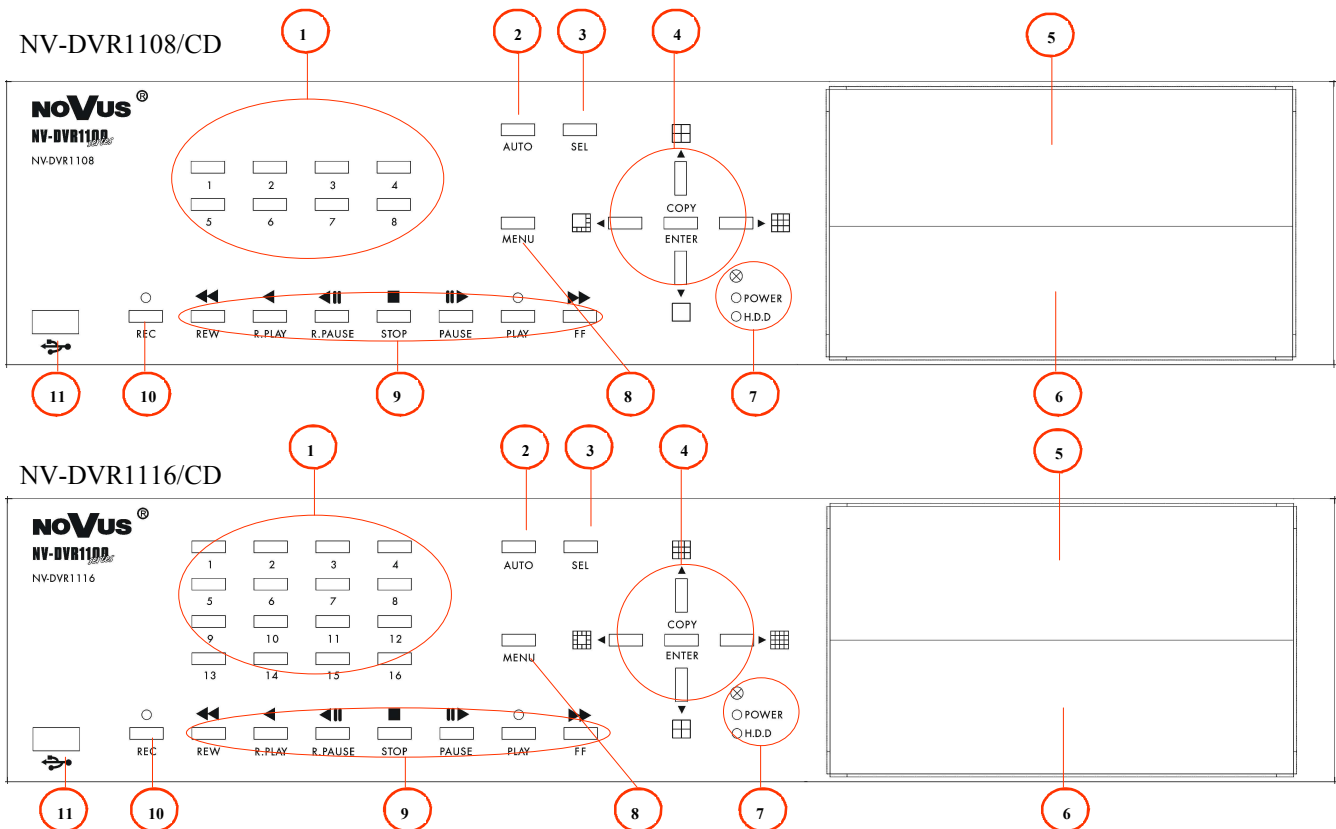

1. Displayed channel selection;
2. **AUTO** pressing **AUTO** button activates sequential display mode on Main monitor;
3. **SEL** Channel selection; each additional press of this button toggles between various, available display formats ;
4. Toggles between different display formats;
In setting mode these buttons are used as a cursor buttons;
In PTZ mode these buttons are used to control the camera;
ENTER in setting mode is used to enter submenu and edition bars ;
COPY in playback mode activates backup procedure on flash memory;
5. HDD swappable bay;
6. CD-RW recorder;
7. IR receiver; LED's;
8. **MENU** On Screen Display menu activating;
9. Playback control buttons;
in PTZ mode some buttons are used for camera control;
10. **REC** manual recording activating/ deactivating (inactive in schedule recording mode);
11. USB port for flash memory card connection;

FRONT PANEL DESCRIPTION

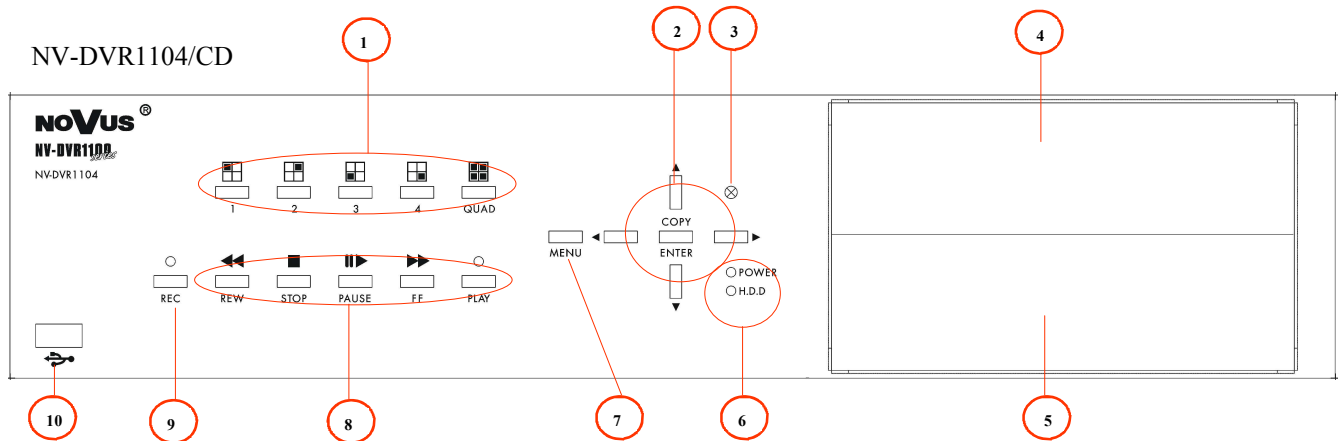

1. Displayed channel or quad selection;
2. Cursor buttons;
In PTZ mode these buttons are used to control the camera;
- ENTER** in setting mode is used to enter submenu and edition bars ;
- COPY** in playback mode activates backup procedure on flash memory;
3. IR receiver;
4. HDD swappable bay;
5. CD-RW recorder;
6. LED's;
7. **MENU** On Screen Display menu activating;
8. Playback control buttons;
in PTZ mode some buttons are used for camera control;
9. **REC** manual recording activating/ deactivating (inactive in schedule recording mode);
10. USB port for flash memory connection;

DEVICE MENU

4. DEVICE MENU

NV-DVR1104/CD, NV-DVR1108/CD and NV-DVR1116/CD digital multiplexers are equipped with multi level OSD (on screen display) sub-menus. This menus are used to program settings and to execute functions such us playback or copying

In order to enter device menu press **MENU** button.

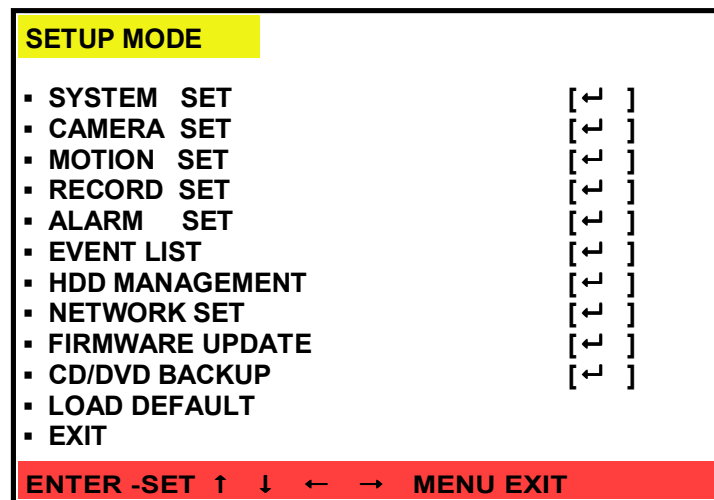

Main menu consists of 11 submenus. The contents of sub-menus are described on following pages of this manual.

These buttons ▲ ▼ are used to select menu items.

Submenus with the possibility of entry are marked with symbol [↔]

ENTER button is used for selection approval, entry to submenu or to edition bar. After entering edition bar the contents will be highlighted with yellow color.

To modify selected value use buttons ◀ ▶.

Exiting the menu accepts and saves inputted modifications.

in some cases system restart is required (system message will be displayed)

In order to exit selected menu or to return to the higher level menu from individual sub-menus and modification fields **EXIT** option should be selected and **ENTER** button must be pressed. Pressing **MENU** button acts similar to the procedures described above.

NOTICE: In case factory default OSD language is different than English press **MENU** button, select first menu item, press **ENTER**, select 1th menu item and choose desired language, exit from menu. An example below shows changing language from Polish to English.

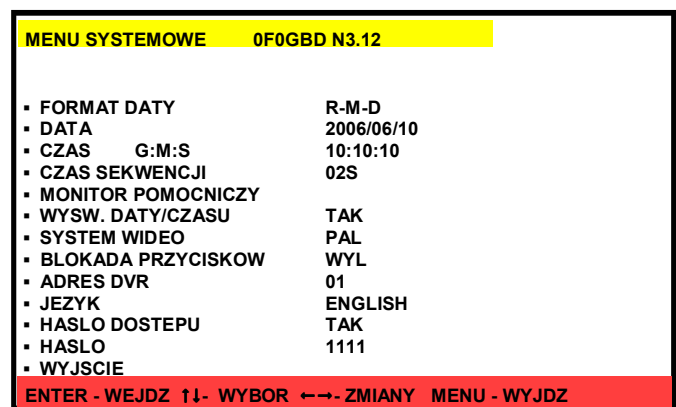

DEVICE MENU

4.1 System setup

SYSTEM SETUP		0F0GBD N3.12
▪ DATE FORMAT		Y-M-D
▪ DATE		2006/06/10
▪ TIME	H:M:S	10:10:10
▪ AUTO SWITH DWELL		02 SEC
▪ SPOT SETUP		[←]
▪ DATE AND OSD DISPLAY		ENABLE
▪ SYSTEM TYPE		PAL
▪ KEYBOARD LOCK		OFF
▪ ID NUMBER		01
▪ LANGUAGE SELECT		ENGLISH
▪ PASSWORD MODE		ENABLE
▪ PASSWORD		1111
▪ EXIT		

ENTER -SET ↑ ↓ ← → MENU EXIT

Utilizing **SYSTEM SETUP** menu following system settings may be applied:

- (1) **DATE FORMAT** one of three date formats available can be selected (displayed)0,,
Y- year, M- month, D- day;
- (2) **DATE** date setting;
- (3) **TIME** time setting;

When multiplexer is network connected and all settings are executed there is possibility of manual time synchronization between the multiplexer and standard time server (NTP protocol). Enter time setting field and press 1 button for approximately 3 seconds. Following message will be displayed:

[CAUTION]
WILL BE SYNCHRONIZED WITH NTP
ARE YOU SURE?
▪ YES ▪ NO

If **YES** is selected system time will be synchronized.

- (4) **SEQUENCE TIME** display time of each camera in sequence mode on Main
monitor, time is defined in seconds (2-99s range)
- (5) **SPOT MONITOR** when this option is selected and **ENTER** button is pressed
spot monitor submenu is displayed;

CAUTION: only full screen display mode is available on spot monitor (divided screen is unavailable). On Split monitor there are no descriptions displayed (camera name, system time, etc.) DVR software version information is displayed on the yellow background.

DEVICE MENU

in order to activate sequence mode on spot monitor *SPOT SWITCHING* position should be set to *ON*.

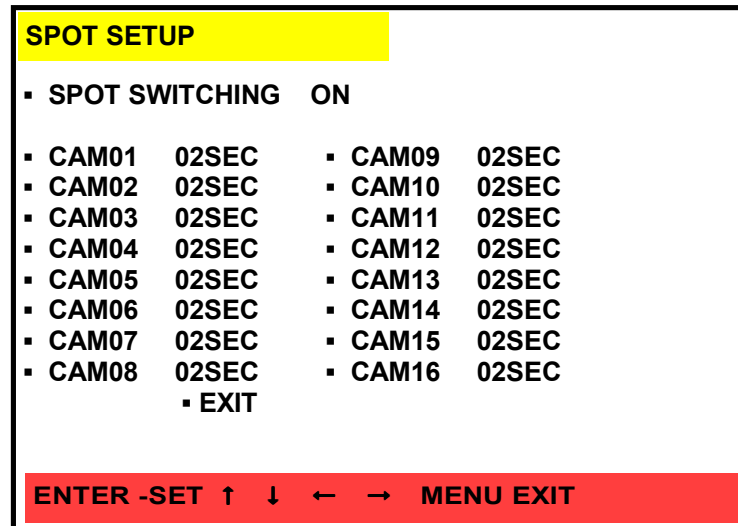

eng

When sequence mode is active, display time can be settled individually for each camera in seconds (1 to99). If camera is set to *OFF* image from this camera automatically will not be displayed in sequence mode.

CAUTION: camera image, which is displayed in sequence mode on spot monitor, can be a bit brightened on main monitor. Therefore it is recommended to turn off sequence mode when the spot monitor is unused.

When motion detection and alarm inputs are active automatic sequence mode is aborted for the event duration. in his time only alarm camera will be displayed. Displaying time depends on alarm settings.

If *SPOT SWITCHING* position is set to *ON*, the last selected or last alarm camera from main monitor will be displayed on spot monitor (when motion detection or alarm inputs are active)

- (6) **TIME DISPLAY** if this option is set to *ON* time/date information will be displayed on the main screen;
- (9) **SYSTEM SELECT** This option is used to select TV system standard. *PAL* or *NTSC* system can be selected.

DEVICE MENU

- (8) **KEY LOCK** this position is used to select multiplexer access protection mode. Together with system password it limits (reduces) access to selected functions. When **TYPE 1** is selected after exiting main menu, recording and playback functions are unavailable from the front panel. **When TYPE 2** is selected after exiting main menu, all front panel buttons are blocked except for **MENU** button. Key lock is deactivated when **OFF** is selected
- (9) **DVR ID NUMBER** this option enables to establish DVR ID, which is necessary for multiplexer remote control, using system keyboards: NV-KBD30 i NV-KBD60. ID number should be selected using 1 to 9 digits. System keyboard connection is described in 11 unit. Keyboard user's manual is attached to the keyboard set.
- (10) **LANGUAGE** OSD language selection
- (11) **ACCESS PASSWORD** if this option is set to **ON**, access password is required when entering main menu. Additional menu line appears below;
- PASSWORD** This option is used to set a 4 digit password

CAUTION: factory default password is: 1111. please do not forget your new selected password. In order to recover forgotten password, service help is indispensable.

When Password checking function is active, each **MENU** button press will generate following system window. Use cursor buttons to introduce any password changes.

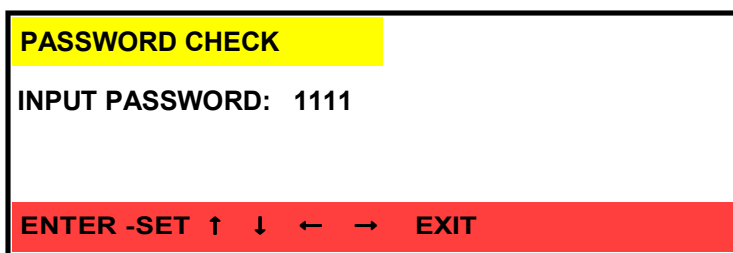

4.2 Camera setup

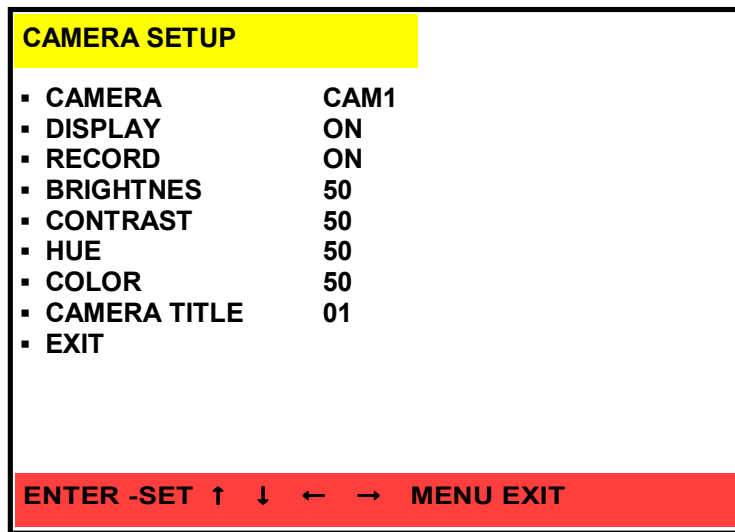

eng

In **CAMERA SETUP** menu following settings can be set individually for each video channel:

- (1) **CAMERA** This option is used to select specific channel number for the camera, of which settings should be displayed or modified;
- (2) **DISPLAY** if this option is set to **OFF** camera image will not be displayed on main monitor in live mode (blue image will be displayed). Camera image will be still displayed on spot monitor. Covert channel recording is still active and in playback mode it will be visible. in order to display camera image on main monitor set his option to **ON**;
- (3) **RECORD** if this option is set to **OFF** the image from selected camera will not be recorded, however it still will be displayed on the screen. In order to record image from selected camera set this option to **ON**;
 When recording mode is set to **ON**, camera title is displayed in red color
 When recording mode is set to **OFF**, camera title is displayed in white color.
- (4) **BRIGHTNESS** This menu options allow to adjust the parameters of displayed image according to user's individual needs and requirements. The default value is 50;
CONTRAST
COLOR
HUE
- (5) **CAMERA TITLE** this option allows to define camera title, which will be displayed on the screen. Camera title can consist of 6 characters.
 Default displayed camera name is channel number e.g. 01, 02

DEVICE MENU

4.3 Motion detection

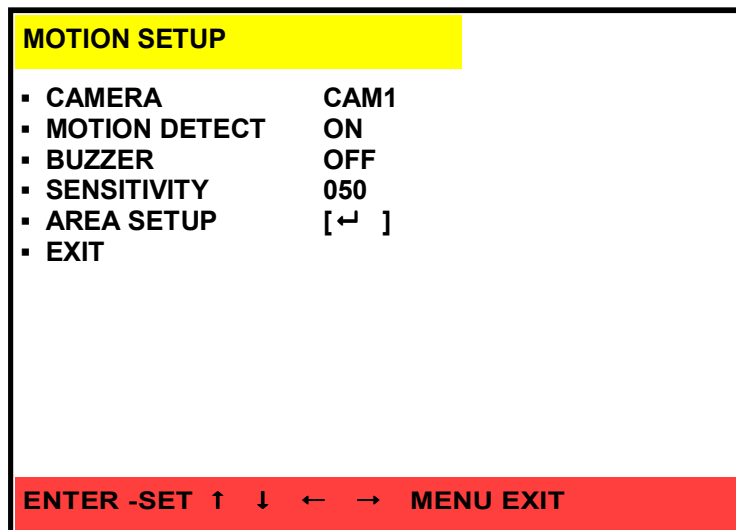

In **MOTION DETECTION** menu following settings can be set individually for each video channel:

- (1) **CAMERA** this option is used to select specific channel number for the camera of which settings should be displayed or modified;
- (2) **MOTION DETECT** when this option is set to *ON* any motion detection in camera image activates alarm mode. in Alarm recording mode camera name is displayed in yellow color. When this option is set to *OFF* motion detection is not analyzed and all remaining menu lines are not displayed;
- (3) **BUZZER** when this option is set to *ON* and motion is detected, sound signal is activated;
- (4) **SENSITIVITY** This option allows to define the sensitivity of motion detection. It helps to evade (avoid) unnecessary false alarms caused for example by moving leafs etc.. This option can be adjusted in the range from 1 to 100. The higher value of motion detection makes it more sensitive;

DEVICE MENU

(5) **AREA SETUP**

when this position is selected and **ENTER** button is pressed , the motion detection zone screen (16x12) is displayed.

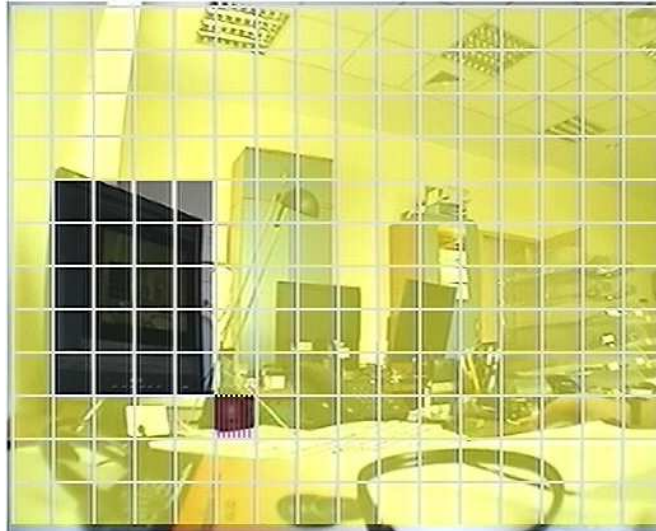

Zones, where motion detection is active are marked with yellow color. Black color means that the zone is inactive. Please use cursor buttons to move within the motion detection zone. in order to activate/deactivate single zone **ENTER** button should be pressed. In order to activate/deactivate all line **SEL** button should be pressed.

When the motion, in camera image, is detected, multiplexer switches to alarm recording mode automatically. Parameters of alarm recording are set in **RECORDING** menu in Alarm Recording position. Camera title will be displayed in yellow color. Camera image can be displayed in full screen mode and sound signal can appear. Notice on motion detection will be also added to the Event List.

Motion detection operates even if recording mode is inactive. in this situation alarm recording will not be activated but all described actions will be run (depending on settings).

eng

DEVICE MENU

4.4 Recording

RECORD SETUP	
▪ SCHEDULE RECORD	OFF
▪ NORMAL RECORD FPS	25P
▪ ALARM RECORD FPS	50P
▪ ALARM RECORD DWELL	5 SEC
▪ RECORD QUALITY	HIGH
▪ AUDIO RECORD	ON
▪ EXIT	

ENTER -SET ↑ ↓ ← → MENU EXIT

In **RECORD SETUP** menu following settings can be adjusted:

- (1) **SCHEDULE** This function is used to set various recording modes for different periods of time. If this option set to **ON** Schedule recording is activated. in order to enter Schedule submenu **ENTER** button must be pressed. For more details on programming Schedule recording see chapter 5..
- (2) **NORMAL RECORD** This option is used to set recording speed for normal and manual recording. Speed values are expressed in fields per second rate. Following values are available: *100, 50, 25, 12, 5, 1, 0,5, 0,2* and *0* . Recording speed applies to entire multiplexer. Depending on number of recording cameras the multiplexer resources are equally divided between each camera. When only one camera is recorded it is not recommended to select **50P** speed. This position is available only when schedule recording is inactive.
- (3) **ALARM RECORD** This option is used to set recording speed during alarm mode (alarm inputs and motion detection). Speed values are expressed in fields per second rate. Following values are available: *100, 50, 25, 12, 5, 1, 0,5, 0,2, and 0*. Recording speed applies to entire multiplexer. Depending on number of recording cameras the multiplexer resources are equally divided between each camera. When only one camera is recorded it is not recommended to select **50P** speed. This position is available only when schedule recording is inactive.

DEVICE MENU

- (4) **ALARM RECORD DWELL** Time defined in seconds describing the alarm duration.
This setting allows to record in alarm mode for longer periods of time than the duration of alarm event;
- (5) **RECORD QUALITY** This option defines the recording image compression level along with the recording quality level. 4 quality levels are available: **LOW, MEDIUM, HIGH, BEST**. The total duration of recording time for specific HDD depends on recording quality settings. Information concerning recording time might be obtained from **DVRcalc** our freeware software available as well on CD and Novus web site.
- (6) **AUDIO RECORD** when this option is set to **ON** audio recording is available.

CAUTION: audio recording is not recommended while recording at speed lower than **5 P**

eng

DEVICE MENU

4.5 Alarm setup

ALARM SETUP		
BUZZER		
▪	BUZZER/ALARM DWELL	05SEC
▪	VIDEO LOSS ALARM	ON
▪	AUDIBLE ALARM	OFF
▪	EXT. ALARM MODE	N.O.
▪	ALARM DISPLAY MODE	DISABLE
▪	MOTION EVENT	OFF
RELAY		
▪	EXT. ALARM RELAY	ON
▪	VIDEO LOSS RELAY	ON
▪	MOTION RELAY	ON
▪	EXIT	
ENTER -SET ↑ ↓ ← → MENU EXIT		

In **ALARM SETUP** menu following settings can be adjusted:

- (1) **BUZZER/ALARM DWELL:** this option is used to set buzzer dwell time after alarm detection;
- (2) **VIDEO ALARM LOSS:** when this option is set to **ON** sound signal is activated whenever signal from camera is lost;
- (3) **AUDIBLE ALARM:** when this option is set to **ON** sound signal is activated; if this option is set to **OFF** sound signal stays inactive;
- (4) **EXT.ALARM MODE.:** this option is used to suit alarm outputs to external devices. When **NC** option is selected alarm signal is activated by alarm circuit openly. This solution is used in connection with passive motion detectors. When **NO** option is selected alarm signal is activated by alarm circuit closely. this solution is used in connection with various switches, reed relays, etc;

DEVICE MENU

- (5) **ALARM DISPLAY MODE:** If this option is set to *ON*, alarm camera will be displayed in fullscreen mode. If this option is set to *OFF* in case of alarm detection all cameras will be displayed in the same mode as before the event;
- (6) **MOTION EVENT:** If this option is set to *ON* each motion detection is noted in system registry. If this option is set to *OFF* motion detection function and alarm recording are active but there will be no event notice in system registry;
- (7) **EXT. ALARM RELAY.:** if this option is set to *ON* alarm relay will be activated in case of external alarm;
- (8) **VIDEO LOSS RELAY:** if this option is set to *ON* alarm relay will be activated in case of video loss
- (9) **MOTION RELAY:** if this option is set to *ON* motion relay will be activated by motion detection in camera with active motion detection function;

eng

DEVICE MENU

4.6 Event List

EVENT LIST		MASTER PAGE: 001		
NO	YY / MM / DD	HH:MM:SS	CH	TYPE
01	2006 / 06 / 12	15: 22: 36	01	ALARM
02	2006 / 06 / 12	14: 22: 36	01	V.LOSS
03	2006 / 06 / 12	14: 21: 36	--	RECORD
04	2006 / 06 / 12	13: 12: 34	02	MOTION

ENTER -SET ↑ ↓ ← → MENU EXIT

When *EVENT LIST* is entered system history is available. The system registry stores up to 2000 events recorded from the last HDD formatting. When 2000 number is exceeded the oldest events are overwritten with the latest events.

When two HDDs are installed in the device there is possibility to store 2000 events on Slave and 2000 events on Master HDD.

Events are classified according to the time of occurrence. Latest events are displayed as first. When there are more events than can be displayed on one page additional events are displayed on following system registry pages. HDD and page number, to which registry (event) refers are displayed in the top of the screen. In order to proceed to following pages please use cursor buttons ◀ ▶. in order to playback records, which are connected with the event, cursor buttons ▲ ▼ should be used (for required record selection) and *ENTER* button should be pressed.

Event information are divided in columns.

The first column consists of event number, second - event date, third - event time, fourth - the event camera number, which event refers to („--” sign means that event refers to entire system).

The fifth column consists of shortenings describing event type:

- *MOTION* motion detection activation
- *V.LOSS* signal loss
- *RECORD* start recording
- *ALARM* alarm on the alarm input
- *POWER* system reboot due to power failure

4.7 HDD management

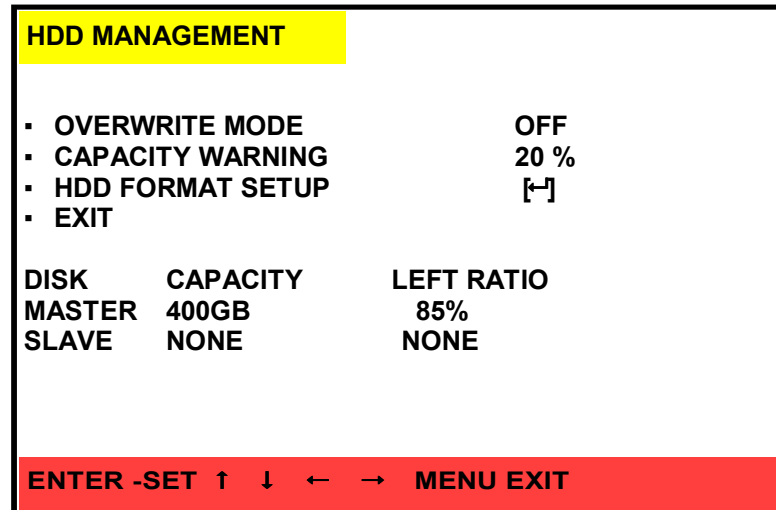

eng

The **HDD MANAGEMENT** menu is used to define following HDD settings:

- OVERWRITE MODE:** This option is used to select recording mode on HDD. If this option is set to **ON** the recording process will be „repeated”. It means that if a 11 HDD capacity reserved for recording has been already used the system will start overwriting data previously stored on that HDD (starting from the point of the oldest records). Previously stored data will be lost;

If this option is set to **OFF** the system will stop recording process when all available HDD capacity is used. “Disk Full” system notification will appear on the screen in the event of low HDD capacity left for recording;
- CAPACITY WARNING:** This option allows to define, when the „Full Disk” system notification should appear. This setting is expressed in percentage. Following values are available 5%, 10, %, 15 %, 20%. In the example shown above the notification will appear when disk free space will drop to 20%. If **OVERWRITE MODE** is set to **ON** this menu line does not appear;

DEVICE MENU

- (3) **HDD FORMAT SETUP:** in order to enter **HDD FORMAT** submenu select (highlight) this position and press **ENTER** button

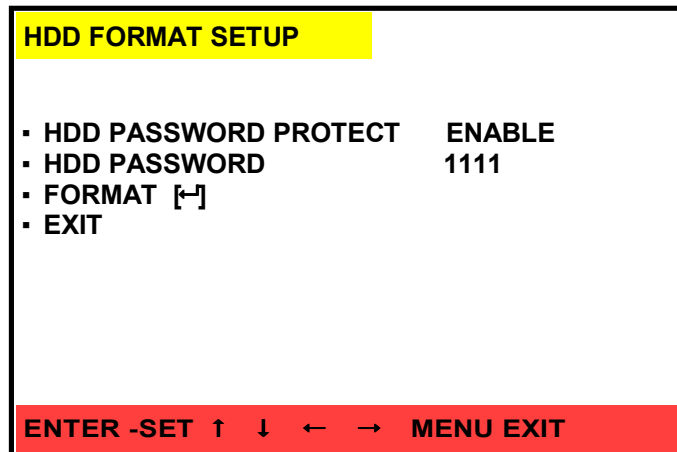

- (a) **HDD Password Protect:** if this option is set to **ENABLE**, HDD formatting will be protected by four-digit password;
- (b) **HDD Password:** this position is used to set-up four-digit password which will be required when HDD formatting. This password does not affect on main system password.

CAUTION: factory default password is: 1111. Please do not forget your new selected password. If new password is forgotten all default settings must be restored

- (c) **FORMAT:** if this option is selected and **ENTER** button is pressed data loss warning will be displayed. If **YES** option is selected and **ENTER** button is pressed all data, from all connected HDDs, will be erased. If **NO** option is selected formatting will be deactivated;

CAUTION: please take extra caution when using Format function. When formatting HDDs all data are erased irrevocable

Additionally in **HDD MANAGEMENT** menu information on HDD capacity and usage is displayed. If specific HDD is not installed **NONE** message will be displayed.

4.8 Network setup

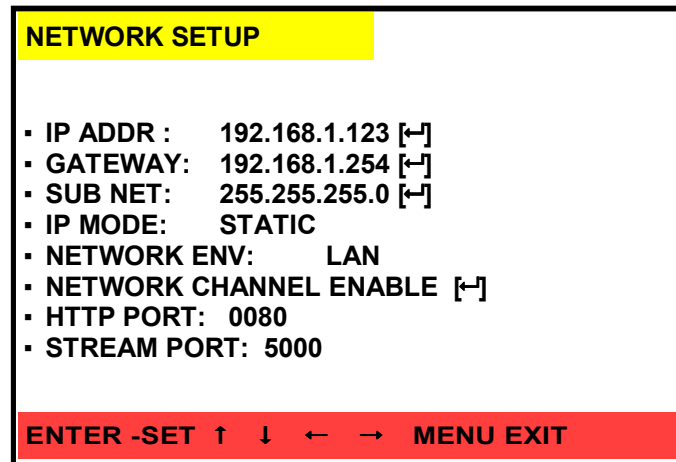

eng

The **NETWORK SETUP** menu allows to configure network settings. Before configuration, please contact your network administrator in order to settle proper and allowed network parameters, which will be adjusted in this menu.

- (1) **IP ADDR:** unique IP address within the network;
- (2) **GETAWAY:** Internet getaway for external network connections;
- (3) **SUB NET:** in this option subnet mask can be selected;
- (4) **IP MODE:** addressing (IP) mode selection: **STATIC**-manual parameter settings, **DHCP** - automatic parameter settings, provided automatically by DHCP Server, in this option first 3 positions are unimportant;
- (5) **NETWORK ENV:** this function is used for network type selection. According to selected network type various bandwidths are available. It helps to fit data transmission to network capacity.
If this option is set to **CROSSOVER** up to 4.5Mbit/s data transfer is available.
If this option is set to **LAN** up to 2.5Mbit/s data transfer is available.
If this option is set to **WAN** up to 1.5Mbit/s data transfer is available.
- (6) **NETWORK CHANNEL:** this option enables for channels selection, which will be transmitted via network. In default settings all channels are transmitted via network.
- (7) **HTTP PORT:** network port selection (0~6500), which is used for image transmission;
- (8) **STREAM PORT:** network port selection (0~6500), which is used for control commands transmission;

CAUTION: please make sure that in case of external network connection both ports are opened and/or properly rerouted onto network devices.

DEVICE MENU

4.9 Firmware update

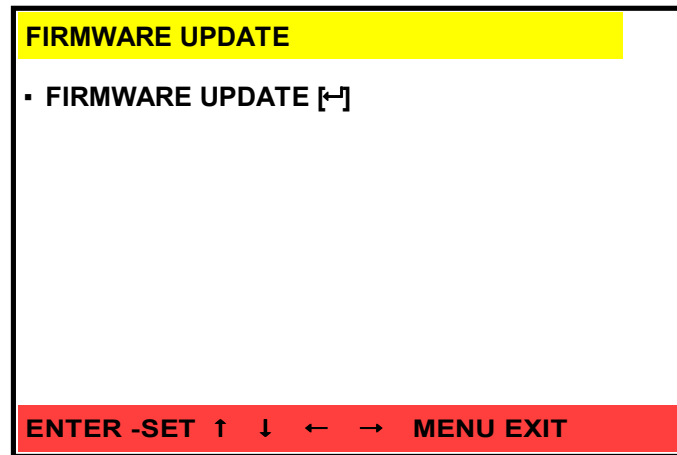

The **FIRMWARE UPDATE** Menu is used for device firmware updating.

CAUTION: before firmware updating please consult it with your NOVUS products distributor.

In order to update the firmware, copy files on flash memory, than insert this memory into DVR USB port and press **ENTER** button.

When data copying is done, system restore message will be displayed.

If flash memory is not detected, following message will be displayed:

**PLEASE INSERT USB
TRY AGAIN!**

4.10 CD/DVD BACKUP

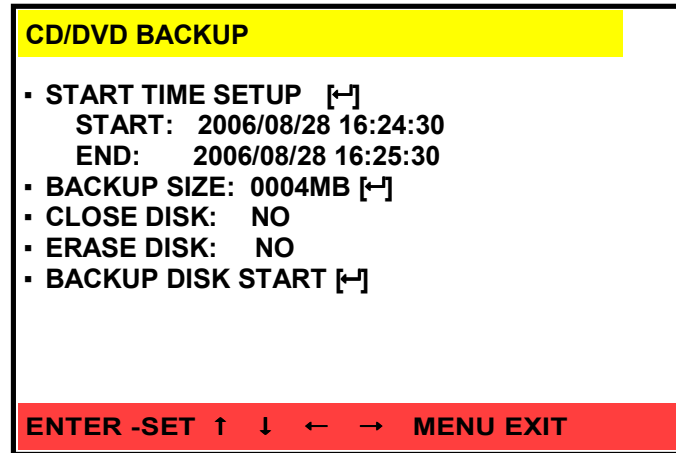

eng

CD/DVD BACKUP menu is used to adjust CD/DVD backup settings.

- (1) **START TIME SETUP:** period of time, whereof records will be copied on CD/DVD;
- (2) **BACKUP SIZE:** backup data size, expressed in MB;
- (3) **CLOSE DISK:** if this option is set to *ON* disk session will be closed after burning;
- (4) **ERASE DISK:** if this option is set to *ON* all data from CD/RW will be erased;
- (5) **BACKUP DISK START:** if this position is selected and *ENTER* button is pressed, backup function or CD/RW erasing is activated;

NOTICE: Only CD backup is available. DVD-ROM's are not supported.

Detailed information regarding CD and flash memory card backup is described in chapter 7.

4.11 Default setup

When *LOAD DEFAULT* menu is selected default settings are restored

RECORDING

5. RECORDING

NV-DVR1104/CD, NV-DVR1108/CD and NV-DVR1116/CD multiplexers allow for manual (activated by orange **REC** button) and schedule recording. In all recording modes only channels with active recording function are recorded (see chapter 4,2)

Current recording status can be monitored by observing descriptions displayed on the screen and LEDs on device's front panel.

If there is no description displayed on the screen **ENTER** button should be pressed till required screen mode appears.

- If **REC** inscription is displayed in red color, it means that at the given moment recording is progressed with recording speed which value is displayed in upper right corner. Recorded cameras descriptions are displayed in red color. Additionally red LED lights above **REC** button and yellow H.D.D. LED blinks. In case of event, alarm camera description turns into yellow color.
- Yellow **|A|** inscription, means that device operates in alarm recording mode. In case of event all descriptions will turn into described above. In stand-by mode LED above **REC** button and H.D.D. LED do not light. Recording speed which is displayed in stand-by mode does not refer to alarm recording. It is continuous recording speed, which can be activated manual, by pressing **REC** button. This option allows to activate recording even if recording was not activated automatically. In order to return to stand-by mode **REC** button should be pressed.
- Yellow **|X|** inscription in left corner, means that device does not record. In this mode LEDs do not light. Cameras inscriptions are displayed in white color (yellow color in case of event). Recording speed which is displayed in stand-by mode does not refer to alarm recording. It is continuous recording speed, which can be activated manual by pressing **REC** button. This option allows to activate recording even if recording was not activated automatically. In order to return to stand-by mode **REC** button should be pressed. When device does not record, alarm functions operate in incomplete range; it means that alarm relay and audio signal can be activated even if camera images are not recorded.

eng

RECORDING

5.1 Manual Recording

If *SCHEDULE RECORDING* option, in *RECORD* menu, is inactive, the device operates as follows:

- If orange *REC* button is pressed active channels recording is activated. Red *REC* inscription is displayed in left upper corner of the screen. Continuous recording will be run with speed set in *CONTINUOUS RECORDING* position in *RECORD* menu (in alarm mode, recording will be run with speed set in *ALARM RECORD* menu). Recording speed information is displayed in right upper corner. To stop recording press *REC* button one more time.

When *SCHEDULE RECORDING* option in *RECORD* menu is active, the device operates as follows:

- When continuous Schedule recording is run and orange *REC* button is pressed following message is displayed on the screen:

SCHEDULE RECORDING..

Recording mode will not change.

- When alarm recording is run in schedule or device does not record, and *REC* button is pressed multiplexer starts recording of active cameras. Red *REC* inscription will be displayed in left upper corner. Recording will be run continuously with recording speed set in schedule recording menu.

NOTICE: if recording mode has been changed manual it must be cancelled in order to return to schedule recording

Records quality refers to settings set in *RECORD QUALITY* in *RECORD* menu, irrespective to recording mode.

eng

RECORDING

5.2 Schedule recording

NV-DVR1104/CD, NV-DVR1108/CD and NV-DVR1116/CD represents schedule recording function with various recording modes during the day.

CAUTION: To activate schedule recording set to *ON* in *SCHEDULE RECORDING* option in *RECORD* menu.

eng

Schedule recording can be set individually both for working days and for weekend. Schedule recording can be run with various parameters during the day. Recording mode can be adjusted individually according to working hours of monitored objects.

Images quantity refers to *RECORD QUALITY* settings in *RECORD* menu, irrespective to recording mode.

When setting recording modes and during device operation, following letters are used:

O - this option is used for continuous recording

|A| - this option is used for alarm recording

|X| - this option is used when recording process does not occur

Programming of schedule recording is described in following example.

EXAMPLE

According to working hours in monitored object continuous recording will be run with 25fps recording speed from 8am to 4pm for each working day. Motion detection and alarm events will not influence on recording speed. After working hours device will switch into alarm recording mode; recording will be run with 50 fps recording speed.

On Saturday and Sunday device will record only in alarm mode with 50 fps recording speed.

Please, select *WEEKDAY* shortcut using cursor buttons *▲ ▼*. Selected position will be highlighted with yellow color. Using cursor buttons *◀ ▶* *MON* position should be set. Than second shortcut should be set as *FRI*. In *START-STOP* position start hour should be set as *08* and end hour should be set as *16*. Proceed to *TYPE* column and select *O*. *P/S* column should be set to *25P*, and *ALARM P/S* column should be set to *50P*.

RECORDING

Second hour section in *WEEKDAY* position will be set automatically as *16-08* hour section. Only recording mode and speed should be adjusted for normal and alarm recording. Normal recording speed matters only if recording mode is adjusted manual by operator within *16-08* section.

Settings in *WEEKEND* section can be adjusted analogically.

As a terminal effect of described above schedule recording settings, following window should be displayed:

SCHEDULE RECORD				O : FULL RECORD
				[A]: ALM RECORD
				[X]: NO RECORD
WEEKDAY.: MON-FRI				
START-STOP	TYPE	FPS	ALM FPS	
08-16	O	25P	25P	
16-08	A	50P	50P	
WEEKEND: SAT-SUN				
START-STOP	TYPE	FPS	ALM FPS	
0-24	A	50P	50P	
EXIT				
ENTER -SET ↑ ↓ ← → MENU EXIT				

eng

PLAYBACK

6. PLAYBACK

NV-DVR1104/CD, NV-DVR1108/CD and NV-DVR1116/CD allow to find desired recordings in two ways. First search option can be done by inputting specified time and date. Second search option is possible by viewing the event registry and playback of recordings related to the selected event.



Devices operate in a triplex mode that allows for simultaneous recording, monitoring and networking.

CAUTION: simultaneous playback of various records locally and via network is unavailable. In case of simultaneous local and network playback both users will watch records from the same date. Various screen display modes are available.

6.1 PLAY TIME SEARCH

When this option is selected time and date menu will be displayed. Additionally available recording range information will be displayed in the bottom of the screen.

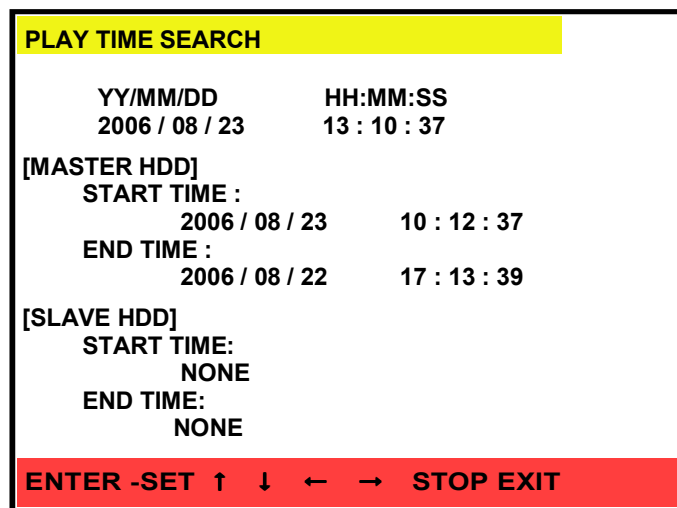

Time and date can be set using ▲ ▼ buttons. Each menu item (i.e. year, month) can be selected using ◀ ▶ buttons. Selected area will be highlighted with yellow color.

PLAYBACK

When ENTER button is pressed playback is initiated.

NOTICE: if high capacity HDDs are installed in the device data loading can take up to several seconds. During this time following message will be displayed on the top of the screen:

LOADING, PLEASE WAIT...

Playback is automatically activated in 9 or 16 screen division (according to multiplexer version)

During playback it is possible to toggle between display modes using cursor buttons

During playback following buttons are active:

PLAY - forward playback

R.PLAY - backward playback

FF - forward playback speed change, during playback additional press switches playback speed to x2, x4, x8, x16, x32

REW - backward playback speed change, each additional press switches playback speed to x2, x4, x8, x16, x32

CAUTION: if playback is run with playback speed more than x2 and simultaneous recording is run, records will not be played back fluently.

PAUSE - pause button, if this button is pressed for the first time playback is stopped and single image is displayed; each additional press allows to forward records browse by 0,5 s.;

R.PAUSE - pause button, if this button is pressed for the first time playback is stopped and single image is displayed; each additional press allows to backward records browse records by 0,5 s.;

STOP - playback stop and playback menu exit;

eng

PLAYBACK

6.2 EVENT LIST SEARCH

This searching method is very similar to recorded data search described in 6,6 chapter. The only difference is that in this case it is possible to define period of time, whereof events will be displayed.

If *EVENT LIST* option is selected, following screen will be displayed:

EVENT LIST		MASTER PAGE: 001		
NO	YY / MM / DD	HH:MM:SS	CH	TYPE
01	2006 / 06 / 12	15: 22: 36	01	ALARM
02	2006 / 06 / 12	14: 22: 36	01	V.LOSS
03	2006 / 06 / 12	14: 21: 36	--	RECORD
04	2006 / 06 / 12	13: 12: 34	02	MOTION
ENTER -SET ↑ ↓ ← → MENU EXIT				

Event list usage is described in chapter 4.6

During playback all described in previous chapter buttons are active

7. RECORDED DATA BACKUP

7.1 Flash memory backup

NV-DVR1104/CD, NV-DVR1108/CD and NV-DVR1116/CD are equipped with USB interface, allowing to connect flash memory.

NOTICE: HDD data backup via USB interface is unavailable

Size of copied file depends on time of copied file, recording speed and image quality. All recorded channels are copied.

One minute of data recorded with 50 IPS recording speed at high quality image occupies 5 MB of HDD after backup

NOTICE: during USB backup process computer network connections are hung. In order to restore image, when data backup is done network connection should be refreshed in IE Web browser

In order to USB flash data backup insert memory stick into USB port on front panel of device, initiate playback process and search for the beginning of required record. Subsequently during playback with normal speed **ENTER** button should be pressed.

After a while files backup will be initiated and following yellow inscription will be displayed at the top of the screen:

USB BACKUP START

If memory card is not detected following message will be displayed:

SAVE FAIL!

PLEASE CHECK USB!

In order to complete backup **ENTER** button should be pressed.

Following message will be displayed on the screen:

USB PROCESS, PLEASE WAIT!

Do not disconnect memory card during recording

Subsequently following message will be displayed:

SAVE OK

After message disappearing memory card can be disconnected.

Along with required file, *player.exe* player file will be copied on memory card . This player enables to playback copied file on PC. Player functions are described in chapter 11.

Copied file's name includes backup time and date. This information is downloaded from devices system clock.

In example: „08300743.06” name , means that file was copied on 30 of August at 07.43; 2006 year.

BACKUP

7.2 CD backup

NV-DVR1104/CD, NV-DVR1108/CD and NV-DVR1116/CD are equipped with built-in CD-RW recorder. It enables to backup records on CD-R and CD-RW. In order to avoid compatibility and copy durability problems only reputable CDs are recommended.

NOTICE: DVD backup is unavailable..

Size of copied file depends on time of copied file, recording speed and image quality. All recorded channels are copied.

NOTICE: during CD backup process computer network connections are hung. In order to restore image, when data backup is done network connection should be refreshed in IE Web browser.

In order to CD backup, insert CD/CD-RW into recorder and enter *CD/DVD BACKUP* menu.

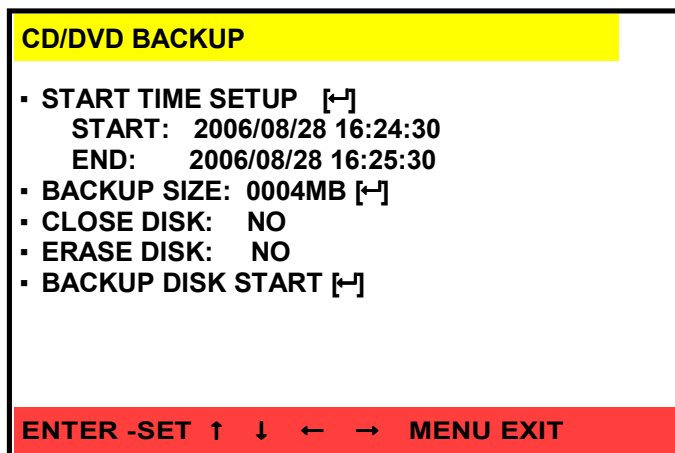

In *START TIME SETUP* position current duration of copied file is displayed

In order to set start time and date of backup record *START TIME SETUP* option should be selected and *ENTER* button must be pressed

Following menu will be displayed on the screen

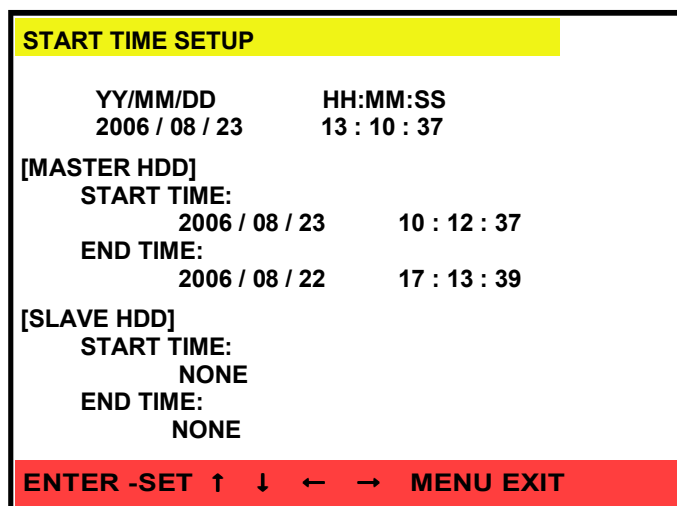

BACK UP

Start time and date of the copy should be set using cursor buttons. Please, follow steps, regarding recorded data search, described in chapter 6. If **ENTER** button is pressed system starts searching for available data. If data from selected range are available on HDD following message will be displayed

SEARCH TIME OK!

And **CD/DVD BACKUP** menu will be returned

Otherwise following message will be displayed

SEARCH TIME NOT FOUND!

when copy start is established, total size of copied file must be defined. System will set closing time and data, regarding to previous settings.

When end position is set (date, time and backup size will be highlighted with yellow color) it is possible to select backup size, expressed in MB, using cursor buttons ◀ ▶. Changes can be adjusted by each 1MB. System currently updates backup end time, according to adjusted backup size. For quick backup size adjustment, press **ENTER** button. Single number will be highlighted with yellow color. using cursor buttons ▲ ▼ required MB value can be set. Value change can be adjusted using cursor buttons ◀ ▶. In order to leave this menu **ENTER** button must be pressed.

NOTICE: if selected data size exceeds CD capacity, backup process will be cancelled when CD capacity is filled.

In **CLOSE CD** position CD section can be closed or not when backup process is completed. Please, keep it in mind that „opened” CD can be invisible for some CD-ROMs. .

When using CD/RW there is possibility to erase CD capacity before backup. In order to erase CD-RW, **CD-RW ERASE** position should be set to ON.

When all settings are adjusted backup process can be initiated. In order to initiate CD backup **BACKUP DISK START** should be selected and **ENTER** button should be pressed.

During backup process progress information is displayed (in percentage and MB). System will inform also when backup process is completed. When backup is completed CD-ROM tray will be automatically opened.

Please do not press any buttons during backup.

If CD backup is unavailable, using inserted CD, following message will be displayed:

ERROR MEDIA DISK

NOTICE: in case of backward system clock change (e.g. during summer/winter time change) it is unavailable to select backup records from hour, that will be repeated for the same day. In this case only flash memory backup is available.

ALARM INPUTS AND OUTPUTS CONNECTION

8. ALARM INPUTS AND OUTPUTS CONNECTION

NV-DVR1104/CD, NV-DVR1108/CD, NV-DVR01116/CD digital multiplexers are equipped accordingly with 4, 8 or 16 alarm inputs, which allow to connect external devices.

When external alarm function is active (chapter 6.5) alarms will be registered in Event Registry, even if recording mode is set to off.

In order to automatically switch the device to alarm recording mode manual or schedule recording must be initiated.

Junction for cable connection is equipped with handy, removable clamp junctions terminal. On this terminal also alarm output is placed. For detailed terminal description please view the image below.

PIN	FUNCTION
1	ALARM INPUT 1
2	ALARM INPUT 2
3	ALARM INPUT 3
4	ALARM INPUT 4
5	ALARM INPUT 5
6	ALARM INPUT 6
7	ALARM INPUT 7
8	ALARM INPUT 8
9	ALARM INPUT 9
10	ALARM INPUT 10
11	ALARM INPUT 11
12	ALARM INPUT 12
13	ALARM INPUT 13
14	ALARM INPUT 14
15	ALARM INPUT 15
16	ALARM INPUT 16
17	-----
18	-----
19	-----
20	GND
21	GND
22	ALARM RESET
23	ALARM OUTPUT N.C.
24	ALARM OUTPUT COM
25	ALARM OUTPUT N.O.

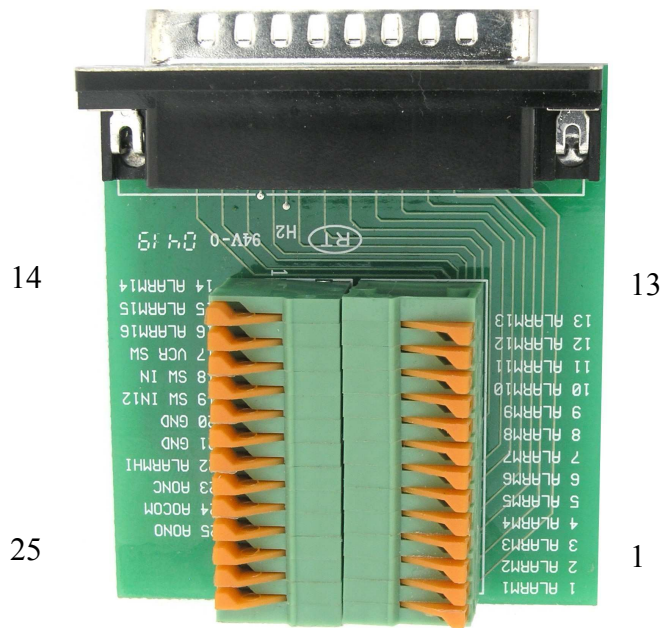

ALARM INPUTS AND OUTPUTS CONNECTION

Alarm inputs operate in TTL/CMOS standard, therefore accept appearing 5 volts or ground shorting. Alarm Input will be activated when low or high state appears, according to *ALARM* menu settings.

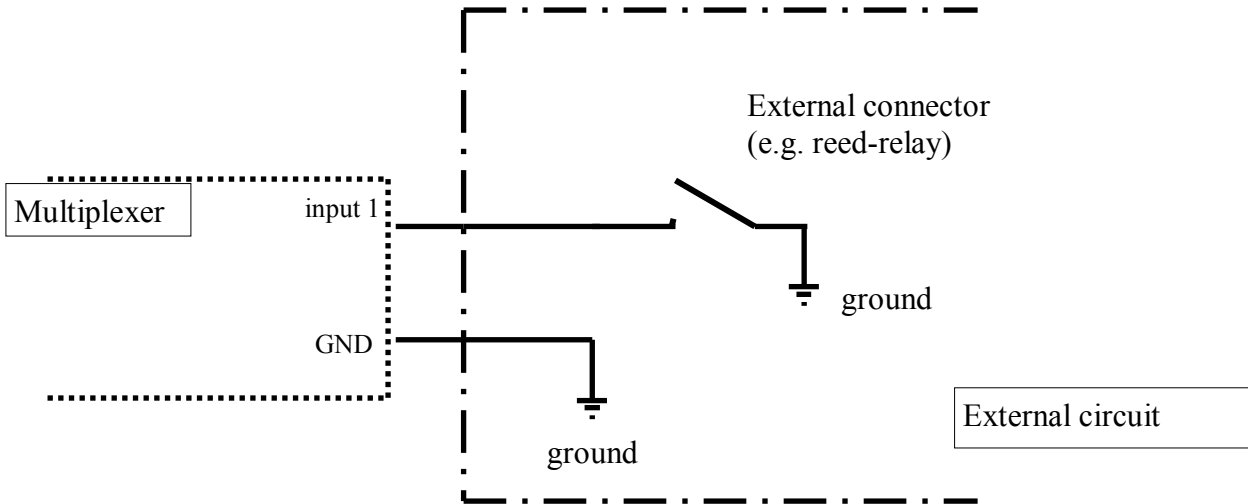

eng

Notice: both alarm inputs and outputs are not protected against high voltage induction. Alarm inputs and outputs should be protected against discharges, which may damage them.

NV-DVR1104/CD, NV-DVR1108/CD and NV-DVR1116/CD are equipped with alarm outputs which allow for external devices control. Both outputs modes: NO and NC are available. Alarm output load current can not exceed 100mA. It is possible to connect e.g. LED in order to create circuit, as it is shown on the scheme below. Additional circuit, with e.g. additional relay, should be used if high power consumption devices are connected to alarm output.

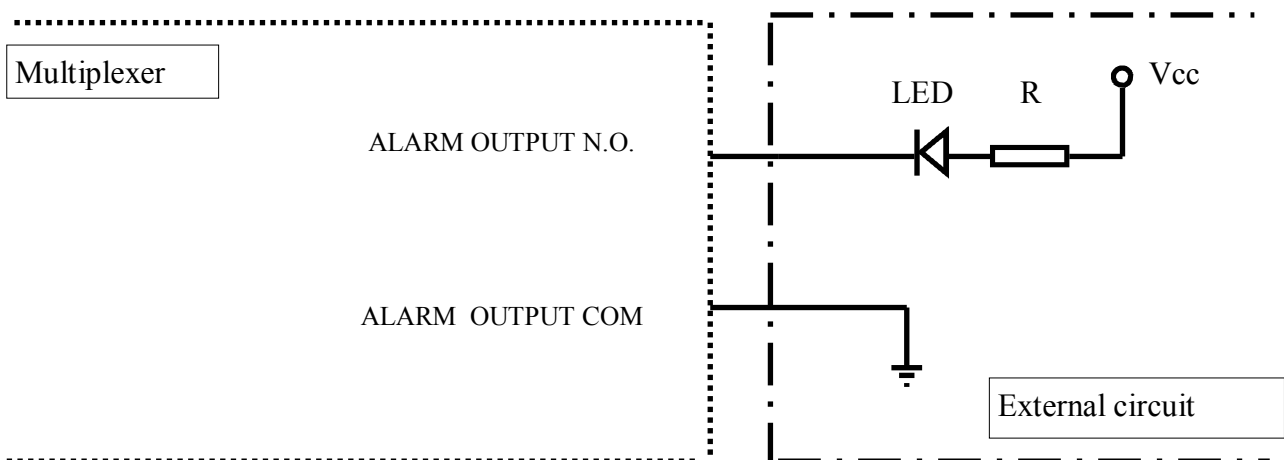

SPEED DOME CAMERA - CONNECTION AND CONTROL

9. SPEED DOME CAMERA CONNECTION AND CONTROL

NV-DVR1104/CD, NV-DVR1108/CD and NV-DVR1116/CD digital multiplexers allow to control up to 4, 8, 16 cameras (speed dome, standard digital and optical zoom cameras) equipped with RS-485. Control lines are connected in a “daisy chain” way. Camera controlled by user by buttons placed on front panel or by utilizing net software. (description in chapter 12).

Caution: camera control via Network is inactive during records playback.

For proper operation each speed dome camera must have unique system address. Following rule should be applied: camera with address 1 is connected to video input nr 1, camera with address 2 connected to channel 2 and so on.

Control is done by Novus-C, Novus-C1, Novus-C2 or Pelco-D protocols.

Notice: All cameras in the system should have identical protocol and transmission speed (please view speed dome camera manual).

Camera connection description applies to Novus camera connections. In order to connect cameras of other producers, technical department should be contacted and user should familiarize himself with specific camera manual.

9.1 Novus speed dome Camera Connection

Speed dome camera control lines are connected in a “daisy chain” way with the use of twisted pair cable (UTP 5th class). The maximum length of line can not exceed 1200m.

The telemetry control signals are lead to junction DB9 with the symbol *RS232/485*

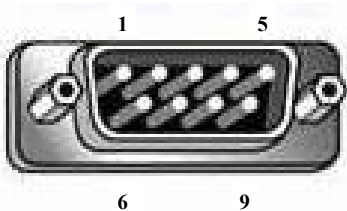

Pin 9 RS-485 Tx + lead
Pin 8 RS-485 Tx - lead

in order to facilitate cable connection clamp junctions terminal is attached

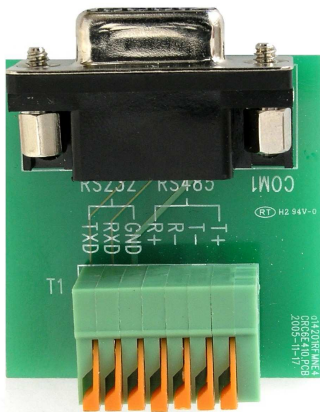

clamp T+ should be connected with RX + / D+ in the camera
clamp T- should be connected with RX - / D- in the camera

SPEED DOME CAMERA - CONNECTION AND CONTROL

An example of CCTV system based on NV-DVR1116/CD and Cama series camera

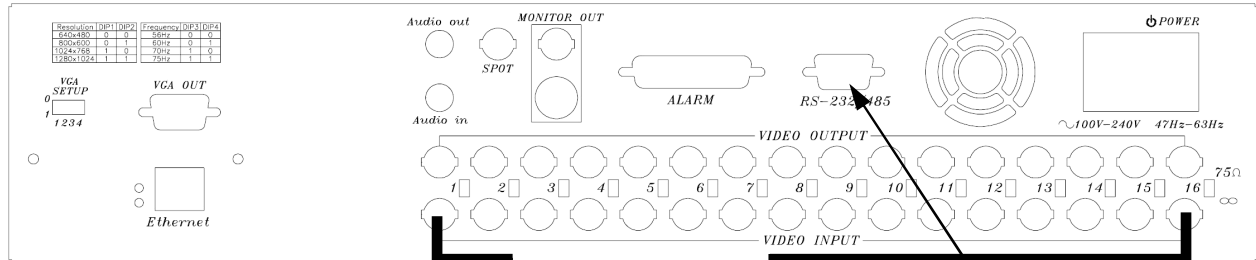

eng

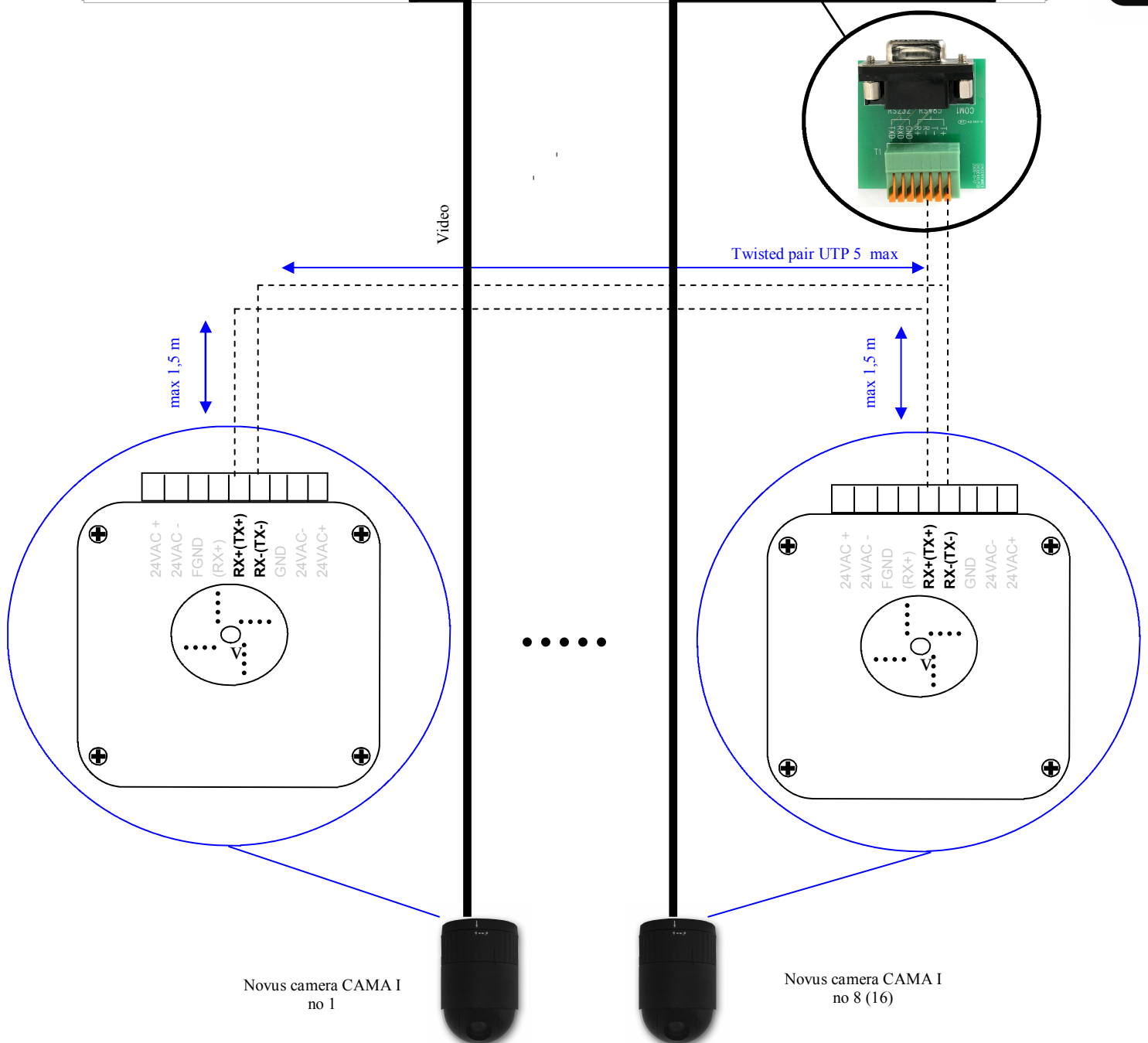

SPEED DOME CAMERA - CONNECTION AND CONTROL

9.2 Camera Control

In order to enter camera control mode, select specific camera in „live mode” and press **SEL** button.

PTZ inscription displayed in right upper corner means that multiplexer operates in camera control mode and some buttons are now active as a Speed Dome control buttons:

▲ ▼ ▶ ◀ - cursors allows to camera tilt up , down and pan right, left

PLAY - zoom in (zoom)

R.PLAY - zoom out (zoom)

STOP - first patrol activation

Control is done in a „step” way, which means that each button press will execute one step of particular function e.g. pan move.

When **MENU** button is pressed special PTZ menu will appear. Using this menu one of six camera pan and tilt levels may be defined. Each level represents how “long” the “step” is. The higher level number is, the bigger elementary movement is done.

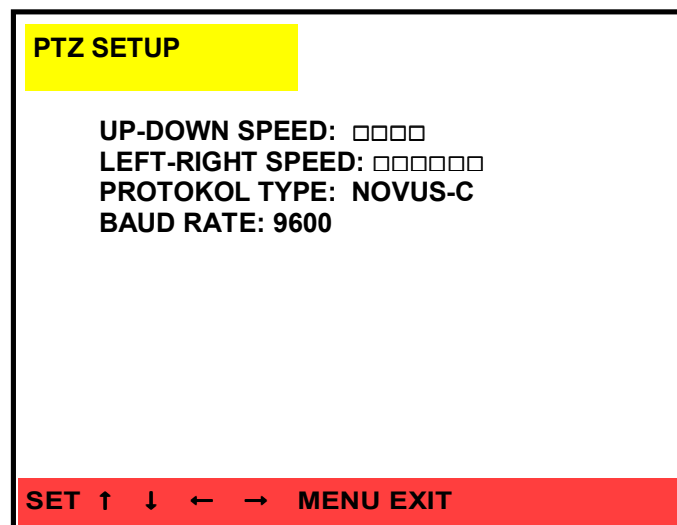

PTZ SETUP is used to set protocol and transmission speed (identical for all cameras). Following protocols can be selected: Novus-C, Novus-C1, Novus-C2, Pelco-D. following transmission speeds can be selected: 2400, 4800, 9600, 19200 BPS.

In order to exit PTZ menu, **MENU** button should be pressed.

In order to exit camera control mode **SEL** button should be pressed. Sign **PTZ** will disappear from the screen and multiplexer will return to normal working mode (buttons will activate standard functions)

IR REMOTE CONTROL

10. IR REMOTE CONTROL

NV-DVR1104/CD, NV-DVR1108/CD and NV-DVR1116/CD multiplexers are equipped with IR remote control.

Remote control allows to control only one device. If more than one device are situated within remote control range all of them will be controlled.

Remote control range is approximately 7 m and depends on battery level. Operating angle regarding device front panel is approximately 30°.

The view of IR remote control:

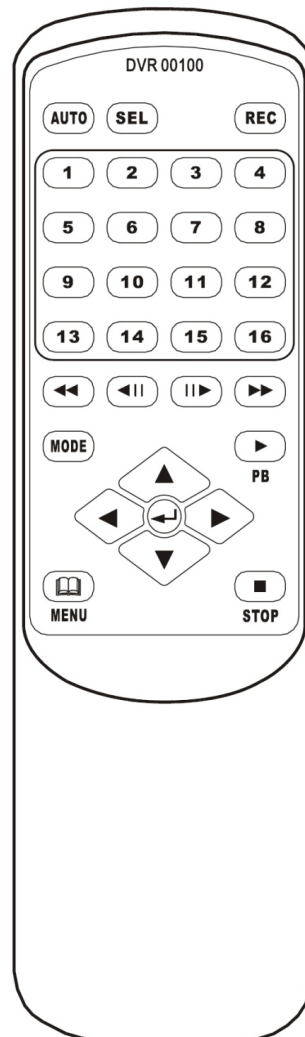

Remote control buttons are described in the same way as multiplexer's front panel buttons. Their function stay also the same. The only difference is that it is not possible to change display mode using cursor buttons; these buttons can be used to toggle within menu positions. In order to switch display mode *MODE* button should be pressed. *MODE* button allows also to zoom-out while PTZ mode (substitute of *R.PLAY* button on the front panel)

eng

KEYBOARD CONTROL

11. KEYBOARD CONTROL

NV-DVR1104/CD, NV-DVR1108/CD and NV-DVR1116/CD multiplexers can be remotely controlled from the level of NV-KBD60 or NV-KBD30 system keyboards. It is possible to control up to 10 multiplexers using one system keyboard. Daisy chain main line can not exceed 1200m. and branches from the main line can not exceed 1,5m.

NV-KBD30 system keyboard is economic solution designed for multiplexer's remote control. Keyboard is equipped with buttons, which are used to control all multiplexer's functions. Some of multiplexer's functions are realized as a two keys combination. Keyboard is equipped with LED display, that informs about address of current controlled multiplexer and last sent commands.



NV-KBD60 system keyboard is technically advanced device designed for multiplexer's and camera's remote control. This control is done independent from the front panel control, that was described in chapter 8. NV-KBD60 allows for fully usage of all PTZ cameras functions.

Keyboard button's descriptions and functions are similar to multiplexer's. All multiplexer's functions are available from the level of NV-KBD60. Keyboard is equipped with LCD display, that informs about multiplexer functions, transmission parameters, etc.



In order to connect DVR with a keyboard use the same clamp junction terminal described in chapter 9 but this time use adequately *R-* and *R+* junctions.

Further information, concerning system keyboards description, can be found in attached user's manual.

NETWORK CONNECTION FEATURE

12. NETWORK CONNECTION FEATURE

NV-DVR1104/CD, NV-DVR1108/CD, NV-DVR1116/CD digital multiplexers allow network connection option utilizing TCP/IP protocol.

Network connection is realized via Internet Explorer browser.

Up to 4 simultaneous connection are possible in "live" mode. Each user can select different camera view or screen split. In case of "playback" mode each user (also up to 4) can also select different camera view or screen split, but all of them see the same recordings (form the same time). Changing the playback time takes influence on each client's applet currently connected.

Warning: NOVUS company is not a distributor of server systems, routers, hubs, and other net devices which have influence on proper net working. Net user or network administrator is responsible for configuration propriety of mentioned devices .

eng

12.1 Computer Hardware Requirements

Processor	Intel® Pentium® 1GHz (or higher)
RAM memory	128MB
Internet browser	Internet Explorer 5.0 (or higher), with Java script set as active
Other devices required	Graphic Card, AGP x 4, 16MB
Operating System	Microsoft® Windows® 2000 / XP™

NETWORK CONNECTION FEATURE

12.2 Initiating connection

For network connections Microsoft Internet Explorer browser should be used.

Multiplexer IP address, which was set previously in network settings, should be input in the browser address bar. If selected communication port is different than 80, after address space, colon and port number must be typed. For example:

http://192.168.2.128 :100

If typed address is correct and target device is available, following window will be displayed



Default user name: *admin*, default password: *admin*. Because of security reasons it is strongly recommended to change default values and memorized new ones.

During connection applet is downloaded from the device. This applet provides all Multiplexer network functions.

Network interface should appear after a while.

Depending on Windows security settings it might be necessary to accept unknown for system Active X format (click *Install*) or change IE security settings.



NETWORK CONNECTION FEATURE

12.3 User Interface view

The view of software window in display mode (after login *admin* account)



eng

The view software window in setting mode

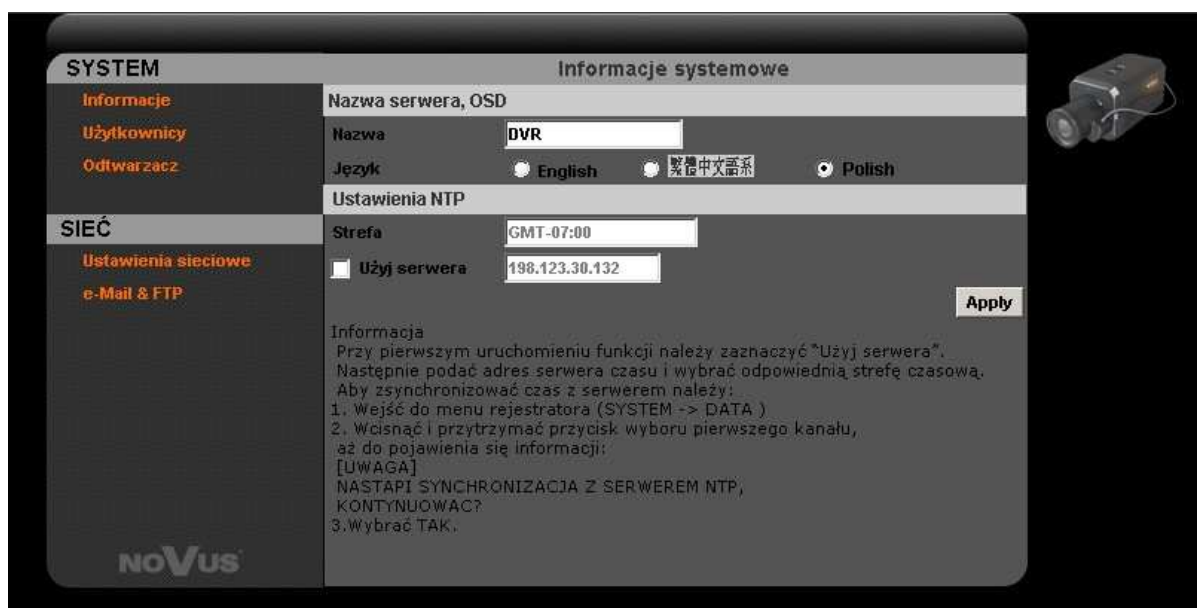

NETWORK CONNECTION FEATURE

12.4 Display settings

When network connection is indicated camera images and software icons will be displayed on the screen.

Notice: only cameras with network display mode available, are visible (chapter 4.8).

 **LIVE** *LIVE* icon displayed in left bottom corner informs that device operates in „live” mode

 **OFF** *OFF* inscription, instead of „LIVE” icon, will be displayed when network is disconnected (e.g. because of data backup). In order to indicate network connection refresh connection in Internet Explorer browser

Camera title is displayed in left upper corner of camera window.
In order to toggle between display modes following icons should be used



in order to select (display) specific camera, left mouse button should be clicked twice on the image of required camera. Each additional mouse click will restore previous display mode.

If this icon  is clicked images from all cameras will be displayed on the full screen. Additional mouse button click restores normal display mode

System clock, that network connection refers to, is constantly displayed in the bottom of the window.

Network applet allows to monitor events in „live” mode. If motion detection or external device alarm occurs, *M* and/or *A* inscription will be displayed in the right bottom corner of camera image.



This information is displayed till manual cancellation. User will be informed about the event, even if event was missed.

In order to delete the event right mouse button should be clicked on camera image and *Clear Event* option should be selected.

12.4.1 Saving images in „live” mode

It is possible to save required image, as a JPEG or AVI file, during display in „live” mode.

In order to save specific image from camera as a static JPEG file, right mouse button should be pressed on camera image and *SAVE IMAGE* option, from displayed menu, should be selected. Then destination location should be selected.

Default file name includes channel number, of saved camera image.

NETWORK CONNECTION FEATURE

In order to save camera image as a video sequence, right mouse button should be clicked on required camera image and *Rec to AVI* option, from displayed menu, should be selected. Following menu will be displayed on the screen:

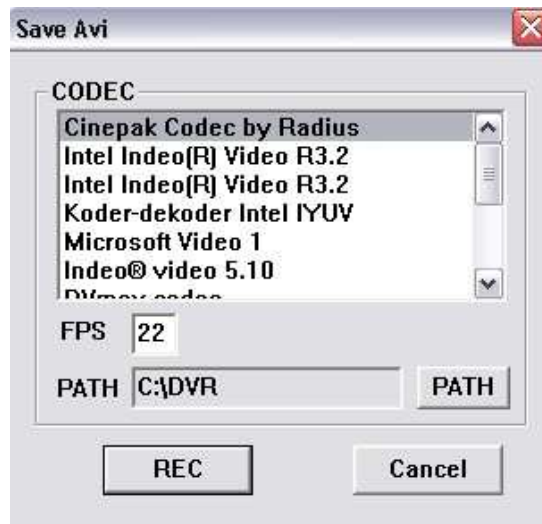

In *CODEC* position one of available video codecs should be selected. According to codec type and settings, various size and quality of AVI file will be received.

In *FPS* bar, please input frames per second quantity of saved file. In order to avoid excessive file size FPS should be suitable for current playback speed.

In *PATH* bar AVI file access path should be selected.

When all settings are set, *REC* button should be pressed to initiate recording of current camera image. Recorded camera title will be displayed in red color. In order to cancel recording right mouse button should be pressed on the camera image and *Stop Rec* option, from displayed menu, should be selected.

In order to playback saved AVI file, video players like e.g. Windows Media Player, can be used. When playback will be run using another PC it is possible that video codec installation, which was used during recording, might be required.

File title includes recorded video channel information and date and time, when file was recorded, e.g.

CH-02-2006_Sep_05_20_42_55.avi

It means that file was recorded from 2 channel, on 5th of September 2006, at 20:42:55.

NETWORK CONNECTION FEATURE

12.4.2 PTZ camera control in „live” mode

If PTZ cameras are connected in the system and all settings, as described in chapter 9, are adjusted properly it is possible to control these cameras via network applet, after connection with multiplexer.

CAUTION: before start controlling cameras via network, all settings and connections should be tested by controlling camera using front panel buttons or IR remote control. If everything works properly it is possible to control cameras via network.

Camera control can be run in various display modes. It is impossible to control camera in full screen display mode, when all control buttons are hidden.

In order to control camera using applet, specific camera should be selected by mouse left button single click on required camera image. Selected camera will be marked with red border. During camera control following buttons, collected in right section, are active

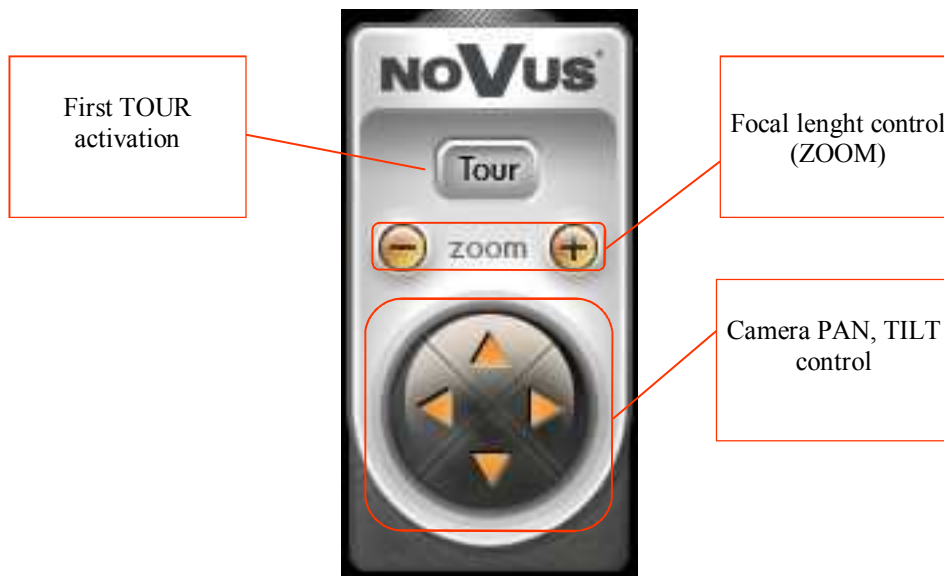

CAUTION: PTZ control is available only with *admin* authorization, in other cases above menu does not appear.

NETWORK CONNECTION FEATURE

12.5 Recorded data search

CAUTION: Playback mode is available only with *admin* authorization.

Except for live display, network applet offers recorded data search. It is possible, as locally, to search for recorded data by date and time and also to playback records.

If icon  is clicked, following search menu will be displayed

Search..... ✖

Time Search

2006-09-05 16:43:24 🔍

EVENT

HDD ▼

Index	Start time	Event	Channel

In *Time Search* bar required date and time should be selected.

In order to start searching by required date and time icon  should be clicked.

SEARCH menu disappears when all cameras are displayed. During records playback in left bottom corner *PLAY* inscription is displayed



NOTICE: Simultaneous local and network playback of different recordings is unavailable. If playback is run simultaneous locally and via network both users will watch records from the same date. Various screen divisions are available.

NOTICE: When one of the network users starts playback all other remote client software switch automatically to the playback mode. In other words, simultaneous connections in "live" and "playback" modes are unavailable.

eng

NETWORK CONNECTION FEATURE

Selection of camera channel and screen division can be done in the same way as in „live” mode. In order to change playback speed and direction, during playback, following icons/buttons should be used.

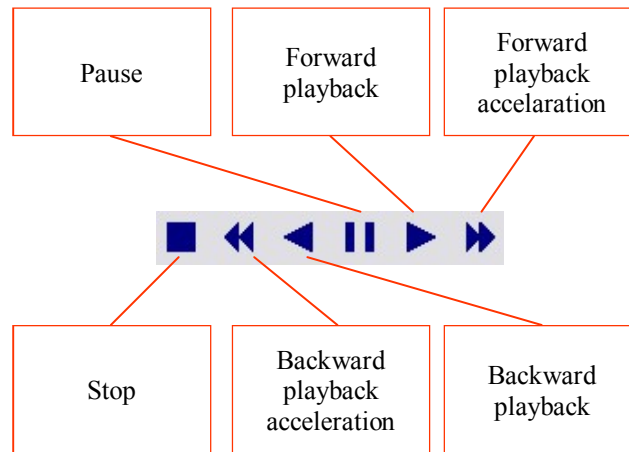

Each additional icon click will switch playback speed as follows x2, x4, x8, x16, x32. In order to proceed to „live” mode, **STOP** icon should be clicked.

Played record time together with playback status (speed and direction) are displayed in the bottom of the screen.

NETWORK CONNECTION FEATURE

In order to playback records connected with the event, Search menu should be entered and required HDD should be selected. Event list from required HDD will be displayed in a while.

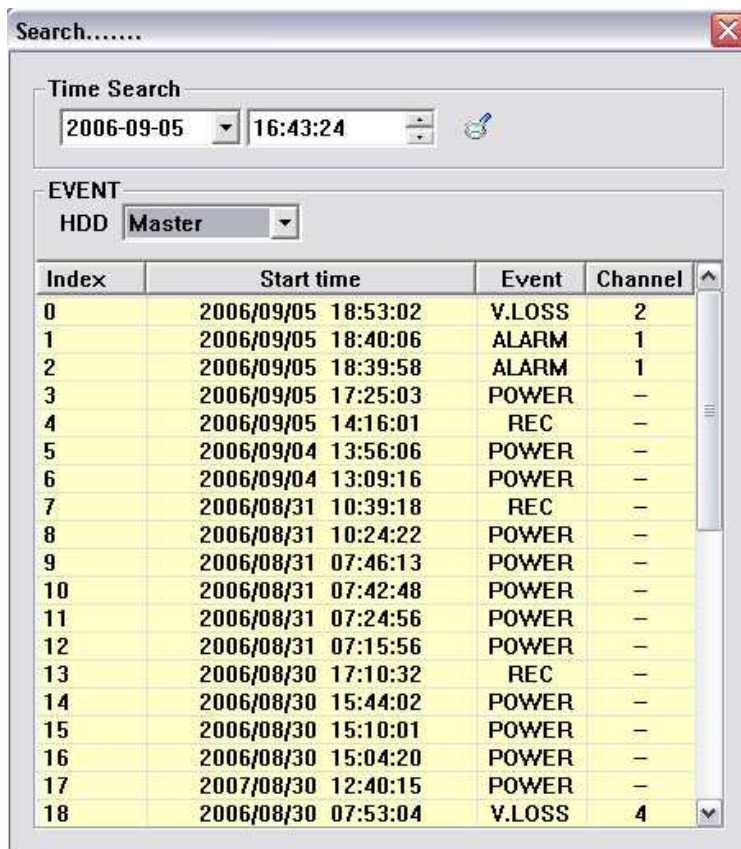

Events are listed in order from the latest to the oldest. Date and time of event occurrence are displayed in Start time column. Event column consists of event type, Channel column consists of channel number.

Event shortcuts description:

V.LOSS - video signal loss

ALARM - external alarm

MOTION - motion detection

POWER - multiplexer Power up

REC - start recording

After double click on the event from the list, Search menu will disappear and camera images will be displayed on the screen. Playback control and saving images can be done in the same way, as described on the previous page.

12.5.1 Saving images while playback mode

It is possible to save images, during playback, as was described in case of Live mode. The procedure is identical as described in chapter 11.4.1.

NETWORK CONNECTION FEATURE

12.6 Software settings

In order to enter software settings click  icon from right upper corner

In order to return back to main window icon  should be clicked.

12.6.1 Software language and Server time settings

In *System information* submenu following settings can be adjusted:

- Software language can be set in *Language* position
- in *NTP Setting* position all settings required at system time synchronization function can be adjusted. When *Set NTP Server* position is selected time server address and time zone can be set.

In order to introduce changes *Apply* button should be clicked.

12.6.2 Users passwords and accounts.

Utilizing *User Management* submenu following settings can be adjusted:

- *Anonymous User Login* position is used to configure if connection with multiplexer should be done with user's login or not. To accept selection click *Setting* button.
- *User Management* position is used to edit users accounts. User's list with their passwords and access levels is displayed in the bottom of the window. *Admin* level is available only for one user. New user name is input in *Username* field and new password is input in *Password* field. In *Confirm* field user's password should be typed twice and *Add/Set* should be clicked. In order to edit users account, highlight user's name from the list and follow all steps described above.

12.6.3 NC Viewer Download

When *Download submenu* is clicked *NC Viewer* file will be downloaded from multiplexer onto PC

12.6.4 IP setting

All network parameters settings are grouped in this tab. The meaning of each parameter was described in chapter 4.8. Any changes can be adjusted using *IP Setting* tab. In order to introduce changes *Apply* should be selected.

NOTICE: When IP address or port has been changed network will be disconnected. Connection should be resumed according to newly adjusted parameters.

eng

NETWORK CONNECTION FEATURE

12.6.5 FTP & e-Mail

FTP & e-Mail submenu is used to apply modification in the FTP server settings (image sending) and e-mails sending from alarm events.

- *Mail Server* - mail server address, which is utilized for sending e-mails
 - Username* - user name required during login to server mail (the e-mail account should be created previously)
 - Password* - user password required during login to server mail
 - Sender Mail* - sender's e-mail address (used for sending e-mails)
 - Receiver Mail* - the receiver's e-mail address
 - Bcc Mail* - second receiver's e-mail address
 - Event Subject* - event title

In order to send e-mail notification *Mail* position should be marked

In order to activate settings *Apply* button should be clicked.

- *FTP Server* - image receiving FTP server address
 - Username* - username required while login to FTP server
 - Password* - user password required while login to FTP server
 - Port* - transmission port
 - Upload Path* - user path, if program designated root folder is different then default, the appropriate user upload path must be entered

In order to send alarm image files FTP option must be marked

In order to activate and save current settings modification *Apply* should be clicked.

BACKUP PLAYBACK

13. BACKUP PLAYBACK

During CD backup or memory flash backup together with records copy, *NC Viewer* file is recorded as a self-extracting *player.exe* file. It allows to playback copied files on every PC with no need of additional software or video codecs installation. This player allows to search for records in HDDs withdrawn directly from multiplexer. Played records can be recorded on PC.

NC Viewer player is also available on CD-ROM or might be obtained via network from DVR.

Computer hardware requirements for *NC Viewer* are the same as described in chapter 10

CAUTION: *NC Viewer* does not operate with audio signal.

13.1 View of *NC Viewer* software window

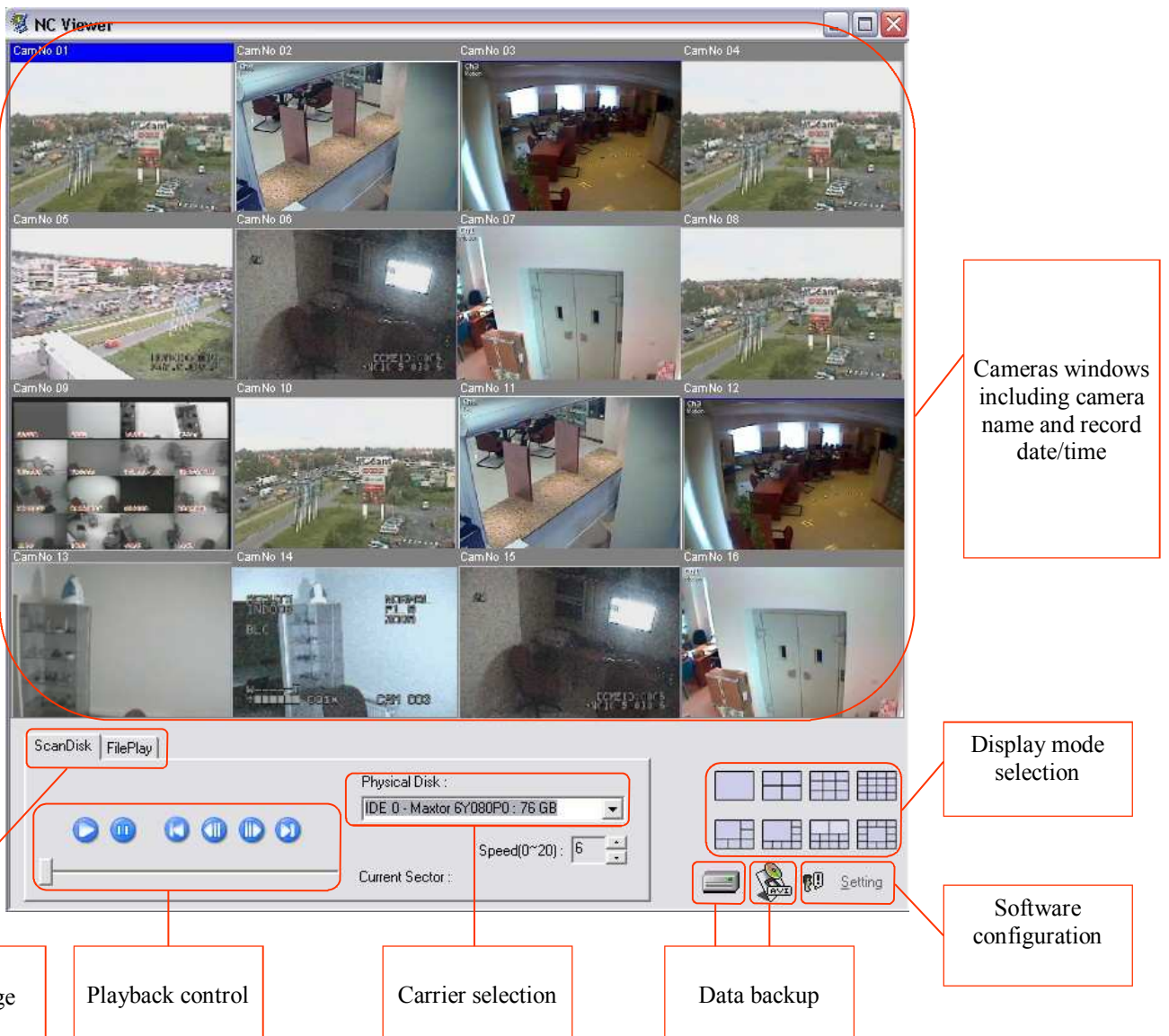

BACKUP PLAYBACK

13.2 Flash memory backup playback

When USB flash memory is connected to PC port, please verify if it has been properly detected .

FilePlay tab should be selected.



Opening file icon should be clicked. 

Search for flash memory and select required copy file.

After a while required file will be analyzed and ready for playback.

Vertical status bar informs on file analyze progress.

When file is loaded (status bar disappears) playback can be activated.

Interface elements functions are described below:

- Control icons

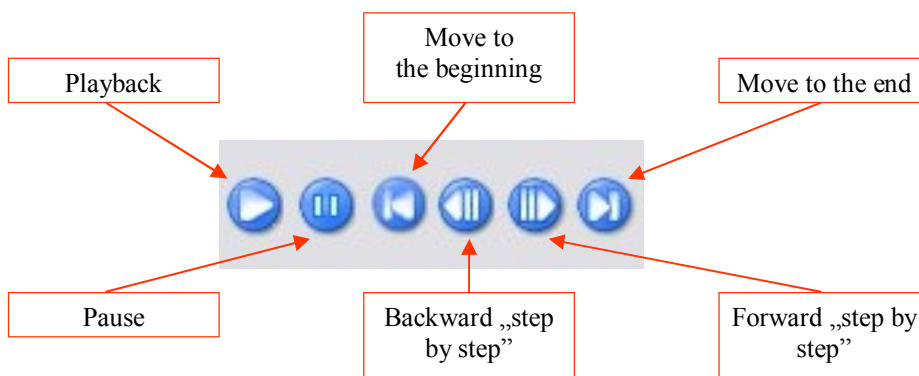

- Playback status bar

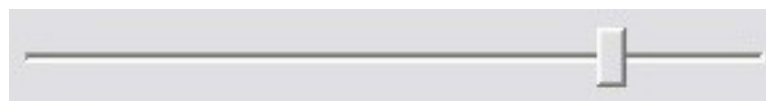

- Playback speed adjustment; 0-20 range

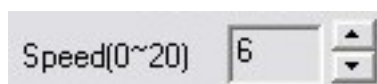

BACKUP PLAYBACK

Records range and current playback progress information are displayed above the playback speed controller. In an example shown below the file includes records from 2006 31 August 10:09:38 to 2006 31 August 10:28:45, and currently records, from 2006 31 August 10:28:04, are played.

From : 06 Aug 31 10:09:38
 To : 06 Aug 31 10:28:45
 Current : 06 Aug 31 10:28:04

eng

Display screen change is available during playback using following icons:

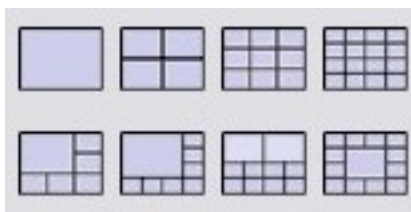

In some screen divisions (e.g. 2*2) each additional icon press will display following camera's groups: 1234, 5678, etc.

Double click on camera image toggles between full screen mode and last displayed screen mode.

It is possible to define maximum cameras quantity, depending on multiplexer model i.e. for NV-DVR1108/CD 11 and 16 screen division can be locked. In order to define maximum cameras quantity **Setting** menu should be entered and required channel number should be set in **Max Channel** position .

13.3 Flash memory backup converting to JPEG or AVI file format

When playback is run it is possible to capture single JPEG images or AVI sequences.

In order to capture single image, right mouse button should be clicked on the camera image, **Save "CamNo0x" Image** position should be selected and save path should be defined. If **Save "Image all..."** option is selected it is possible to capture single images from all cameras. JPEG file title consists of recorded channel information. JPEG files can be opened using any graphic program or graphic files browser.

In order to capture video sequence as AVI file **Settings** menu should be entered and in **AVI Frame/s** position required frames per second quantity, according to multiplexer's recording speed, should be defined. Additionally one of available video codecs, from **AVI Codec list**, should be selected. According to video codec type and settings various AVI file quality and size will be received.

BACKUP PLAYBACK

Subsequently following icon should  be clicked.

Camera selection and AVI file save path menu will be displayed.

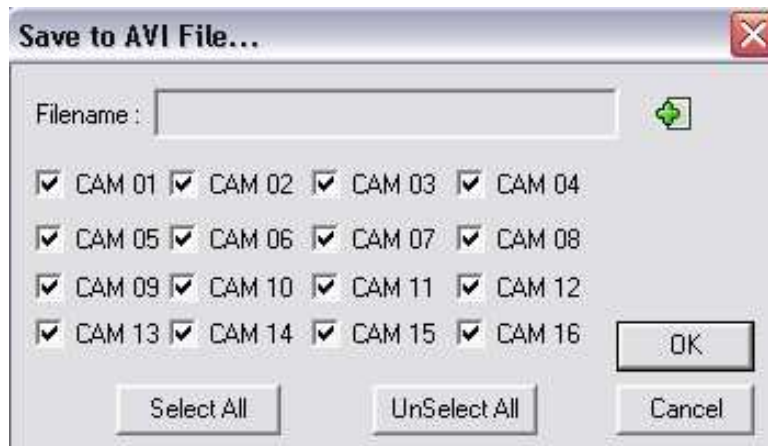

Filename position is used to select AVI file save path (when green „plus” icon is clicked). *CAM 01* to *CAM 16* positions are used to select backup channels. *Select All* and *UnSelect All* options are used for quick selection or de-selection of all 16 channels.

When *OK* is clicked menu will be closed and system will wait to initiate playback and AVI file recording.

In order to initiate these processes icon  should be clicked..

During AVI file recording, playback will be run with lower playback speed.

Icon  is used for any time conversion stopping.

CAUTION: Recorded AVI file's resolution is 320x220, even if original record resolution is different.

Recorded AVI file can be played using any video player, like e.g. Windows Media Player. Video codec installation might be required when file will be played on different PC than PC where was recorded.

File title consists of video channel information, whereof record was done, e.g.

capture_CH-01-1157113435.avi

means channel no 1 record.

BACKUP PLAYBACK

13.4 Flash memory backup printing

When playback is run it is possible to print played images, using system printer directly, with no need of use additional software.

In order to print single image right mouse button should be clicked on the camera image and *Print "CamNo 01" Image* should be selected. Following window will be displayed on the screen:

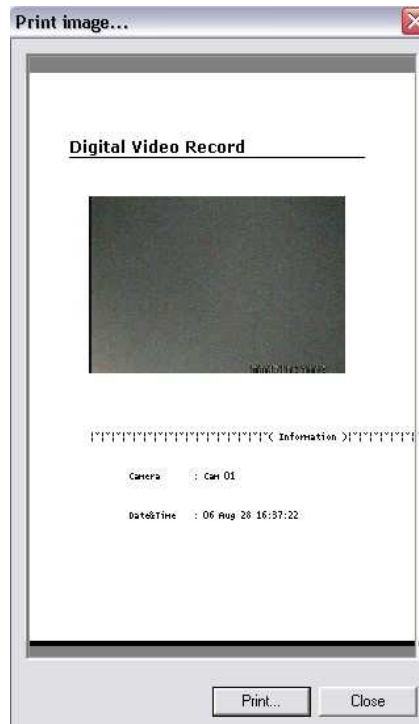

Together with camera image, video channel and printing time information, will be printed.

When *Print...* position is clicked printer settings menu will be displayed. When *Close* is selected menu window is closed.

BACKUP PLAYBACK

13.5 CD backup playback

When CD with copied records is inserted to PC CD drive, *FilePlay* tab should be selected.

File opening icon  should be clicked and required file should be selected.

After a while, depending on data quantity, required file will be analyzed and prepared for playback. Playback should be run following steps described in chapter 13.2.

13.6 CD backup converting to JPEG or AVI file format

Converting procedure is similar to procedure regarding flash memory, which is described in chapter 11.3.

13.7 CD backup printing

Printing procedure is identical as procedure regarding flash memory, which is described in chapter 13.4

13.8 Playback from HDD withdrawn directly from multiplexer.

NC Viewer software allows for HDD review and PC data backup.

In order to conduct this process, multiplexer should be turned off, swappable bay should be opened and withdrawn. HDD should be connected to PC directly via IDE channels or using USB port. Than *NC Viewer* can be activated.

CAUTION: before HDD connection (or disconnection) directly to IDE channel PC must be turned off

NOTICE: if necessary HDD operation mode should be configured using HDD jumpers. Do not forget to restore settings before HDD connection to multiplexer.

In order to initiate playback from multiplexer's HDD, *ScanDisk* tab should be selected in *NC Viewer* program. From displayed *Physical Disk* menu, HDD consisting of required records should be selected. Each HDD capacity is displayed next to HDD title. HDD title, which name starts from *IDE 0* refers to PC system HDD. HDD connected via USB port is defined as *USB Device*.

During records playback, icons-buttons and speed controller, similar to described in chapter 13.2, should be used.

Information concerning HDD current sector, whereof records are played, is displayed during records playback

BACKUP PLAYBACK

13.9 Creating records copy

It is possible to copy HDD contents onto PC HDD, that will be used for further records playback. Copied record will be saved in its own format as a file with **.dvr* extension. This file format allows for further playback in any display mode (one file consists of records from all channels). This file format does not occupy as much HDD capacity as AVI file.

Before backup initiating, software *Settings* menu should be entered and save path for copied records should be selected. Default save path is *c:/DVR*.

In order to create HDD records copy icon  should be clicked and playback should be initiated.

During AVI file saving process playback will be run with lower playback speed. Icon showed above allows also to stop backup process any time and every time when playback is completed.

File name includes information about date and time, when file was created, e.g:

20060904_120616.dvr

13.10 Event files conversion.

As was mentioned before digital multiplexers NV-DVR1104/CD, NV-DVR1108/CD and NV-DR1116/CD allow for alarm e-mails sending and events backup on FTP Server. In both cases user receives single files in **.nch* format. These files can be played singly using *NC Viewer* player. More effectively method of events playback (especially from FTP Server) is integration of bigger files quantity in one continuous file.

In order to convert **.nch* files into one continuous events record icon  should be clicked, folder including **.nch* events records should be selected and save path of resultant file should be selected.

NOTICE: resultant file can not be saved at the same save path as **.nch* files.

At this moment *event.nch* default file name change is available

Merged event file can be played and converted following steps described in 11.2 and 11.3 chapters.

NOTES

eng

NOVUS[®]

NOVUS Security Sp. z o.o.

ul. Puławska 431, 02-801 Warszawa
tel.: (22) 546 0 700, fax: (22) 546 0 719
www.novuscctv.com

2007-01-25