

AVN806 IR NETWORK CAMERA SERIES OPERATION GUIDE

Please read instructions thoroughly before operation and retain it for future reference.

IMPORTANT SAFEGUARD



All lead-free products offered by the company comply with the requirements of the European law on the Restriction of Hazardous Substances (RoHS) directive, which means our manufacture processes and products are strictly "lead-free" and without the hazardous substances cited in the directive.



The crossed-out wheeled bin mark symbolizes that within the European Union the product must be collected separately at the product end-of-life. This applies to your product and any peripherals marked with this symbol. Do not dispose of these products as unsorted municipal waste. Contact your local dealer for procedures for recycling this equipment.



This apparatus is manufactured to comply with the radio interference requirements.

Federal Communications Commission Interference Statement

This equipment has been tested and found to comply with the limits for a Class B digital service, pursuant to Part 15 of the FCC rules. These limits are designed to provide reasonable protection against harmful interference in a residential installation.

Any changes or modifications made to this equipment may void the user's authority to operate this equipment. This equipment generates, uses, and can radiate radio frequency energy. If not installed and used in accordance with the instructions, may cause harmful interference to radio communications. However, there is no guarantee that interference will not occur in a particular installation. If this equipment does cause harmful interference to radio or television reception, which can be determined by turning the equipment off and on, the user is encouraged to try to correct the interference by one or more of the following measures:

- Reorient or relocate the receiving antenna.
- Increase the separation between the equipment and receiver.
- Connect the equipment into an outlet on a circuit different from that to which the receiver is connected.
- Consult the dealer or an experienced radio/TV technician for help.
- FCC Caution: Any changes or modifications not expressly approved by the party responsible for compliance could void the user's authority to operate this equipment.
- All external cables connecting to this basic unit must be shielded.
For cables connecting to PCMCIA cards, see the option manual or installation instructions.

This device complies with Part 15 of the FCC Rules. Operation is subject to the following two conditions:

- (1) This device must not cause harmful interference, and
- (2) This device must accept any interference received, including interference that may cause undesired operation.

Trademark Acknowledgements

iPad® & iPhone® are the registered trademarks of Apple Inc.

Android™ is a trademark of Google Inc. Use of this trademark is subject to Google Permissions.

Microsoft®, Windows® & Internet Explorer® are registered trademarks of Microsoft Corporation in the United States and/or other countries.

Disclaimer

We reserve the right to revise or remove any content in this manual at any time. We do not warrant or assume any legal liability or responsibility for the accuracy, completeness, or usefulness of this manual. The content of this manual is subject to change without notice.

This product doesn't have a standby / off mode.

MPEG4 Licensing

THIS PRODUCT IS LICENSED UNDER THE MPEG4 VISUAL PATENT PORTFOLIO LICENSE FOR THE PERSONAL AND NON-COMMERCIAL USE OF A CONSUMER FOR (i) ENCODING VIDEO IN COMPLIANCE WITH THE MPEG4 VISUAL STANDARD ("MPEG-4 VIDEO") AND/OR (ii) DECODING MPEG4 VIDEO THAT WAS ENCODED BY A CONSUMER ENGAGED IN A PERSONAL AND NON-COMMERCIAL ACTIVITY AND/OR WAS OBTAINED FROM A VIDEO PROVIDER LICENSED BY MPEG LA TO PROVIDE MPEG4 VIDEO. NO LICENSE IS GRANTED OR SHALL BE IMPLIED FOR ANY OTHER USE. ADDITIONAL INFORMATION INCLUDING THAT RELATING TO PROMOTIONAL INTERNAL AND COMMERCIAL USES AND LICENSING MAY BE OBTAINED FROM MPEG LA, LLC. SEE [HTTP://WWW.MPEGLA.COM](http://www.mpegla.com).

GPL Licensing



This product contains codes which are developed by Third-Party-Companies and which are subject to the GNU General Public License ("GPL") or the GNU Lesser Public License ("LGPL").

The GPL Code used in this product is released without warranty and is subject to the copyright of the corresponding author.

Further source codes which are subject to the GPL-licenses are available upon request.

We are pleased to provide our modifications to the Linux Kernel, as well as a few new commands, and some tools to get you into the code. The codes are provided on the FTP site, and please download them from the following site or you can refer to your distributor:

http://download.dvrtw.com.tw/GPL/076D_Series/arm-linux-2.6.tar.gz

TABLE OF CONTENTS

1. OVERVIEW.....	1
1.1 Product Features.....	1
1.2 Package Content.....	1
1.3 Product Overview.....	1
1.4 Rear Panel.....	1
1.5 External I/O Port.....	2
1.6 Status Indicator.....	2
2. CAMERA ACCESS WITH INTERNET EXPLORER.....	3
2.1 Camera Login.....	3
2.2 Control Panel Overview.....	3
2.3 Digital PTZ (DPTZ) Operations.....	5
2.4 Event Record Search & Playback.....	6
3. CAMERA CONFIGURATIONS.....	7
3.1 System configuration menu.....	7
3.2 Network.....	8
3.2.1 Network.....	8
3.2.2 QoS.....	8
3.2.3 DDNS.....	8
3.2.4 SNTP.....	8
3.2.5 FTP.....	9
3.2.6 MAIL.....	9
3.2.7 Filter.....	9
3.2.8 UPnP / Bonjour.....	10
3.3 Camera.....	11
3.3.1 Camera.....	11
3.3.2 Video.....	11
3.3.3 Color.....	12
3.3.4 Audio.....	12
3.3.5 Advanced.....	12
3.4 Record.....	13
3.4.1 Record.....	13
3.4.2 Record Timer.....	13
3.5 Storage.....	13
3.5.1 Memory.....	13
3.6 Trigger.....	14
3.6.1 Trigger.....	14
3.6.2 Push Video.....	15
3.7 General.....	16
3.7.1 General.....	16
3.7.2 Time.....	16
3.7.3 Server Log.....	17
3.7.4 Online.....	17
3.7.5 Account.....	17
3.7.6 Maintenance.....	18
APPENDIX 1 PRODUCT SPECIFICATIONS.....	20
APPENDIX 2 BIT RATE TABLE FOR REFERENCE.....	21
APPENDIX 3 Q&A.....	23
APPENDIX 4 RECORDING TIME TABLE.....	24

1. OVERVIEW

1.1 Product Features

- Easy **network setup** with your **iPhone / iPad**
- **ONVIF** standard supported to simplify system integration
- **External alarm I/O device** connection
- Microphone & speaker built-in for **audio transmission**
- **Remote Surveillance**
 - **Fully compatibility** on **iPhone & iPad**, and **Internet Explorer®** on **Windows®** operating system
- **1.3 Megapixel** SONY sensor with **HDTV 720p** quality, allowing users to notice minor details more easily

1.2 Package Content

- | | | |
|---|---|---|
| <input type="checkbox"/> Network camera | <input type="checkbox"/> Camera Bracket | <input type="checkbox"/> 3-pin Terminal |
| <input type="checkbox"/> Quick Setup with iPhone / iPad | <input type="checkbox"/> Adapter | |

1.3 Product Overview

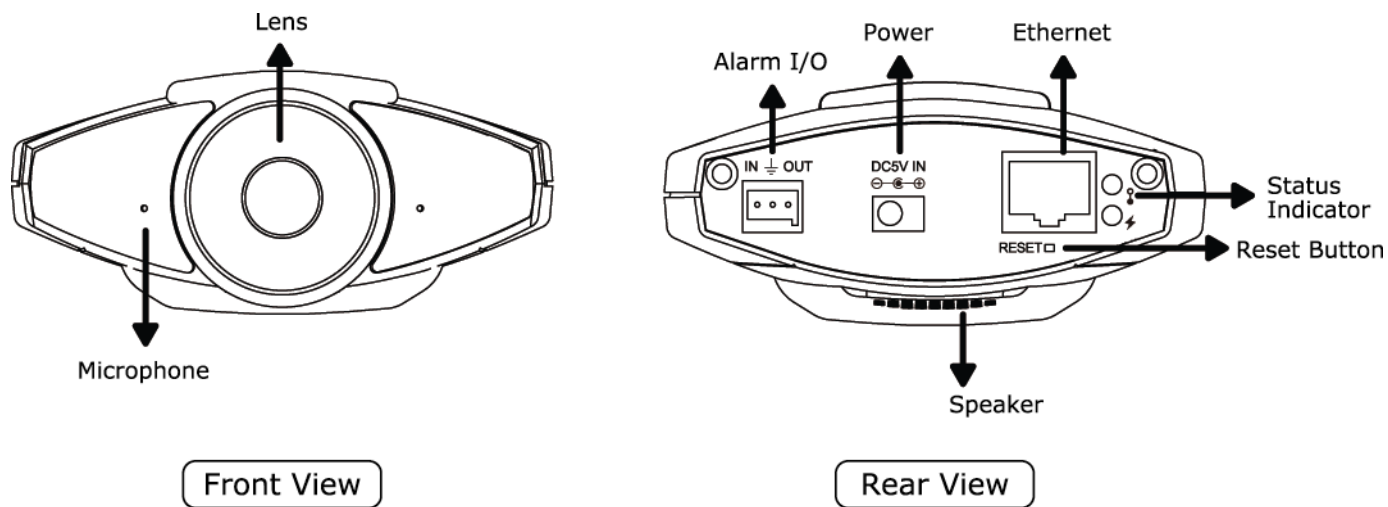

1.4 Rear Panel

Ethernet:	Connect a RJ45 network cable.
Power:	Connect the supplied regulated power supply.
RESET:	With the power connected, press to reset all parameters, including the IP address to factory default settings. The camera will reboot after default reset. Please do not disconnect your camera during the reset process.
Alarm I/O:	A 3-pin I/O terminal is supplied with the camera for external alarm device connection. For details, please refer to "1.5 External I/O Port" at page 2.
Status Indicator	💡 is the indicator for LAN connection, and ⚡ is the indicator for Internet connection. For details, please refer to "1.6 Status Indicator" at page 2.

1.5 External I/O Port

This camera supports external I/O device connection, and a 3-pin I/O terminal is supplied with this camera for easy connection.

Below shows which input on the I/O terminal you should use for wiring when you want to connect an external device to this camera.

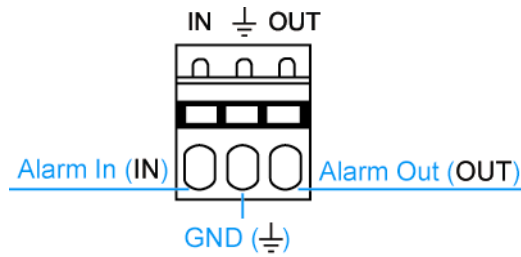

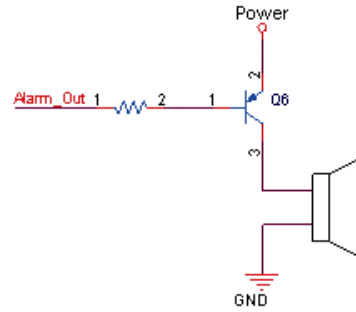

3-pin I/O Terminal



Alarm Out Connection

1.6 Status Indicator

ICON	 LAN connection status	 Internet connection status
System Status		
During powering on	Always on	Always on
Reset default	Blinking (on 250 ms, off 250 ms) ●○○●○○●○○●○○	Always off
Upgrade	Blinking (on 250 ms, off 250 ms) ●○○●○○●○○●○○	Blinking (on 250 ms, off 250 ms) ●○○●○○●○○●○○
Connection Status		
LAN connected	Always on	--
LAN disconnected	Blinking (on 100 ms, off 500 ms) ●○○●○○●○○	--
Internet connected	--	Always on
Internet disconnected	--	Blinking (on 100 ms, off 500 ms) ●○○●○○●○○
3G Connection Error on iPhone / iPad / Android Mobile Device		
3G Connection Setting Uncompleted	--	Blinking (on 5 sec, off 0.5 sec, on 0.5 sec, off 0.5 sec, on 5 sec) ●●●●●○○●●●●●

* LED blinking frequency - ●LED on / ○LED off

2. CAMERA ACCESS WITH INTERNET EXPLORER

This network camera can be accessed via Microsoft® Internet Explorer® and iPhone / iPad / Android mobile devices with our self-developed program “EagleEyes” installed depending on different using situations.

Note: For details about accessing network cameras via iPhone / iPad / Android mobile devices, please refer to <http://www.eagleeyescctv.com>.

Before using the camera, make sure you have configured the network settings, and the network connection is fine.

For network configurations, please refer to:

- **“Quick Setup With iPhone / iPad”** supplied with your camera if you’re using iPhone / iPad, and your network environment is wireless.
- **“ADVANCED NETWORK SETUP”** downloadable from www.surveillance-download.com/user/m317a.swf if your network environment is not wireless.

2.1 Camera Login

Step1: Open your web browser, and key in <http://ipaddress:portnum> in the URL address box.

For example, for the IP address 60.121.46.236 and port No. 888, please key in “<http://60.121.46.236:888>” into the URL address box, and press “Enter”.

Step2: In the login page, key in the user name and password, and enter the security code from the image below if any. Then, click “LOGIN”.

Step3: The wizard is then started.

- To skip the wizard and directly access the camera live view, click “Close”.
- To directly access the camera live view without starting the wizard for the login next time, check “Do not start wizard at login”.









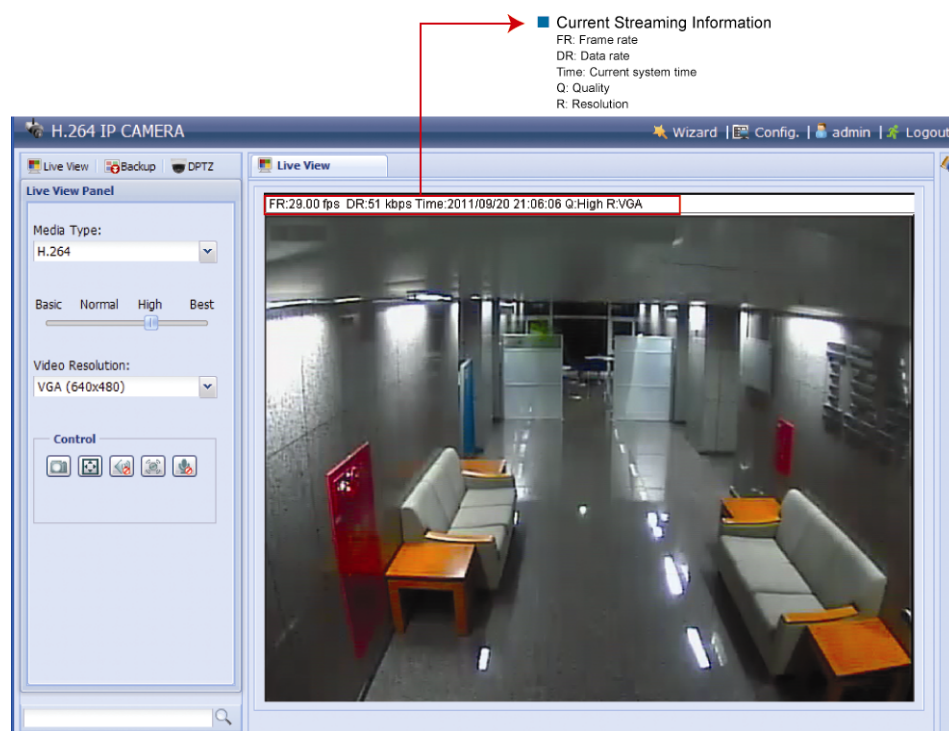



Note: If you’re prompted to install “VLC player”, “Software” or “H264 Streaming Viewer”, please agree to proceed the installation. Or, you might not be able to see the live view properly.

Step5: When the login is successful, the live view is shown.

2.2 Control Panel Overview

Note: The buttons available depend on the model number used and the user level used to log in.

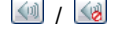

Function	Icon	User Level	Description
Live		Supervisor / Power User / Normal User / Guest	Switch to the live view page.
Backup		Supervisor / Power User	Enter the event record list for video playback. For details, please refer to "2.4 Event Record Search & Playback" at page 6.
DPTZ*		Supervisor / Power User / Normal User	Switch to the DPTZ configuration page. For details, please refer to "2.3 Digital PTZ (DPTZ) Operations" at page 5.
Config.		Supervisor	Switch to the system configuration page, and the functions available for "Supervisor" and "Power User" are different. For details, please refer to "3.1 System configuration menu" at page 7.
Media Type	--	Supervisor / Power User / Normal User / Guest	Select the image player from the drop-down list: <ul style="list-style-type: none"> ■ H.264 / MPEG-4 / Motion JPEG ■ QuickTime <p>QuickTime is Apple Inc.'s multimedia software. You need to have QuickTime installed in your operating system before selecting "QuickTime". When it is selected, you will be promoted to enter the user name and password to access the camera.</p> <ul style="list-style-type: none"> ■ VLC
Quality	--	Supervisor / Power User / Normal User	Click & drag the slider to select the video quality: Basic / Normal / High / Best.
Video Resolution	--	Supervisor / Power User / Normal User	Select the image resolution from the drop list: <ul style="list-style-type: none"> ■ SXGA: 1280 x 1024 ■ HD720P: 1280 x 720 ■ VGA: 640 x 480 ■ QVGA: 320 x 240
Live View Size:		Supervisor / Power User / Normal User	
Full Screen			Click to display the image in full screen. To exit the full screen mode, press "Esc" on your keyboard. <i>This icon appears only when the selected resolution is HD1080P, SXGA, HD720P, VGA or D1.</i>
Double size			The QVGA resolution is resized to fit into the current live view size. <i>This icon appears only when the selected resolution is QVGA or CIF.</i>
Normal Size			The current live view size is the same as the selected resolution. <i>This icon appear only when the selected resolution is SXGA or HD720P or HD1080P.</i>
Fit to screen			The selected resolution is resized to fit into the current live view size. <i>This icon appear only when the selected resolution is SXGA or HD720P or HD1080P.</i>
No Scale			Click and hold the movable square on the left bottom corner of the live view to move <i>This icon appear only when the selected resolution is SXGA or HD720P or HD1080P.</i>
Snapshot		Supervisor / Power User / Normal User	Click to take a snapshot of the current view on a new window. Right click on the picture and re-save it to the location you want.
Audio On / Off		Supervisor / Power User / Normal User	Click to switch the audio-in on / off.
Alarm Out		Supervisor / Power User / Normal User	Click to force your alarm-out device to work. For example, when your alarm device is a buzzer, click this button and your buzzer will start to sound even if there's no alarm event.
Microphone		Supervisor	Click to switch the audio-out on / off.





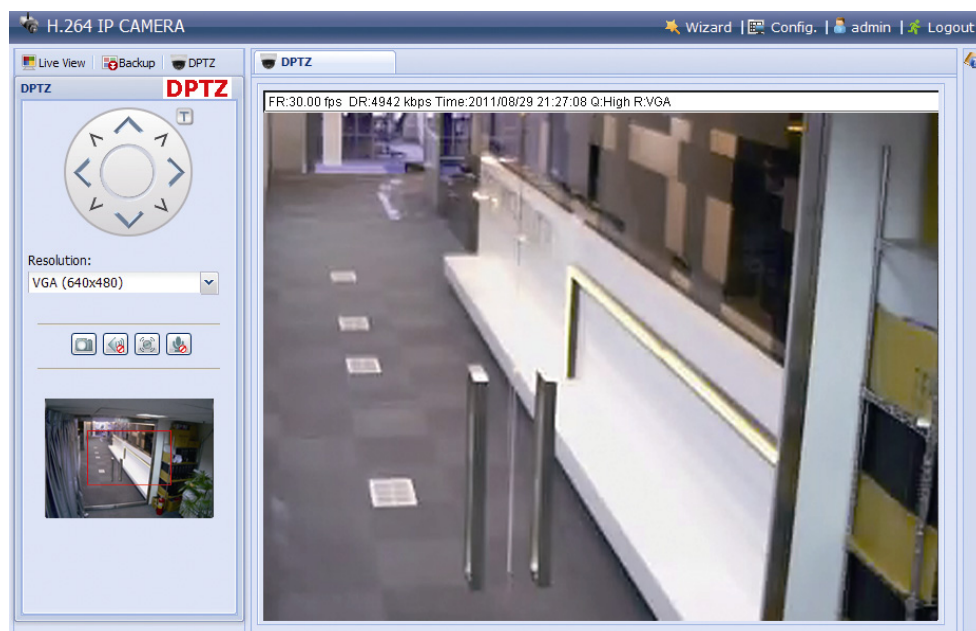

2.3 Digital PTZ (DPTZ) Operations

This camera has PTZ capability, i.e. digital PTZ (hereafter called “DPTZ”), for wide area monitoring.

STEP1: Click “DPTZ” to show the DPTZ control panel.



STEP2: Select the functions when needed:







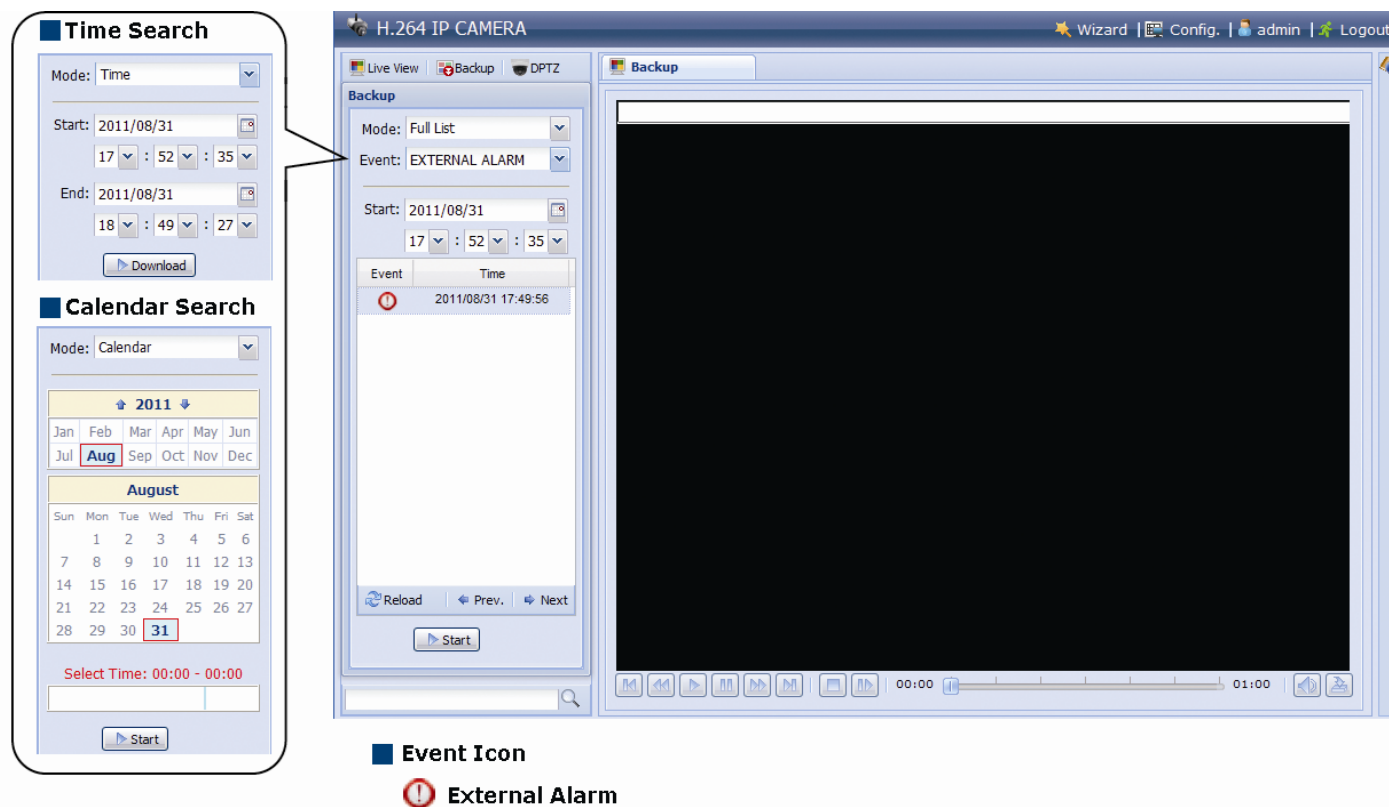

FUNCTION	ICON	DESCRIPTION
Resolution	--	Select the video resolution for the DPTZ function. Only “VGA” and “QVGA” are available.
Take snapshots		Click to take a snapshot of the current view on a new window. Right click on the picture and re-save it to the location you want.
Audio On / Off	 / 	Click to switch the audio-in on / off.
Alarm Out		Click to force your alarm-out device to work. For example, when your alarm device is a buzzer, click this button and your buzzer will start to sound even if there’s no alarm event.
Microphone	 / 	Click to switch the audio-out on / off. <i>Available only when you’re a “Supervisor”.</i>

2.4 Event Record Search & Playback

This camera can only save up to three alarm recordings.

Note: To save more recorded data, it's recommended to use this camera with the compatible NVR.



	Previous / Next Hour	Click to jump to the next / previous time interval in an hour, for example, 11:00 ~ 12:00 or 14:00 ~ 15:00, and start playing the earliest event video clip recorded during this whole hour.
	Fast Forward	Increase the speed for fast forward. Click to get 2X, 4X, 8X & 16X speed forward eventually.
	Fast Rewind	Increase the speed for fast rewind. Click to get 2X, 4X, 8X & 16X speed rewind eventually.
	Play	Click to play the current video clip.
	Pause	Click to pause the video playback.
	Stop	Click to stop the video playback.
	Step	In the pause mode, click to get one frame forward.
	Audio	Click to mute the playback if necessary, and click again to restore.
	Download	Click to download the current video clip to the specified path in your PC. <i>The downloaded video can only be opened by our own video player. Please go to "General" → "Maintenance" to download the video player, or get the player from the CD supplied with the sales package.</i>

3. CAMERA CONFIGURATIONS

Users can further configure this network camera by accessing via Internet Explorer.

3.1 System configuration menu

Click “Config.” to enter the configuration page.

The functions are categorized into six menus: Network, Camera, Record Timer, Storage, Trigger and General.

- For details about “Network”, please refer to “3.2 Network” at page 8.
- For details about “Camera”, please refer to “3.3 Camera” at page 11.
- For details about “Record”, please refer to “3.4 Record” at page 13.
- For details about “Storage”, please refer to “3.5 Storage” at page 13.
- For details about “Trigger”, please refer to “3.6 Trigger” at page 14.
- For details about “General”, please refer to “3.7 General” at page 15.

Main Menu	Sub-Menu	Reference
Network	Network	Configure network settings.
	QoS	Limit the data flow for live streaming.
	DDNS	Enter DDNS information when the network type is PPPOE or DHCP.
	SNTP	Synchronize your camera time with the networked computer systems.
	FTP	Enter the FTP information for event notifications when “FTP” is chosen in “Trigger” → “Trigger”.
	Mail	Enter Email information for event notifications when “Email” is chosen in “Trigger” → “Trigger”.
	Filter	Choose to permit or block the IP address(es) which can access this camera.
	UPnP	<i>*Suitable for Windows-based operating system.</i> Allow this camera to be detected among devices within the same network area for easy and quick usage.
Camera	Bonjour	<i>*Suitable for Apple Mac-based operating system.</i> Allow this camera to be detected among devices within the same network area for easy and quick usage.
	Camera	1. Rename the camera. 2. Change the place where the camera name is shown on the screen.
	Video	Adjust video-related settings in different video format.
	Color	Adjust the color performance.
	Audio	Adjust the audio volume of the microphone and speaker.
Record	Advance	Adjust the camera parameters if necessary.
	Record	Configure the record function.
Storage	Record Timer	Schedule external alarm recording.
	Memory	Check the current storage capacity and clear all recorded data when needed.
Trigger	Trigger	1. Enable / disable motion, alarm and PIR detection. 2. Set the motion detection area. 3. Configure how the camera reacts for any event.
	Push Video	1. Set Push Video rules. 2. Schedule Push Video timer.
General	General	1. Select the language of the web browser. 2. Check the MAC address of the camera. 3. Lock camera access after the specified time. 4. Enable or disable LED status indication.
	Time	Set daylight saving time and the current time.
	Server Log	Check the system event logs.
	Online	Check the current online user(s).
	Account	1. Create a new user account with different access privilege. 2. Modify or delete an existing user account.
Maintenance	Maintenance	1. Check the current firmware version and upgrade your camera. 2. Copy system configurations. 3. Reboot the camera. 4. Download the video player to play the recorded data.

3.2 Network

3.2.1 Network

You can set the network configuration of the network camera depending on your network type.

For details, please refer to “Advanced Network Setup” from www.surveillance-download.com/user/n806.swf.

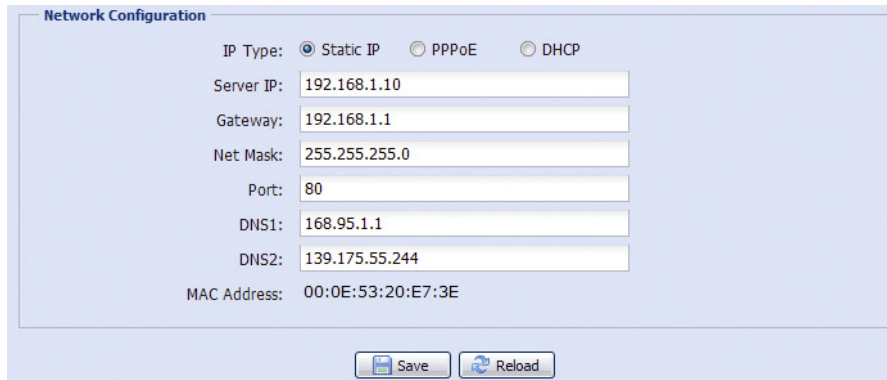

The screenshot shows the 'Network Configuration' window. It features radio buttons for 'Static IP' (selected), 'PPPoE', and 'DHCP'. Below are input fields for 'Server IP' (192.168.1.10), 'Gateway' (192.168.1.1), 'Net Mask' (255.255.255.0), 'Port' (80), 'DNS1' (168.95.1.1), and 'DNS2' (139.175.55.244). The 'MAC Address' is displayed as 00:0E:53:20:E7:3E. At the bottom are 'Save' and 'Reload' buttons.

3.2.2 QoS

QoS, Quality of Service, is the ability to control the data flow for real-time streaming. This function is important if your network bandwidth is insufficient and you have other devices to share the network bandwidth.

Check “QoS Enable”, and set the max. upload rate from 256 to 10240 kbps.

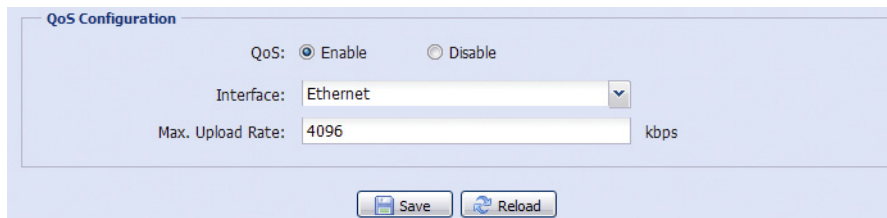

The screenshot shows the 'QoS Configuration' window. It has radio buttons for 'Enable' (selected) and 'Disable'. The 'Interface' is set to 'Ethernet' in a dropdown menu. The 'Max. Upload Rate' is set to 4096 kbps. 'Save' and 'Reload' buttons are at the bottom.

3.2.3 DDNS

Select “On” when the selected network type in “Network” is “PPPOE” or “DHCP”.

For details, please refer to “Advanced Network Setup” from www.surveillance-download.com/user/n806.swf.

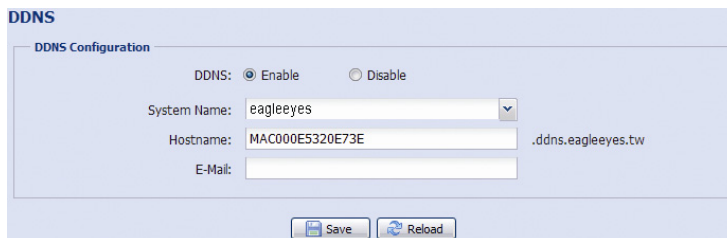

The screenshot shows the 'DDNS Configuration' window. It has radio buttons for 'Enable' (selected) and 'Disable'. The 'System Name' is 'eagleeyes' in a dropdown. The 'Hostname' is 'MAC000E5320E73E' with '.ddns.eagleeyes.tw' next to it. There is an empty 'E-Mail' field. 'Save' and 'Reload' buttons are at the bottom.

3.2.4 SNTP

SNTP (Simple Network Time Protocol) is used to synchronize your camera time with the networked computer systems.

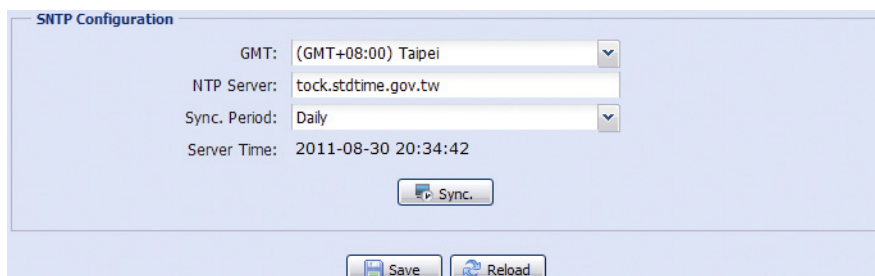

The screenshot shows the 'SNTP Configuration' window. It has a 'GMT' dropdown set to '(GMT+08:00) Taipei'. The 'NTP Server' is 'tock.stdtime.gov.tw'. The 'Sync. Period' is 'Daily' in a dropdown. The 'Server Time' is '2011-08-30 20:34:42'. There is a 'Sync.' button and 'Save' and 'Reload' buttons at the bottom.

Function	Description
GMT	Once users choose the time zone, the network camera will adjust the local area time of the system automatically.
NTP Server	Simply use the default SNTP server (For example, tock.stdtime.gov.tw) or change to another server with which users are familiar.
Sync. Period	Select “Daily” to synchronize the camera time with the network time every day or “None” to turn off this function.
Sync	Click and the network camera will synchronize the time with the network time.

3.2.5 FTP

Enter the detailed FTP information and click “Save” to confirm. The information you set here will be applied when “FTP” is selected in “Trigger” → “Trigger”.

3.2.6 MAIL

Enter the detailed e-mail information and click “Save” to confirm. The information you set here will be applied when “Email” is selected in “Trigger” → “Trigger”.

Function	Description
SMTP Server	Enter the SMTP server address provided from your e-mail system supplier.
Port	Enter the port number provided from your e-mail system supplier. If this column is left blank, the e-mail server will use port 25 to send e-mails.
Mail From	Enter the name of the sender.
SSL Encryption	Select “Yes” if your e-mail server is using SSL encryption to protect your e-mail content from unauthorized access.
Verify Password	Some mail servers are required to verify the password. Please enter the “user name” and “password”.
E-Mail Address List	Add the e-mail address(s) of the assigned recipient(s).
Test	When all information is entered, click “Test Mail” to try if the receipt.

3.2.7 Filter

Choose to permit or block the IP address(es) which can access this camera, and click “Save” to confirm.

Function	Description
Filter Configuration	
Error Count	Set the maximum count for login failure. When the maximum count is reached, the IP address trying to access the network camera will be locked.
Error Lock Time	Set the lock time in minutes when the maximum count of error login for an IP address is reached.
Echo Request	Select "Non-Block" to allow other users to use the ping command to detect the IP address of your network camera, or "Block" to deny the ping command request.
IP/MAC Filter Configuration	
IP/MAC Filter	Choose to enable or disable the filter function.
IP/MAC Filter Policy	If "Enable" is selected, choose whether you want to permit (Allow) or block (Deny) the IP address list below.
IP/MAC Filter Rules	
Rule	<ul style="list-style-type: none"> To add an item to the IP address list, key in the IP address in "Rule", and click "Add". To remove an existing item in the IP address list, click the item you want to remove, and click "Delete".

3.2.8 UPnP / Bonjour

"UPnP" stands for "Universal Plug and Play", which allows devices to connect seamlessly in the home and corporate environments and simplify installation of computer components, and is only suitable for Microsoft Windows-based operating system.

"Bonjour" functions the same as "UPnP", but it's only suitable for Apple Mac-based operating system.

➤ UPnP

➤ Bonjour

Check "Enable" to allow the network camera to be detected among devices within the same network area, and set the identification name of the camera in "Friendly name".

When this function is activated, the other PC within the same domain as this camera will be able to search this camera in:

- "Network Neighbor" with the identification name set in "Friendly name" for Windows-based PC, or
- "Finder" (finder) or "Bookmark" with the identification name set in "Device Name" for Mac-based PC.

Double-click it to quickly open the web browser for camera access.

Port Mapping (Available only in UPnP)

This function can eliminate the need to additionally access the router for port forwarding.

For details, please refer to "Advanced Network Setup" from www.surveillance-download.com/user/n806.swf.

Note: Before using this function, make sure your router supports UPnP, and this function is enabled. If not, please access your router additionally for port forwarding.

When "Port Mapping" is set to "Enable", the system will automatically assign an IP address or port number for you if no IP address or port number is entered.

Port Mapping Configuration

Port Mapping: Enable Disable

Your IP-Camera is accessible from the other side of the router using the following URL:
 http://60.248.97.4:80 or https://60.248.97.4:59207.

Router IP: (LAN IP Address)

HTTP Port:

HTTPS Port:

*If set to blank or 0, a port number will be set automatically upon enable.

Note: When the configurations are saved successfully, you'll see a message indicating the IP address and port number assigned to this network camera.

3.3 Camera

3.3.1 Camera

Rename the camera, and change the place where the camera name is shown on the screen, UP-LEFT / UP-RIGHT / DOWN-LEFT / DOWN-RIGHT.

Camera

Camera Configuration

Title:

Position:

3.3.2 Video

Adjust video-related settings in different video format.

- "Quality" is related to image clearness.
- "FPS" is related to the fluency of the video. The more the FPS, the more fluent the video.
- "Max Bit Rate" is the maximum limitation of data transmission in the selected image format and resolution.

Note: QQVGA is for mobile surveillance only.

Video Configuration

Configuration

Power Line Frequency: Hz

H264

Resolution	Quality	FPS	Max Bit Rate
SXGA / HD720P	HIGH	30	5000
VGA	HIGH	30	3000
QVGA	HIGH	30	3000
QQVGA	HIGH	30	3000

MPEG4

Resolution	Quality	FPS	Max Bit Rate
SXGA / HD720P	HIGH	20	5000
VGA	HIGH	30	3000
QVGA	HIGH	30	3000
QQVGA	HIGH	30	3000

JPEG

Resolution	Quality	FPS
SXGA / HD720P	HIGH	30
VGA	HIGH	30
QVGA	HIGH	30
QQVGA	HIGH	30

3.3.3 Color

Adjust the color performance from Brightness, Contrast, Hue and Saturation. Click and drag the slider to preview the color change on the right side of this page and adjust the image color.

To restore the default values, click “Back to Default”.

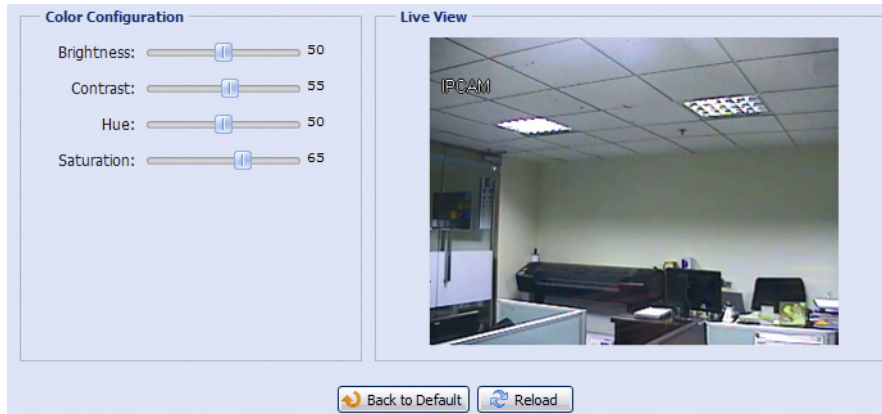

3.3.4 Audio

Drag the slider to adjust the volume of the microphone and speaker.

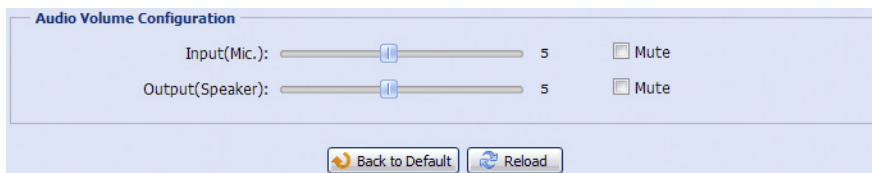

3.3.5 Advanced

Adjust the camera parameters if necessary.

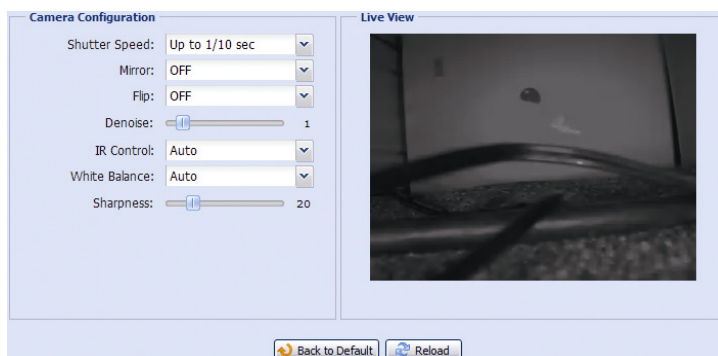

Item	Description
Shutter Speed	Set the shutter speed based on your need. The options are: Up to 1/10 sec, Up to 1/30, Up to 1/15, Up to 1/6, Up to 1 and Up to 2.
Mirror	Select “ON” to rotate the images horizontally based on your installation situation when necessary.
Flip	Select “ON” to rotate the image 180° when necessary.
De-noise	Click and drag the slider to adjust the level from 0 ~ 10 to decrease the noise shown in the dark environment.
IR Control	Select “Auto” to automatically enable IR LEDs at night or in the dark environment, “On” to always enable IR LEDs, or “OFF” to disable this function.
White Balance	Process the current image to retain color balance over a color temperature range. The options are: Auto, Incandescent Light, Cool Light, sun Light, Cloudy & Sun Shade.
Sharpness	Sharpness enhances the clarity of image detail by adjusting the aperture and sharpening the edges in the pictures. Hold and drag the slider to adjust the level of sharpness from 0 ~ 100. The higher the value, the sharper the image.

3.4 Record

3.4.1 Record

In “Record Configuration”, you can:

- Enable or disable the alarm record function. When “Enable” is set to “No”, the alarm record function is disabled even if you enable it in other configuration pages.
- Select if the data should be overwritten when the memory storage is full.
- Enable or disable the audio record function.
- Select the video resolution for event recording.

Note: The higher resolution you choose, the more accuracy and higher image quality the recording will be, but the faster the memory storage is consumed and become full.

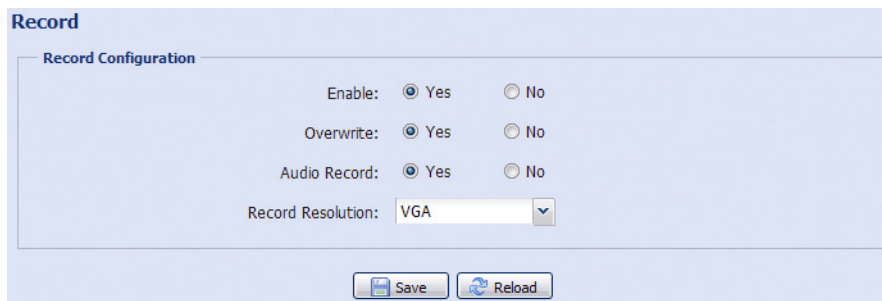

3.4.2 Record Timer

To schedule alarm recording, enable it, and select the day and time for recording.

Note: The timer must be enabled for the record function to work properly.

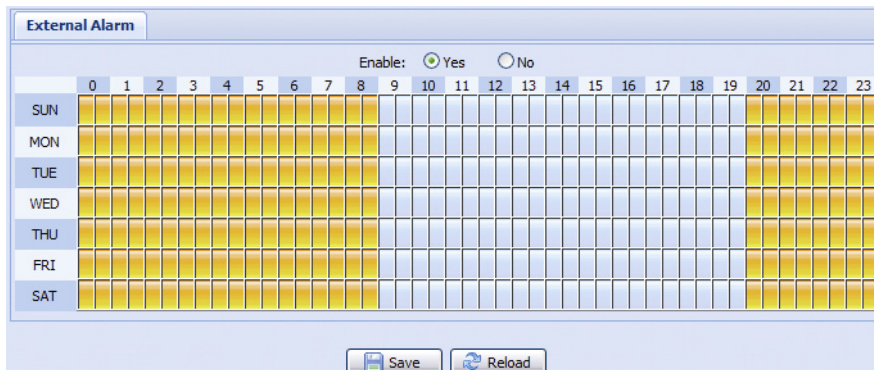

3.5 Storage

3.5.1 Memory

In “Memory”, you can check the remaining capacity for recording, or clear all recorded data saved if needed.

Note: The recorded data will be removed also when you reset or reboot this camera.

Note: To save more recorded data, it's recommended to use this camera with the compatible NVR.

Note: To know the total recording time per recording resolution, please refer to “APPENDIX 4 RECORDING TIME TABLE” at page 24.

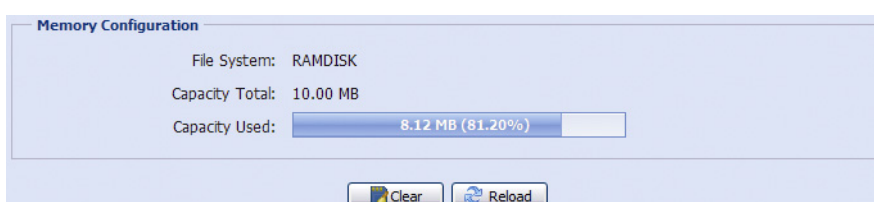

3.6 Trigger

3.6.1 Trigger

You can configure how this camera reacts when there's an alarm or motion event.

◆ Detect

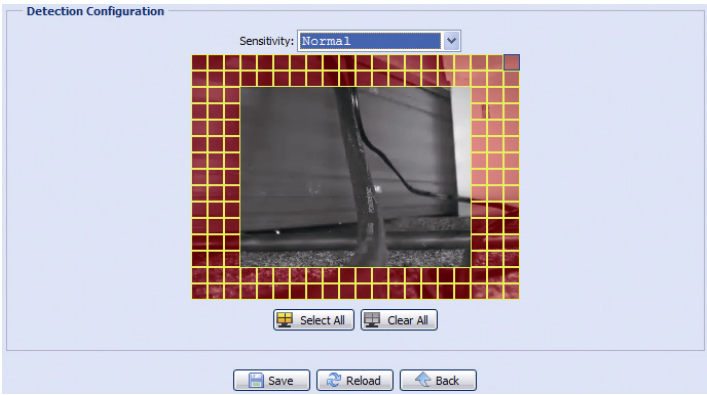
Item	Description
External Alarm	Enable or disable detection from external alarm-in device, and click the title "External Alarm" (in blue) to set "N.O." or "N.C." depending on the configuration of your alarm-in device.
Motion	<p>Enable or disable motion detection.</p> <p><i>Motion detection is not supported when the stream format is Motion JPEG.</i></p> <p>When "Enable" is selected, click "Detection" to enter the motion detection area setting page as follows:</p>  <p>Sensitivity: Set the detection sensitivity from the drop-down list: High, Normal or Low.</p> <p>Area Setting: Set the motion detection area by selecting the area grids with your mouse. Pink grids represent the area that is not being detected while the transparent grids are the area under detection. You can set multiple areas under detection. Click "Clear All" to set the whole area undetected. Click "Select All" to set the whole area under detection.</p>
Duration	Set the duration time for trigger recording (5 / 10 / 20 / 40 seconds).

◆ Action

Here defines how the camera delivers alerts to you for any event.

Item	Description
E-Mail	Select the event type you want to receive E-mail notifications when it occurs. Then, click the title "E-Mail" (in blue) to configure the media type (H264 / JPEG / MPEG4), file format (AVC / AVI), and record time (1 ~ 5 seconds) for the event video clip. The camera will send the captured video clip to the E-mail address(s) you assigned in "Network" → "Mail" once the selected event type occurs.
FTP	Select the event type you want to receive FTP notifications when it occurs. Then, click the title "FTP" (in blue) to configure the media type (H264 / JPEG / MPEG4), file format (AVC / AVI), and record time (1 ~ 5 seconds) for the event video clip. The camera will upload the captured video clip to the FTP site you assigned in "Network" → "FTP" once the selected event type occurs.
Alarm Out	Select the event type you want to trigger the alarm-out device to work when it occurs. Then, click the title "Alarm Out" (in blue) to configure the trigger rule (LOW / HIGH).
Record	Select the event type you want to enable event recording when it occurs.
Audio Alert	Select the event type you want to enable audio alert when it occurs.

3.6.2 Push Video

"Push Video" is an active notification system, different from traditional FTP and Email notification methods.

Note: For Push Video to work properly, make sure the record function is on in "Record" → "Record", and the record timer for the external alarm is on in "Record" → "Record Timer".

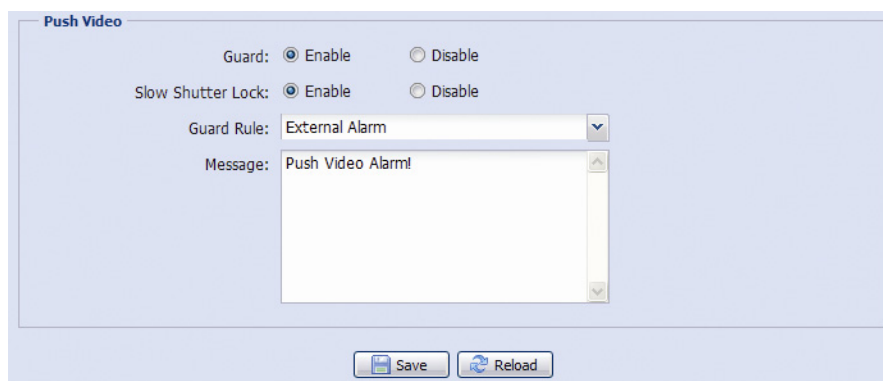

Item	Description
Guard	Select to enable or disable Push Video. This function can also be enabled from your iPhone or Android mobile devices. <i>When this function is enabled, the image resolution is fixed to "VGA".</i>
Slow Shutter Lock	Select to fix the slow shutter level to level 2 (Enable) or remain the current slow shutter level (Disable) when Push Video is enabled. When this function is enabled, it could ensure Push Video recording to get clear images when the environment is dark. This function is set to "Enable" by default.
Guard Rule	Select the rule to enable Push Video from "External Alarm".
Message	Define the context when you receive the Push Video message on your iPhone or Android mobile device. Up to 28 characters are allowed.

To configure Push video to enable in the specified time, select "Yes" to enable the timer function, and select the time you want to enable.

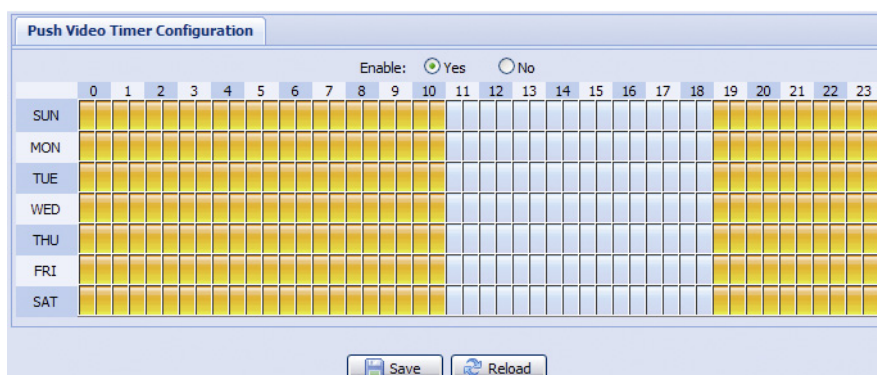

3.7 General

3.7.1 General

To change the language of UI interface, select from the drop-down list in “Language”.

To allow the status LED indicators to show the status as indicated in “1.6 Status Indicator” at page 2, select “Enable” in “Status LED Mode”; to hide the status, select “OFF”; to only show the error status, select “Temporary Disable”.

Note: The status LED mode will be restored to “Enable” after camera reboot when “Temporary OFF” is selected.

To lock camera access when it’s not used after the specified time, select “5 MIN”, “15 MIN” or “30 MIN” from the drop-down list of “Auto Lock Time”, or select “NEVER” to disable this function.

Note: When the camera access is locked after the specified time, to resume camera access, please enter the password.

General

General Configuration

Language: English

Status LED Mode: Enable

Auto Lock Time: 15 MIN

MAC Address: 00:0E:53:E6:29:B3

Save Reload

3.7.2 Time

Set daylight saving time and the current time, and click “Save” to confirm.

Time

Time Configuration

OSD: Enable Disable

Date: 2011/08/30

Time: 21 : 16 : 41

Save Reload

Daylight Saving Time

Daylight Saving Time Configuration

Daylight Saving Time: Enable Disable

Start Time: August First Week Monday 6 : 0 (HH:MM)

End Time: October Fifth Week Monday 10 : 0 (HH:MM)

Adjust Time: 1 : 0 (HH:MM)

Save Reload

Function	Description
■ Time Configuration	
Date	Set the current date.
Time	Set the current time.
■ Daylight Saving Time Configuration	
Daylight Saving Time	Specify whether to use daylight saving time (Enable / Disable).
	If this function is enabled, set the time period (Start Time / End Time), and adjust the daylight saving time in hours (Adjust Time).

3.7.3 Server Log

To quickly search the system logs you want by event type, click “Prev. Page” or “Next Page” to find the logs you want, or check the event type(s) and click “Reload” to start searching.

To clear all system event logs, click “Clear All”.

Server Log List

No.	Event	Time	Result
1	Remote Login	2011/08/30 20:54:41	admin
2	Remote Login	2011/08/30 20:29:58	admin
3	Remote Login	2011/08/30 18:22:08	admin
4	SNTP Update	2011/08/30 18:20:06	Failed
5	Remote Login	2011/08/30 18:20:03	admin
6	Power On	2011/08/30 18:19:24	ON
7	Power On	2011/08/30 18:18:46	OFF
8	Remote Login	2011/08/30 18:11:21	admin
9	Remote Login	2011/08/30 18:11:18	admin
10	Remote Login	2011/08/30 18:07:10	admin
11	Remote Login	2011/08/30 18:03:19	admin
12	Remote Login	2011/08/30 18:02:15	admin
13	Remote Login	2011/08/30 18:02:07	admin
14	Remote Login	2011/08/30 18:01:51	admin
15	Remote Login	2011/08/30 17:57:01	admin
16	Remote Login	2011/08/30 17:56:55	admin
17	Remote Login	2011/08/30 17:56:53	admin
18	Remote Login	2011/08/30 17:54:44	admin
19	SNTP Update	2011/08/30 17:50:48	Failed
20	Power On	2011/08/30 17:50:07	ON

Prev. Page Next Page Reload Clean All

3.7.4 Online

You can check the current online user(s) with respective online information. To refresh the list, click “Reload”.

- To allow anonymous login, select “Enable” in “Anonymous Viewer Login”.
- To disable image code verification at login, select “No” in “Login with CAPTCHA Image”.

Online Configuration

Anonymous Viewer Login: Enable Disable

Login with CAPTCHA Image: Yes No

Max Online User:

Username	IP Address	User Level	Media Type
admin	211.75.84.96	SUPERVISOR	H264
admin	60.248.97.4	SUPERVISOR	H264

Reload

Save Reload

3.7.5 Account

You can create a new account with different user access privilege, or delete or modify an existing account setting.

How to create a new account

Step1: Click “New”, and fill in the following columns.

Account

Username	User Level	Life Time
admin	SUPERVISOR	INFINITE
power	POWER USER	1 HOUR
normal	NORMAL	1 HOUR
guest	GUEST	1 HOUR

New Account Info

Username:

Password:

Confirm Password:

User Level:

Life Time:

Save Close

Add Edit Delete

Column	Description
User Name	Set a user name that will be used for camera access. The user name allows up to 16 alphanumeric characters.
Password	Set the password that will be used for remote login. The password allows up to 16 alphanumeric characters.
Confirm Password	Enter the password again to confirm.
User Level	Set the security level of an account to give the permission to control different functions. There are four user levels: SUPERVISOR, POWER USER, NORMAL USER and GUEST.
Life Time	Select how long this account is allowed to stay online (1 MIN / 5 MIN / 10 MIN / 1 HOUR / 1 DAY / INFINITE)

Step2: Then, click “Save” to save your setting and create a new account.

How to modify or delete an existing account

Step1: Select the account you want to modify or delete.

Step2: To modify the account, click “Edit” to change the settings, and click “Save”.

To remove the account, click “Delete”.

Note: It’s not allowed to remove an account when there’s only one account in the account list.

3.7.6 Maintenance

Firmware Upgrade

This function is used when users need to upgrade the camera for function scalability.

Note: Before using this function, make sure you have the correct upgrade files provided by your installer or distributor.

Note: The event videos saved in the camera will be removed after firmware upgrade. Make sure you’ve copied important events to your PC before firmware upgrade.

Step1: Select “” to browse to where you save the upgrade files, and select them one by one until all files are selected (up to four files).

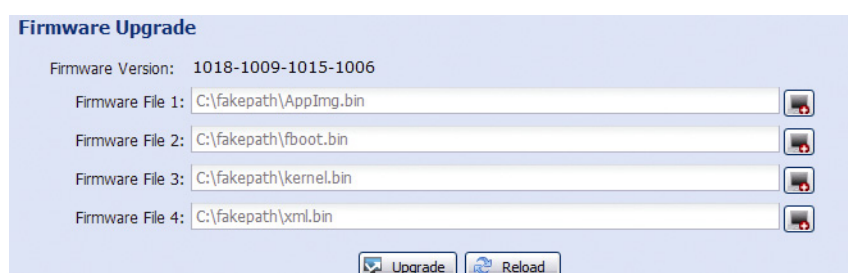

Step2: Select “Upgrade” to start system upgrading.

Note: You’ll be prompted to keep current configurations. It’s recommended to keep them, or all configurations will be restored to default values after upgrade.

Note: It takes a few minutes to finish the upgrade process. Do not disconnect the power during firmware upgrade, or the upgrade may be failed. The camera will reboot after the upgrade.

System Configuration Backup

This function is used to copy your system configuration to a “System.bin” file.

You may import the same system configuration to another camera, or restore your system configuration when the camera is reset to default values.

Select “System.bin” in “Firmware Upgrade”, and select “Upgrade” to import the system configuration.

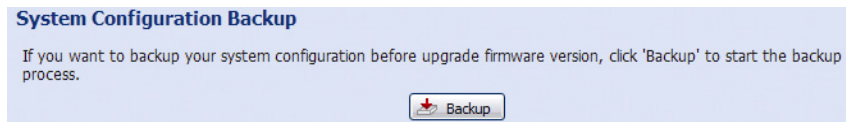

System Reboot

Select “Reboot” to restart your camera if needed.

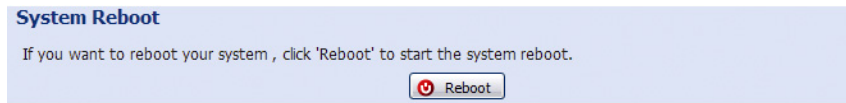

Player Download

To see the event video clips downloaded to your PC, you need to first install our own video player in your PC. Select “Free Download” to download the video player, and double click the file to install it.

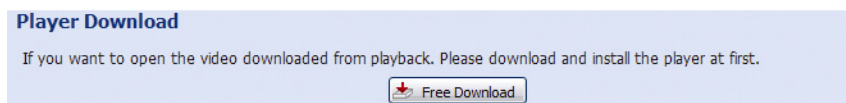

APPENDIX 1 PRODUCT SPECIFICATIONS

■ Network	
Network Compression	H.264 / MPEG4 / MJPEG
Multiple Video Streaming (Encode Modes, IPS, Resolution)	3 (H.264, MJPEG, MPEG4)
LAN Port	YES
LAN Speed	10/100 Based-T Ethernet
Supported Protocols	DDNS, PPPoE, DHCP, NTP, SNTP, TCP/IP, ICMP, SMTP, FTP, HTTP, RTP, RTSP, RTCP, IPv4, Bonjour, UPnP, DNS, UDP, IGMP, QoS
Frame Rate	30 FPS
Number of Online Users	10
Security	<ol style="list-style-type: none"> 1. Multiple user access levels with password 2. IP address filtering 3. Digest authentication
Remote Access	<ol style="list-style-type: none"> 1. Internet Explorer on Windows operating system 2. EagleEyes on iPhone, iPad and Android mobile devices
ONVIF Compatible	YES
■ Camera	
Image Sensor	1/4" SONY H.R. image sensor
Video Resolution	SXGA / HD720P / VGA / QVGA
Min Illumination	0.1 Lux / F1.5, 0 Lux (IR LED ON)
S/N Ratio	More than 48dB (AGC off)
Lens	f3.8mm / F1.5
Viewing Angle	53.7° (Horizontal) / 34.1° (Vertical) / 62.7° (Diagonal)
IR LED	12 units
IR Effective Range	Up to 10 meters
IR Shifter	YES
LED Indication	YES
White Balance	ATW
AGC	Auto
IRIS Mode	AES
External Alarm I/O	YES
Microphone	YES
Speaker	YES
Power Source (±10%)	5V / 1A
Operating Temperature	0°C~40°C
■ Others	
Mobile Surveillance	iPad, iPhone & Android mobile device
RTC (real-time clock)	YES
Motion Detection	YES
Digital Pan / Tilt / Zoom	YES
Event Notification	FTP / Email / Push Video
Minimum Web Browsing Requirements	<ul style="list-style-type: none"> • Pentium 4 CPU 1.3 GHz or higher, or equivalent AMD • 256 MB RAM • AGP graphics card, Direct Draw, 32MB RAM • Windows 7, Vista & XP, DirectX 9.0 or later • Internet Explorer 7.x or later

* The specifications are subject to change without notice.

** Dimensional tolerance: ± 5mm

*** QQVGA is for mobile surveillance only

APPENDIX 2 BIT RATE TABLE FOR REFERENCE

The data below is for reference only.

The bit rates listed here may vary depending on the resolution, image quality & frame rate you choose, the complexity of your monitoring area, and how often the moving objects show in your monitoring area.

Testing Environment

- Place: Office Entrance
- Network translation: H.264
- Camera type: Megapixel camera

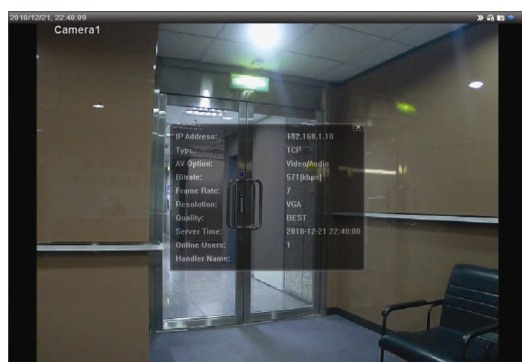

Static: No one coming in and out



Dynamic: One or two people coming in and out

Resolution	Quality	Frame Rate	(Dynamic) kbps	(Static) kbps	
SXGA	Best	FULL	3253	3216	
	High		2375	2160	
	Normal		1571	1266	
	Basic		1465	873	
VGA	Best		2010	1261	
	High		1042	1034	
	Normal		685	572	
	Basic		457	350	
QVGA	Best		646	366	
	High		482	350	
	Normal		302	286	
	Basic		168	161	
SXGA	Best		1/4	1163	1076
	High			989	715
	Normal			855	534
	Basic			719	443
VGA	Best	789		571	
	High	451		447	
	Normal	349		237	
	Basic	217		165	
QVGA	Best	269		147	
	High	182		131	
	Normal	164		113	
	Basic	97		71	

Resolution	Quality	Frame Rate	(Dynamic) kbps	(Static) kbps
SXGA	Best	1/15	581	374
	High		405	342
	Normal		487	248
	Basic		337	141
VGA	Best		358	79
	High		201	63
	Normal		180	28
	Basic		92	15
QVGA	Best		111	84
	High		99	68
	Normal		97	54
	Basic		58	42

APPENDIX 3 Q&A

For more details about EagleEyes Q&A, please visit our official website: www.eagleeyesctv.com/supp_QnA.aspx.

Question	Answer
<p>I can connect to this camera in my house or office where it's installed with wireless network.</p> <p>But when I leave my house or office, I can't connect to it from my mobile phone (with 3G network), or other PC (connected to Internet). Why?</p>	<p>You didn't configure this camera to Internet, but only in LAN.</p> <p>Please follow the steps in the advanced network setup guide downloadable from www.surveillance-download.com/user/m317a.swf to complete network configurations, or it's recommended for you to check with your local installer or reseller for this service because it's usually hard for a person who doesn't have network knowledge to set network configurations.</p>
<p>My live images are not fluent. Why?</p>	<p>Image fluency could be affected by the local network upload bandwidth, router efficiency, client network download bandwidth, complexity of live view, and more.</p> <p>(Recommended) To have the best image fluency, select QVGA; to have the best image quality, select "HD1080P" or "SXVGA" based on the model you have; to have normal image fluency and quality, select "VGA".</p>
<p>My image is vague. Why?</p>	<p>The camera might lose its focus. Please rotate the lens to adjust.</p>
<p>The live video keeps flickering. Why?</p>	<p>Please try adjusting the power line frequency to "60 Hz" or "50 Hz" for the camera.</p> <p>For iPhone users, access the camera, and select  on the top right corner to enter IPCAM Configuration page. Then, go to "Advance Setup" → "Camera" to change setting.</p> <p>For access from Internet Explorer, log into the camera, and select "Config." → "Camera" → "Video".</p>

APPENDIX 4 RECORDING TIME TABLE

Below shows the estimated total recording time for each recording resolution.

The recording time per resolution is the average value collected from the both alarm trigger conditions indicated in “Testing Environment”, and is for reference only.

The time may vary depending on the resolution, image quality & frame rate you choose, the complexity of your monitoring area, and how often the moving objects show in your monitoring area.

Testing Environment

- Place: Office
- Monitoring area: 1.5 meters away from the camera
- Alarm trigger conditions:
 - (1) One person walks by the monitoring area and leaves immediately.
 - (2) Two persons walk by the monitoring area. One goes away immediately, and the other one stays a while and goes away.

Recording Resolution	SXGA	VGA	QVGA
Recording time (second)	25	115	211