

# Two-wire Video Intercom System

**V-TCK**

Effective Solution to Security Needs

---

# Why '2' Easy?

## Characters of 2-easy system

- ✓ **All in One**  
Power, audio, and video are transmitted by a 2-wire cable

- ✓ **Non Polarity**  
Never afraid of electric shock

- ✓ **Functional Module on bus wiring**  
Relay actuator, Camera interface, Memory and call divert module

- ✓ **Central power supply**  
No ugly pigtail with extra local power supply

## Max. 256 users

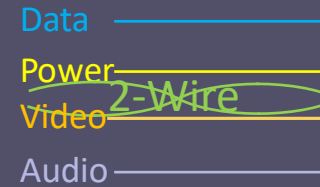

# What's New



## DX Door stations with Internet connectivity

Video memory \_ IP camera connection \_ Call divert \_ 4G module  
XD-Device APP \_ Configuration & Management tool



## DX new Wi-Fi monitors

HD Screen \_ Video memory \_ Camera surveillance \_ Call divert



## Others

DX450 5" Wi-Fi Monitor \_ Glass panel  
DJ9A hand free phone \_ PMMA

# System Door Stations

Metal case \_1~32 button call \_ Keypad \_ Modularized

## Villa door station



Single call button\_ Keypad & Proximity & Touch key access



1~4 call button panel customization \_ Voice prompt

## Apartment door station

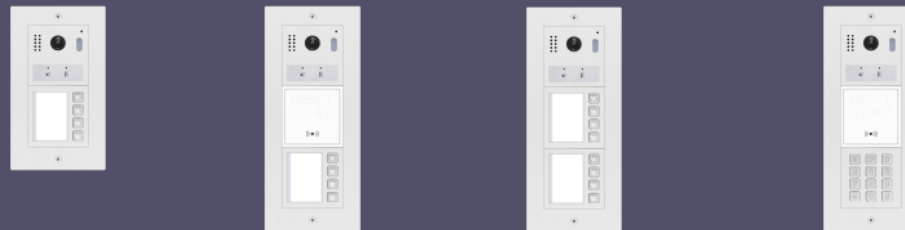

Functional module combination

 Only with surface mounting version

# System Indoor Monitors

4.3" \_ 7" \_ Touch screen \_ Memory record \_ Call divert

Basic Monitor  
4.3" & 7"



OSD \_ icon menu \_ Handset add on\*

Wi-Fi Monitor  
5" & 7"



Wi-Fi connectivity \_ Call divert \_ HD TFT \_ video memory \_ IPC connection \_ PIP \_ Quad

\* For certain models

# System Accessories

Simple & Intelligent \_ Isolation protection \_ Bus connection



Power combo.  
1.5A

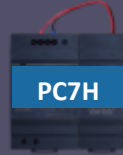

Power combo.  
2.5A



Bus amplifier

Used in case of cable/power problem  
System capacity extender(router function)



Branch Distributor  
with 2 channels

Both can be used as multi door stations switcher

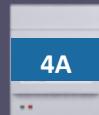

Branch Distributor with 4  
channels

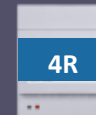

Riser Distributor  
with 4 outputs

Used in case of riser cabling  
Used for multi DX Wi-Fi  
monitors



\*Mini Relay Actuator

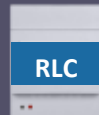

Relay Actuator with 12V  
outputs

Both can be used as the 2<sup>nd</sup> lock controller or stair light controller

\*Full name: 2S---DBC2S, 4A---DBC4A1, 4R---DBC4R, RLC\*—Mini-RLC

# System Capacity

Capacity in villa and apartment system

## Basic Villa

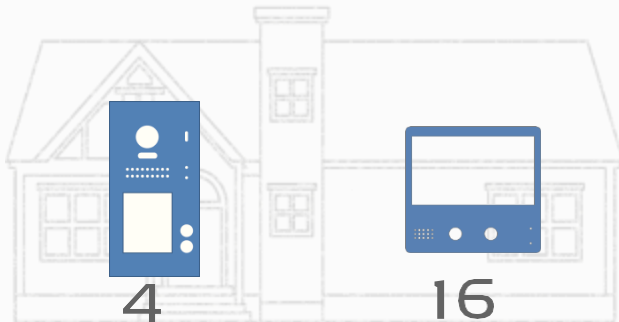

## Low & Middle-rise Building

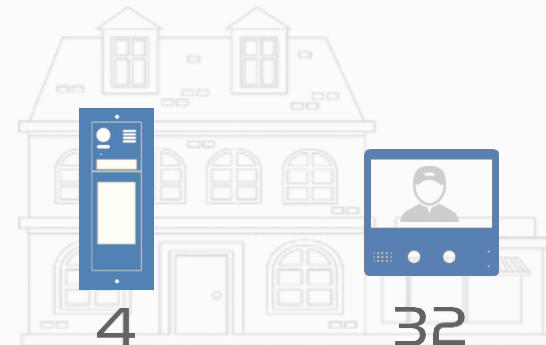

Can be extended 3 monitors in one apartment  
DX821 only supports one door station as an exception

**Max.4 outdoor stations, 32 Indoor monitors in apartment system**

**Have ability to be extended to 256 monitors by BDU router function**

# Typical Wiring In-out Topology

Hand-in-hand Wiring, without distributor

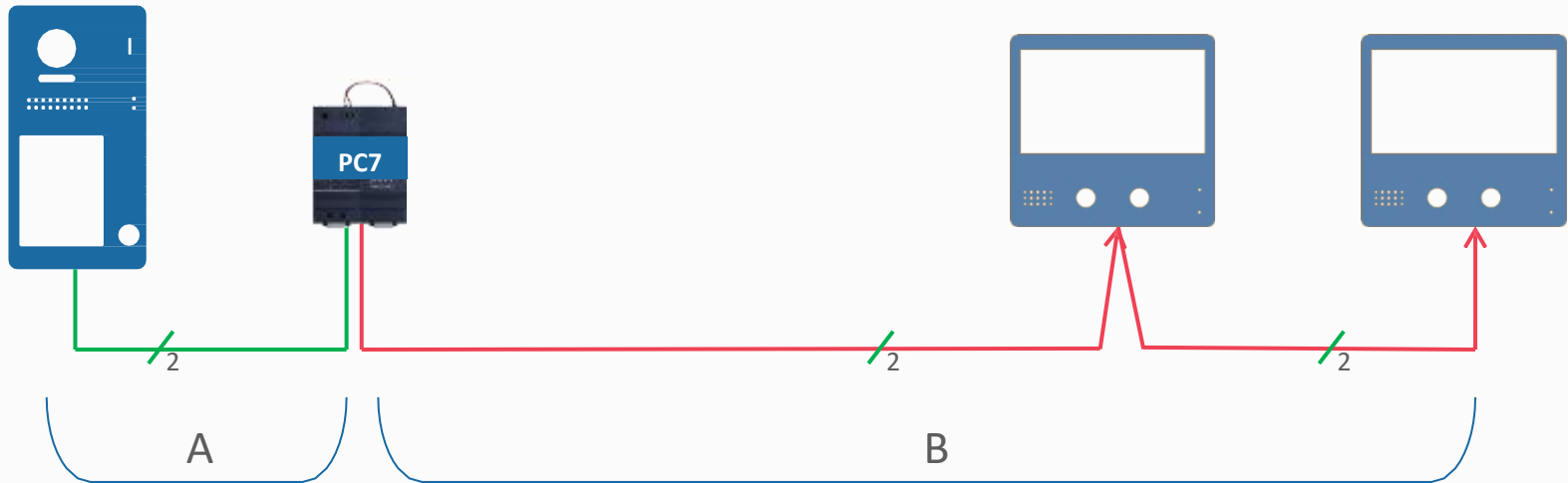

Cable	A	B
Twisted 2x0.75mm	60	100
Twisted 2x1.00mm	80	120
Cat5(Combine)	40	80

\*Distance based on monitor quantity less than 2pcs



# Typical Wiring Star Topology

Star Wiring via DBC2S or DBC4A or DBC4R Distributor

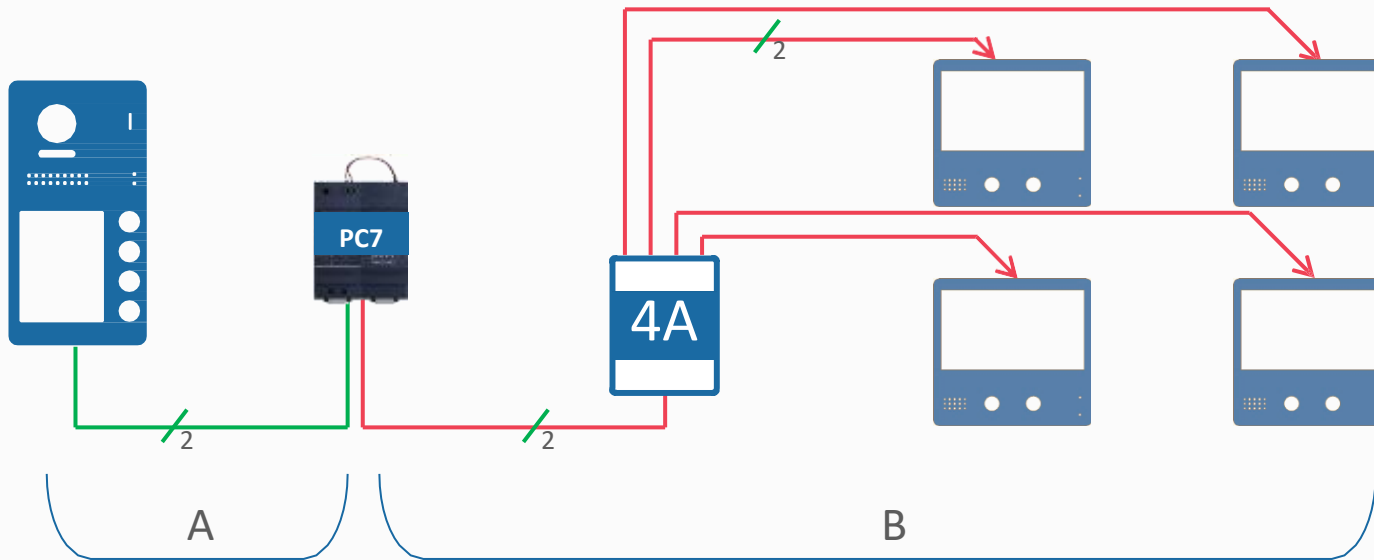

DBC4R distributor should be used if  
Wi-Fi monitor is connected in

Cable	A	B
Twisted 2x0.75mm	60	40
Twisted 2x1.00mm	80	60
Cat5(Combine)	-	-

\*monitor quantity less than 16pcs

# Typical Apartment Wiring

Monitors connection via DBC4 Branch distributor

Max.32 apartments(non Wi-Fi monitor)

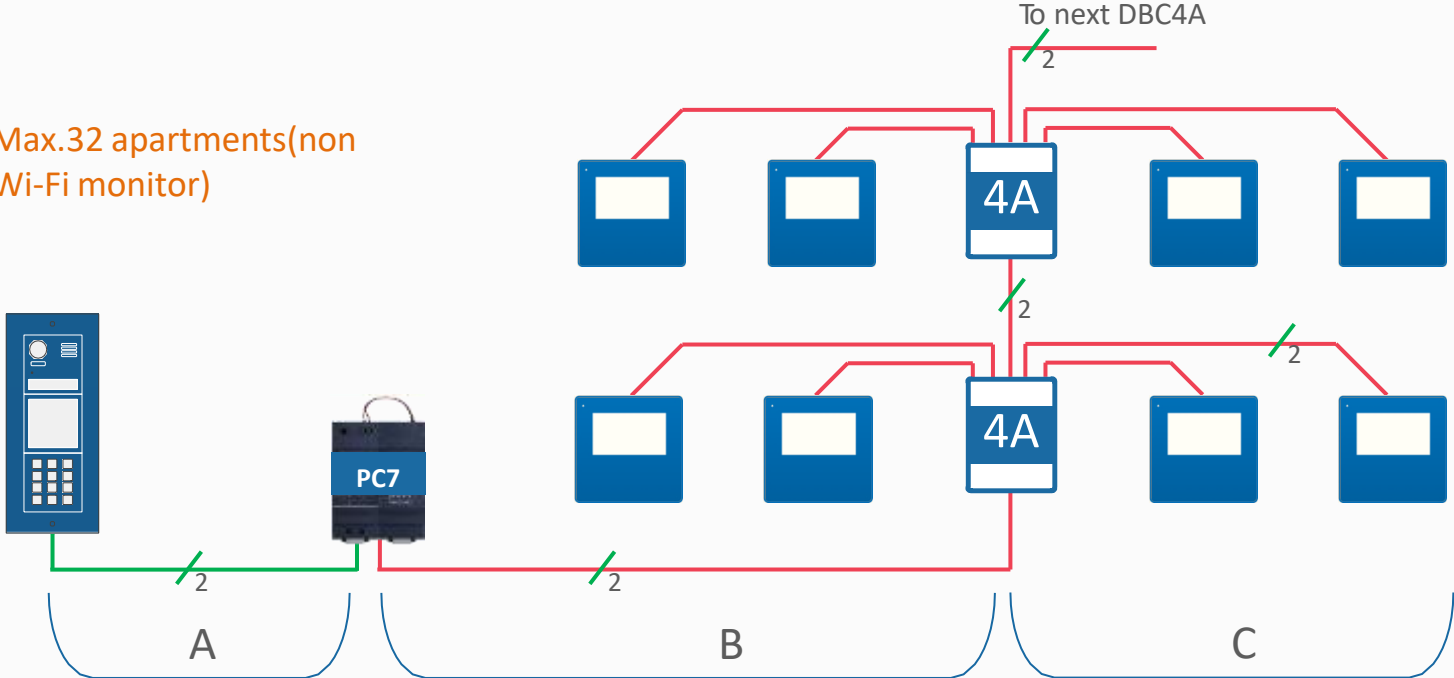

➔ Wi-Fi monitors capacity under one Power supply

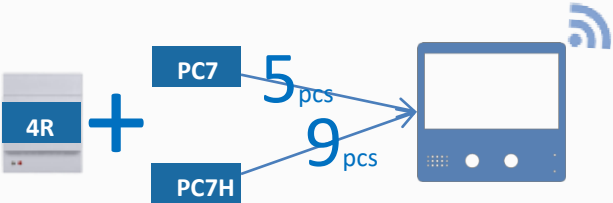

Cable	A	B	C
Twisted 2x0.75mm	60	60	30
Twisted 2x1.00mm	80	80	40
Cat5(Combine)	50	50	20

\*monitor maximum 32pcs

# Typical Wiring- High rise building

Capacity extension via BDU Router

Max.8 BDU(extensions)  
 Max.8\*32=256 apartments

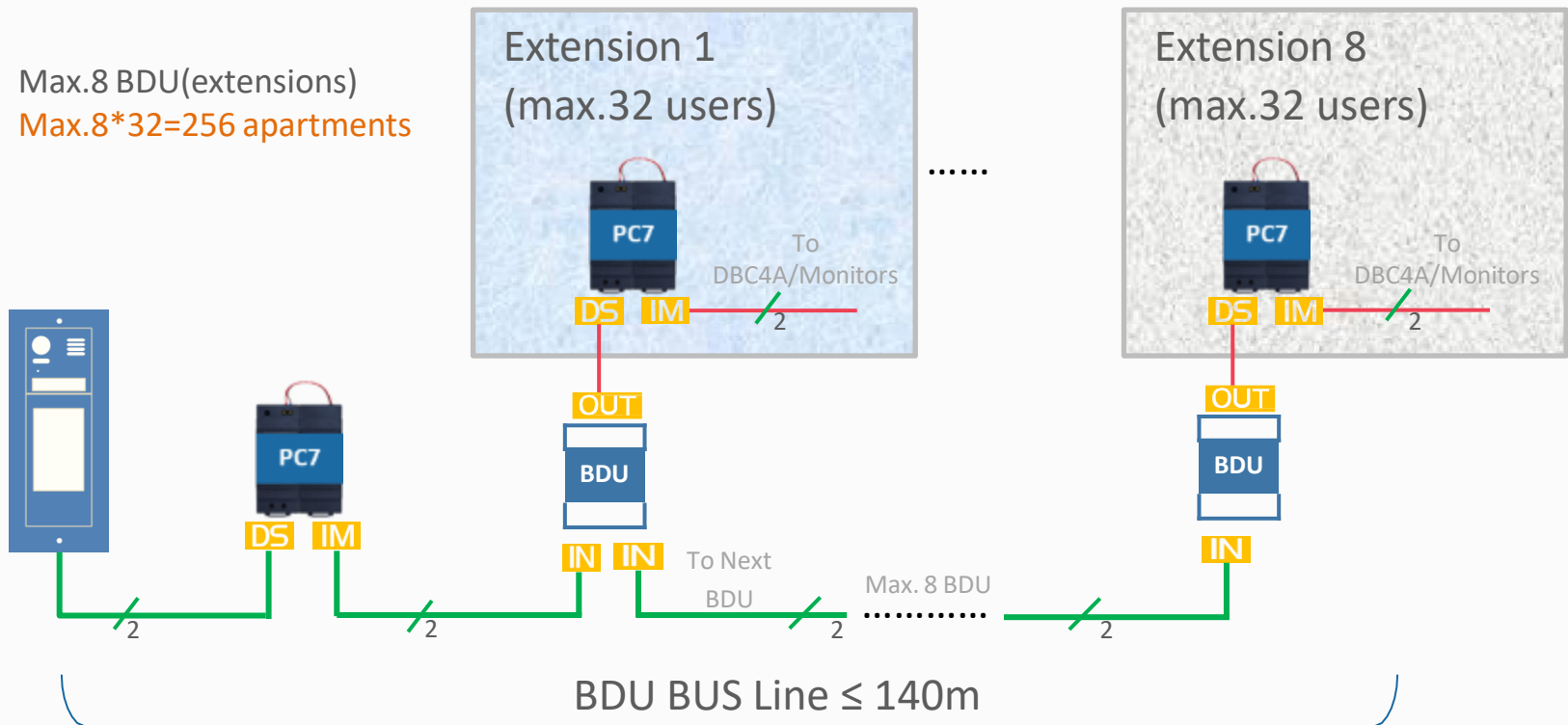

# Typical Wiring Riser-out topology

Riser Wiring via DBC4R Riser Distributor

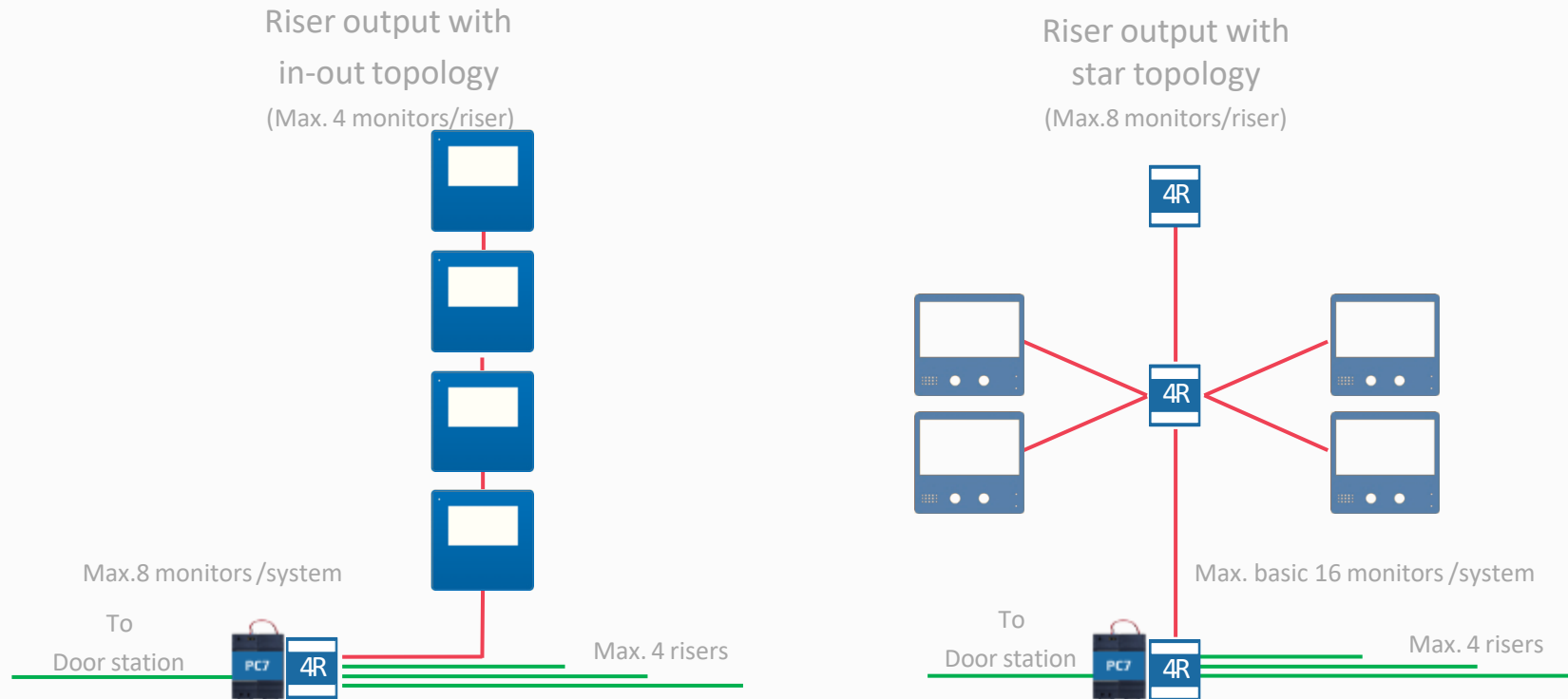

\* Above capacity data is based on non-Wi-Fi monitor

# DX series Door Stations

Integrated \_ Video recording \_ IPC connectivity \_ Call diverter

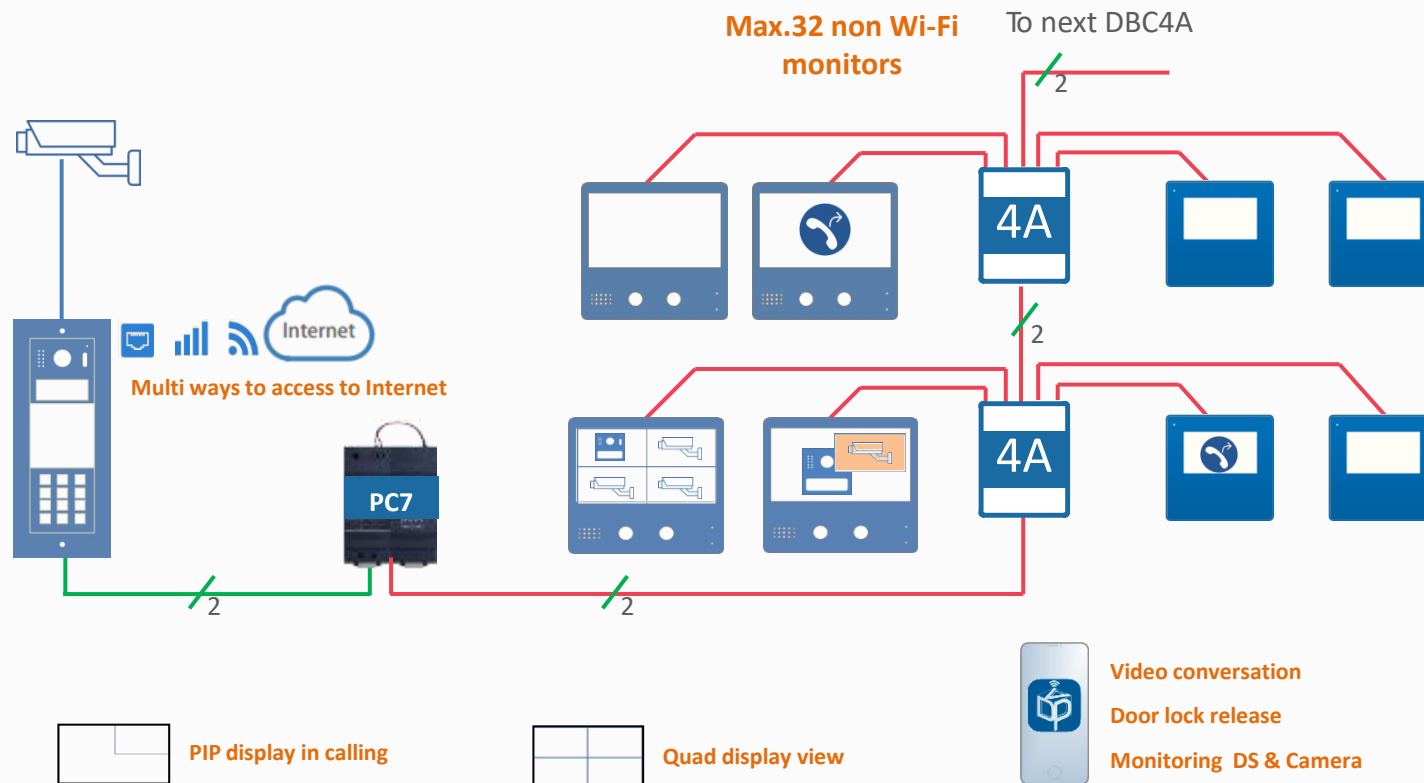

# DT616

Basic villa door station



- ↳ Slim style design
- ↳ Zinc alloy panel
- ↳ Metal Call button

- 105 ° view angle
- Auto light up sensor for night view
- Talk and unlock status indicator
- Max.400ma lock consumption
- Surface mounting
- IP54 IK07 rate

# DT610

Basic villa door station



- ↙ Compact design
- ↙ Aluminum front panel
- ↙ Big backlit push button

- 105 ° view angle(fisheye is optional)
- Voice prompt
- Auto light up sensor for night view
- Talk and unlock status indicator
- Surface mounting
- IP54 Weatherproof

# DT611

## Access control villa door station

- ↘ Stainless Steel housing(316 optional)
- ↘ Metal button
- ↘ Pin code for access



**DT611-KP**

Touch keypad



**DT611-MK**

Mechanical keypad

- Fisheye Camera(normal 105 degree is optional)
- Auto light up sensor for night view
- Talk and unlock status indicator
- Voice prompt
- Surface by rainy cover or flush mounting
- IP54 IK07 rate



# DT607

1~4 push-button villa door station



- ↘ Zinc alloy surface.
- ↘ Up to 320 RFID access.
- ↘ Intelligent Night-Light



Ref. 607F

**Flush mounting**  
Stainless steel panel

- Fish eye lens (105° lens is optional)
- 1~4 call button is optional (front panel difference)
- Voice prompt
- Flush or Surface mounting for chose
- IP54 Weatherproof

# DX821

Integrated door station

**NEW**



- ↳ Fingerprint proof stainless steel front panel
- ↳ Voice prompt
- ↳ Modularized assemble
- ↳ Dual network card embedded for Internet connectivity

LAN&WLAN version

4G version



Ref. DX821 series

821-DX Video Controller

- 170° fisheye lens camera
- High video quality
- Invisible programming button
- Public **video memory** records
- **IP camera** connectivity
- **Call divert** to mobile phone(by LAN, WALAN, 4G)
- **XD-APP control** for configuring and management
- Flush or Surface mounting for chose
- IP54 Weatherproof

# DT821

Modularized \_ Max.32 call buttons

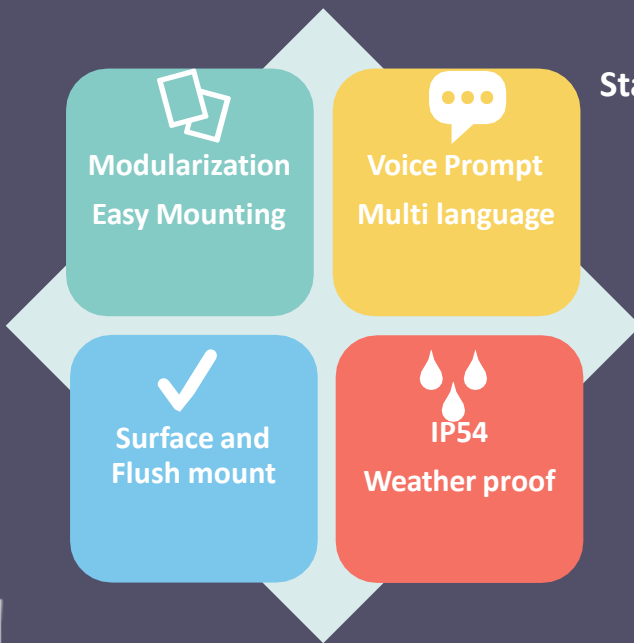

Stainless Steel

Anti-fingerprint

Logo laser printing



# DT821-Main Modules

A/V module \_ call button module

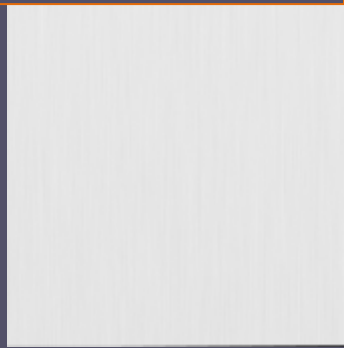
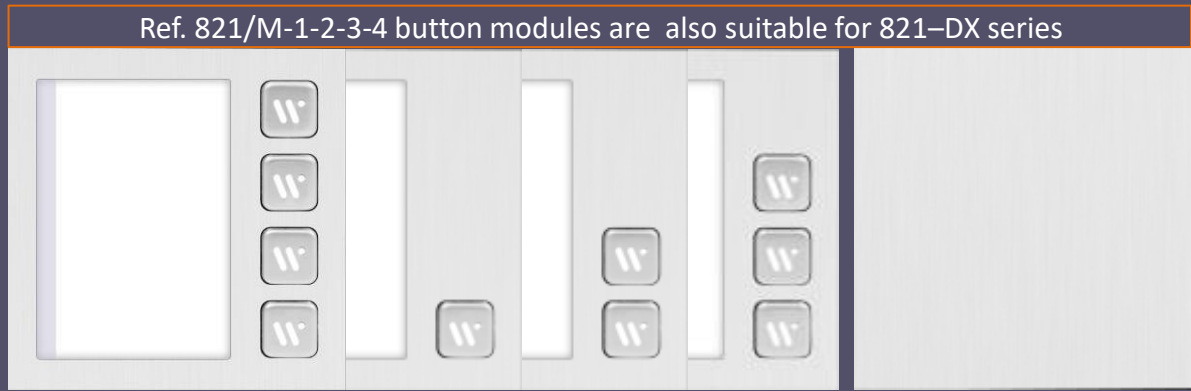

Ref. 821/VD  
Video module

Ref. 821/AD  
Audio module

Ref. 821/M4  
4 button module M1/2/3 button for option

Ref. 821/BL  
Blank module

- 170° fisheye Camera
- Led status indication
- White led auto-sensor
- Voice prompt

- Led status indication
- White led auto-sensor
- Voice prompt

- Physical push button with backlit
- Stainless steel with anti-fingerprint
- Nameplates with backlit

# DT821-Functional Modules

Display \_ RFID \_ Information \_ Keypad

Ref. 821-DR/LB/MK modules are also suitable for 821-DX series

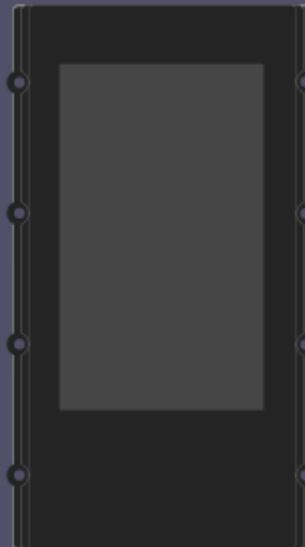
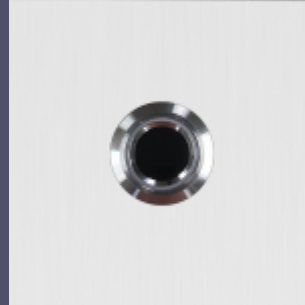
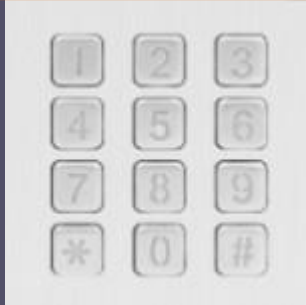

Ref. 821/TFT  
3.5" TFT module

Ref. 821/DR  
Digital display &  
proximity reader

Ref. 821/LB  
Information module

Ref. 821/MK  
Keypad module

Ref. 821/FP  
Fingerprint module

Ref. 821/T5  
Display module &  
proximity reader

3.5" TFT screen  
Name-list Calling  
Logo advertisement  
Operation method

RFID reader  
EM &MI fare  
Digital display tube  
PMMA panel

Luminous plate  
Light sense

Mechanical keypad  
Pin code access  
Backlit display  
Calling button module

Mechanical keypad  
Pin code access  
Backlit display

5" TFT display  
Touch screen  
EM & My fare  
reader

# Audio phone

Handset, hands free



Ref. DJ4A

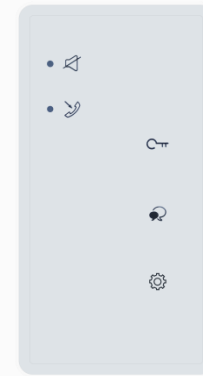

Ref. DJ9A

- Max.128 audio phone in full audio system
- In-out diagram w/o floor distributor in audio only system
- Can be mix-installed with video intercom

# Basic project-monitor

Slim \_ OSD display \_ Perfect for project

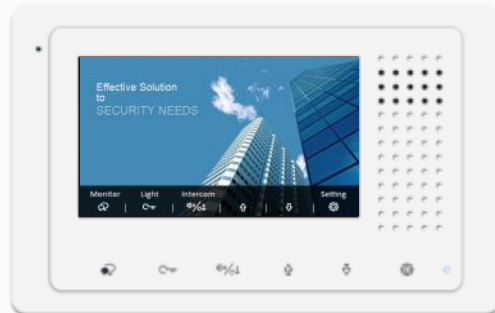

Ref. DT433

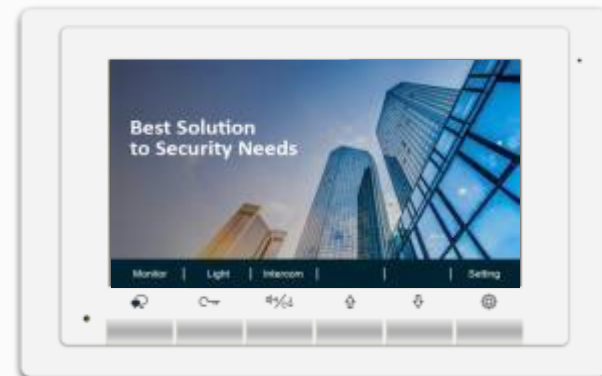

Ref. DT17S

- 4.3 inch \_ **Slim** \_ Wall **mounting w/o bracket**
- 7 inch \_ Silver sensor button \_ **Multi languages**
- \* **IP camera surveillance & Video memory view & Call divert** to mobile phone (by work with DX door stations)

# Basic standard-monitor

Slim \_ OSD/Icon display \_ Europe-style



Ref. DT437



Ref. DT471

- 4.3 inch \_ **OSD** menu \_ **Multi languages**
- 7 inch \_ **Touch screen** operation \_ **Color icon** menu
- **Handset add-on** for chose(bigger bracket)
- \* **IP camera surveillance & Video memory view & Call divert** to mobile phone (by work with DX door stations)



Monitor with DJ401 handset



# Wi-Fi monitor with memory

HD screen \_ IPC integration \_ Memory \_ Call transfer



Ref. DX471S

Ref. DX482

- 7" TFT **HD Screen** (1280\*600pixels) \_ **Wider view** angle \_ Touch screen
- **720P Video recording** \_ **3~10s memory** against with or w/o SD card
- IP camera connect \_ **PIP & Quad split display**
- Wi-Fi connectivity \_ **Call divert** with VDP Connect APP

# Wi-Fi monitor with memory

HD screen \_ IPC integration \_ Memory \_ Call transfer



Ref. DX470

- 7" TFT IPS Screen(1280\*600) \_ **Wider view** angle \_ Touch screen
- Video recording \_ **Landscape & Portrait display** under same bracket
- IP camera connecting \_ **PIP & Quad split display**
- Wi-Fi connectivity \_ **Call divert** with VDP Connect APP

# APP Solution for Users

Call answer \_ Door & Camera surveillance \_ Lock release



**VDP Connect app**

Used for two wire and IP system

- Max.5 mobile phones ring simultaneously
- Monitor screen on during diverting
- Free of email registration
- IOS and Android
- Privacy protection
- Multi languages

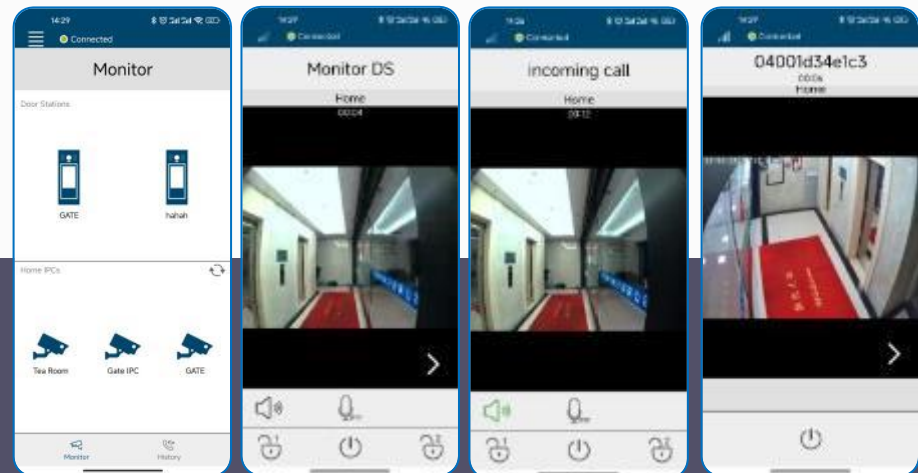

Main menu  
in Standby

Door station  
Monitoring

Incoming call  
Diverting

IP Camera  
Monitoring

# APP Solution for Installers

Tool management \_ Cell phone control \_ Wireless connection



**XD Device APP**

Used for two wire DX door stations



- Remotely control Door station from APP
- Fast configuration and System Management
- Wire or Wireless network connections(Hotspot, LAN, WLAN)

- Service list:
  - General info of device
  - Network configure \_ IP camera configure
  - Firmware online update
  - Access card & Pin code management
  - Shell command menu for collaboration

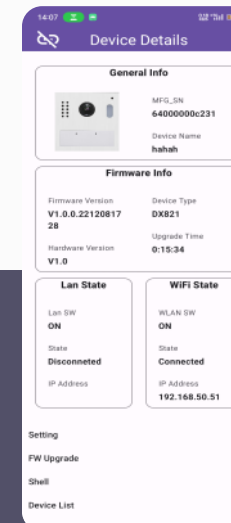

Device Details  
Setting menu



Shell Control  
Commands

# OEM customization & ODM development



INFO@V-TEC.COM.CN

WWW.V-TEC.CN

What's new :

<https://2easy-wiki.atlassian.net/wiki/spaces/2EASYWIKI/overview>