



automatiz I si elektronik k  
automata kapuk



ELECTRONICS FOR AUTOMATION  
AUTOMATIC GATES

ELETRONICA PER AUTOMATISMI  
CANCELLI AUTOMATICI



[www.tecnoautomazione.com](http://www.tecnoautomazione.com)



A **T.A. TecnoAutomazione** 1984 óta tervez és gyárt kapuautomatizálási rendszerekben használatos elektronikus és mechanikus eszközöket. A cég kezdetekben épület behatolásjelző-rendszerekre összpontosított, majd korai tevékenységét egységesítve fokozatosan váltotta fel az ipari automatizálással kapcsolatos speciális tevékenységgel. Manapság a **T.A.** teljesen házon belül tervezi és készíti a szoftvert és az összes - a teljes automatizálási folyamatot magában foglaló mechanikai és elektronikai - technológiákat. Az új növekedési elképzeléseinek részeként, 2009-ben a társaság új és funkcionálisabb épületbe költözött (A1 autópálya Colleferro kijárat), a termelési kapacitás növelése és új szolgáltatások, mint pl. a telepítők képzése, valamint a javasolt megoldások értékelésére és tesztelésére szolgáló új kiállítási terület biztosítása céljából. Büszkén hangsúlyozzuk ki azt a tényt, hogy a működési területén bekövetkező technológiai fejlődés ellenére a társaság sohasem veszítette el kézműipari szakértelmét, a termelési eljárás minden egyes, a hardver, a szoftver és a mechanika kialakításával kezdődő lépések gondos kezelésétől, a vevőknek a legmagasabb minőséget garantáló végső ellenőrzésig. **Hirnevünket alátámasztja a világszerte jelenleg több mint 500.000 helyen megtalálható, technológia megoldásainkat használó kapu és kapumozgató rendszer.**

Since 1984 **T.A. Tecno Automazione** has been designing and building electronic and mechanical devices for gate automation systems. The company focused initially on building anti-intrusion systems then integrated the early activity and gradually replaced it with activities specific to the industrial automation context. Today as then **T.A.** designs and builds totally in-house the software and all the mechanical and electronic technologies involved in the whole automation process. Since 2009 and as part of the new expansive vision of the group, the company moved to its new and more functional premises (Exit Colleferro of highway A1) to enhance its productive capacity and to offer new services such as installer training and a new exhibition area to test and assess the proposed solutions. We are very proud to highlight the fact that the company has never lost its artisanal skills despite the technological advancement of the field in which it operates by treating carefully every step of the production process starting from the hardware, the software design and the mechanical construction to the final check-outs to provide the customers with the highest quality results. **Our reputation has meant that there are currently more than 500.000 gates and opening systems all over the world that are actually handled by our technological solutions.**

**T.A. Tecno Automazione** dal 1984 progetta e costruisce l'elettronica e la meccanica per gli impianti di automazione dei cancelli. L'azienda, inizialmente focalizzata nella progettazione e produzione di sistemi di antintrusione, negli anni a seguire ha integrato l'attività iniziale fino a sostituirla con attività specifiche nell'ambito dell'automazione industriale. Oggi come ieri **T.A.** progetta e costruisce interamente al suo interno l'elettronica, il software e la meccanica necessaria a coprire l'intero comparto dell'automazione dei cancelli. La società nell'ambito di una nuova e ulteriore fase espansiva, nel 2009 si è trasferita nelle sue nuove sedi di Paliano (uscita autostrada A1 di Colleferro), ampliando la propria capacità produttiva e mettendo a disposizione dei clienti nuovi servizi, quali l'attività di training ed uno spazio espositivo dove è possibile valutare e testare i prodotti e le soluzioni proposte. Ci fa piacere evidenziare come la nostra azienda, pur operando in un settore tecnologicamente avanzato non ha mai smarrito la sua vocazione artigianale, prestando la massima cura in ogni fase del processo produttivo: dalla progettazione hardware, software e meccanica, fino al collaudo finale, offrendo alla clientela prodotti dalle grandi prestazioni, dal design tipicamente italiano e di assoluta affidabilità. **Oltre 500.000 cancelli e sistemi di chiusura installati in tutto il mondo sono gestiti dalle nostre soluzioni tecnologiche.**





index  
indice

## TARTALOMJEGYZÉK

1	távvezérlő <b>CREMINO</b> - cod. TLCNC5T	transmitter - <i>trasmettitore</i>
2	távvezérlő <b>LILLYPUT</b> - cod. TLCNL5T	transmitter - <i>trasmettitore</i>
3	távvezérlő <b>GULLIVER</b> - cod. TLC3X5T	transmitter - <i>trasmettitore</i>
4	infrarompó <b>EVE</b> - cod. FTCFE5T	photocell - <i>fotocellula</i>
5	infrarompó <b>BABY EVE</b> - cod. FTCBE5T	photocell - <i>fotocellula</i>
6	infrarompó <b>OVALE</b> - cod. FTCCX5T	photocell - <i>fotocellula</i>
7	figyelmeztetőlámpa <b>ONE UP</b> - cod. LMPOU5T / LMPD5T	flashing lamp - <i>lampeggiatore</i>
8	szárnyaskapu vezérlőegység <b>T011A OD</b> - cod. CNTBR5T OD / KITBR5T OD	control unit for swing gates - <i>centrale battente</i>
9	tolókapu vezérlőegység <b>T011S OD</b> - cod. CNTSR5T OD / KITSR5T OD	control unit for sliding gates - <i>centrale scorrevole</i>
10	rádióantenna - cod. RANRC5T	radio antenna - <i>radio antenna</i>
11	fogasléc - cod. CREFX4T	rack - <i>cremagliera</i>
12	mágneses végálláskapcsoló - cod. FNCFM5T	magnetic limit switch - <i>finecorsa magnetico</i>
13	szárnyaskapu szett - cod. KITB15T-04V / tolókapu szett - cod. KITS15T-04V	swing gates kit - sliding gates kit <i>kit battente - kit scorrevole</i>
14	kiegészítők	other products - <i>altri prodotti / accessori</i>

A fényképek a valóságtól eltérhetnek.  
T.A. fenntartja az előzetes figyelmeztetés nélküli változtatás jogát.  
The photos are not contractual.  
T.A. reserves the right to modify them without notice.  
Foto non contrattuali, T.A. si riserva il diritto di apportare tutte le modifiche necessarie senza preavviso.



elérhető színek  
colors available  
colori disponibili



Magyar  
English  
Italiano



www.tecnoautomazione.com



rev. 1.2

1



cod. TLCNC5T

transmitter  
trasmettitoretávvezérlő **CREMINO**quartz vezérelt távvezérlő öntanuló funkcióval  
quartz remote control with self-learning function  
trasmettitore quarzato ad autoapprendimentofrekvencia 433.92 MHz  
frequency 433.92 MHz  
frequenza 433.92 MHz

40 mm



15 mm

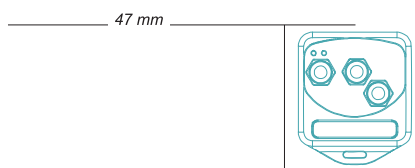

47 mm

cod. CUSTC7T

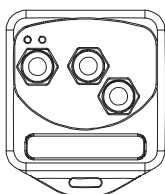
tartó  
case  
custodiakulcstartó  
keychain  
porta chiavi

www.tecnoautomazione.com



cod. TLCNL5T

transmitter  
trasmettitore

távvezérlő **LILLYPUT**

quartz vezérelt távvezérlő öntanuló funkcióval  
quartz remote control with self-learning function  
trasmettitore quarzato ad autoapprendimento

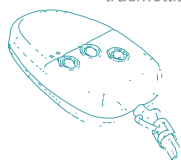

frekvencia 433.92 MHz  
frequency 433.92 MHz  
frequenza 433.92 MHz



15 mm

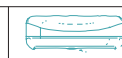

61 mm



42 mm

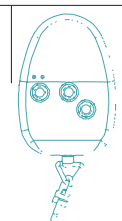

cod. CUSTC7T



tartó  
case  
custodia

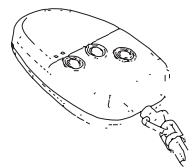
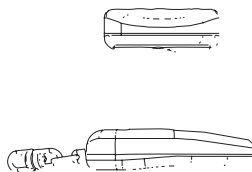
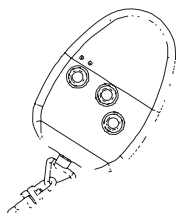

cod. TLC3X5T

transmitter  
trasmettitore



távvezérlő **GULLIVER**

quartz vezérelt távvezérlő  
quartz transmitter  
trasmettitore quarzato

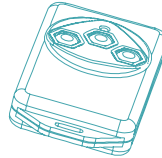

DIP kapcsolós kódolás  
DIP switch encoding  
codifica a DIP switch

frekvencia 433.92 MHz  
frequency 433.92 MHz  
frequenza 433.92 MHz

40 mm



14 mm



73 mm

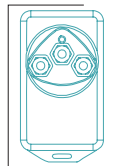

cod. CUSTC7T

tartó  
case  
custodia

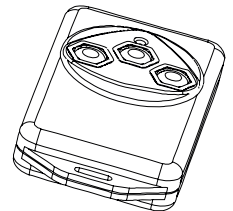
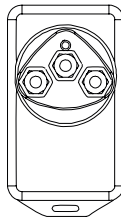

kulcstartó  
keychain  
porta chiavi





cod. FTCFE5T

photocell  
fotocellula

**infrarompó EVE**

infravörös sorompó  
infrared photocell  
fotocellula a raggi infrarossi

tápfeszültség 12/24 V  
power supply 12/24 V  
alimentazione 12/24 V

modulált infravörös jel  
signal infrared modulated  
segnale infrarosso modulato

működési távolság 40 m  
range 40 m  
portata 40 m

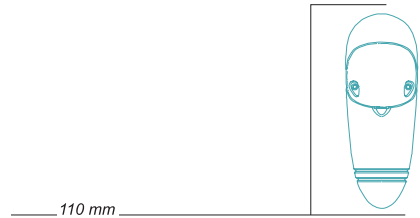
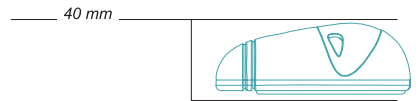
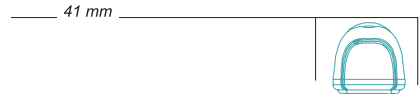
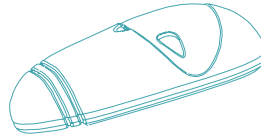

TX+RX

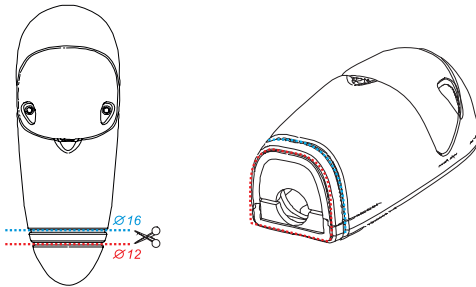

Az **EVE** egy 12 - 16 mm-es gégecsővel történő, gyors felszerelést biztosító vágási vonallal rendelkezik

**EVE** is fitted with a cut line to allow a quick installation for a 12 - 16 mm diameter corrugated pipe

**EVE** è dotata di guide di taglio che consentono installazioni veloci per corrugati di diametro 12 - 16 mm



www.tecnoautomazione.com



5



cod. FTCBE5T

photocell  
fotocellula

infrarompó **BABY EVE**

infravörös sorompó  
infrared photocell  
fotocellula a raggi infrarossi

tápfeszültség 12/24 V  
power supply 12/24 V  
alimentazione 12/24 V

modulált infravörös jel  
signal infrared modulated  
segnale infrarosso modulato

működési távolság 40 m  
range 40 m  
portata 40 m

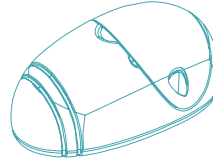

47 mm



40 mm

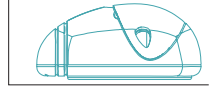

TX+RX

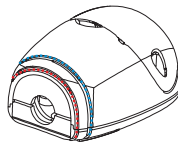
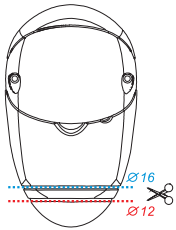

88 mm

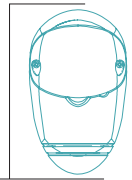

A **BABY EVE** egy 12 - 16 mm-es gégecsővekkel történő, gyors felszerelést biztosító vágási vonallal rendelkezik

**BABY EVE** is fitted with a cut line to allow a quick installation for a 12 - 16 mm diameter corrugated pipe

**BABY EVE** è dotata di guide di taglio che consentono installazioni veloci per corrugati di diametro 12 - 16 mm



www.tecnoautomazione.com







cod. FTCCX5T

photocell  
fotocellula

*infrarompó* **OVALE**

infravörös sorompó  
infrared photocell  
*fotocellula a raggi infrarossi*

tápfeszültség 12/24 V  
power supply 12/24 V  
*alimentazione 12/24 V*

modulált infravörös jel  
signal infrared modulated  
*segnale infrarosso modulato*

működési távolság 40 m  
range 40 m  
*portata 40 m*

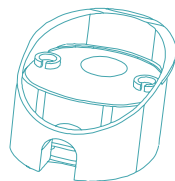

48 mm



90 mm

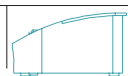

65 mm

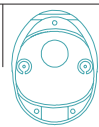

TX+RX

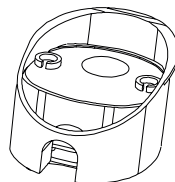
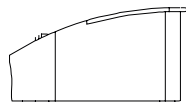
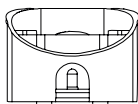
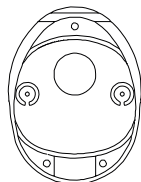

www.tecnoautomazione.com



cod. LMPOU5T

cod. LMPOD5T  
flashing lamp  
lampeggiatore

**figyelmeztetőlámpa ONE UP**

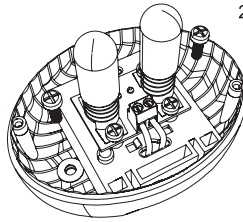

2 db 10 W-os lámpával felszerelt - tápfeszültség 24 V  
equipped with 2 lamps 10 W - power supply 24 V  
equipaggiato con 2 lampade da 24 V - 10 W

cod. LMPOU5T

cod. LMPOD5T

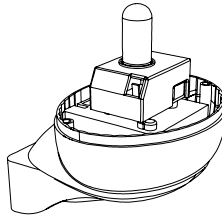

1 db 20 W-os lámpával felszerelt - tápfeszültség 230 V  
equipped with 1 lamp 20 W - power supply 230 V  
equipaggiato con 1 lampada da 230 V - 20 W

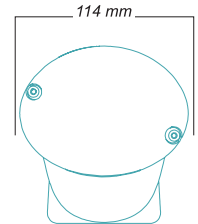
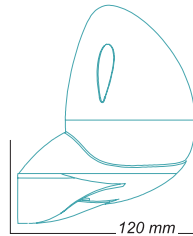
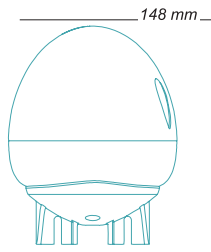

külső rádióantennával is szerelhető  
possible configuration with the outdoor radio antenna  
possibile configurazione con radio antenna da esterno

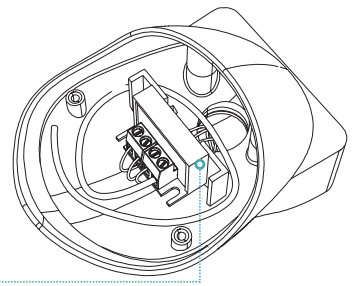
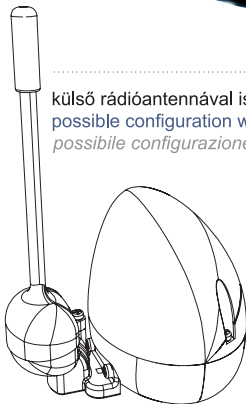

rádióvevő a figyelmeztetőlámpa belsejébe szerelhető  
possible installation of the radio receiver inside the flashing lamp  
possibile installazione del ricevitore radio all'interno del lampeggiatore

\* cod. RANRC5T pag.10



www.tecnoautomazione.com





cod. CNTBR5T *OD*

control unit for swing gates  
centrale di comando per cancelli a battente

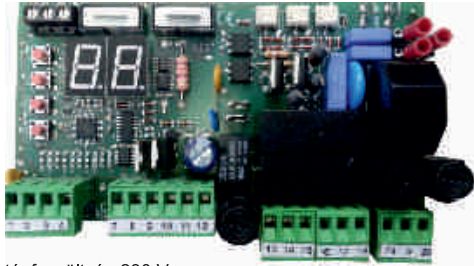

tápfeszültség 230 V  
power supply 230 V  
alimentazione 230 V

**AKADÁLYÉRZÉKELÉssel**  
**WITH OBSTACLE DETECTION SENSOR**  
**CON SENSORE DI RILEVAMENTO OSTACOLI**

Hibaüzenet megjelenítéssel rendelkező kijelző segítségével programozható. Gyalogosnyitás, automatikus zárás, lépésről-lépésre mód, akadályérzékelő, lágyindítás, elővillogás és elektromos zár ráfeszítés funkciók. Motorteljesítmény, működési és lassítási idő digitális beállítása. 230 V tápfeszültség.

Programmable using a display with error notification. Pedestrian opening function, automatic closing, step-by-step mode, obstacle detection sensor, soft start, pre-flashing and reversing stroke for electric lock. Digital setting of each motor power, working times and slowdown. 230 V power supply.

Programmabile tramite display con segnalazione delle anomalie. Funzione di apertura pedonale, chiusura automatica, passo-passo, condominiale, sensore di rilevamento ostacoli, partenza dolce, pre-lampeggio e colpo d'ariete. Regolazione digitale delle forze motori, dei tempi di manovra e rallentamento. Alimentazione 230 V.

cod. ELSER4T

elektromos zár vezérlő modul  
electric lock module  
modulo elettroserratura

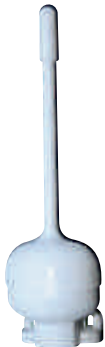

\* cod. RANPC5T pag.10



doboz  
box  
scatola

cod. SCAPL8T

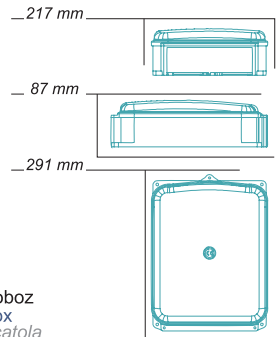

szárnyaskapu vezérlőegység **T011A OD**

szárnyaskapu elektronika szett  
electronic kit for swing gates  
kit elettronico battente

cod. KITBR5T *OD*



cod. ELSER4T

cod. RANPC5T



**cod. CNTSR5T OD**

control unit for sliding gates  
centrale di comando per cancelli scorrevoli

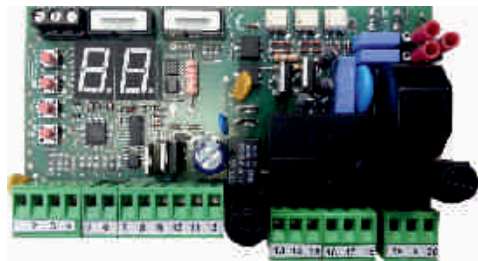

tápfeszültség 230 V  
power supply 230 V  
alimentazione 230 V

**AKADÁLYÉRZÉKELÉssel  
WITH OBSTACLE DETECTION SENSOR  
CON SENSORE DI RILEVAMENTO OSTACOLI**

Hibaüzenet megjelenítéssel rendelkező kijelző segítségével programozható. Gyalogosnyitás, automatikus zárás, lépésről-lépésre mód, akadályérzékelő, lágyindítás, elővillogás és elektromos zár ráfeszítés funkciók. Motorteljesítmény, működési és lassítási idő digitális beállítás. 230 V tápfeszültség.

Programmable using a display with error notification. Pedestrian opening function, automatic closing, step-by-step mode, obstacle detection sensor, soft start, pre-flashing and reversing stroke for electric lock. Digital setting of each motor power, working times and slowdown. 230 V power supply.

Programmabile tramite display con segnalazione delle anomalie. Funzione di apertura pedonale, chiusura automatica, passo-passo, condominiale, sensore di rilevamento ostacoli, partenza dolce, pre-lampeggio e colpo d'ariete. Regolazione digitale delle forze motori, dei tempi di manovra e rallentamento. Alimentazione 230 V.

**cod. ELSER4T**

elektromoszárr vezérlőmodul  
electric lock module  
modulo elettroserratura

**cod. RADCN4T**

radio prijemnik  
radio receiver  
ricevitore radio



frekvencia 433.92 MHz  
frequency 433.92 MHz  
frequenza 433.92 MHz

**tolókapu vezérlőegység T011S OD**

tolókapu elektronika szett  
electronic kit for swing gates  
kit elettronico battente

**cod. KITSR5T OD**

cod. ELSER4T

cod. RANPC5T

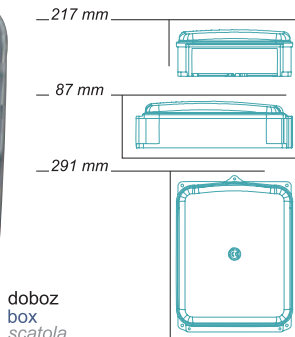
**cod. SCAPL8T**

doboz  
box  
scatola





cod. RANRC5T

radio antenna  
radio antenna

## RÁDIÓANTENNA

külső rádióantenna  
outdoor radio antenna  
radio antenna da esterno

frekvencia 433.92 MHz  
frequency 433.92 MHz  
frequenza 433.92 MHz

5 m kábellel  
5 m cable supplied  
5 m di cavo inclusi

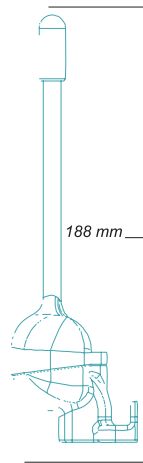
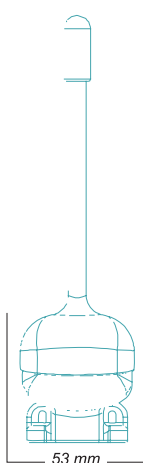
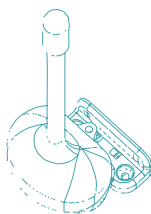
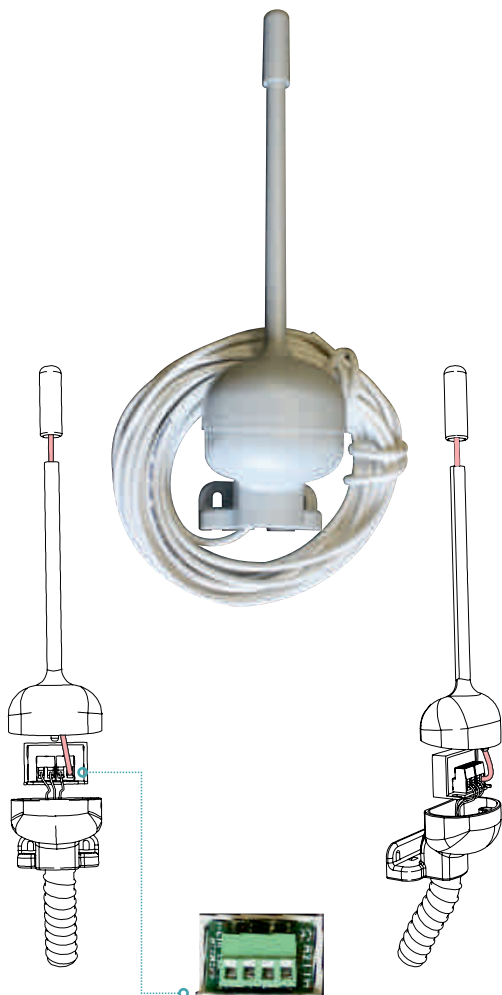

cod. RANPC5T

ház külső rádióvevőhöz  
case for outdoor radio receiver  
custodia da esterno per ricevitore radio

5 m kábellel  
5 m cable supplied  
5 m di cavo inclusi

rádióvevőt nem tartalmazza  
radio receiver not included  
ricevitore radio non incluso

házba szerelt rádióvevő  
radio receiver inside the case  
ricevitore radio all'interno della custodia



cod. CREFX4T

rack  
cremagliera

**FOGASLÉC**

moduláris műanyag fogasléc  
nylon modular rack  
cremagliera modulare in nylon



hatszögletű acélmag  
hexagonal steel core  
anima esagonale in ferro

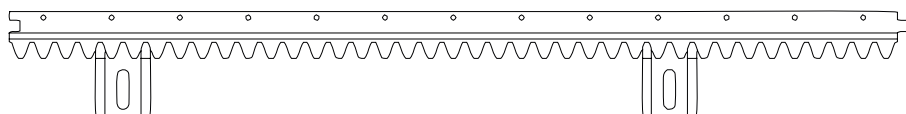
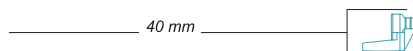
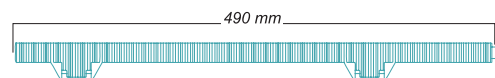
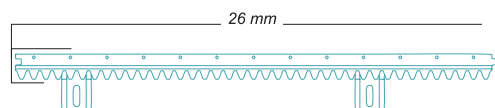

cod. FNCMM5T



mechanikus végálláskapcsoló  
mechanical limit switch  
finecorsa meccanico

fogasléc szett  
rack kit  
kit cremagliera

cod. CREFX5T

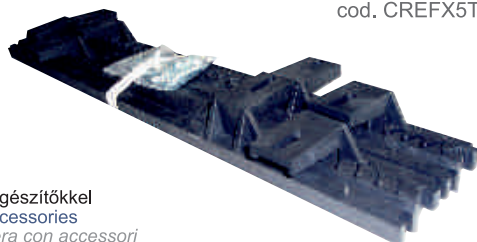

2 m fogasléc kiegészítővel  
2 m rack with accessories  
2 m di cremagliera con accessori





cod. FNCMF5T

magnetic limit switch  
*fincorsa magnetico*

## MÁGNESES VÉGÁLLÁSKAPCSOLÓ

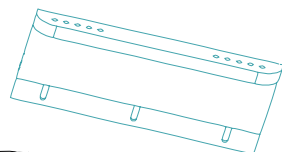

magas tartó  
high bracket  
*staffa alta*

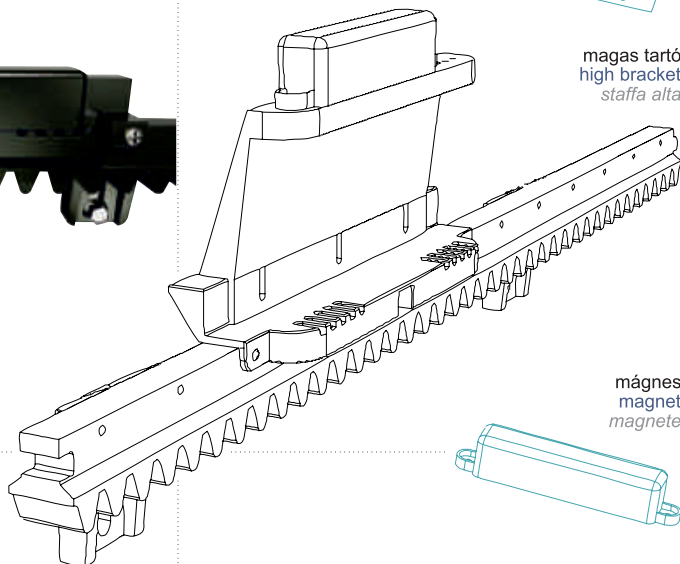

mágnes  
magnet  
*magnete*

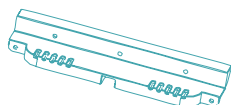

alacsony tartó  
low bracket  
*staffa bassa*

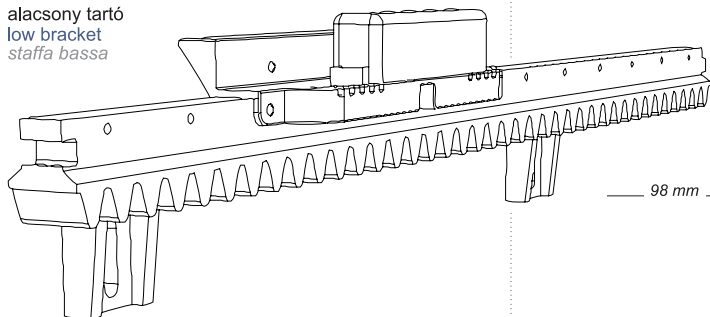

20 mm



98 mm



16 mm



cod. KITB15T-04V

swing gates kit  
kit battente

**SZÁRNYASKAPU SZETT**

**230 V**



**ÖSSZETÉTEL ÉS JELLEMZŐK**

COMPOSITION AND CHARACTERISTICS

COMPOSIZIONE E CARATTERISTICHE

1 SZÁRNYASKAPU ELEKTRONIKA SZETT **T011A OD** cod. KITBR5T OD

electronic kit for swing gates

2 TÁVVEZÉRLŐK **CREMINO** cod. TLCNC5T

kit elettronico battente

transmitters - trasmettitori

1 PÁR INFRASOROMPÓ cod. FTCFE5T / **BABY EVE** cod. FTCBE5T

pair of photocells - coppia di fotocellule

1 FIGYELMEZTETŐLÁMPA **ONE UP** cod. LMPOU5T

flashing lamp - lampeggiatore

1 PÁR SZÁRNYASKAPU MOTOR - 3 m-es kapuszárny nyitása - 350 kg-os kapuszárnyankénti teherbírás

pair of swing motors - leaf opening 3 m - capacity 350 kg per leaf  
coppia di motori a battente - apertura anta 3 m - portata anta 350 Kg

cod. KITS15T-04V

sliding gates kit  
kit scorrevole

**TOLÓKAPU SZETT**

**230 V**



**ÖSSZETÉTEL ÉS JELLEMZŐK**

COMPOSITION AND CHARACTERISTICS

COMPOSIZIONE E CARATTERISTICHE

1 TOLÓKAPU ELEKTRONIKA SZETT **T011S OD** cod. KITSR5T OD

electronic kit for sliding gates

2 TÁVVEZÉRLŐK **CREMINO** cod. TLCNC5T

kit elettronico scorrevole

transmitters - trasmettitori

1 PÁR INFRASOROMPÓ cod. FTCFE5T / **BABY EVE** cod. FTCBE5T

pair of photocells - coppia di fotocellule

1 FIGYELMEZTETŐLÁMPA **ONE UP** cod. LMPOU5T

flashing lamp - lampeggiatore

2 FOGASLÉC SZETT cod. CREFX5T

rack kit - kit cremagliera

2 MECHANIKUS VÉGÁLLÁSKAPCSOLÓ cod. FNCMM5T

mechanical limit switches - finecorsa meccanici

1 TOLÓKAPU MOTOR - 500 kg teherbírású

sliding motor with a 500 kg capacity - motore scorrevole - portata 500 Kg







other products  
altri prodotti / accessori

## KIEGÉSZÍTŐK

cod. RADA14T



1 csatornás rádióvevő öntanuló funkcióval  
1 channel radio receiver with self-learning function  
*ricevente radio 1 canale ad autoapprendimento*

frekvencia 433.92 MHz  
frequency 433.92 MHz  
frekvencia 433.92 MHz

tápfeszültség 12/24 V  
power supply 12/24 V  
alimentazione 12/24 V

cod. RADAD4T



3 csatornás rádióvevő öntanuló funkcióval  
3 channel radio receiver with self-learning function  
*ricevente radio 3 canali ad autoapprendimento*

frekvencia 433.92 MHz  
frequency 433.92 MHz  
frekvencia 433.92 MHz

tápfeszültség 12 V  
power supply 12 V  
alimentazione 12 V

cod. RADAV4T



3 csatornás rádióvevő öntanuló funkcióval  
3 channel radio receiver with self-learning function  
*ricevente radio 3 canali ad autoapprendimento*

frekvencia 433.92 MHz  
frequency 433.92 MHz  
frekvencia 433.92 MHz

tápfeszültség 24 V  
power supply 24 V  
alimentazione 24 V

cod. MCN4Z4T



redőnymotor vezérlőegység  
control unit for roller shutter motors  
*centrale di comando motori per tapparelle*

frekvencia 433.92 MHz  
frequency 433.92 MHz  
frekvencia 433.92 MHz

tápfeszültség 230 V  
power supply 230 V  
alimentazione 230 V

cod. MCN4U4T



világítás vezérlőegység  
control unit for step by step lightening  
*centrale di comando luci passo-passo*

frekvencia 433.92 MHz  
frequency 433.92 MHz  
frekvencia 433.92 MHz

tápfeszültség 230 V  
power supply 230 V  
alimentazione 230 V

cod. CREPX5T



moduláris műanyag fogasléc - 20 cm-es rúd  
nylon modular rack - 20 cm bar  
*cremagliera modulare in nylon - barra da 20 cm*





note  
note

## JEGYZET





#### Kedves Vásárló!

A katalógus előszavában néhány, cégünk történelméről szóló információt találhatott. Ezen dokumentum összefoglalásaként elmondhatjuk, hogy a **T.A. Tecno Automazione** a jövőre és tervekre tekintve elkötelezett, hogy továbbra is folytassa vásárlói számára a legmegbízhatóbb és legmasszívabb, egyszerűen használható termékek biztosítását, ahol a technika "csendben" és kitaróan végzi dolgát.

#### Dear customer,

in the foreword of this catalog, we have provided you with some information about our history. Now, in conclusion to this document an almost ideally looking to the future and to the projects that **T.A. Tecno Automazione** is going to undertake, we are committed to continue to provide our customers with the most reliable and robust products for an easy use where the technology will perform "silently" its task and stay at their service.

#### Gentile cliente,

*nella prefazione che ha trovato in questo catalogo le abbiamo fornito alcune informazioni riguardo la nostra storia. Ora, alla fine di questo documento, quasi idealmente guardando al futuro e ai progetti che **T.A. Tecno Automazione** ha in programma ed in cantiere, le anticipiamo che l'impegno prosegue nel fornire alla clientela prodotti ben costruiti, robusti e semplici da usare, dove la tecnologia, sempre all'avanguardia, continuerà a svolgere il proprio compito "in silenzio" mettendosi al servizio dei nostri clienti.*



[www.tecnoautomazione.com](http://www.tecnoautomazione.com)



[www.tecnoautomazione.com](http://www.tecnoautomazione.com)

Blank lined area for contact information or notes.

T.A. Tecno Automazione srl  
Via Vicinale snc  
Località Cervinara  
03018 - Paliano - (FR) - Italy  
Tel +39 0775 533677  
Fax +39 0775 533299  
[info@tecnoautomazione.com](mailto:info@tecnoautomazione.com)  
[commerciale@tecnoautomazione.com](mailto:commerciale@tecnoautomazione.com)

 [facebook.com/tecnoautomazione](https://facebook.com/tecnoautomazione)

 [twitter.com/tecnoautomation](https://twitter.com/tecnoautomation)

 [youtube.com/tecnoautomazione](https://youtube.com/tecnoautomazione)



MADE IN ITALY

