

# Pager4 Pager4 PRO

## INSTALLATION AND USER MANUAL

for device version v4.00 and newer  
Document version: 4.00 24.04.2018



---

### Product models:

- Pager4 2G.IN4.R2
- Pager4 2G.IN6.R1
- Pager4 3G.IN4.R2
- Pager4 3G.IN6.R1
- Pager4 3GA.IN4.R2
- Pager4 3GA.IN6.R1
- Pager4 PRO 2G.IN4.R2
- Pager4 PRO 2G.IN6.R1
- Pager4 PRO 3G.IN4.R2
- Pager4 PRO 3G.IN6.R1
- Pager4 PRO 3GA.IN4.R2
- Pager4 PRO 3GA.IN6.R1

## Table of contents

1	Main functions of the product .....	3
1.1	Differences between the <i>Pager4</i> and the <i>Pager4 PRO</i> models .....	3
1.2	Differences between the 2G, 3G and the 3GA models .....	3
1.3	Differences between the IN4.R2 and the IN6.R1 models .....	4
2	Connecting the terminals and putting into operation .....	4
2.1	Under Voltage Lock Out (UVLO) function .....	4
2.2	Input wiring .....	4
2.3	Output wiring .....	4
2.4	Connections and wiring (IN4.R2 model) .....	5
2.5	Connections and wiring (IN6.R1 model) .....	5
2.6	SIM card socket .....	6
2.7	Connecting the antenna .....	6
2.8	LED indicator .....	6
2.9	Installation .....	7
2.10	Putting into operation .....	7
2.11	Technical specification .....	7
3	General information on the notification process .....	8
4	Configuring the Pager4 .....	8
4.1	The user interface and configuration options of the software .....	8
4.2	Methods of connecting to the device .....	9
4.2.1	Configuring directly via USB .....	9
4.2.2	Remote connecting to devices via cloud service .....	10
4.2.3	Remote connecting to devices via peer-to-peer connection .....	13
4.2.4	Remote connecting to devices which are using the TEX-MVP protocol .....	14
4.2.5	Remote connecting to devices which are using the TELLMon protocol .....	15
5	How to use the Pager4 programming software .....	16
5.1	Connection menu .....	16
5.1.1	Viewing the settings options and configuring offline .....	16
5.1.2	Connection type .....	17
5.1.3	Device register .....	18
5.2	Device settings menu .....	19
5.2.1	General .....	19
5.2.2	Mobile devices (Pager4 PRO only) .....	24
5.2.3	Reporting channels .....	26
5.2.4	Notification templates .....	29
5.2.5	Inputs .....	32
5.2.6	Input events .....	34
5.2.7	Service events .....	38
5.2.8	Advanced settings .....	43
5.2.9	IP cameras (Pager4 PRO only) .....	45
5.3	Device status menu .....	47
5.3.1	Status monitoring .....	47
5.3.2	Event monitoring .....	49
5.3.3	System logs .....	51
5.3.4	Software settings .....	53
5.3.5	About .....	54
6	Controlling the device remotely by DTMF commands and text message .....	55
6.1	Remote control and status query by DTMF commands via phone call .....	55
6.2	Remote control and status query by SMS .....	56
7	Factory reset .....	58
8	Contents of the package .....	58
9	About the manufacturer .....	58

# 1 Main functions of the product

The device can be used as an accessory for alarm control panels, as an individual GSM transmitter, or as a 4/6 zone standalone alarm control device with arming/disarming option.

Main functions:

- Sends SMS, e-mail\* and Push notification\* with configurable message for each event
- Reports events by SMS, e-mail\* and Push notification\*, by voice call with recordable message, over IP to remote monitoring stations using different communication protocols and by voice call using DTMF-based Contact ID protocol.
- Reporting options:
  - SMS with configurable message up to 10 phone numbers
  - E-mail with configurable message up to 4 addresses\*
  - Push notification with configurable message up to 4 users (mobile applications)\*
  - Voice call up to 10 phone numbers with up to 15 recordable messages of 10 seconds each
  - Reporting to CMS (Central monitoring station) over IP up to 4 IP addresses using SIA IP DC-09, TELLMon and TEX protocol
  - Reporting to CMS by voice call using DTMF-based (DC-05) Contact ID protocol up to 2 phone numbers
- Up to 10 notification templates can be created and assigned to events in order to configure the priorities of reporting channels used for reporting to CMS
- Configurable Contact ID event codes for each event including partition and zone options
- Output control can be customized separately for each event using different operation modes
- Available events: input events, service/error events (new and restore as well)
- Local arming and disarming using dry contacts on inputs (with optional keyswitch, RF remote controller or access control keypad with relay output)
- Remote arming and disarming, status query and output control by phone call and SMS, as well as through the Internet using the mobile application\*
- IP camera support: forwarding the links of up to 4 IP cameras by e-mail and Push notification along with the alarm messages

\* available in the **PRO** model only

## 1.1 Differences between the *Pager4* and the *Pager4 PRO* models

There are differences in function between the **Pager4** and the **Pager4 PRO** product models. The **Pager4 PRO** includes the following extra functions:

- E-mail notification
- Push notification
- **TELL Control Center** multiplatform mobile application (iOS and Android)
- IP camera support

## 1.2 Differences between the 2G, 3G and the 3GA models

The only difference between the 2G and the 3G model is the type of the GSM module used. The 3G (UMTS) communication makes possible higher speed, thereby increasing the speed of reporting. The 2G and the 3G models can be used in Europe, while the 3GA model is equipped with a pentaband UMTS/HSPA modem that can be used worldwide. There is no difference between the three models with regard to the available functions or configuration.

### 1.3 Differences between the IN4.R2 and the IN6.R1 models

The **IN4.R2** model comes with 4 contact inputs (IN1 to IN4) and 2 relay outputs (OUT1, OUT2), while the **IN6.R1** has 6 contact inputs (IN1 to IN6) and 1 relay output (OUT1).

## 2 Connecting the terminals and putting into operation

**Attention! Do NOT connect the metallic parts of the GSM antenna connector or the terminals of the device directly or indirectly to the protective ground, because this may damage the device!**

### 2.1 Under Voltage Lock Out (UVLO) function



The product is provided with built-in automatic power disconnection (Under Voltage Lock Out) function. Depending on the product type, if the supply voltage drops below 8.4...8.2V, the device turns off automatically and it turns back on when the supply voltage is at least 11.2...11.4V.

**The minimum supply voltage level required to turn the device on is 11.2...11.4V! After turned on with supply voltage higher than 11.2...11.4V, the device can operate stably even at lower supply voltage, but not lower than 8.4...8.2V.**

If the device is powered from a power supply provided with a backup battery and there is no other electrical load on the battery when charging fails (e.g. in case of a power cut), while the battery discharges, the device turns off automatically at 8.4...8.2V voltage level.

Thereafter, if the battery is in good condition, it can regenerate and can reach the terminal voltage of 11.2...11.4V where the device turns back on, then the battery may discharge again below 8.4...8.2V. This may result a continuous switching on and off cycle that lasts until the battery can no longer regenerate to the 11.2...11.4V voltage level. If this phenomenon occurs, the battery is flat and it should be replaced.

### 2.2 Input wiring

For the inputs, the normally closed or normally open dry contact should be connected between the given input (**IN1...IN4/IN6**) and the negative of the power input (**V-**) terminal.

If a normally open dry contact is used to activate the input, choose the **NO** (normally open) option at the given input's settings. In this case the input becomes activated when the given input (**IN1...IN4/IN6**) and the **V-** terminal is shorted.

If a normally closed dry contact is used to activate the input, choose the **NC** (normally closed) option at the given input's settings. In this case the input becomes activated when shorting between the given input (**IN1...IN4/IN6**) and the **V-** terminal is removed.

### 2.3 Output wiring

The output provides normally open (N.O.) dry (potential free) relay contact by default and closed contact upon control.

## 2.4 Connections and wiring (IN4.R2 model)

System terminal inputs and outputs:

- V+** Supply voltage ~ / 12...30V AC/DC (min. 500 mA)
- V-** Supply voltage ~ / negative (if DC)
- IN1** Dry contact input 1
- IN2** Dry contact input 2
- IN3** Dry contact input 3
- IN4** Dry contact input 4
- OUT1** Relay output 1 (normally open dry contact)
- OUT2** Relay output 2 (normally open dry contact)

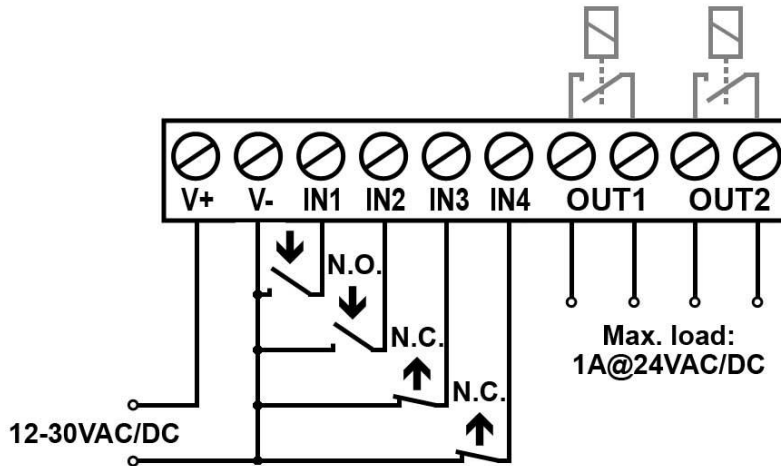
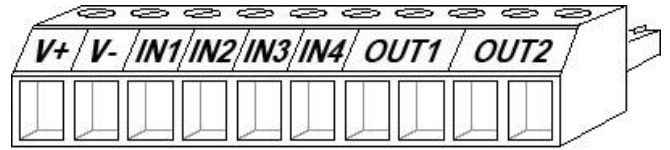

## 2.5 Connections and wiring (IN6.R1 model)

System terminal inputs and outputs:

- V+** Supply voltage ~ / 12...30V AC/DC (min. 500 mA)
- V-** Supply voltage ~ / negative (if DC)
- IN1** Dry contact input 1
- IN2** Dry contact input 2
- IN3** Dry contact input 3
- IN4** Dry contact input 4
- IN5** Dry contact input 5
- IN6** Dry contact input 6
- OUT1** Relay output (normally open dry contact)

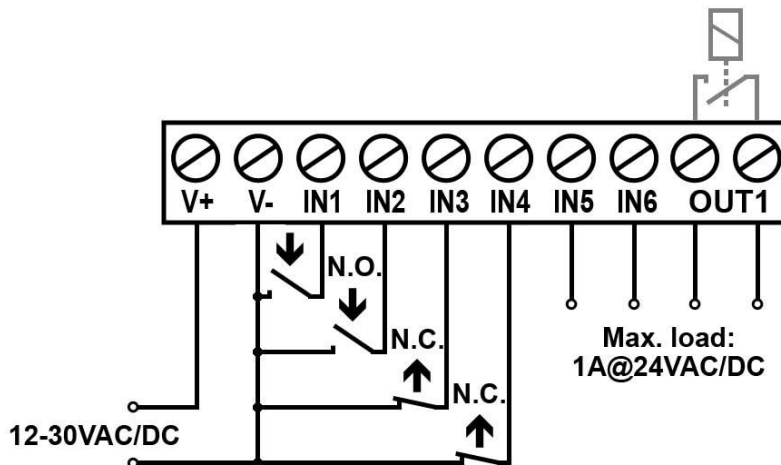
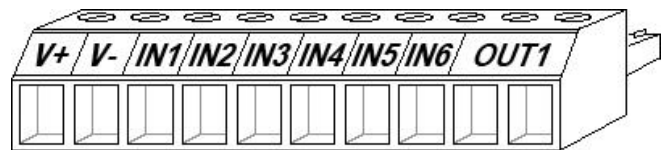

## 2.6 SIM card socket

The SIM card socket can be accessed by removing the cover of the aperture found on the device enclosure. The cover can be removed by pressing it with your fingernail towards the LED at the end where the gap is and then pulling it outwards. Insert the SIM card in the socket. The services to be activated on the SIM card installed into the device should be chosen according to which services of the device you wish to use. Basically, for communication with receivers and servers it requires a SIM card with mobile Internet access that may use either public or private APN. The functions that use SMS sending need SMS service and the ones that use calls require GSM voice call service.

- Installing the SIM card:

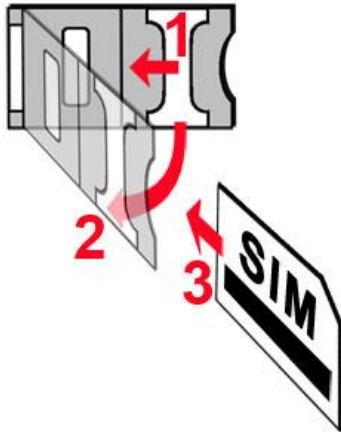

- **1.** pull the metal security lock of the SIM socket towards the LED until it clicks
- **2.** reach under the metallic security lock with your fingernail and pull it outwards to open the socket
- **3.** slide the SIM card into the opened part with the contacts facing down, as shown in the figure
- Close back the opened part together with the SIM card.
- Press down carefully the metallic security lock and pull it towards the side of the enclosure until it clicks.

## 2.7 Connecting the antenna

Connect the GSM antenna to the FME-M socket. The device comes with an antenna which provides good transmission under normal reception circumstances. In case of experiencing signal strength problems or/and wave interference (fading), use another (directed) type of antenna or find a more suitable mounting place for the antenna. In case of installing the unit into a metal box, the antenna should be mounted outside the box in a place where the measured GSM signal is the highest available.

## 2.8 LED indicator

Blinking red	The GSM service is unavailable or system startup/restart is in progress
Permanent red	SIM card error
Red blinks fast Green blinks slower	Event reporting is in progress
Green blinks slowly, Red is not lit	Connected to the GSM network, device disarmed
Green and red blink alternately	Connected to the GSM network, device armed

## 2.9 Installation

### Please check the environment before installing:

- Verify the GSM signal strength with your mobile phone. It may happen that the signal strength is not sufficient in the desired mounting place. In this case the planned installation place can be changed before mounting the device.
- Do not mount the unit in places where it could be affected by strong electromagnetic disturbances (e.g. close to electric motors, high voltage, etc.).
- Do not mount the unit in wet places or places with high degree of humidity.

## 2.10 Putting into operation

- **Disable voicemail and notification in SMS about missed calls on the SIM card installed into the device.**
- **The device can handle the SIM card's PIN code. If you wish to use the PIN code management, configure the SIM card's PIN code in the programming software at the "Settings" section. Otherwise disable PIN code request on the SIM card.**
- **Enable both caller identification and caller ID presentation (CLIP) service on the SIM card at the GSM service provider** (these services might not be enabled by default, please check). To enable these services, install the SIM card into a mobile phone and call the customer service of the card's GSM service provider and enable the services in the menu, or visit one of the service provider's personal customer services and ask to enable these services on the SIM card.
- Check the SIM card to be installed correctly into the device.
- Check the GSM antenna to be connected correctly to the device.
- Check the wires to be connected as instructed in the wiring diagram.
- You can power up the device (12...30V AC/DC). Make sure that the power source satisfy the consumption of the device. The quiescent current of the device is 120mA, however it may increase up to 500mA during communication and relay control. If the used power source is not sufficient for the operation of the device, this may cause malfunctions.

## 2.11 Technical specification

Supply voltage range:	12...30V AC/DC
Nominal current consumption:	120mA
Highest current consumption:	500mA @ 12V DC, 250mA @ 24V DC
Operating temperature:	-20°C to +70°C
Transmission frequency:	2G model: 850/900/1800/1900 MHz 3G model: 900/2100 MHz @UMTS, 900/1800 MHz @GSM 3GA model: 800/850/900/1900/2100 MHz @UMTS 850/900/1800/1900 MHz @GSM
Highest load supported on outputs:	1A @ 24VAC/DC
Modem type:	2G model: Quectel M95 3G model: Quectel UG95 3GA model: Quectel UG96
Dimensions:	84 x 72 x 32mm
Weight:	200g (packed: 300g)

### 3 General information on the notification process

Notifications are performed based on the events available in the device. Each event can be configured to send report to CMS over IP or DTMF-based voice call, as well as to send notifications to users by call or SMS. There are 2 groups of events available in the device: input events and service events. An input event is generated when an input is activated, but only if the device is armed or the given input is configured as a 24h zone. Non-24h inputs will not generate events when the device is disarmed. Service events are generated and can send notifications also when the device is disarmed. Service events are such as arming, disarming, error events, periodic test report.

When an event is generated, the device starts sending the configured notifications. The priority of notification is the following: CMS, SMS, calls.

The number of attempts for reporting to CMS have a separate logic, since reporting to CMS is based on notification templates. You can read more about this in the "[Notification templates](#)" paragraph. Regarding text message sending and calls, the device makes 3 attempts to send a message and 3 attempts to make a call to a user phone number. The device will no longer try to report events for which reporting failed for more than 24 hours.

### 4 Configuring the Pager4

The device can be configured the following ways:

- By computer via USB, using the programming software.
- By computer over the Internet, using the programming software.

The **Pager4** programming software is compatible with the following operating systems:

- **Windows 10 (32/64 bit)**
- **Windows 8.x (32/64 bit)**
- **Windows 7 (32/64 bit)**

**Installing the programming software:** open the software setup application and follow the instructions of the installation wizard to complete the installation. The latest version of the programming software can be downloaded from the manufacturer's website (<http://www.tell.hu>).

The **Pager4** programming software can be used to configure all **Pager4** device models.

#### 4.1 The user interface and configuration options of the software

The user interface language can be selected from the "**Language**" selection drop-down menu found in the "**Software settings**" / "**Settings**" menu.

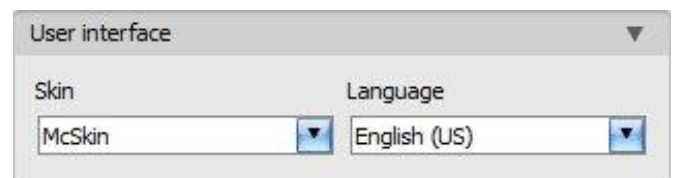

The user interface skin can be changed using the "**Skin**" dropdown-menu found in the "**Software settings**" / "**Settings**" menu, where you can choose out of multiple appearance themes.

#### Context-sensitive help:

The "**Help**" section on the right hand side of the program window opens a context-sensitive help by dragging the mouse pointer above it. You can pin the help window thus making it always visible by clicking on the "thumbtack" icon in the top right corner of the window. If you click on any of the settings fields within the program window, you will get brief information about the given option or setting in the help window. The content of the help window can be scrolled up and down using the scrollbar placed on the right hand side of the help window, or using the mouse wheel after clicking inside the help window. For better readability, the help window can be resized by dragging the left-side border of the window horizontally using the mouse.

The software saves changes related to appearance upon closing and applies the saved settings when reopened.



## 4.2 Methods of connecting to the device



For connecting to the device using the programming software, the following options are available:

**USB:** direct connection using a USB A-B cable.

**TEX-MVP:** remote connection through the Internet via the TEX-MVP server. This option can be used by central monitoring stations that own a TEX-MVP server.

**TELLMon:** remote connection through the Internet via the TELLMon receiver. This option can be used by central monitoring stations that own a TELLMon receiver.

**Cloud:** remote connection through the Internet via the cloud server operated by the manufacturer.

**Peer-to-peer:** direct remote connection via the Internet. This option can be used if the computer running the programming software and the SIM card installed into the **Pager4** device are in the same VPN or a private APN.

### 4.2.1 Configuring directly via USB

To start programming the device, follow the instructions below:

- Open the **Pager4** programming software.
- Select the USB option in the “**Connection type**” menu, power up the device and connect it to the computer using a USB A-B cable.
- Enter the connection password.
  - Super administrator permission: full access to all settings. (Default password: **1234**).
  - Administrator permission: full access to all settings except device identification settings.
  - Connecting without password: can only read settings and logs.

- Click on the “**Connect**”  button.
- If the wrong password is entered, the software connects to the device with “read only” permission.
- The software connects to the device using standard HID driver which is integrated in Windows operating systems, thus there is no need to install special USB drivers. When the device is connected to USB for the very first time, the Windows operating system installs the drivers automatically.
- The connection status is indicated by the USB status icon placed in the upper left corner of the program window:

 USB disconnected (green)

 connected via USB (grey)

- After connecting using the valid password, you can configure the device, change settings, download event logs, monitor system status and perform controls.

- To close the connection, click on “**Disconnect**”  button.

## 4.2.2 Remote connecting to devices via cloud service

This connection type can be used if the *Pager4* device you wish to connect remotely to, can use the cloud service. For this, the APN settings should be configured in the “*General*” settings menu and it is also necessary to have installed into the device a SIM card with available mobile Internet service which uses public APN, or, if using a private APN, accessing the cloud server IP address should be enabled in the given APN.

If the “*Cloud usage*” option is enabled and the cloud server availabilities are configured in the same menu, the device will be continuously online, so it can be accessed at anytime via the cloud server. Otherwise it will only connect upon request sent by SMS, as mentioned below.

With this connection type, connection between the device and the *Pager4* programming software will be established through the cloud server operated by the manufacturer.

The “*System logs*” option of the programming software cannot be used in case of remote connection over the Internet.

Connection password	Remote device availabilities			
Admin password *****	Device name	Server address	Port	Device ID
		54.75.242.103	2020	21:45:44:42:01:01

**Admin password:** the security password of the device (default superadmin password: **1234**).

**Server address:** the IP address of the cloud server (default: **54.75.242.103**).

**Port:** communication port number of the cloud server (default: **2020**)

**Device ID:** the device identifier of the *Pager4* device to which you wish to connect. The format of this unique, burned-in during production and thereby unchangeable device identifier used for cloud connection is: **FF:FF:FF:FF:FF:FF** (6x2 hexadecimal characters). You can read the device ID of the given device in the “*Device ID*” section of the “*Status monitoring*” menu, when connected to the device. The device will also send its device ID as a reply to your request for connecting to the cloud server, sent by SMS to the device, about which you can read more below.

Connecting to the device through the cloud server:

- Enter the connection password.
  - Super administrator permission: full access to all settings. (Default password: **1234**).
  - Administrator permission: full access to all settings except device identification settings.
  - Connecting without password: can only read the settings.
- In case of entering the wrong password, the software connects to the device with read-only permission.
- Select the “**Cloud**” option in the “**Connection type**” section.
- Fill in the “**Server address**”, “**Port**” and “**Device ID**” fields.

- If cloud usage is enabled in the settings of the given device, the device keeps continuous connection with the cloud server. In this case skip the SMS sending process mentioned below. Cloud usage can be enabled in the “**General**” settings menu. If cloud usage is disabled, the device will not keep continuous connection with the cloud server, it will only connect upon request. Therefore, if this is the case, before trying to connect remotely to the device, the request for connecting to the server should be sent by SMS to the phone number of the SIM card installed into the device. The device accepts the request for connecting to the cloud server from the configured and authorized user phone numbers. If the connecting request is sent from an unauthorized user phone number, or a number which is not configured in the device, the device password should be added in the message using the “**PWD**” parameter, as specified below. In case that the connecting request command is sent from unauthorized phone numbers without specifying the device password, or with the wrong password, the device will ignore the request and will not send any reply to these numbers.

Send the request command for connecting to the server (**\*CONNECT,PWD=device password#**) by SMS to the phone number of the SIM card installed into the device and wait for the device’s reply. As soon as the device connects to the server, it will send the following reply:

**Connected to** (*IP address:port number*)  
**ID=**(*device identifier*)

Using the “**PWD**” parameter is optional, according to the following:

**PWD:** the device password can be specified using this parameter. The superadmin and admin passwords are both accepted (default superadmin password: 1234). The **PWD** is an optional parameter which should be used only when sending commands from phone numbers which are not configured in the device, or from ones which are configured, but for which other than the “**Accept call and don’t request password**” option is assigned in the “**Incoming call management**” section – such phone numbers are considered unauthorized, therefore in this case the password is required).

Example on the usage of the command mentioned above:

When sending from an authorized phone number:      **\*CONNECT#**

When sending from an unauthorized phone number:    **\*CONNECT,PWD=1234#**

If cloud usage is disabled in the device settings, the device remains connected to the cloud server for 10 minutes only and thereafter in case of inactivity it disconnects automatically, therefore you have 10 minutes to connect to the device after it sends the reply message.

If no reply is received from the device within 1 or 2 minutes, please check if the settings are correct and if the circumstances of sending the request for connecting satisfy the conditions mentioned above.

Possible error messages:

<b>Missing APN</b>	the APN is not configured
<b>Network connection error</b>	the device is unable to connect to the Internet due to an error, faulty settings, or missing Internet service

If the APN or the cloud server settings are not configured in the device, or are faulty, you can configure these using the following SMS commands:

SMS command	Specification
<b>*APN=APN,PWD=device password#</b>	Configuring the APN
<b>*APN=APN,username,password,PWD=device password#</b>	Configuring the APN along with the username and password belonging to it
<b>*CONNECT=server address:port nr,PWD=device password#</b>	Configuring the cloud server address and port number, then connecting to the server





Example on the usage of the commands mentioned above:

**\*APN=internet,PWD=1234#**

**\*APN=net,guest,guest,PWD=1234#**

**\*CONNECT=54.75.242.103:2020,PWD=1234#**

Wait for the device's reply. After it has confirmed that it has connected to the cloud server, continue with the next step.

- Click on the “**Connect**”  button and wait for the connection to establish. The process of connecting may take a few seconds.
- The connection status is indicated by the status icon in the top left corner of the program window:
  -  disconnected (green)
  -  connected (gray)
- After connecting using the valid password, you can configure the device, change settings, download event logs, monitor system status and perform controls.
- To disconnect from the device click on the “**Disconnect**”  button.

### 4.2.3 Remote connecting to devices via peer-to-peer connection

This connection type can only be used in a private APN, or through a virtual private network (VPN) connected to the given private APN. In case of private APN, for the SIM cards in the given APN, sending and receiving data between each other should be enabled. The SIM card installed into the *Pager4* device you wish to connect remotely to, should have a static IP address and should be part of the given private APN, respectively VPN, just like the computer from which you wish to connect to the device. If the computer is not part of the given private APN through VPN, then you can connect to the device through a mobile Internet stick connected to the computer, in which you have to use a SIM card that is part of the given private APN. Also, the APN settings should be configured in the device you wish to connect to. These settings are available in the “*General*” settings menu.

With this connection type, connection between the device and the *Pager4* programming software will be established directly (peer-to-peer).





The “*System logs*” option of the programming software cannot be used in case of remote connection over the Internet.

Connection password	Remote device availabilities
Admin password <input type="password" value="****"/>	Device name <input type="text"/> Device IP address <input type="text"/>

**Admin password:** the security password of the device (default superadmin password: **1234**).

**Device IP address:** the static IP address of the device you wish to connect to.

Connecting to the device through peer-to-peer connection:

- Enter the connection password.
  - Super administrator permission: full access to all settings. (Default password: **1234**).
  - Administrator permission: full access to all settings except device identification settings.
  - Connecting without password: can only read the settings.
- Select the “*Peer-to-peer*” option in the “*Connection type*” section.
- Enter the static IP address of the device you wish to connect to in the “*Device IP address*” field.
- Click on the “*Connect*”  button.
- In case of entering the wrong password, the software connects to the device with read-only permission.
- The connection status is indicated by the status icon in the top left corner of the program window:
  -  disconnected (green)
  -  connected (gray)
- After connecting using the valid password, you can configure the device, change settings, download event logs, monitor system status and perform controls.
- To disconnect from the device click on the “*Disconnect*”  button.

#### 4.2.4 Remote connecting to devices which are using the TEX-MVP protocol

This connection type can be used if the *Pager4* device you wish to connect remotely to, is connected to a TEX-MVP server. Also use this connection type if the *Pager4* device is connected to a TELLMon receiver and the device is configured to communicate with the TELLMon receiver using the TEX-MVP protocol.

With this connection type, connection between the device and the *Pager4* programming software can be established through the server/receiver on which the device is online.

The “**System logs**” option of the programming software cannot be used in case of a remote connection over the Internet.

Connection password		Remote device availabilities				
Admin password		Device name	Server address	Port	Server password	Device ID
*****			194.38.104.31	3333		50E

**Admin password:** the security password of the device (default superadmin password: **1234**).





**Server address:** the IP address or domain name of the server on which the device is online.

**Port:** the communication port number (default TEX communication port: **3333**)

**Server password:** the 20 hexadecimal-character password of the TEX server (5x4 characters separated by hyphen).

**Device ID:** the “TEX” identifier of the *Pager4* to which you wish to connect to. The format of the “TEX” device identifier is: **FFF** (3 hexadecimal characters).

Connecting to the device through a server/receiver which uses the TEX protocol:

- Enter the connection password.
  - Super administrator permission: full access to all settings. (Default password: **1234**).
  - Administrator permission: full access to all settings except device identification settings.
  - Connecting without password: can only read the settings.
- Select the “**TEX-MVP**” option in the “**Connection type**” section.
- Fill in the “**Server address**”, “**Port**”, “**Server password**” and “**Device ID**” fields.
- Click the “**Connect**”  button.
- In case of entering the wrong password, the software connects to the device with read-only permission.
- The connection status is indicated by the status icon in the top left corner of the program window:
  -  disconnected (green)
  -  connected (grey)
- After connecting using the valid password, you can configure the device, change settings, download event logs, monitor system status and perform controls.
- To disconnect from the device click on the “**Disconnect**”  button.

## 4.2.5 Remote connecting to devices which are using the TELLMon protocol

This connection type can be used if the *Pager4* device you wish to connect remotely to, is connected to a TELLMon receiver and the device is configured to communicate with the TELLMon receiver using the TELLMon protocol.

With this connection type, connection between the device and the *Pager4* programming software can be established through the receiver on which the device is online.

The “**System logs**” option of the programming software cannot be used in case of remote connection over the Internet.

Connection password		Remote device availabilities			
Admin password		Device name	Receiver address	Port	Device ID
****				3535	21:45:44:42:00:00





**Admin password:** the security password of the device (default superadmin password: **1234**).

**Receiver address:** the IP address or domain name of the receiver on which the device is online.

**Port:** communication port number (the default TELLMon communication port is: **3535**)

**Device ID:** the device identifier of the *Pager4* device to which you wish to connect to. The format of this unique, burned-in during production and thereby unchangeable device identifier used for the TELLMon protocol is: **FF:FF:FF:FF:FF:FF** (6x2 hexadecimal characters).

Connecting to the device through a server/receiver which uses the TELLMon protocol:

- Enter the connection password.
  - Super administrator permission: full access to all settings. (Default password: **1234**).
  - Administrator permission: full access to all settings except device identification settings.
  - Connecting without password: can only read the settings.
- Select the “**TELLMon**” option in the “**Connection type**” section.
- Fill in the “**Receiver address**”, “**Port**” and “**Device ID**” fields.
- Click on the “**Connect**”  button.
- The *Pager4* device that communicates using the TELLMon protocol is not online continuously. The device connects to the receiver only when it sends a supervision or event message, therefore after clicking the “**Connect**” button, you have to wait until the device next connects to the receiver for sending a supervision or event message. This is when the programming software will have possibility to connect to the device. Therefore, if the device is configured to rarely send supervision messages towards the TELLMon receiver, in this case the programming software will be able to connect to the device after a long time only (depending on the interval of supervision message sending).
- In case of entering the wrong password, the software connects to the device with read-only permission.
- The connection status is indicated by the status icon in the top left corner of the program window:
  -  disconnected (green)
  -  connected (gray)
- After connecting using the valid password, you can configure the device, change settings, download event logs, monitor system status and perform controls.
- To disconnect from the device click on the “**Disconnect**”  button.

## 5 How to use the Pager4 programming software

### 5.1 Connection menu

#### 5.1.1 Viewing the settings options and configuring offline

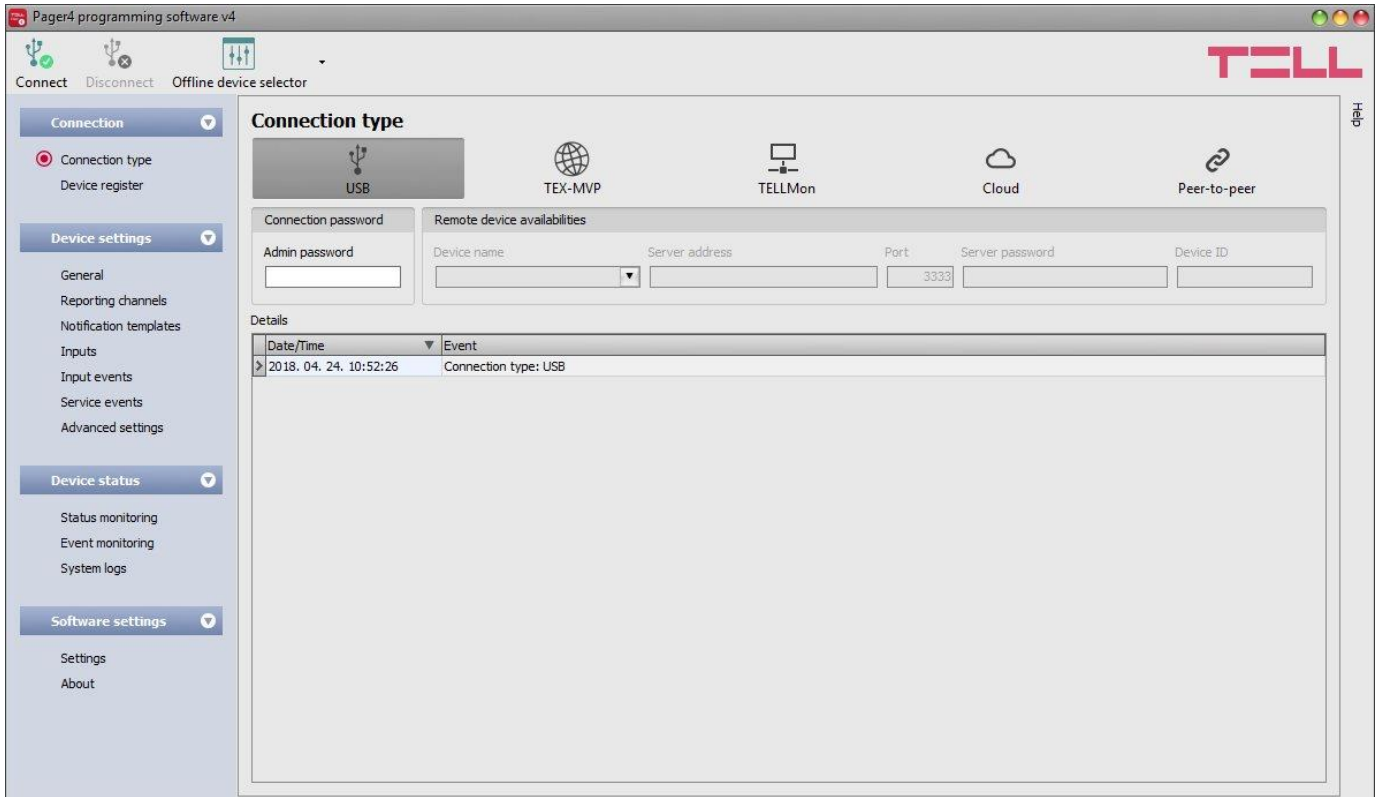

The **Pager4** programming software supports all **Pager4** device models, therefore the software shows the settings and control options available specifically in a given device model, which are different from the common parameters (e.g. differences between the **PRO** and non **PRO**, or device models with a different number of inputs) only when connecting the given device model, i.e. a **Pager4** device has to be connected in order to show the specific settings options of that device model.

However, using the “**Offline device selector**” it is possible to view the settings options of any **Pager4** device model and to configure and save the settings in advance offline, without connecting the device.

If you wish to view the settings options of a **Pager4** device model, or to configure and save settings without connecting the device, click on the arrow found next to the

“**Offline device selector**”  button, select the desired device model from the drop-down

menu and then click on the “**Offline device selector**”  button to load the settings options of the selected device model.



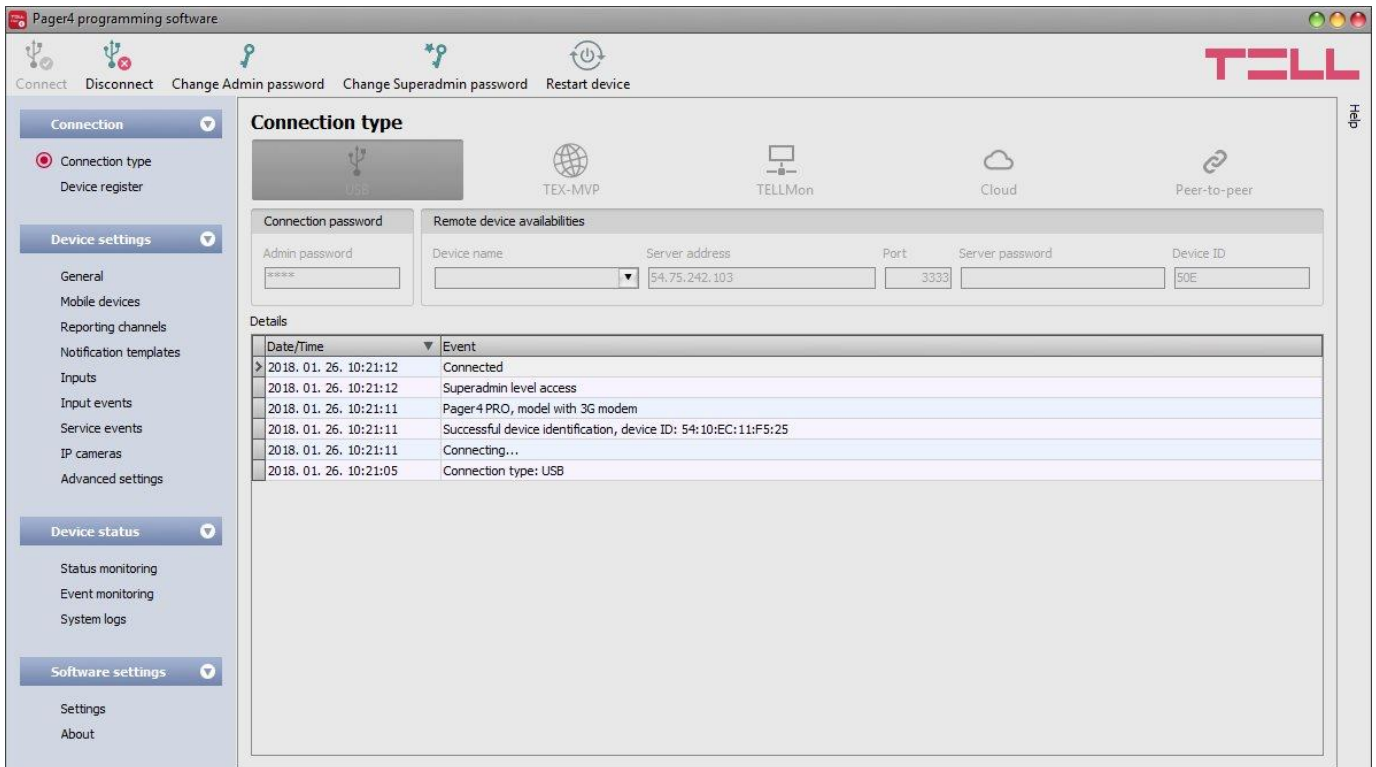

## 5.1.2 Connection type



In the “**Connection type**” menu the type of connection can be selected (USB or different options for connecting over the Internet), information can be seen about the connection process, and the admin and superadmin password can be changed. The default superadmin password is **1234**. If you wish to use the admin level access as well, for this the password should be configured separately by clicking on the “**Change Admin password**” button (for “**Actual password**” enter the superadmin password).

Available options:

- Change Admin password:  
 The administrator level password can be changed after clicking on this button.
- Change Superadmin password:  
 The superadministrator level password can be changed after clicking on this button.
- Restart device:  
 If needed, you can restart the connected device by clicking on this button.

**Changing the Superadmin password**

Actual password

New password      Confirm new password

Enter the actual password, then the new password and its confirmation, then click “**OK**”. The password should consist of at least 4, but not more than 8 characters. Accepted characters are: numbers (0...9), lower case letters (a...z), and capital letters (A...Z).

Attention! The following characters should not be used: ~ ^ < > = | \$ &.

**Details:** in this window you can follow the connection progress.

### 5.1.3 Device register

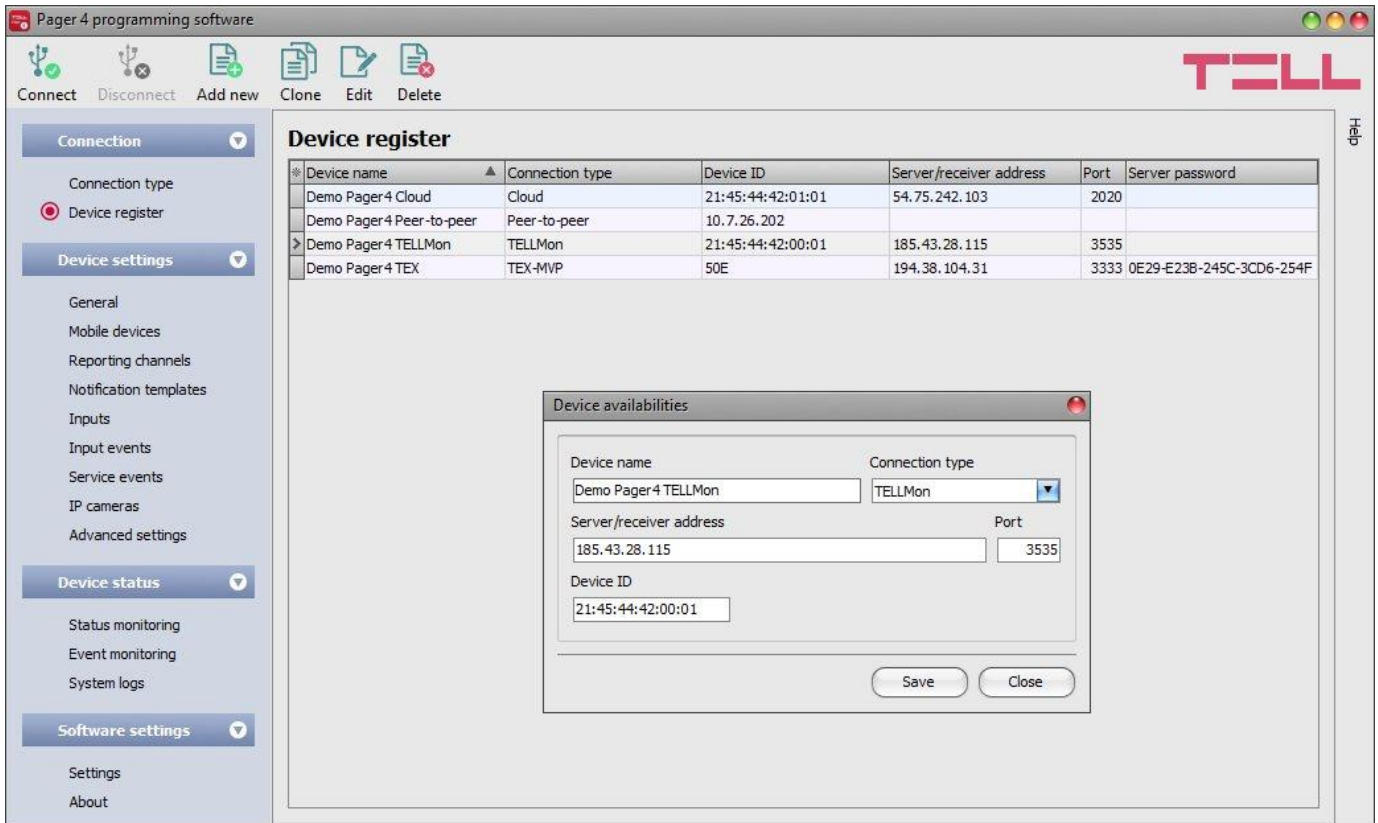

The device register serves for storing and easy handling of device availabilities used for remote programming. You can add new device availabilities to the database and also edit, delete and clone entries for easy adding of devices with similar availabilities.

When connecting remotely, you can easily select by name the device you wish to connect to from the “**Device name**” drop-down menu, out of the devices added to the database. If you add a new device availability in the connection type section, the program will add it automatically to the device register database by using the device ID as device name, which you can then change by editing the given entry. The database is stored locally on the computer.

Function buttons available in the “**Device register**” menu:



: add new device



: clone entry (duplicate)



: edit entry



: delete entry

Data stored by the device register:

**Device name:** custom name

**Connection type:** select the type of connection (TEX-MVP, TELLMon, cloud, peer-to-peer) according to the server/receiver to which the device connects to.

**Server/receiver address:** the IP address or domain name of the server/receiver

**Device IP address:** the static IP address of the device (in case of private APN)

**Port:** the communication port number of the server/receiver

**Server password:** (for TEX-MVP protocol only) the 20 hexadecimal-character server password (5x4 characters separated by hyphen)

**Device ID:** the device identifier. The format of the device identifier is:

- for cloud usage and the TELLMon protocol: **FF:FF:FF:FF:FF:FF** (6x2 hexadecimal characters, unique, burned-in during production and thereby unchangeable device identifier). The device ID (used for cloud connection and the TELLMon protocol) of the connected device is shown in the “**Status monitoring**” menu / “**Device ID**” field.
- for the TEX-MVP protocol: **FFF** (3 hexadecimal characters)

## 5.2 Device settings menu

### 5.2.1 General

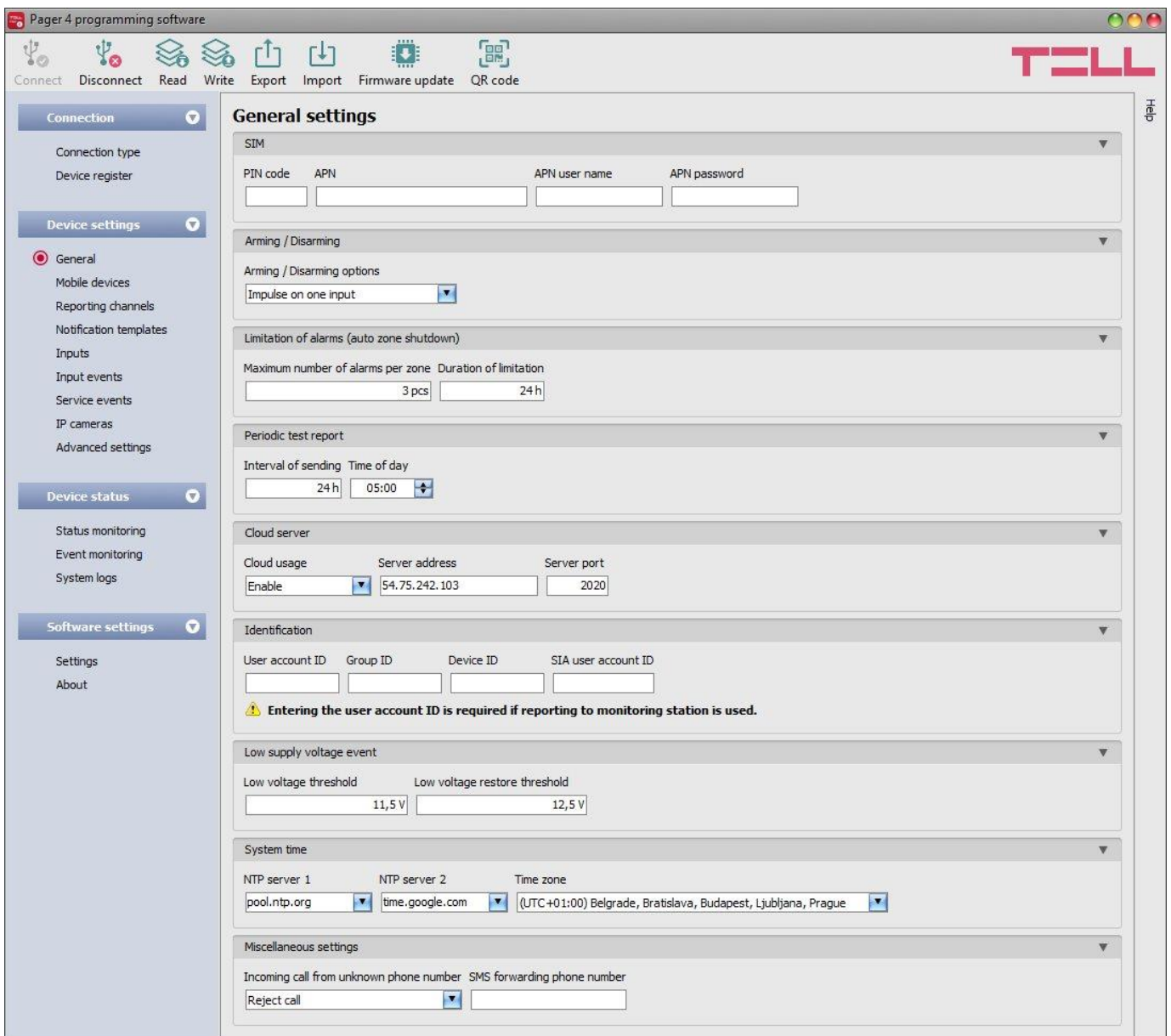

In this section you can configure the parameters related to general operation of the device.

Available options:

- Read the settings from the device:



To read the settings from the device click on the “**Read**” button. This will read all settings in all menus.

- Write the settings into the device:



After changing the settings or entering new settings, in order to take effect, it is necessary to write the new settings into the device by clicking on the “**Write**” button. This will write the changes only, but all changes made in any menu.

- Save settings to file:



To save all device settings to file click on the “**Export**” button.

- Load settings from file:



To load saved settings from file click on the “**Import**” button.

- Firmware update:



By clicking on the “**Firmware update**” button, the firmware of the device can be updated. Clicking on the button, opens a pop-up window, where you can browse the firmware file with **tf3** extension. When firmware upload is finished, the progress window closes automatically and 5 seconds later the device restarts with the new firmware.

**Please note that the settings have to be written in the device in order to be applied after a change is made. For this, click on the “**Write**”  button.**

### **SIM:**

**PIN code:** if you wish to use PIN code management, enter in this section the PIN code of the SIM card installed into the device. Otherwise disable PIN code request on the SIM card. If the wrong PIN code has been entered, the device will try the code only once each time the code is changed in the settings and PIN code error message will be shown in the system logs. If the wrong code is configured 3 times consecutively, the SIM card will reach the PUK code request stage. In this case install the SIM card into a cellphone, unlock the card by entering the PUK code when requested, and configure the valid PIN code in the device settings.

**APN:** the APN name necessary to connect to the Internet. (ask this from the GSM service provider of the SIM card installed into the device). If no APN is configured, the device will not try to connect to the Internet. In this case you can only use the functions which do not require Internet connection, such as voice calls and SMS sending.

**APN user name:** necessary only if the GSM service provider provides this and requires its usage for the given APN.

**APN password:** necessary only if the GSM service provider provides this and requires its usage for the given APN.

## Arming / Disarming:

**Arming / Disarming options:** the device can also be used as a standalone alarm control device and can be armed/disarmed using dry contacts on inputs or remotely by phone call or SMS, or by using the arming/disarming controls in the programming software. For arming/disarming by dry contacts you can use any accessory which has dry contact outputs, e.g. access control keypad, card reader, RF remote controller, key switch or a simple switch, pushbutton, etc. In order to make it possible to use the device according to the demands, different arming/disarming options are available:

- **Always armed:** choose this control mode if you do not wish to arm and disarm the device, but the inputs should always be armed, events should be generated and notifications should be sent when activated. In this case arming and disarming will not be available and all inputs will act as 24h zones.
- **Bistable contact:** choose this control mode if you wish to arm and disarm the device using a toggle switch or relay output (open or closed). This control mode uses input IN4 (for the IN4.R2 model) or input IN6 (for the IN6.R1 model), which in this case can be used for arming/disarming only. When input IN4/IN6 is active, the device will be armed, and when inactive, the device will be disarmed. Assigning the open/closed state of the dry contact to the active/inactive state of the input can be done by configuring the input type (normally open or normally closed) for the given input (IN4/IN6).  
For normally open (NO): open=inactive=device disarmed, closed=active=device armed.  
For normally closed (NC): open=active=device armed, closed=inactive=device disarmed.  
Since the state of the dry contact defines the armed/disarmed status, therefore remote arming and disarming is not available for this control mode.
- **Impulse on one input:** choose this control mode if you wish to arm and disarm the device by dry contact impulses (e.g. pushbutton, or monostable relay output) using up one input. This control mode uses input IN4 (for the IN4.R2 model) or input IN6 (for the IN6.R1 model), which in this case can be used for arming/disarming only. The device will become armed when input IN4/IN6 is activated shortly (impulse), then it will become disarmed upon next short activation of the same input. Assigning the open/closed state of the dry contact to the active/inactive state of the input can be done by configuring the input type (normally open or normally closed) for the given input (IN4/IN6).  
For normally open (NO): open=inactive, closed=active.  
For normally closed (NC): open=active, closed=inactive.  
Remote arming and disarming is also available for this control mode.
- **Impulse on two inputs:** choose this control mode if you wish to arm and disarm the device by dry contact impulses (e.g. pushbuttons, or monostable relay outputs) using up two inputs. This control mode uses inputs IN3 and IN4 (for the IN4.R2 model) or inputs IN5 and IN6 (for the IN6.R1 model), which in this case can be used for arming/disarming only. The device will become armed when input IN3/IN5 is activated shortly (impulse), then it will become disarmed when input IN4/IN6 is activated shortly. Assigning the open/closed state of the dry contact to the active/inactive state of the inputs can be done by configuring the input type (normally open or normally closed) for the given inputs (IN3/IN5 and IN4/IN6).  
For normally open (NO): open=inactive, closed=active.  
For normally closed (NC): open=active, closed=inactive.  
Remote arming and disarming is also available for this control mode.
- **Remote arming/disarming only:** choose this control mode if you wish to use all inputs for custom notifications, In this case the device cannot be armed and disarmed locally through the inputs. Arming and disarming can only be done remotely by phone call, SMS, or by using the arming/disarming controls in the programming software.

## Limitation of alarms (auto zone shutdown):

**Maximum number of alarms per zone** (1 to 100pcs): in this section you can configure the maximum number of alarms (activation events) to be accepted from one input. This makes it possible to avoid a faulty detector connected to an input to generate alarms and notifications continuously. If the number of alarm events generated by an input reaches the value configured here, the given input will become restricted and the device will ignore further activation events of the given input.

If the arming/disarming settings are not configured to “**Always armed**”, disarming and rearming the device will re-enable the restricted input, then alarm events will be accepted again from the given input, but again only the number of alarm events configured. If the arming/disarming settings are configured to “**Always armed**”, or the “**24h zone**” option is enabled for the given input, the restricted input will be re-enabled automatically when the time configured at the “**Duration of limitation**” option expires. The restriction only applies to inputs for which the “**Auto shutdown**” option is enabled.

**Duration of limitation** (1 to 24h): in this section you can configure how long the device should ignore an input which has reached the limitation value entered at “**Maximum number of alarms per zone**” option. When this period of time expires, the alarm counter will be reset automatically and the input will be enabled again. This setting only applies to inputs for which both the “**Auto shutdown**” and “**24h zone**” option is enabled, or to any input for which the “**Auto shutdown**” option is enabled, if the arming/disarming settings are configured to „**Always armed**”.

## Periodic test report:

- **Interval of sending** (1 to 168h): the interval of periodic test report sending.
- **Time of day** (hh:mm): the time of day for periodic test report sending.

## Cloud server:

**Cloud usage:** if this option is enabled, the device will connect to the cloud server operated by the manufacturer and will stay connected continuously. Using the cloud server, special services become available, such as remote programming, control and monitoring of your device. If enabled, the device will always be online and thereby accessible at anytime. If disabled, the device will connect to the cloud server only upon request sent by SMS to the phone number of the device. You can read more about this in the “[Remote connecting to devices via cloud service](#)” paragraph.

**Server address:** the IP address of the cloud server (default: **54.75.242.103**)

**Server port:** the port number of the cloud server (default: **2020**)

## Identification:

**User account ID:** the user account ID necessary for Contact ID reporting to CMS. The events and, if using the TELLMon or TEX protocol, the supervision messages are also sent using the user account ID configured in this section. The user account ID length is 4 hexadecimal characters and the following characters can be used: 0..9, A, B, C, D, E, F.

**Group ID:** the CMS identifier in hexadecimal format. This is only required if the TEX protocol is used for reporting to CMS. If you do not possess this identifier, please contact your reseller.

**Device ID:** the device identifier in hexadecimal format. This is only required if the TEX protocol is used for reporting to CMS. The length is 3 characters and the following characters can be used: 0...9, A, B, C, D, E, F.

**SIA user account ID:** in case of using the SIA IP protocol, the supervision messages are sent to CMS using the user account ID configured in this section. The length of the SIA user account ID is 1 to 6 hexadecimal characters, and the following characters can be used: 0..9, A, B, C, D, E, F. Do not fill in the account ID section with zeros!

**Note!** The user account ID, group ID, device ID and SIA user account ID are only needed if reporting to CMS is used.

#### **Low supply voltage event:**

**Low voltage threshold:** the device has built-in supply voltage monitoring function. In this section you can configure the threshold from 10 to 30V, at which the device will generate the “**Low supply voltage**” event. The event will be generated if the supply voltage is continuously at, or below the configured level for at least 30 seconds.

**Low voltage restore threshold:** In this section you can configure the threshold from 10 to 30V, at which the device will generate the “**Low supply voltage**” restore event. The event will be generated if the supply voltage is continuously at, or above the set level for at least 30 seconds after a “**Low supply voltage**” event.

#### **System time:**

**NTP server 1,2:** in this section you can select one of the default NTP servers or you can also configure custom NTP servers which you wish to use for system time synchronization. The device synchronizes the system time from the GSM network and if this fails, it will use the NTP servers. If synchronization from the NTP servers also fails, it will synchronize the date and time using the timestamp received from a CMS server/receiver, if CMS is used.

**Time zone:** select the time zone according to the location of installation. The device adjusts the system time according to the time zone setting. If the setting is wrong, there will be difference between the system time and the local time and therefore the timestamps of the events will also be wrong and the periodic test report will also be sent at the wrong time of day.

#### **Miscellaneous settings:**

**Incoming call from unknown phone number:** in this section you can configure what the device should do upon a phone call received from a phone number which is not configured in the device as a user phone number, or a call received with hidden caller ID. You can configure the device to accept or reject these calls. Independently of the selected option, receiving a call from an unknown phone number also generates a service event, which you can configure separately to control the output(s) or send notifications.

**SMS forwarding phone number:** the device forwards the messages received by its SIM card to the phone number configured in this section (e.g. balance information received from the GSM service provider in case of pre-pay card). The received messages are deleted automatically after forwarding. If no phone number is configured, the device deletes all incoming messages without forwarding.

## 5.2.2 Mobile devices (Pager4 PRO only)

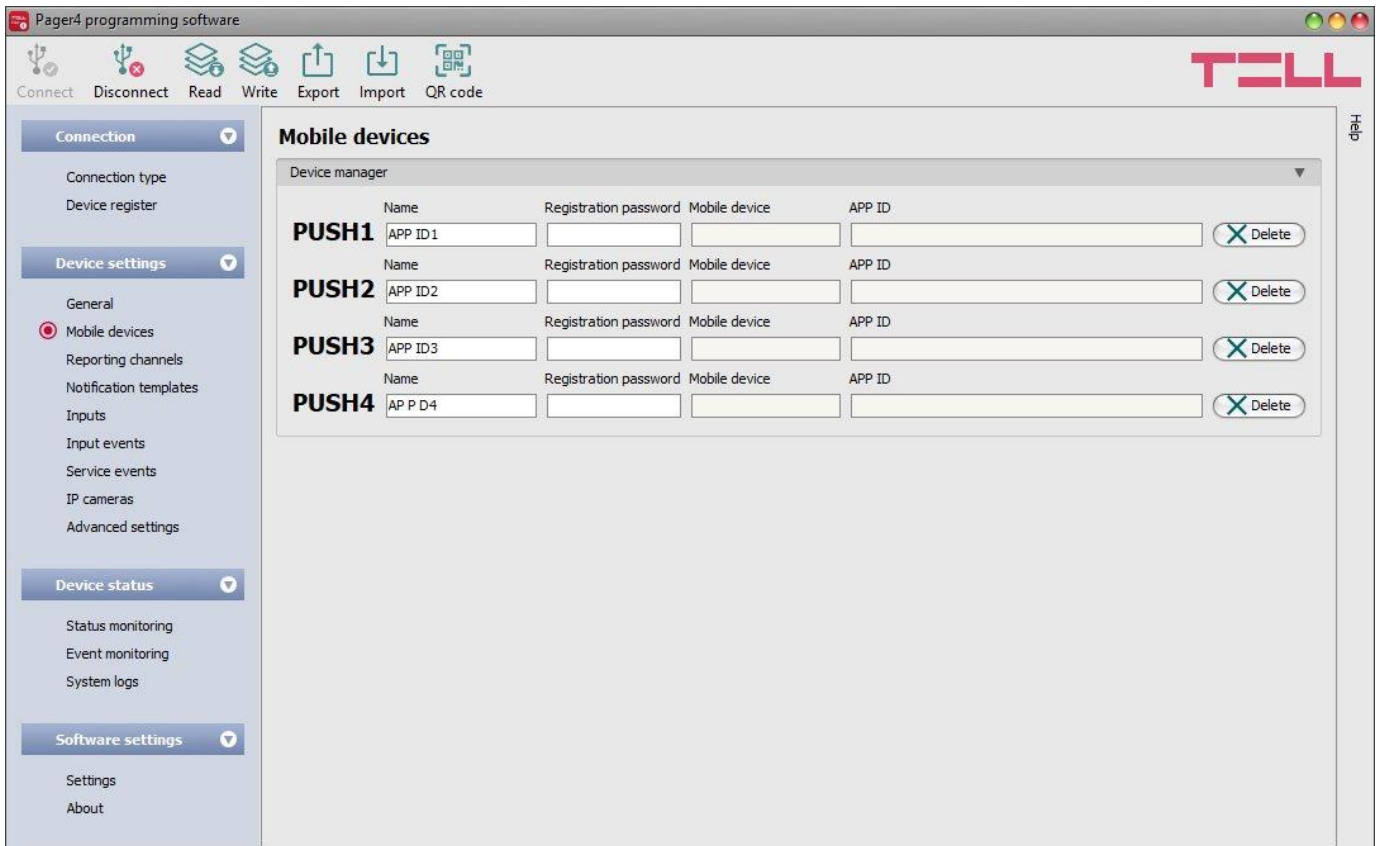

In this menu you can manage the access of mobile applications. The device supports access of up to 4 mobile devices, for which you can configure here the registration password requested upon assigning the mobile application to the device, and it is also possible to delete a mobile device if needed, i.e. to cancel its assignment/registration. The mobile application can be assigned to the device with the help of a QR code, which you can generate by clicking on the “**QR code**” button.

Available options:

- Read the settings from the device:



To read the settings from the device click on the “**Read**” button. This will read all settings in all menus.

- Write the settings into the device:



After changing the settings or entering new settings, in order to take effect, it is necessary to write the new settings into the device by clicking on the “**Write**” button. This will write the changes only, but all changes made in any menu.

- Save settings to file:



To save all device settings to file click on the “**Export**” button.

- Load settings from file:



To load saved settings from file click on the “**Import**” button.



- QR code:



The “**QR code**” button can be used to generate the QR code necessary for assigning the mobile application to the device. The QR code includes connection data: device ID, server IP address and port number, and the sequence number of the mobile device / user (1 to 4).



A different QR code belongs to each mobile device (1 to 4). You can select the desired mobile device using the “**Mobile device**” drop-down menu. The QR code selected this way can be copied to clipboard, saved to file or printed by clicking on the appropriate buttons.

**Please note that the settings have to be written in the device in order to be applied after a change is made. For this, click on the “*Write*”  button.**

### Device manager:

In case of assigning a mobile application to the **Pager4** device, receiving alerts from the device will become available through Push notification too. For this, when configuring events, you can select which of the maximum 4 (**PUSH1...PUSH4**) assigned mobile devices you wish to receive a Push notification on when the given event occurs.

**Name:** the name of mobile device’s user. The name entered in this section will be used to identify the mobile devices upon selecting the notification channels when configuring events.

**Registration password:** the registration password has to be provided in the mobile application when you wish to assign it to the device. This password can be configured in this section separately for each mobile device to be assigned. The registration password length is 4 to 8 characters and only letters and numbers are accepted. Accented letters are not accepted.

**Mobile device:** this field shows the name of the given device already assigned, which is read by the mobile application from the mobile device, therefore this name cannot be changed in the programming software.

**APP ID:** this field shows the identifier of the given assigned mobile device. This identifier is used to identify the mobile device and it is unique for each device.

**Delete:** the “**Delete**” button is used to delete the given mobile device, i.e. to cancel its assignment/registration. In case of deleting a mobile device, the application used on the given device will no longer have access to the **Pager4** device.

## 5.2.3 Reporting channels

The screenshot shows the 'Reporting channels' configuration window in the Pager 4 programming software. The window title is 'Pager 4 programming software'. The top toolbar contains icons for 'Connect', 'Disconnect', 'Read', 'Write', 'Export', and 'Import'. The left sidebar has a tree view with categories: 'Connection' (Connection type, Device register), 'Device settings' (General, Mobile devices, Reporting channels, Notification templates, Inputs, Input events, Service events, IP cameras, Advanced settings), 'Device status' (Status monitoring, Event monitoring, System logs), and 'Software settings' (Settings, About). The main area is titled 'Reporting channels' and contains three main sections:

- CID reporting to CMS over IP:** This section contains four entries labeled IP1, IP2, IP3, and IP4. Each entry has fields for Name, IP address / domain name, Port, Protocol, Supervision message, Supervision message interval, Unit of measure, and Time zone. IP1 and IP2 have ports 3333 and protocols TEX. IP3 has port 3535 and protocol TELLMON. IP4 has port 9999 and protocol SIA IP. IP3 also has a 'Network protocol' dropdown set to TCP. IP4 has a 'Network protocol' dropdown set to UDP and an 'AES key' field.
- CID reporting to CMS over DTMF-based voice call:** This section contains two entries labeled TEL1 (DTMF) and TEL2 (DTMF). Each entry has fields for Name and Phone number.
- User phone number settings:** This section contains three entries labeled TEL1, TEL2, and TEL3. Each entry has fields for Name, Phone number, Event acknowledgement options, and Incoming call management.

In this section you can configure all availabilities where reports and notifications should be sent, such as CMS servers and receivers, user phone numbers for calls and SMS sending, and e-mail addresses for notification by e-mail in case of using the **Pager4 PRO** model.

Available options:

- Read the settings from the device:



To read the settings from the device click on the “**Read**” button. This will read all settings in all menus.

- Write the settings into the device:



After changing the settings or entering new settings, in order to take effect, it is necessary to write the new settings into the device by clicking on the “**Write**” button. This will write the changes only, but all changes made in any menu.

- Save settings to file:



To save all device settings to file click on the “**Export**” button.

- Load settings from file:



To load saved settings from file click on the “**Import**” button.

**Please note that the settings have to be written in the device in order to be applied after a change is made. For this, click on the “**Write**”**  **button.**

### CID reporting to CMS over IP:

You can configure up to 4 IP availabilities of CMS servers or receivers as follows.

**Name:** CMS server or receiver name. The name entered in this section is used for identification of the server/receiver within the program, and the program will also use this name when configuring notification templates.

**IP address/domain name:** CMS server or receiver IP address or domain name.

**Port:** CMS server or receiver communication port number.

**Protocol:** select the appropriate communication protocol for the given server or receiver from the drop-down menu. Available protocols: **TELLMon**, **TEX**, **SIA IP** (ANSI/SIA DC-09-2007).

**Supervision message:** enable/disable supervision message sending. Supervision message sending cannot be disabled in case of using the TEX or the TELLMon communication protocol.

**Supervision message interval / Unit of measure:** if supervision message sending is enabled, you can configure the sending interval and unit of measure. The supervision message sending interval can be configured from 10 seconds to 30 minutes.

**Network protocol:** according to the chosen communication protocol you can use **TCP** or **UDP** network protocol. The UDP protocol allows for less data traffic. For TEX communication protocol only TCP network protocol is available.

**AES key:** the custom AES encryption key can be used for SIA IP protocol only. If an encryption key is configured, the SIA IP packages will be encrypted with the given key and they have to be decrypted on the receiver side using the same key. The maximum length of the AES key is up to 16 characters, or up to 32 characters in case of using hexadecimal format.

### CID reporting to CMS over DTMF-based voice call:

Please note that in certain cases you may experience issues with reporting to CMS over DTMF-based voice call. Success of communication highly depends on the properties of the given GSM network, such as line quality, line noise and DTMF handling. Due to network digitalization, DTMF signal tones might get distorted while being processed by the network in such extent that the receiver will not be able to interpret the transmitted Contact ID event codes. The risk of this is even higher if the signal is transmitted through multiple GSM operators (e.g. if using SIM cards from different operators on the transmission and reception site). The device offers an option to adjust the signals in order to correct such problems, therefore if necessary, special DTMF communication parameters can be configured in the “**Advanced settings**” menu.

You can configure up to 2 DTMF receiver phone numbers (**TEL1 DTMF** and **TEL2 DTMF**) as follows.

**Name:** CMS DTMF receiver name. The name entered in this section is used for identification of the receiver within the program, and the program will also use this name when configuring notification templates.

**Phone number:** the phone number of the DTMF receiver.

### User phone number settings:

You can configure up to 10 user phone numbers (**TEL1** to **TEL10**) for voice calls, SMS sending and remote control by SMS and calls.

**Name:** user name. The name entered in this section will be used upon selecting the notification channels when configuring events.

**Phone number:** user phone number.

**Event acknowledgement options:** when the device sends a notification by call, it requires a confirmation that the notification has been received, otherwise it will retry to deliver the notification. In this section you can configure the actions required from each user upon receiving a notification by voice call. Available options:

- **Accept call to acknowledge:** notifications will be acknowledged automatically upon accepting the calls. After accepting the call, wait at least 3 seconds before ending the call.
- **Reject or accept call to acknowledge:** notifications will be acknowledged automatically if the calls are rejected by user, and also if the calls are accepted.
- **Press \* to acknowledge:** notifications have to be acknowledged by pressing the star (\*) key on the phone after accepting the call. The device will confirm that it has received the command by a short signal tone.
- **Press \* to acknowledge or # to stop notification:** notifications have to be acknowledged by pressing the star (\*) key on the phone after accepting the call. The device will confirm that it has received the command by a short signal tone. Notification of further users on the given event can be stopped by pressing the hash (#) key on the phone. The device will confirm that it has received this command by three short signal tones. By pressing the hash (#) key, this also confirms reception of the notification at the same time, so it is not necessary to press the star (\*) key too.  
By this option it is also possible to cancel all pending notifications for all events by entering the **\*device password#** command (e.g. **\*1234#**) using the phone's keys. The superadmin and admin passwords are both accepted.

**Incoming call management:** in this section you can configure for each user what should the device do when it receives a call from the given user. Independently of the selected option, receiving a call from a user phone number also generates a service event, which you can configure separately to control the output(s) or send notifications. Available options:

- **Accept call and request password:** the device accepts the call which it confirms by a short signal tone and then the password should be entered in order to accept commands. The superadmin and admin passwords are both accepted. The user needs to enter the valid password using the phone's keys as follows: **\*9device password#** (e.g. **\*91234#**). If the valid password has been entered, the device confirms this by three short signal tones, otherwise a long signal tone will be emitted. If the command is wrong (missing \* or #), no signal tone will be emitted. After the password has been accepted, the caller can use commands as specified in the list of DTMF commands. The device will also identify the user's phone number by CLIP service, which makes it possible to perform further actions automatically upon receiving the call. For this, an "**incoming call from user**" event should be configured for the given phone number at the service events.
- **Accept call and don't request password:** the device accepts the call which it confirms by a short signal tone and then commands can be used as specified in the list of DTMF commands, without the need of entering the password. The device will also identify the user's phone number by CLIP service, which makes it possible to perform further actions automatically upon receiving the call. For this, an "**incoming call from user**" event should be configured for the given phone number at the service events.
- **Reject call:** the device will reject calls received from the given user phone number, but will identify the phone number by CLIP service for further actions, which are available by configuring an "**incoming call from user**" event for the given phone number at the service events. By rejecting the calls, the configured actions can be performed free of charge (except if the given GSM service provider applies a charge for rejected calls as well).

### E-mail notification recipients (Pager4 PRO only):

You can configure up to 4 e-mail addresses (**MAIL1** to **MAIL4**) to which the device will send notification upon event occurrence, according to the event settings.

**Name:** user/recipient name. The name entered in this section will be used upon selecting the notification channels when configuring events.

**E-mail address:** user/recipient e-mail address. You can configure 1 e-mail address per user.

## 5.2.4 Notification templates

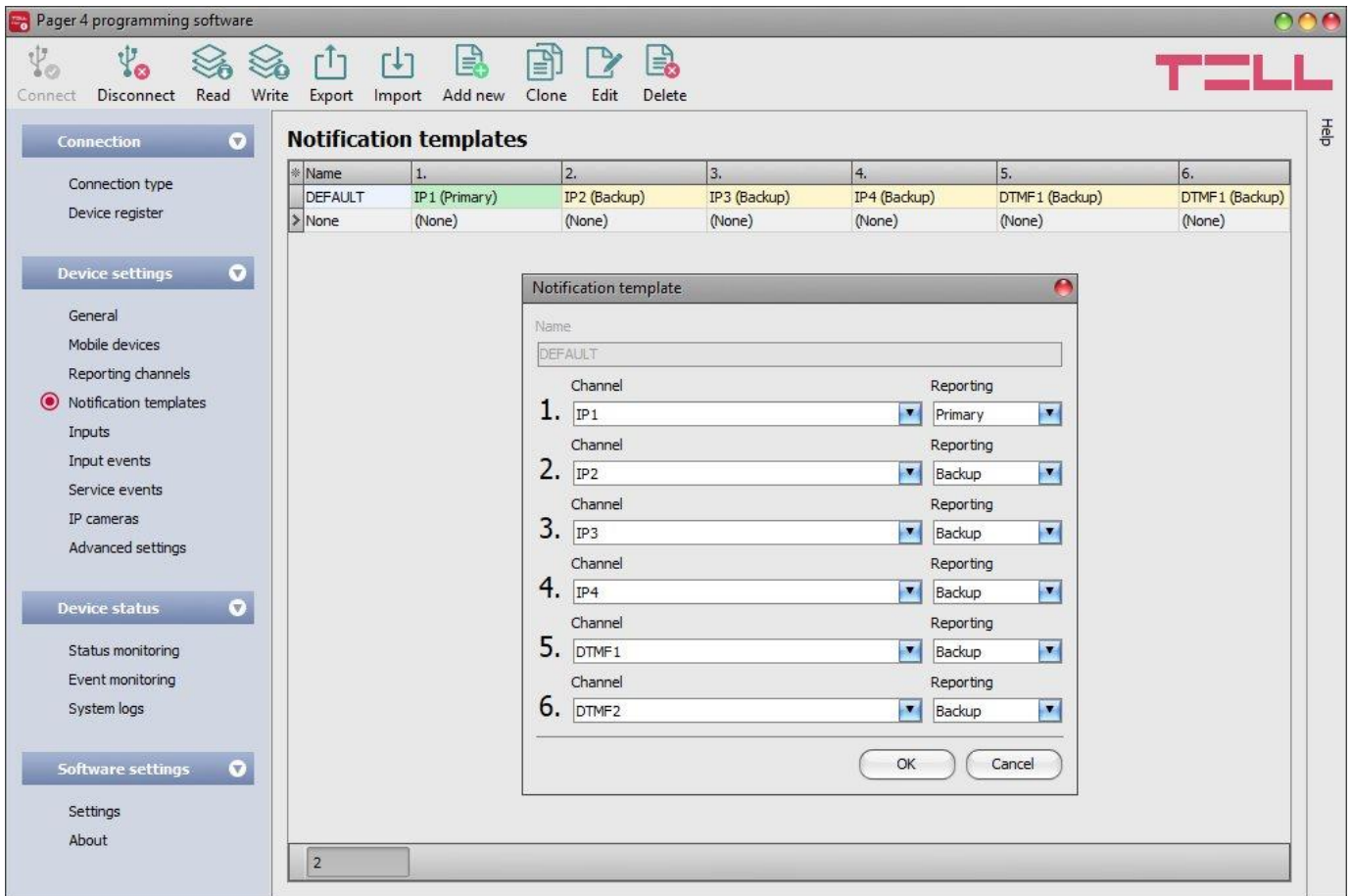

Notification templates should only be configured if reporting to CMS is needed. In this menu you can configure different templates according to which the device will send reports to CMS servers and receivers. For quick and easy setup, the device contains 2 built-in templates, named as **“EMPTY”** and **“DEFAULT”**, which cannot be deleted, but their configuration can be changed if needed. If you wish to add new notification templates, this should be done prior to configuring events. Any template can be assigned to any event, thus reports can be directed to the desired servers and receivers using the desired priorities. Servers/receivers are classified into two groups, primary and backup. When an event occurs, the given report will be sent to all servers and receivers configured as primary in the notification template assigned to the given event. In case that none of the primary servers/receivers are available, the device will try to report to the servers/receivers configured as backup.

The order and priority of reporting to servers and receivers configured in a template corresponds to the numbering (1 to 6) of the channels in the template. The priority also depends on the classification of the configured servers/receivers (primary or backup). Primary servers/receivers will be notified first, according to the channel numbering. Reports will be sent to all primary servers/receivers, while backup servers/receivers will only be notified if reporting to all primary ones fail. In this case the device tries to report to the first highest priority backup server/receiver, then if this fails, to the second and so on. If a primary channel fails, it will automatically become a backup channel for that specific event, which means that the device will try to report again to the given server/receiver with the number of attempts assigned to its channel number. The number of attempts according to channel numbering is the following:

Channel No. 1: 10 attempts  
Channel No. 2: 9 attempts  
Channel No. 3: 8 attempts  
Channel No. 4: 7 attempts  
Channel No. 5: 6 attempts  
Channel No. 6: 5 attempts

This applies to primary and backup channels as well, e.g. the number of attempts in case of a primary server/receiver with channel position No. 2 will be 9 (and further 9 as backup if reporting fails, since in this case the given primary channel will automatically become a backup channel for that specific event). Additionally, if a reporting channel fails, the devices will keep sending supervision signals to the given server/receiver by the configured supervision sending interval to check its availability and will send the report as soon as it becomes available. The device will no longer try to report events for which reporting failed for more than 24 hours.

Notification templates cannot be deleted while they are assigned to an event. The system allows for adding at most 10 notification templates, including the built-in ones.

Available options:

- Read the settings from the device:



To read the settings from the device click on the “**Read**” button. This will read all settings in all menus.

- Write the settings into the device:



After changing the settings or entering new settings, in order to take effect, it is necessary to write the new settings into the device by clicking on the “**Write**” button. This will write the changes only, but all changes made in any menu.

- Save settings to file:



To save all device settings to file click on the “**Export**” button.

- Load settings from file:



To load saved settings from file click on the “**Import**” button.

- Add new notification template:



To add a new notification template click on the “**New**” button.

- Create a copy of an existing template:



To create a copy of the selected template click on the “**Clone**” button. Please note that the new copy should have a different unique name.

- Edit an existing template:



To edit the selected template click on the “**Edit**” button.



- Delete a template:



To delete the selected template click on the “**Delete**” button.

**Please note that the settings have to be written in the device in order to be applied after a change is made. For this, click on the “*Write*”  button.**

Creating a new notification template:

- Click on the “**New**”  button.
- Enter a name for the new template. The name should not be longer than 20 characters, and the following characters should not be used: ~ ^ < > = | \$ &.
- Configure the channels and the reporting priority.
- Click on the “**OK**” button.
- Click on the “**Write**”  button.

## 5.2.5 Inputs

The screenshot shows the 'Inputs' configuration window in the Pager 4 programming software. The main window has a table of inputs and a detailed 'Input' dialog box.





* Identif	Input type	Sensitivity	Unit of measure	Restore sensitivity	Unit of measure	Entry delay	Exit delay	24h zone	Auto shutdown	Force	Follow
IN1	NC	100 ms		100 ms		15 s	30 s	<input type="checkbox"/>	<input checked="" type="checkbox"/>	<input checked="" type="checkbox"/>	<input type="checkbox"/>
IN2	NC	100 ms		100 ms		0 s	0 s	<input type="checkbox"/>	<input checked="" type="checkbox"/>	<input checked="" type="checkbox"/>	<input checked="" type="checkbox"/>
IN3	NC	100 ms		100 ms		0 s	0 s	<input type="checkbox"/>	<input checked="" type="checkbox"/>	<input checked="" type="checkbox"/>	<input checked="" type="checkbox"/>
IN4	NC	100 ms		100 ms		0 s	0 s	<input type="checkbox"/>	<input checked="" type="checkbox"/>	<input checked="" type="checkbox"/>	<input type="checkbox"/>
IN5	NC	100 ms		100 ms		0 s	0 s	<input type="checkbox"/>	<input checked="" type="checkbox"/>	<input checked="" type="checkbox"/>	<input type="checkbox"/>
IN6	NC	100 ms		100 ms		0 s	0 s	<input checked="" type="checkbox"/>	<input checked="" type="checkbox"/>	<input type="checkbox"/>	<input type="checkbox"/>

The 'Input' dialog box shows the following settings for IN1:

- Input properties:** Identifier: IN1, Input type: NC, Sensitivity: 100, Unit of measure: ms, Restore sensitivity: 100, Unit of measure: ms.
- Delay settings:** Entry delay: 15 sec, Exit delay: 30 sec.
- Zone options:**
  - 24h zone (always armed)
  - Auto shutdown (will be ignored after reaching the configured limit of alarms)
  - Force (allow arming when the input is activated)
  - Follow (takes over the properties of the first violated zone)

In this menu you can configure the properties and options of the dry contact inputs.

Available options:

- Read the settings from the device:  
 To read the settings from the device click on the “**Read**” button. This will read all settings in all menus.
- Write the settings into the device:  
 After changing the settings or entering new settings, in order to take effect, it is necessary to write the new settings into the device by clicking on the “**Write**” button. This will write the changes only, but all changes made in any menu.
- Save settings to file:  
 To save all device settings to file click on the “**Export**” button.
- Load settings from file:  
 To load saved settings from file click on the “**Import**” button.
- Edit input settings:  
 To edit the settings of the selected input click on the “**Edit**” button.

Please note that the settings have to be written in the device in order to be applied after a change is made. For this, click on the “**Write**”  button.



### Input properties:

**Identifier:** the identifiers of the inputs cannot be changed. They are used for identification of the inputs in the program.

**Input type:** the input can be normally open (**NO**), or normally closed (**NC**). When set to **NO**, event is generated when the input circuit is closed, while when set to **NC**, opening the input circuit generates an event. The input is closed when the given input **IN1...IN4/IN6** is shorted to „V-“ terminal (DC power negative).

**Sensitivity / unit of measure:** state changes of the input shorter than the value entered in this section with regard to activation of the input are ignored by the device. The unit of measure can also be selected (milliseconds, seconds or minutes).

**Restore sensitivity / unit of measure:** state changes of the input shorter than the value entered in this section with regard to restoration of the input are ignored by the device. The unit of measure can also be selected (milliseconds, seconds or minutes).

### Delay settings:

**Entry delay:** in this section you can configure the time available to disarm the device after violating the given zone. The device ignores state changes of the given input for the time of the entry delay, so input event will not be generated until the time expires. If the time expires and the system is still armed, an input event will be generated. The entry delay can be configured in seconds.

**Exit delay:** in this section you can configure the time for which state changes of the given input will be ignored after arming the device. If the given zone is violated during the exit delay, input event will not be generated. The exit delay can be configured in seconds.

### Zone options:

**24h zone:** if this option is enabled, the given input becomes armed continuously and does not disarm when the device is disarmed. State changes of the given input will generate input events even if the device is disarmed.

**Auto shutdown:** if this option is enabled, generating events by the given input will be limited according to the “*Limitation of alarms*” settings in the “*General*” settings menu. The device will ignore state changes of the given input after the number of events generated by it reaches the configured limit. For further details please read the specification of the mentioned settings. If disabled, the given input can generate unlimited number of events.

**Force:** if this option is enabled the device will ignore the state of the given input upon arming. If the given input is activated upon arming the device, it will become armed after it restores. If this option is disabled, arming will be forbidden if the given input is activated.

**Follow:** if this option is enabled, the given input will take over the properties (entry delay, instant) of the first violated zone (input) after arming. If entry delay is configured for the first violated zone, the follow zone will use the same entry delay, or if the first violated zone is instant (no entry delay is configured for the given zone), the follow zone will be instant too.

Click “**OK**” to accept the changes or “**Cancel**” to quit without saving.

## 5.2.6 Input events

The screenshot shows the 'Input events' configuration window in the TELL programming software. The window is titled 'Input events' and contains a table of input events and a detailed configuration panel for a selected event (IN3).

Name	Input	Type	Event code	Partition	Zone	Notification template	Output control mode	Message	Voice message	TEL1 (SMS)	TEL2 (SMS)	TEL1 (Call)	TEL2 (Call)
IN1	IN1	New event	130	01	001	DEFAULT	(None)	Alarm 1	1	<input type="checkbox"/>	<input type="checkbox"/>	<input checked="" type="checkbox"/>	<input checked="" type="checkbox"/>
IN1 restore	IN1	Restore	130	01	001	DEFAULT	(None)		1	<input type="checkbox"/>	<input type="checkbox"/>	<input type="checkbox"/>	<input type="checkbox"/>
IN2	IN2	New event	130	01	002	DEFAULT	(None)	Alarm 2	2	<input type="checkbox"/>	<input checked="" type="checkbox"/>	<input checked="" type="checkbox"/>	<input type="checkbox"/>





The configuration panel for event IN3 shows the following settings:

- Event:** Name: IN3, Input: IN3, Type: New event
- Remote monitoring:** Event code: 130, Partition: 01, Zone: 003, Notification template: DEFAULT
- Output:** Output control mode: Monostable, Output parameter settings: mono, 180000
- Voice call notification:** Voice call: TEL1, Voice message: 2
- Text-based notifications:**
  - SMS notification: TEL2
  - Push notification: PUSH3, PUSH4
  - E-mail notification: EMAIL3, EMAIL4
  - Message: Alarm 3
  - Camera: CAM1

A warning message states: "In order to send Push notifications it is necessary to assign the smartphone application to the device."

In this menu you can configure the input events generated by the contact inputs. Input events should be added and configured for the inputs you wish to use. If no input event is configured for an input, the given input will not generate any events or notifications. For each input you can add one new and one restore event.

Available options:

- Read the settings from the device:  To read the settings from the device click on the “**Read**” button. This will read all settings in all menus.
- Write the settings into the device:  After changing the settings or entering new settings, in order to take effect, it is necessary to write the new settings into the device by clicking on the “**Write**” button. This will write the changes only, but all changes made in any menu.
- Save settings to file:  To save all device settings to file click on the “**Export**” button.
- Load settings from file:  To load saved settings from file click on the “**Import**” button.

- Add new input event:



To add a new input event click on the “**New**” button.

- Create a copy of an existing input event:



To create a copy of the selected input event click on the “**Clone**” button. Please note that the new copy should have a different unique name.

- Edit input event settings:



To edit the settings of the selected input event click on the “**Edit**” button.

- Delete an input event:



To delete the selected input event click on the “**Delete**” button.

**Please note that the settings have to be written in the device in order to be applied after a change is made. For this, click on the “**Write**”  button.**

### Event:

**Name:** custom name of the event. The name entered in this section is used for identification of the given event within the program and in the event logs.

**Input:** the contact input which will generate the given event.

**Type:** the type of the event which can be new or restore. New event will be generated when an input is activated and restore event will be generated it reverts to its normal state. In the Contact ID protocol new event is indicated with 1 (or E), while restore is indicated with 3 (or R).

### Remote monitoring:

In this section you can configure the Contact ID event code for reporting to CMS and can select one of the preconfigured notification templates for the given event. The Contact ID event code should only be configured if reporting to CMS is used, otherwise select the notification template named “**EMPTY**”.

**Event code:** in this section you can configure the 3-digit Contact ID event code, consisting of characters 0..9,A,B,C,D,E,F, which you wish to assign to the given event. The default configuration for input event codes is 130, which means burglar alarm.

**Partition:** in this section you can configure the partition number you wish to assign to the given event. The default configuration for partition is 01.

**Zone:** in this section you can configure the zone number you wish to assign to the given event. The default configuration for zones is in accordance with the number of the inputs (001 to 006).

**Notification template:** in this section you can select a preconfigured notification template which you wish to use for the given event. If you wish to use additional notification templates, these should be added prior to configuring the events. If you do not wish to send a report to CMS on the given event, select the template named “**EMPTY**”.

## Output:

In this section you can configure the output(s) to be controlled upon occurrence of a given input event.

**Output control mode:** in this section you can configure the control mode of the output (or the selected output 1 or 2 in case of the IN4.R2 model). Available options:

- **None:** the output will not be used.
- **Monostable:** the output will be activated for the time configured in the “*Duration*” section of the output parameter settings, then it will revert to normal state automatically. The duration can be configured from 5 milliseconds to 60 minutes.
- **Bistable ON:** the output will be activated permanently and will change state only upon receiving a different command or upon power loss.
- **Bistable OFF:** the output will become deactivated.
- **State change:** the output will change state (if deactivated, it will become activated and if activated, it will become deactivated).
- **Pulse series:** the output can be controlled by pulse series as well. The number of pulse series can be configured from 1 up to 3. For each pulse it can be configured how long the output should be activated, how long should be deactivated, the number of repetitions and the pause between repetitions. The active periods can be configured from 5 milliseconds to 60 minutes and the number of repetitions can be configured from 1 to 10.

**Output parameter settings:** this option becomes available if an output control mode is selected which has further settings. In this section you can configure the additional settings of specific output control modes, such as timings for monostable control and pulse series. Click on the “*Edit*” button to open the parameter configuration window.

## Voice call notification:

In this section you can configure phone calls to be made when the given input event occurs. The device will call the selected phone numbers and play the selected voice messages. Voice messages should be recorded in advance as per the instructions in the list of DTMF commands found in the “[Remote control and status query by DTMF commands via phone call](#)” paragraph.

**Voice call:** in this section you can select the user phone numbers to which calls should be made. The phone numbers should be configured in advance in the “*Reporting channels*” menu. Calls will be made to the numbers enabled with the help of the checkboxes in the drop-down list.

**Voice message:** in this section you can select the index number of the voice message which should be played in the calls when the given input event occurs. When receiving a call from the device, a built-in siren tone will be played before each voice message. If an index number has been configured for which no message has been recorded, the siren tone will be played continuously throughout the call.

## Text-based notifications:

In this section you can configure text-based messages to be sent when the given input event occurs.

**SMS notification:** in this section you can select the user phone numbers to which SMS message should be sent when the given event occurs. The phone numbers should be configured in advance in the “**Reporting channels**” menu. The text message will be sent to the numbers enabled with the help of the checkboxes in the drop-down list.

**Push notification** (Pager4 PRO only): in this section you can select the mobile devices to which Push notification should be sent when the given event occurs. The mobile devices should be configured in advance in the “**Mobile devices**” menu. Push notification will be sent to the mobile devices enabled with the help of the checkboxes in the drop-down list.

**E-mail notification** (Pager4 PRO only): in this section you can select the addressees to whom e-mail should be sent when the given event occurs. The e-mail addresses should be configured in advance in the “**Reporting channels**” menu. E-mail will be sent to the addressees enabled with the help of the checkboxes in the drop-down list.

**Message:** in this field you can enter a custom message of maximum 45 characters, which you wish to send to the selected phone numbers, mobile devices or e-mail addresses when the given input event occurs. The device will send the same message for each notification channel (SMS, Push, e-mail).

**Camera** (Pager4 PRO only): in this section you can select the IP camera which you wish to assign to the given event. IP cameras should be configured in advance in the “**IP cameras**” menu. If you have configured an e-mail notification for the given event, the URL of the IP camera assigned to the event will be sent along with the message in the given e-mail.



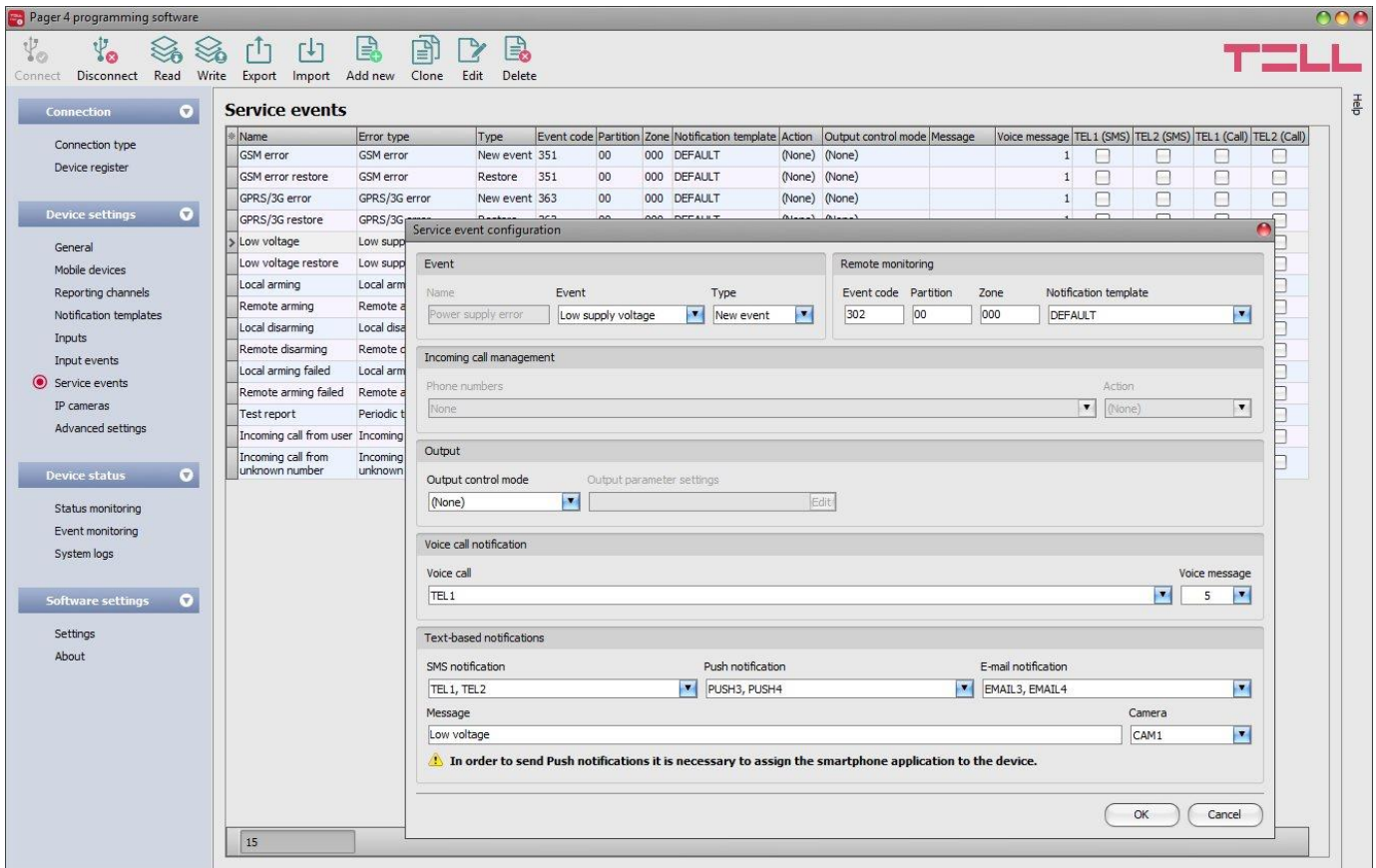

Click “**OK**” to accept the changes or “**Cancel**” to quit without saving.

## 5.2.7 Service events



In this menu you can configure the internal service events generated by the device. Service events you wish to use should be added and configured. If a service event is not added, the given event will not be generated and the device will not send notifications related to that event. For each service event you can add one new and one restore event, except for arming and disarming, periodic test report, incoming call from user and incoming call from unknown phone number events, since the type of these events is fixed.

Available options:

- Read the settings from the device:
  -  To read the settings from the device click on the “**Read**” button. This will read all settings in all menus.
- Write the settings into the device:
  -  After changing the settings or entering new settings, in order to take effect, it is necessary to write the new settings into the device by clicking on the “**Write**” button. This will write the changes only, but all changes made in any menu.
- Save settings to file:
  -  To save all device settings to file click on the “**Export**” button.
- Load settings from file:
  -  To load saved settings from file click on the “**Import**” button.
- Add new service event:
  -  To add a new service event click on the “**New**” button.

- Create a copy of an existing service event:



To create a copy of the selected service event click on the “**Clone**” button. Please note that the new copy should have a different unique name.

- Edit service event settings:



To edit the settings of the selected service event click on the “**Edit**” button.

- Delete a service event:



To delete the selected service event click on the “**Delete**” button.

**Please note that the settings have to be written in the device in order to be applied after a change is made. For this, click on the “**Write**”  button.**

### Event:

**Name:** custom name of the event. The name entered in this section is used for identification of the given event within the program and in the event logs.

**Event:** select an event out of the available service events in the drop-down menu.

Available service events:

- **GSM error:** this type of event is generated if the device loses the connection with the GSM network or it is unable to register on the GSM network for at least 60 seconds. Restore event is generated upon successful registration on the GSM network. Most common reasons for this type of error are the following: there is no SIM card installed into the device or the card is not installed properly, the card is damaged or the service is not available on the SIM card, low GSM signal, the GSM antenna is not connected, insufficient supply voltage/current.
- **GPRS/3G error:** this type of event is generated if the device is unable to establish the Internet connection for at least 60 seconds. Restore event is generated if the Internet connection restores. Most common reasons for this type of error are the following: wrong APN configured or the service is not enabled on the SIM card.
- **Low supply voltage:** the device has built-in supply voltage monitoring function. Low supply voltage event is generated if the supply voltage drops below the configured low supply voltage threshold for at least 30 seconds. Low supply voltage restore event is generated when the supply voltage returns above the configured low supply voltage restore threshold for at least 30 seconds. The threshold values can be configured in the “**General**” settings menu.
- **Local arming:** this type of event is generated upon arming the device locally via the contact inputs.
- **Remote arming:** this type of event is generated upon arming the device remotely by phone call, text message, or by the programming software.
- **Local disarming:** this type of event is generated upon disarming the device locally via the contact inputs.
- **Remote disarming:** this type of event is generated upon disarming the device remotely by phone call, text message, or by the programming software.

- **Local arming failed:** this type of event is generated when local arming fails. This basically occurs when attempting to arm the device locally while an input is activated for which the “*Force*” option is not enabled.
- **Remote arming failed:** this type of event is generated when remote arming fails. This basically occurs when attempting to arm the device remotely while an input is activated for which the “*Force*” option is not enabled.
- **Periodic test report:** this type of event is generated according to the periodic test report settings configured in the “*General*” settings menu.
- **Incoming call from user:** this type of event is generated when the device receives a call from a user phone number configured in the device. The caller ID (phone number) should be presented in the call in order to be identified by the device via CLIP service.
- **Incoming call from unknown number:** this type of event is generated when the device receives a call from a phone number which is not configured in the device as a user phone number, or a call received with hidden caller ID.
- **Output control by APP ID (1...4):** this type of event is generated when the output of the device is controlled from one of the mobile devices (1 to 4) through the mobile application. Activating the output will generate a new event, while deactivating will generate a restore.
- **Entry delay started:** this type of event is generated when a delayed input is activated while the system is armed and entry delay starts.
- **Exit delay started:** this type of event is generated upon arming the system, when exit delay starts.

**Type:** the type of the event which can be new or restore. New event will be generated when a service event occurs, and restore event will be generated when it restores. In the Contact ID protocol new event is indicated with 1 (or E), while restore is indicated with 3 (or R).

### Remote monitoring:

In this section you can configure the Contact ID event code for reporting to CMS and can select the preconfigured notification template for the given event. The Contact ID event code should only be configured if reporting to CMS is used, otherwise select the notification template named “*EMPTY*”.

**Event code:** in this section you can configure the 3-digit Contact ID event code, consisting of characters 0..9,A,B,C,D,E,F, which you wish to assign to the given event. The default event codes are configured according to the standard list of Contact ID event codes.

**Partition:** in this section you can configure the partition number you wish to assign to the given event. The default configuration for partition is 01, except for error events.

**Zone:** in this section you can configure the zone number you wish to assign to the given event.

**Notification template:** in this section you can select a preconfigured notification template which you wish to use for the given event. If you wish to use additional notification templates, these should be added prior to configuring the events. If you do not wish to send a report to CMS on the given event, select the template named “*EMPTY*”.



### Incoming call management:

This option is only available for the “***incoming call from user***” event. In this section you can select user phone numbers for incoming call management and assign an action to them.

**Phone numbers:** in this section you can select the user phone numbers from which incoming calls will generate an “***incoming call from user***” event, and to which you wish to assign an action.

**Action:** in this section you can configure the action to be performed upon receiving a call from the selected user phone numbers. Available options:

- **None:** no action will be performed.
- **Arm only:** the device will change its state to armed.
- **Disarm only:** the device will change its state to disarmed.
- **Arm/Disarm:** the device will change its state call by call from armed to disarmed, respectively from disarmed to armed.

**Note! Remote arming and disarming is only available at specific arming/disarming settings! Please check the arming and disarming options in the “*General*” settings menu.**

### Output:

In this section you can configure the output(s) to be controlled upon occurrence of the given service event.

**Output control mode:** in this section you can configure the control mode of the output (or the selected output 1 or 2 in case of the IN4.R2 model). Available options:

- **None:** the output will not be used.
- **Monostable:** the output will be activated for the time configured in the “***Duration***” section of the output parameter settings, then it will revert to normal state automatically. The duration can be configured from 5 milliseconds to 60 minutes.
- **Bistable ON:** the output will be activated permanently and will change state only upon receiving a different command or upon power loss.
- **Bistable OFF:** the output will become deactivated.
- **State change:** the output will change state (if deactivated, it will become activated and if activated, it will become deactivated).
- **Pulse series:** the output can be controlled by pulse series as well. The number of pulse series can be configured from 1 up to 3. For each pulse it can be configured how long the output should be activated, how long should be deactivated, the number of repetitions and the pause between repetitions. The active periods can be configured from 5 milliseconds to 60 minutes and the number of repetitions can be configured from 1 to 10.

**Output parameter settings:** this option becomes available if an output control mode is selected which has further settings. In this section you can configure the additional settings of specific output control modes, such as timings for monostable control and pulse series. Click on the “***Edit***” button to open the parameter configuration window.

### Voice call notification:

In this section you can configure phone calls to be made when the given service event occurs. The device will call the selected phone numbers and play the selected voice messages. Voice messages should be recorded in advance as per the instructions in the list of DTMF commands found in the [“Remote control and status query by DTMF commands via phone call”](#) paragraph.

**Voice call:** in this section you can select the user phone numbers to which calls should be made. The phone numbers should be configured in advance in the **“Reporting channels”** menu. Calls will be made to the numbers enabled with the help of the checkboxes in the drop-down list.

**Voice message:** in this section you can select the index number of the voice message which should be played in the calls when the given service event occurs. When receiving a call from the device, a built-in siren tone will be played before each voice message. If an index number has been configured for which no message has been recorded, the siren tone will be played continuously throughout the call.

### Text-based notifications:

In this section you can configure text-based messages to be sent when the service input event occurs.

**SMS notification:** in this section you can select the user phone numbers to which SMS message should be sent when the given event occurs. The phone numbers should be configured in advance in the **“Reporting channels”** menu. The text message will be sent to the numbers enabled with the help of the checkboxes in the drop-down list.

**Push notification** (Pager4 PRO only): in this section you can select the mobile devices to which Push notification should be sent when the given event occurs. The mobile devices should be configured in advance in the **“Mobile devices”** menu. Push notification will be sent to the mobile devices enabled with the help of the checkboxes in the drop-down list.

**E-mail notification** (Pager4 PRO only): in this section you can select the addressees to whom e-mail should be sent when the given event occurs. The e-mail addresses should be configured in advance in the **“Reporting channels”** menu. E-mail will be sent to the addressees enabled with the help of the checkboxes in the drop-down list.

**Message:** in this field you can enter a custom message of maximum 45 characters, which you wish to send to the selected phone numbers, mobile devices or e-mail addresses when the given service event occurs. The device will send the same message for each notification channel (SMS, Push, e-mail).

**Camera** (Pager4 PRO only): in this section you can select the IP camera which you wish to assign to the given event. IP cameras should be configured in advance in the **“IP cameras”** menu. If you have configured an e-mail notification for the given event, the URL of the IP camera assigned to the event will be sent along with the message in the given e-mail.

Click **“OK”** to accept the changes or **“Cancel”** to quit without saving.



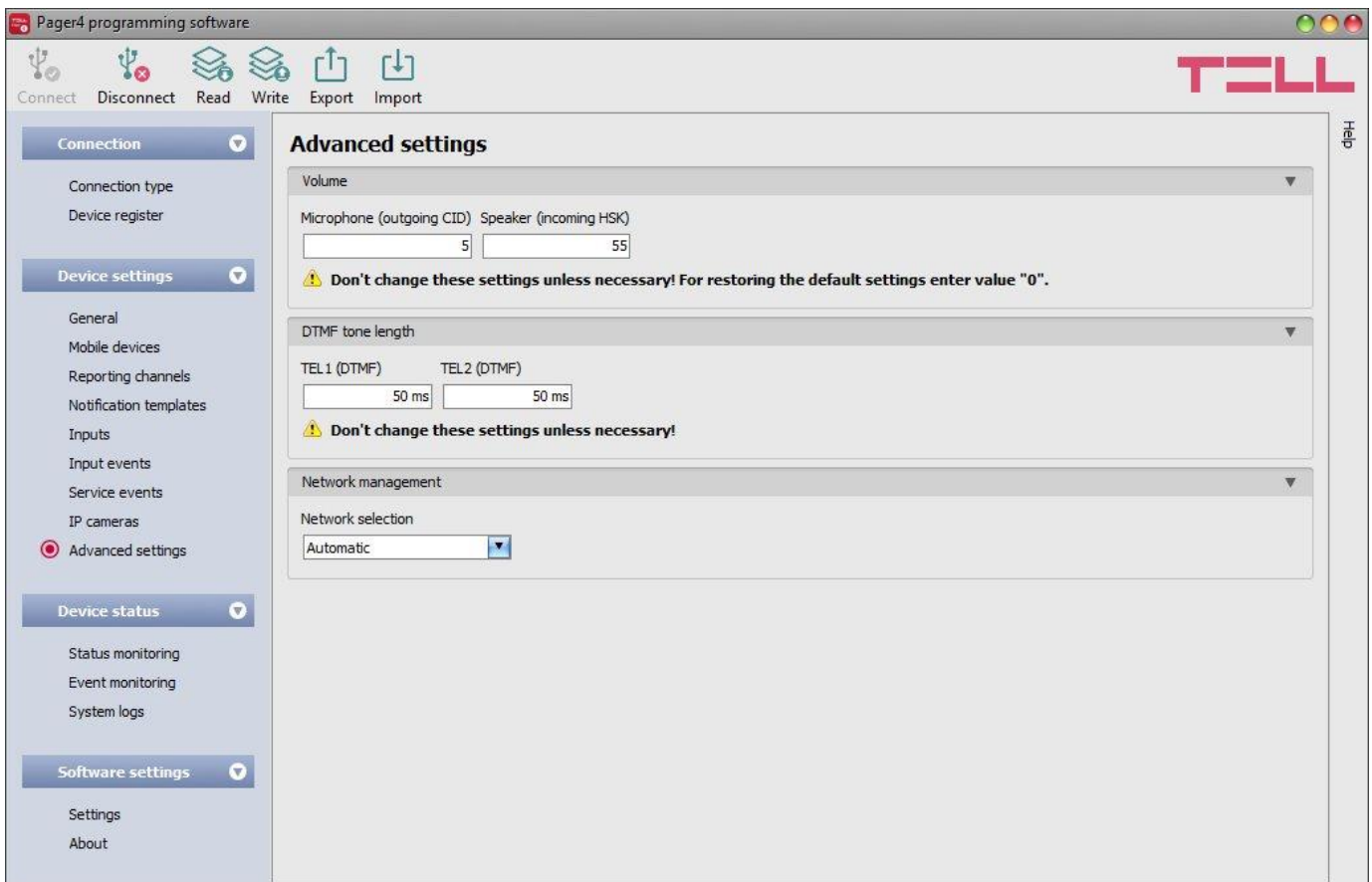

## 5.2.8 Advanced settings



In this menu you can configure advanced settings which affect communication to CMS over DTMF-based voice call, as well as the in-call volume (siren tone, voice messages, DTMF commands). Special DTMF communication parameters can be configured in order to adjust signals in case of experiencing problems with reporting to CMS over DTMF-based voice call.

**Recommended for experts only! Do not change the default settings unless necessary!**

Available options:

- Read the settings from the device:  
 To read the settings from the device click on the “**Read**” button. This will read all settings in all menus.
- Write the settings into the device:  
 After changing the settings or entering new settings, in order to take effect, it is necessary to write the new settings into the device by clicking on the “**Write**” button. This will write the changes only, but all changes made in any menu.
- Save settings to file:  
 To save all device settings to file click on the “**Export**” button.
- Load settings from file:  
 To load saved settings from file click on the “**Import**” button.

**Please note that the settings have to be written in the device in order to be applied after a change is made. For this, click on the “**Write**”  button.**

## Volume:

**Microphone (outgoing CID):** adjusts the microphone volume, which makes outgoing tones (Contact ID, siren tone, voice message) louder or softer in voice calls. The value can be set from 1 to 15.

**Speaker (incoming HSK):** adjusts the speaker volume, which makes incoming tones (HSK and ACK, DTMF commands) louder or softer in voice calls. The value can be set from 1 to 100.

**Note! Even minor changes of the values result significant tone volume changes!**

## DTMF tone length:

**TEL1 (DTMF):** adjusts the length of the DTMF tones which affects calls made to the DTMF receiver configured in section “**TEL1**” in the “**Reporting channels**” menu. The setting also affects the spacing between tones accordingly. The value can be set from 50ms to 1000ms.

**TEL2 (DTMF):** adjusts the length of the DTMF tones which affects calls made to the DTMF receiver configured in section “**TEL2**” in the “**Reporting channels**” menu. The setting also affects the spacing between tones accordingly. The value can be set from 50ms to 1000ms.

## Network management:

**Network selection:** the mobile network management in the device is automatic by default. If you experience problems with the stability of the mobile network in the given location, that is the module switches frequently between networks, you can select the network you wish to use manually.

Available options:

- **Automatic:** the device will select the network automatically.
- **2G only:** use 2G (GPRS) network only.
- **3G only:** use 3G (UMTS) network only

**3G network usage is supported by the 3G.IN4.R2 and the 3G.IN6.R1 models of the Adapter2 only!**

## 5.2.9 IP cameras (Pager4 PRO only)

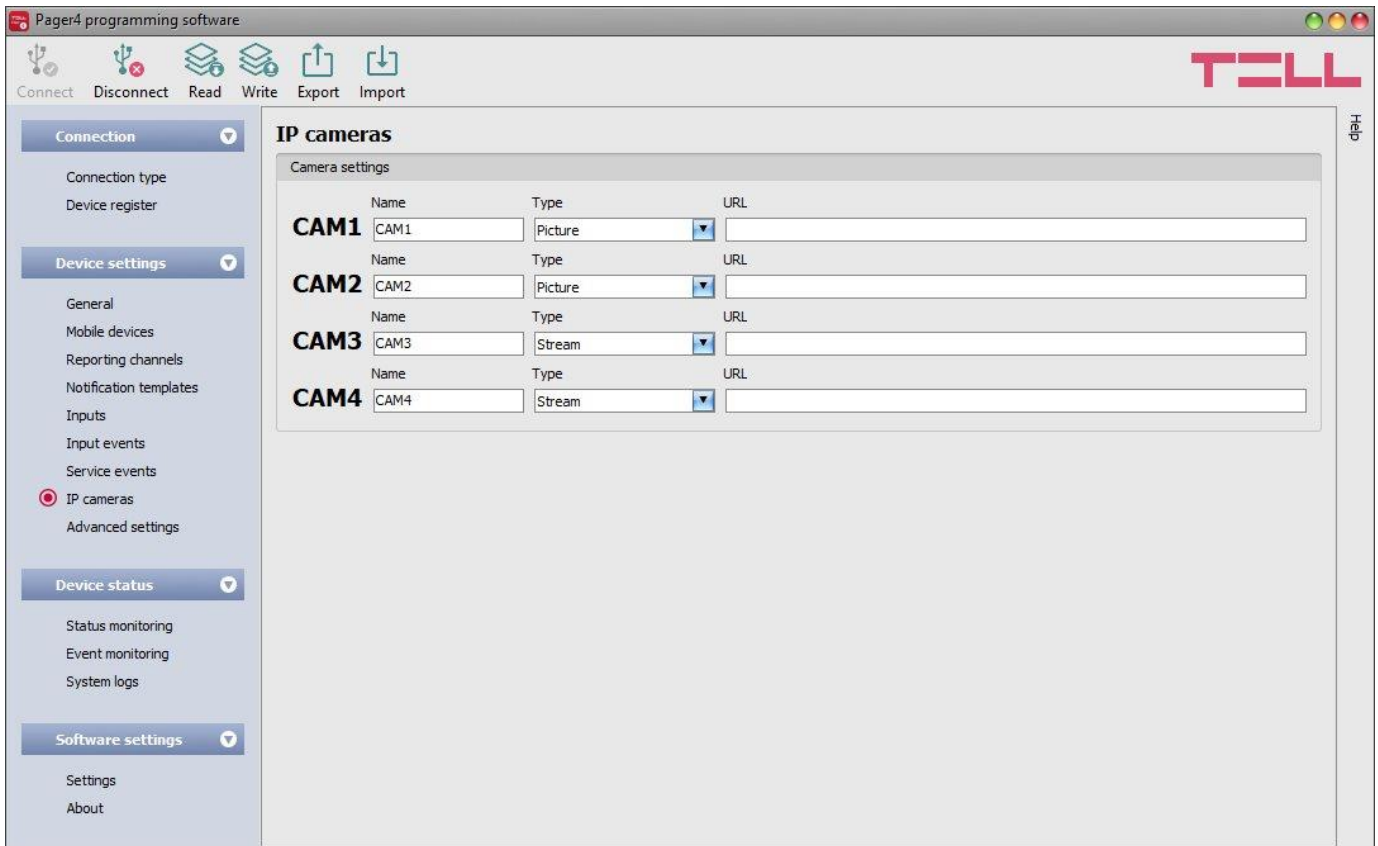

In this menu you can configure the availabilities of up to 4 IP cameras with ONVIF support, which then can be assigned to events in the event settings. If e-mail notifications are configured for events, the URL of the IP camera assigned to the given events will be sent along with the messages in the given e-mails when the events occur.

**Later on camera pictures will be available in the mobile application.** If Push notification is configured for an event, the picture of the IP camera assigned to the given event will be displayed automatically in the mobile application upon receiving the Push notification. **Displaying camera pictures in the mobile application is under development, therefore the current version of the mobile application does not support this yet!**

Available options:

- Read the settings from the device:



To read the settings from the device click on the “**Read**” button. This will read all settings in all menus.

- Write the settings into the device:



After changing the settings or entering new settings, in order to take effect, it is necessary to write the new settings into the device by clicking on the “**Write**” button. This will write the changes only, but all changes made in any menu.

- Save settings to file:



To save all device settings to file click on the “**Export**” button.

- Load settings from file:



To load saved settings from file click on the “**Import**” button.

**Please note that the settings have to be written in the device in order to be applied after a change is made. For this, click on the “**Write**”**  **button.**

## Camera settings:

**Name:** in this section you can enter a custom name for your camera. The name entered in this section will be used for identifying the cameras upon assigning them to events when configuring events.

**Type:** the image transfer mode supported by the IP camera:

- **Stream:** video, continuous content
- **Picture:** still picture

**URL:** the path (link) of the given IP camera.

There are multiple methods to obtain the camera URLs. You can use the “**ONVIF Detector**” software made by the manufacturer (available on the manufacturer’s website: [www.tell.hu](http://www.tell.hu)), the “**ONVIF Device Manager**” software (<http://sourceforge.net/projects/onvifdm>), or the camera’s technical manual.

**In order to access the camera pictures from outside your local network it is necessary to replace the local IP address and port in the URL obtained using the ONVIF URL detector program, with the external (WAN) IP address of your router and the external port, and after this enter the modified URL in the *Pager4* programming software.**

Example for modification of the stream URL, if using only one camera:

**Original URL:**

rtsp://192.168.1.240:554/cam/realmonitor?channel=1&subtype=0&unicast=true&proto=Onvif

**Modified URL in case of using static IP address:**

rtsp://**WAN IP**:554/cam/realmonitor?channel=1&subtype=0&unicast=true&proto=Onvif

**Modified URL in case of using static IP address and username/password:**

rtsp://**username:password@WAN IP**:554/cam/realmonitor?channel=1&subtype....

**Modified URL in case of using domain name:**

rtsp://**domain name**:554/cam/realmonitor?channel=1&subtype=0&unicast=true&proto=Onvif

**Modified URL in case of using domain name and username/password:**

rtsp://**username:password@domain name**:554/cam/realmonitor?channel=1&subtype....

Further details and information on router configuration, port forwarding and dyndns configuration you can find in the “**Reference guide to the ONVIF camera support function**” document.

## 5.3 Device status menu

### 5.3.1 Status monitoring

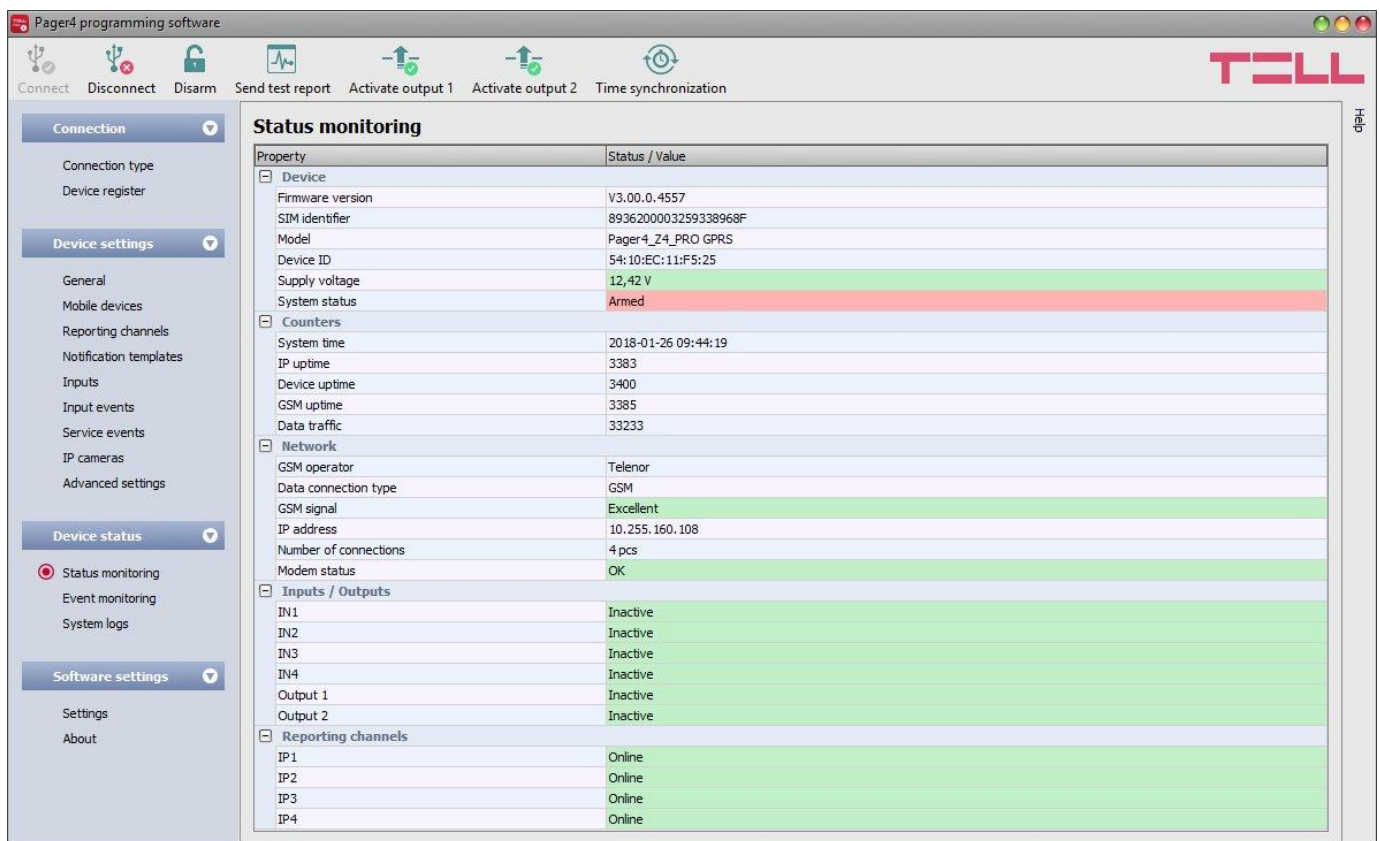

The “**Status monitoring**” menu provides information on actual system status. Please note that for faster communication, in case of remote connection some of the options are not available. Status information loads and refreshes automatically only when connected through USB. In case of remote connection, status information can be loaded or updated by clicking on the “**Query**” button. The states of the control buttons are also updated based on the status information.

- **Firmware version:** the firmware version of the device.
- **SIM identifier:** the identifier (ICCID) of the SIM card installed into the device.
- **Model:** the model of the device.
- **Device ID:** the unique identifier of the **Pager4** device (6x2 hexadecimal characters). This identifier is burned-in during production and thereby it is unchangeable.
- **Supply voltage:** value of measured supply voltage.
- **System status:** armed or disarmed.
- **System time:** the system date and time.
- **IP uptime:** elapsed time since the device has last connected to the Internet.
- **Device uptime:** elapsed time since the device has been powered up.
- **GSM uptime:** elapsed time since the device has last connected to the GSM network.
- **Data traffic:** data traffic since the device has last connected to the Internet.
- **GSM operator:** the name of the GSM operator used actually.
- **Data connection type:** type of actual data connection.
- **GSM signal:** actual GSM signal level (None/Very low, Weak, Medium, Good, Excellent).
- **IP address:** the actual IP address of the device.
- **Number of connections:** the number of active connections with servers/receivers.
- **Modem status:** the actual status of the GSM modem.
- **Inputs/Outputs:** the actual status of the contact inputs (IN1...IN4/IN6) and output(s).
- **Reporting channels:** connection status of the configured servers and IP receivers

When connected to the device locally or remotely, the following options will be available:

- **Query:**



This button appears in case of remote connection only. By clicking on it, status information will be downloaded from the device. This is not needed for USB connection, since in that case the data is downloaded automatically.

- **Arm:**



The device can be armed by clicking on this button. This option is not available if the “**Always armed**” or “**Bistable contact**” option is selected at the “**Arming / Disarming options**” in the “**General**” settings menu.

- **Disarm:**



The device can be disarmed by clicking on this button. This option is not available if the “**Always armed**” or “**Bistable contact**” option is selected at the “**Arming / Disarming options**” in the “**General**” settings menu.

- **Send test report:**



A periodic test report event can be generated by clicking on this button.

- **Activate output 1 (IN4.R2 model only):**



Output OUT1 can be activated by clicking on this button. The output remains activated until deactivated manually or by an event which has been configured to control the given output in a way that deactivates it, or a power loss occurs.

- **Activate output 2 (IN4.R2 model only):**



Output OUT2 can be activated by clicking on this button. The output remains activated until deactivated manually or by an event which has been configured to control the given output in a way that deactivates it, or a power loss occurs.

- **Activate output (IN6.R1 model only):**



The output (OUT1) can be activated by clicking on this button. The output remains activated until deactivated manually or by an event which has been configured to control the given output in a way that deactivates it, or a power loss occurs.

- **Deactivate output 1 (IN4.R2 model only):**



Output OUT1 can be deactivated by clicking on this button.

- **Deactivate output 2 (IN4.R2 model only):**



Output OUT2 can be deactivated by clicking on this button.

- **Deactivate output (IN6.R1 model only):**



The output (OUT1) can be deactivated by clicking on this button.

- **Time synchronization:**



This button is used to synchronize the device system time with the PC system time.



## 5.3.2 Event monitoring

* Date/Time	Name	Source	User ID	Event code	Partition	Zone	IP1	IP2	IP3	IP4	DTMF1 (Call)	TEL1 (SMS)	TEL2 (SMS)	TEL1 (Call)	TEL2 (Call)
2017. 10. 17. 9:54:17	Z2 restore	Input	1234	3130	01	002	*	*	?	?	R	-	-	-	-
2017. 10. 17. 9:54:16	Z2	Input	1234	1130	01	002	*	*	*	*	R	-	*	?	-
2017. 10. 17. 9:49:49	Z1 restore	Input	1234	3130	01	001	*	*	*	*	R	-	-	-	-
2017. 10. 17. 9:49:45	Z1	Input	1234	1130	01	001	*	*	*	*	R	-	-	*	*
2017. 10. 17. 9:49:21	Remote arming	Service event	1234	3407	01	000	*	*	*	*	R	-	-	-	-
2017. 10. 17. 9:49:00	Local disarming	Service event	1234	1409	01	000	*	*	*	*	R	-	-	-	-
2017. 10. 17. 9:48:07	Z2 restore	Input	1234	3130	01	002	*	*	*	*	R	-	-	-	-
2017. 10. 17. 9:48:03	Z2	Input	1234	1130	01	002	*	*	*	*	R	-	*	*	-
2017. 10. 17. 9:47:16	Z1 restore	Input	1234	3130	01	001	*	*	*	*	R	-	-	-	-
2017. 10. 17. 9:47:15	Z1	Input	1234	1130	01	001	*	*	*	*	R	-	-	*	*
2017. 10. 17. 9:46:30	Local arming	Service event	1234	3409	01	000	*	*	*	*	R	-	-	-	-
2017. 10. 17. 9:45:49	Local disarming	Service event	1234	1409	01	000	*	*	*	*	R	-	-	-	-

In this menu the device's event log can be viewed and also enables you to monitor events and reporting progress online. The device stores last 1000 events in its event log.

Available options:

- **Start monitoring:**



By clicking on this button the program will download the stored and will display new events as well. By clicking on the arrow next to this button, you can choose from the drop-down menu, how many events to be displayed in the list: last 10, 20 or all.

- **Stop monitoring:**



Suspends listing of new events. New events will not be listed until event monitoring is restarted.

- **Stop pending notifications:**



By clicking on this button, a command will be sent to the device to cancel pending notifications, which have not been delivered yet. Notifications already in progress will not be terminated.

- **Save to file:**



By clicking on this button, the listed event log can be saved to file in semicolon-separated CSV format.

When connected to the device remotely, the event log can be downloaded only, online monitoring is not available.

Elements of the event log:

- **Date/time:** event occurrence date and time.
- **Name:** event name, according to the event names configured for input and service events.
- **Source:** source of events (input or service).
- **User ID:** the user ID configured for sending reports to CMS.
- **Event code:** the event's Contact ID event code.
- **Partition:** partition number.
- **Zone:** zone number.
- **IP1...IP4:** reporting to IP1...IP4 server/receiver IP addresses.
- **DTMF1...DTMF2:** reporting to DTMF receivers by call.
- **TEL1...TEL10 (SMS):** notifications to phone numbers TEL1...TEL10 by SMS.
- **TEL1...TEL10 (Call):** notifications to phone numbers TEL1...TEL10 by voice call.
- **PUSH1...PUSH4:** notifications to mobile devices 1...4 by Push notification.
- **EMAIL1...EMAIL4:** notifications to addressees 1...4 by e-mail.

Legend of notification status shown in the IP1...IP4, DTMF1...DTMF2, TEL1...TEL10 (SMS), TEL1...TEL10 (Call), PUSH1...PUSH4 and EMAIL1...EMAIL4 columns:

?	New event reporting is in progress.
R	No need to report because reporting to an alternative reporting channel was successful.
*	Reported successfully.
E	Reporting failed, the configured recipient is not available. In case of reporting to CMS, this status occurs after all attempts for sending the report fail. In case of sending notifications by text message or call, this status occurs after 3 failed attempts per message and per call.
-	No server/receiver IP address or user phone number configured.
T	Timeout, the notification could not be delivered in time.

### 5.3.3 System logs

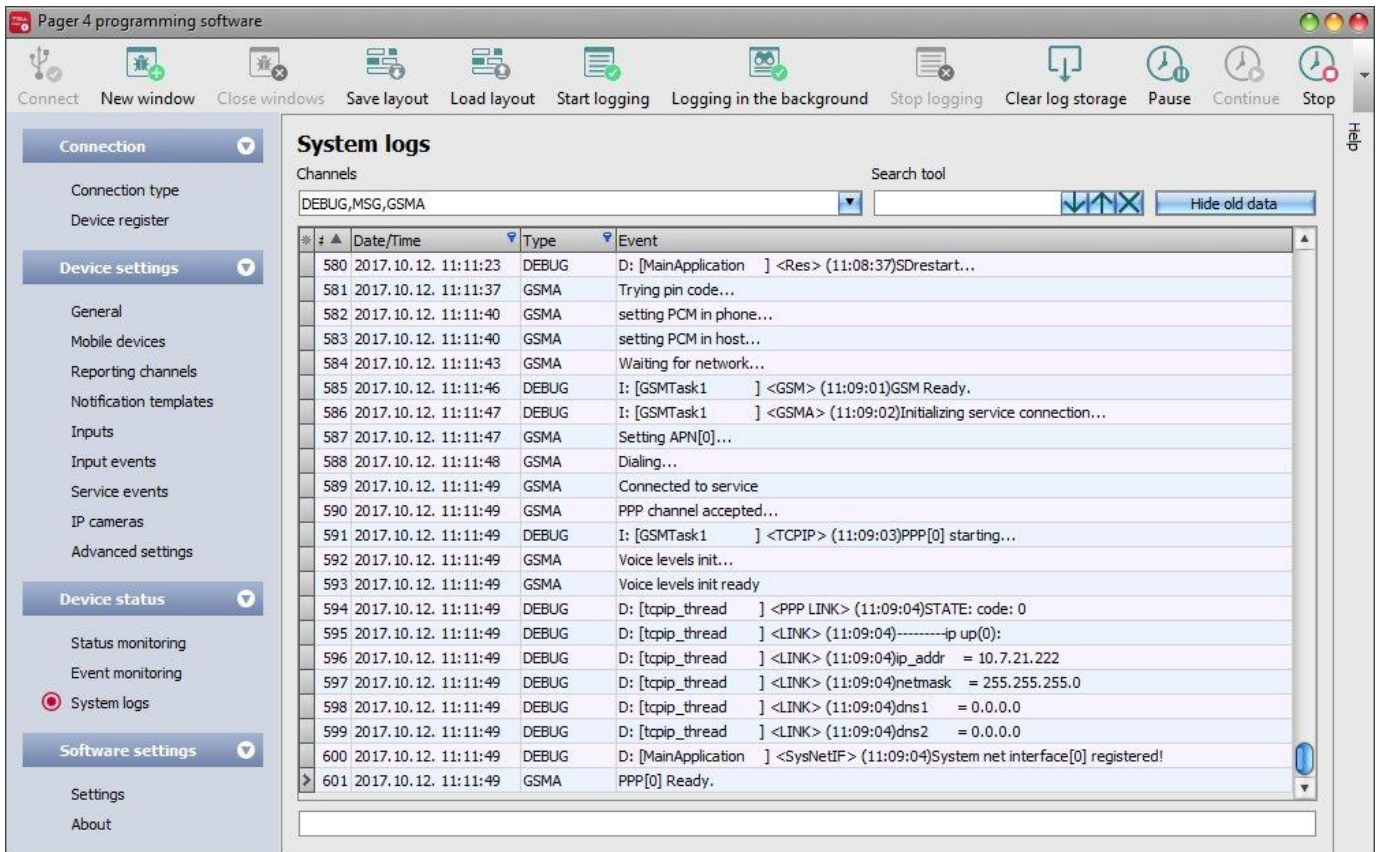













This section shows information about the internal processes of the device and communication. These details help troubleshooting if a malfunction occurs. **This option is only available when connected through USB!**

Based on their nature, information are splitted into channels. You can monitor one or multiple channels simultaneously. Available channels:

- **Debug:** provides details on the general operation of the device
- **MSG:** provides information on the SMS messages sent by the device
- **GSM:** provides information on the operation and status of the GSM modem

Available options:

- Open a new log window:  
 To open a new log window click on the “**New window**” button.
- Close opened log windows:  
 To close all opened log windows click on the “**Close windows**” button.
- Save log window layout:  
 To save the log window layout click on the “**Save layout**” button.
- Load log window layout:  
 To load a saved log window layout click on the “**Load layout**” button, then select the layout to be loaded.
- Start logging to file:  
 To start logging to file click on the “**Start logging**” button.

- Logging in the background:  
 To start logging to in the background click on the “**Logging in the background**” button. During the process the other functions of the system log cannot be used.
- Stop logging to file:  
 To stop logging to file click on the “**Stop logging**” button.
- Load saved log:  
 To load a saved log file click on the „**Load storage**” button. This option is only available when disconnected from the module.
- Clear log storage:  
 To clear the logs stored in the programming software click on the “**Clear log storage**” button.
- Pause logging:  
 To pause logging click on the “**Pause**” button. The entries accumulated while logging is paused will be added to the logs when you continue logging.
- Continue logging:  
 To continue logging click on the “**Continue**” button.
- Stop logging:  
 To stop logging click on the “**Stop**” button. The entries accumulated while stopping logging will not be added to the logs.

Elements of the system logs window:

- **Date/time:** date and time of entry.
- **Identifier:** entry identification number.
- **Type:** information channel type.
- **Event:** event details.

Searching in the system logs is also available. The arrow buttons can be used to switch between results. Using the “**Hide old data**” button it is possible to hide old data in the logs.

## 5.3.4 Software settings

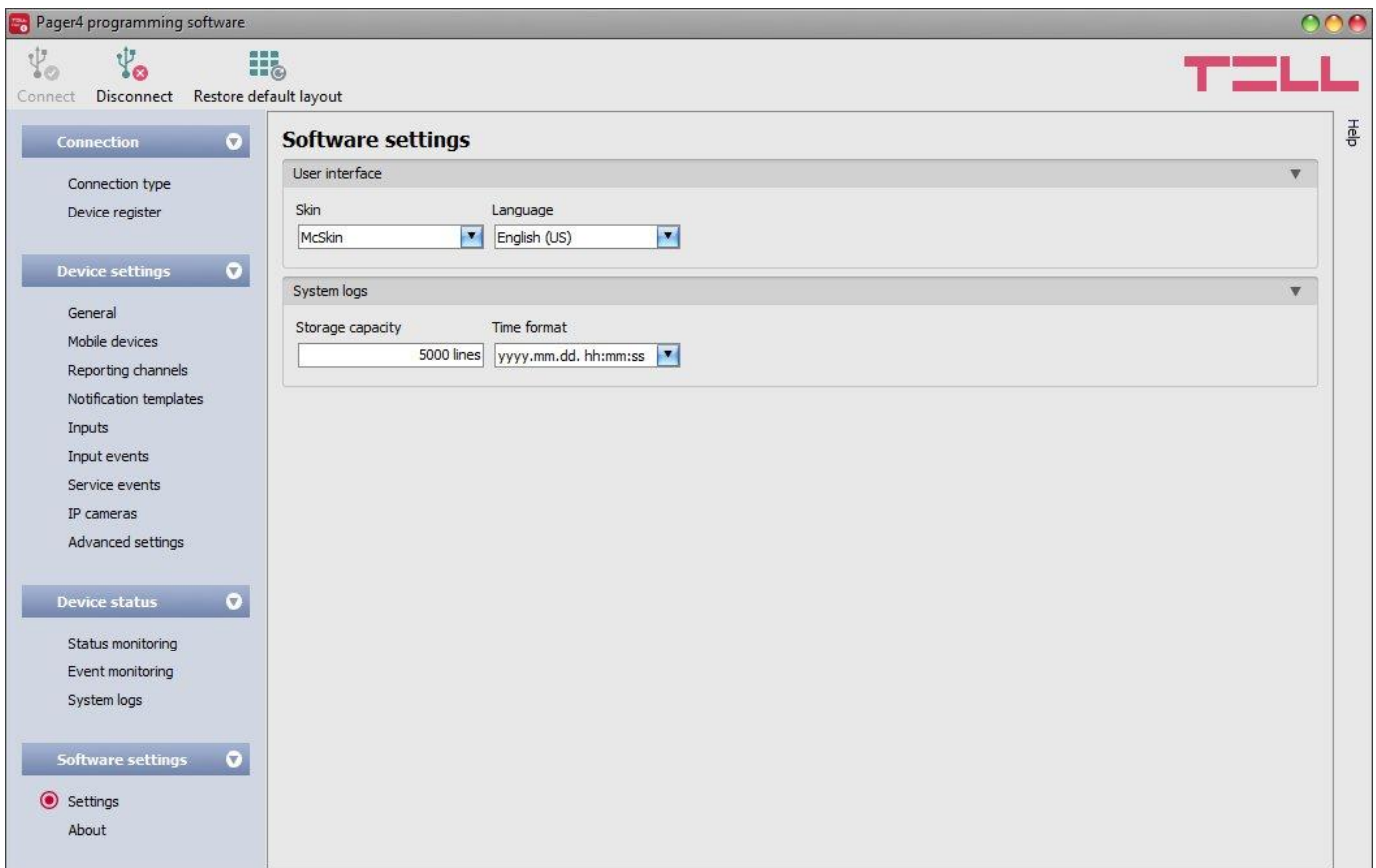

In the “**Settings**” menu you can change the user interface skin, language, and configure certain parameters of the system logs window.

Available options:

- **Restore default layout:**



To restore the user interface default layout click on the “**Restore default layout**” button.

### User interface:

**Skin:** the user interface skin can be changed using the dropdown-menu. You can choose out of multiple appearance themes.

**Language:** the user interface language can be selected from the available languages in the drop-down menu.

### System logs:

**Storage capacity:** in this section you can configure the number of events to be shown at the same time in the “**System logs**” menu. The value can be configured from 50 to 5000 entries.

**Time format:** in this section you can change the date and time format for the entries shown in the system logs and event logs menu.

## 5.3.5 About

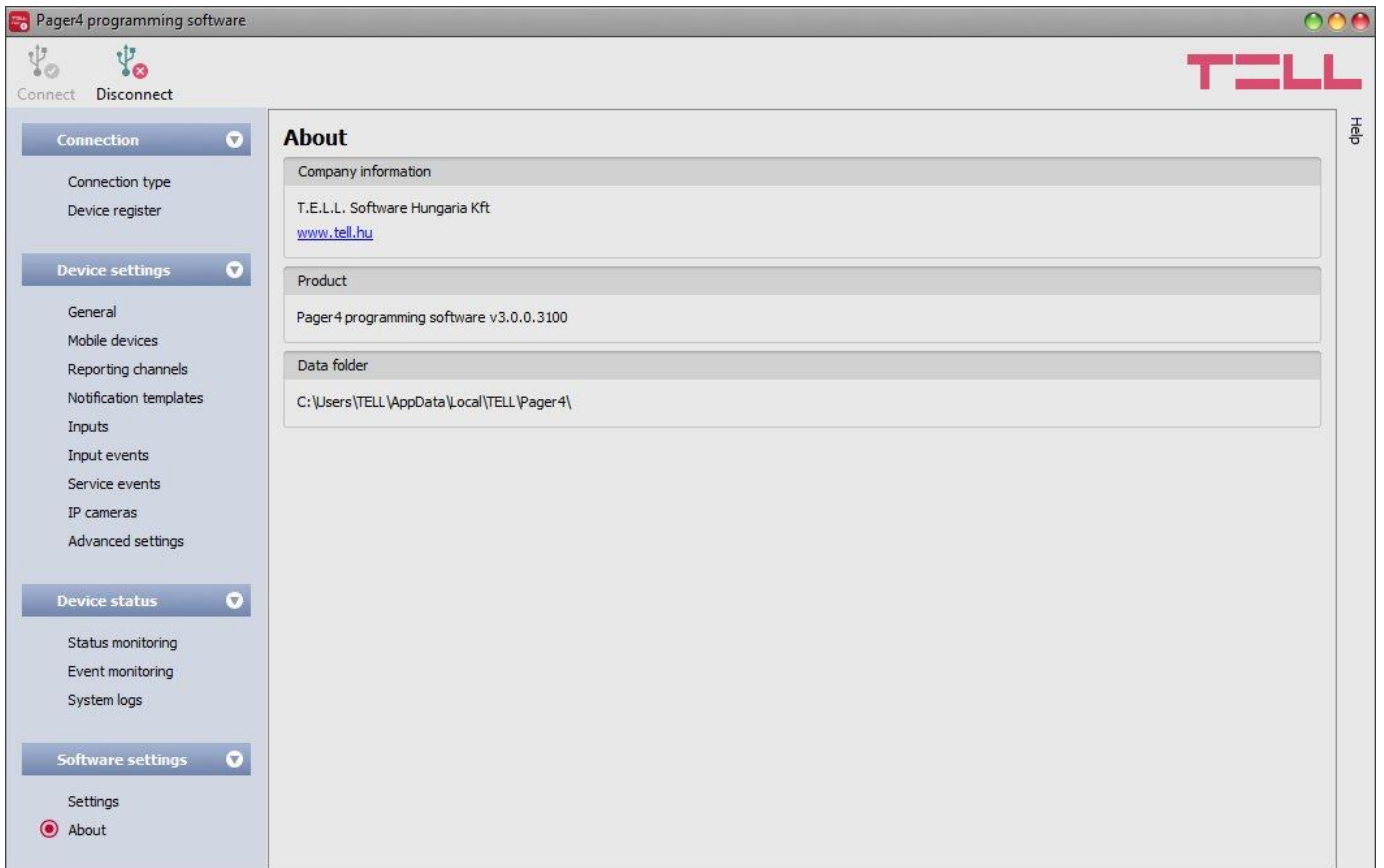

The “**About**” menu shows the availabilities of the manufacturer, the version of the programming software and the path of the data folder where the software stores the logs. By double-clicking on the path, the data folder will be opened in the file manager.

## 6 Controlling the device remotely by DTMF commands and text message

### 6.1 Remote control and status query by DTMF commands via phone call

The device can be controlled and status query can be performed after calling the number of the SIM card installed into the device. In order to gain access to controls, the device password will be requested or not, according to the setting configured in the “**Incoming call management**” section for the given user phone number. When calling from a phone number which is not configured in the device, the password will always be requested. The superadmin and admin passwords are both accepted. Thereafter, the following commands can be used by pressing the phone’s keys:

List of DTMF commands		
Command	Specification	Module response
<b>*9password#</b>	Entering the device password	Password accepted: 3 beeps Wrong password: 4 low-tone beeps
<b>*0#</b>	Disarm	3 beeps
<b>*1#</b>	Arm	6 beeps
<b>*2#</b>	Armed/disarmed status query	Disarmed: 3 beeps Armed: 6 beeps
<b>*4#</b>	GSM signal level query	The signal level will be indicated by a number of beeps from 1 to 5
<b>*3RS#</b>	Control the output(s) R: output (relay) number: <b>1</b> for the IN6.R1 model, <b>1</b> to <b>2</b> for the IN4.R2 model S: output state: <b>0</b> = open, <b>1</b> = closed	Becomes open: 3 beeps Becomes closed: 6 beeps
<b>*3R9#</b>	Output state query R: output number: <b>1</b> for the IN6.R1 model, <b>1</b> to <b>2</b> for the IN4.R2 model	Open: 3 beeps Closed: 6 beeps
<b>*80MM#</b>	Listen to voice messages MM: voice message number: <b>01</b> to <b>15</b>	Playing voice message
<b>*89MM#</b>	Record voice messages MM: voice message number: <b>01</b> to <b>15</b>	Long beep, then recording for 10 seconds, then long beep again
<b>*85MM#</b>	Delete voice messages MM: voice message number: <b>01</b> to <b>15</b>	Successful operation: 3 beeps

#### Example:

1. **Incoming call management** setting: case of option “**Accept call and request password**” and **superadmin** or **admin password: 1234**:
  - a. **Activating output OUT1**:
    - Enter the device password: **\*91234#** (accepted: 3 beeps)
    - Activate output OUT1: **\*311#** (output OUT1 activated/closed: 6 beeps)
  - b. **State query on output OUT1**:
    - Enter the device password: **\*91234#** (accepted: 3 beeps)
    - State query on output OUT1: **\*319#** (if output OUT1 is activated/closed: 6 beeps)
  - c. **Voice message recording to memory slot No. 03**:
    - Enter the device password: **\*91234#** (accepted: 3 beeps)
    - Record message: **\*8903#** (long beep) recording for 10 seconds (long beep)
2. **Incoming call management** setting: case of option “**Accept call and don’t request password**”:
 

**Deactivating output OUT1**: (3 beeps: password accepted) **\*310#** (output OUT1 deactivated/open: 3 beeps)

## 6.2 Remote control and status query by SMS

Controls and status query can be performed by sending commands in SMS to the phone number of the SIM card installed into the device. The following commands can be used:

SMS Command	Specification
<b>*ARM,PWD=yyyy,CRQ#</b>	Arming the device (*please read the note below) If needed, use the CRQ and PWD parameter and substitute "yyyy" with the device password (see specifications below).
<b>*DISARM,PWD=yyyy,CRQ#</b>	Disarming the device (*please read the note below) If needed, use the CRQ and PWD parameter and substitute "yyyy" with the device password (see specifications below).
<b>*R1=ON, PWD=yyyy, CRQ#</b>	Activating output OUT1 (bistable mode) If needed, use the CRQ and PWD parameter and substitute "yyyy" with the device password (see specifications below).
<b>*R1=OFF, PWD=yyyy, CRQ#</b>	Deactivating output OUT1 If needed, use the CRQ and PWD parameter and substitute "yyyy" with the device password (see specifications below).
<b>*R1=ONx, PWD=yyyy, CRQ#</b>	Activating output OUT1 for "x" (1 to 3600) seconds (monostable mode) Substitute parameter "x" with the desired value. If needed, use the CRQ and PWD parameter and substitute "yyyy" with the device password (see specifications below).
<b>*R2=ON, PWD=yyyy, CRQ#</b>	Activating output OUT2 (bistable mode) - IN4.R2 model only If needed, use the CRQ and PWD parameter and substitute "yyyy" with the device password (see specifications below).
<b>*R2=OFF, PWD=yyyy, CRQ#</b>	Deactivating output OUT2 - IN4.R2 model only If needed, use the CRQ and PWD parameter and substitute "yyyy" with the device password (see specifications below).
<b>*R2=ONx, PWD=yyyy, CRQ#</b>	Activating output OUT2 for "x" (1 to 3600) seconds (monostable mode) - IN4.R2 model only Substitute parameter "x" with the desired value. If needed, use the CRQ and PWD parameter and substitute "yyyy" with the device password (see specifications below).
<b>*STATUS, PWD=yyyy#</b>	Requesting status information (the device will send the states of inputs and outputs, armed/disarmed status and GSM signal level in response SMS). If needed, substitute "yyyy" with the device password (see specification below).

\*Arming and disarming will be refused if the "**Always armed**" or "**Bistable contact**" option is selected at the "**Arming / Disarming options**" in the "**General**" settings menu. In these cases the device cannot be armed and disarmed remotely.



**PWD:** the device password can be specified using this parameter. The superadmin and admin passwords are both accepted (default superadmin password: 1234). The **PWD** is an optional parameter which should be used only when sending commands from phone numbers which are not configured in the device, or from ones which are configured, but for which other than the "**Accept call and don't request password**" option is assigned in the "**Incoming call management**" section – such phone numbers are considered unauthorized, therefore in this case the password is required). If the device password is not specified in the control command sent from unauthorized phone numbers, the command will not be executed by the device.

**CRQ** = request confirmation in response SMS (optional parameter, to be used if confirmation is requested). If this parameter is added to the control command, the device will respond to the sender by SMS with information regarding the execution of the command.

Commands should always begin with star "\*" and end with hash "#" character. It is also possible to send multiple commands in one message, but the message should not exceed 60 characters. If the response message to be received from the device would exceed 60 characters, only the first 60 characters will be sent. In case of making mistakes in the command, the following response will be received: "**SYNTAX ERROR!**" and the command(s) will not be executed.

### Responses messages sent by the device (when using the CRQ parameter):

<b>Armed</b>	= the device has been armed
<b>Disarmed</b>	= the device has been disarmed
<b>Arming failed</b>	= the device could not be armed*
<b>Disarming failed</b>	= the device could not be disarmed*
<b>Relay1 activated: 54 sec.</b>	= output OUT1 activated for 54 seconds
<b>Relay1 activated: Permanent.</b>	= output OUT1 activated permanently (bistable mode)
<b>Relay1 deactivated.</b>	= output OUT1 deactivated
<b>Unauthorized User!</b>	= Wrong or missing password

### Examples for command usage:

#### To activate output OUT1 permanently (bistable mode):

- If the command is sent from a phone number for which the "**Accept call and don't request password**" option is selected at incoming call management options and no confirmation is requested, then the command will be: **\*R1=ON#**
- If the command is sent from a phone number for which the "**Accept call and request password**" or the "**Reject call**" option is selected at incoming call management options, then device password will also be required, therefore the command will be:  
**\*R1=ON, PWD=1234#** (if the superadmin or admin password is 1234)
- If the command is sent from a phone number which is not configured in the device and confirmation is requested, then the command will be: **\*R1=ON, PWD=1111, CRQ#**

### Example for module status information sent by the device:

Status information refers to states and values measured in the moment when the device sends the message!

<b>Z1=R</b>	shows the state of inputs IN1...IN4/IN6 ( <b>R</b> =Ready/idle, <b>A</b> =Activated)
<b>Z2=A</b>	
...	
<b>Z6=R</b>	
<b>Armed</b>	shows the armed/disarmed status
<b>R1=ON, 37 sec</b>	shows the state of the output OUT1 ( <b>ON</b> or <b>OFF</b> ), the remaining time till deactivation, or " <b>Permanent</b> " if it has been activated permanently
<b>RF: 23</b>	shows the GSM signal level from 1 to 31

## 7 Factory reset

The factory reset process will clear all settings and event logs in the device and will restore the factory default values!

If you have forgotten the device passwords or would like to clear the device, you can do a factory reset as follows:

- power up the device
- keep the reset microswitch pressed for at least 8 seconds, then release. The reset microswitch is placed in horizontal position on the PCB, near the corner of the SIM card socket, closed to the LED indicator.
- the device will restart after it clears the memory, which takes about 10-20 seconds
- wait at least 1 minute after releasing the microswitch to let the device create the clean configuration.

## 8 Contents of the package

- **Pager4** + terminal connector
- GSM 900/1800 MHz antenna
- User manual, warranty card

## 9 About the manufacturer

T.E.L.L. Software Hungária Kft  
4034 Debrecen, Vágóhíd u. 2.  
Hungary  
Web: [www.tell.hu](http://www.tell.hu)