

suprema

CORPORATE HEADQUARTERS

16F Parkview Tower, 248, Jeongjail-ro, Bundang- gu,
Seongnam-si, Gyeonggi-do, 463-863 Rep. of KOREA
TEL: +82. 31. 783. 4502
FAX: +82. 31. 783. 4503

PRODUCT INQUIRY

sales@supremainc.com

BioStar

IP Access Control & Biometrics



The Future is Easy



Suprema Inc. is a global leader in biometrics and security technology. By combining world renowned biometric algorithms with superior engineering, Suprema is able to continually develop and manufacture reliable industry leading products. Suprema's extensive portfolio of products include biometric access control systems, time & attendance devices, fingerprint/live scanners and embedded fingerprint modules.

Suprema supports worldwide sales network that spans across more than 133 countries around the world and was the first biometrics company listed on Korea's stock market (KOSDAQ 094840).

CONTENTS

PLATFORM

- BioStar 2
- BioStar 1.x

SUPREMA DEVICES BIOMETRIC DEVICES

- FaceStation
- BioStation T2
- BioStation 2
- BioStation
- BioLite Net
- BioEntry W
- BioEntry Plus

RFID DEVICES

- X-Station
- Xpass
- Xpass S2

ACCESSORIES

- Secure I/O
- Lift I/O
- Secure I/O 2
- DM-20
- BioMini

KITS

- Starter Kits

DEVICE OVERVIEW

- Hardware Specifications

ABOUT SUPREMA

- Business Highlights
- Global Sales
- Vertical Market
- Awards



BioStar 2

Web-based Open Security Platform

BioStar 2 sets the new standard in security. The powerful biometric access control framework provides system integrators the ability to easily integrate with 3rd party systems and allows software developers to build new applications & functions into BioStar 2. Accessibility to BioStar 2 and its APIs is further extended through cloud services.

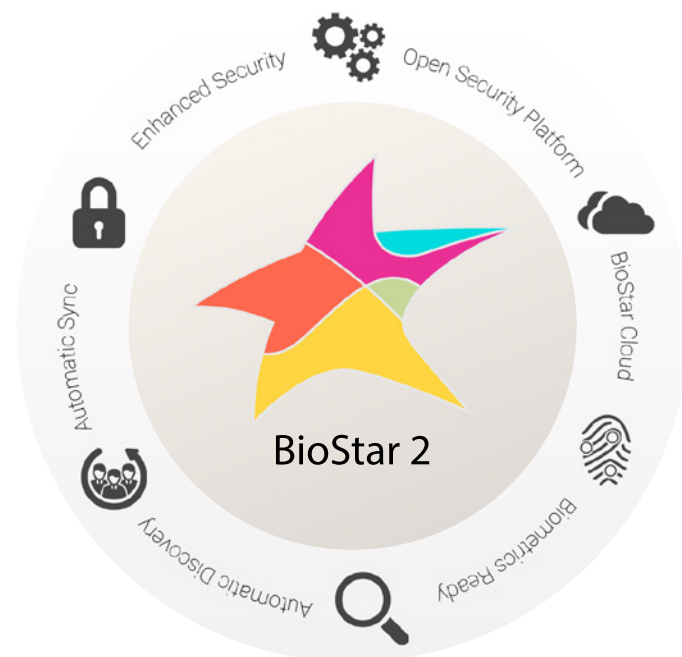

Powerful Open Platform

Build New Functionality into BioStar 2 BioStar 2 Extension Framework

Additional functionality can easily be developed using BioStar 2 extension framework.

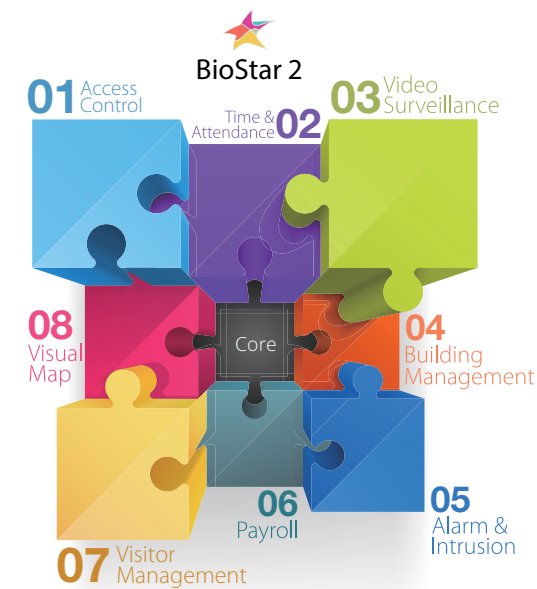

Integrate with 3rd Party Systems

BioStar 2 API

The platform can easily be integrated with 3rd party systems, using BioStar 2 API.

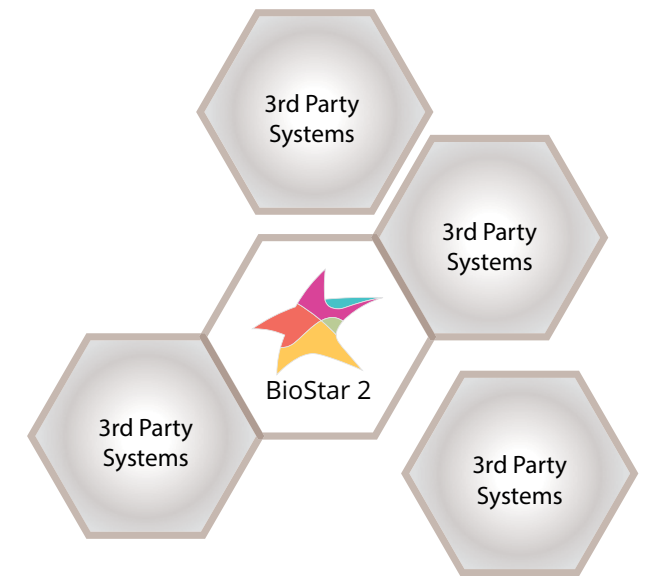

Mobile Ready

BioStar Cloud Services

BioStar Cloud Service provides access to the platform anywhere through mobile solutions.

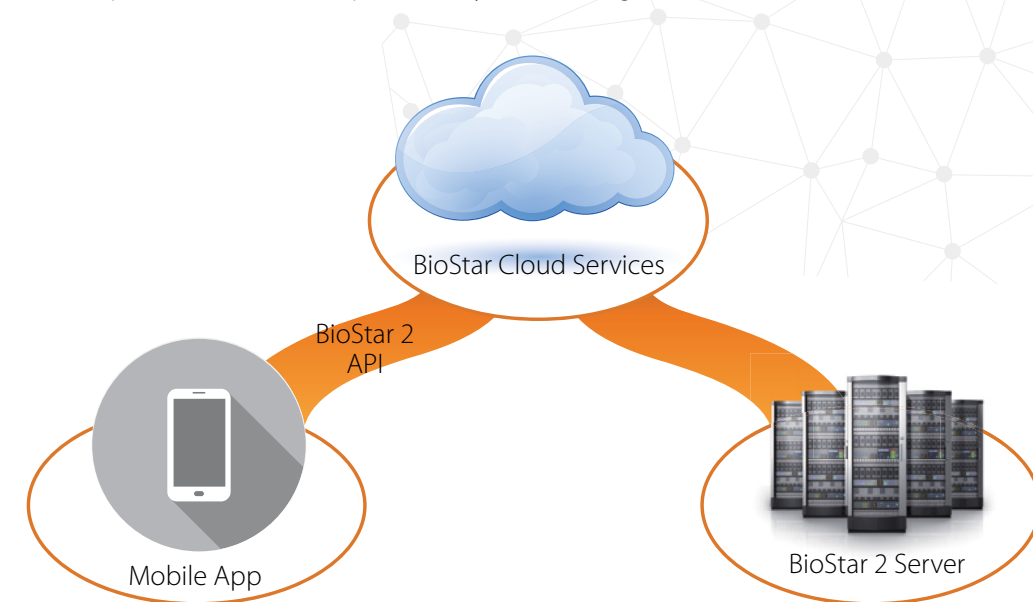

Easy to Use



Automatic user synchronization

New additions, deletions, and modifications of user data on the server will be automatically synchronized on the devices configured on the system.



Automatic device discovery

The feature allows the platform to detect all devices connected within the IP network for configuration and installation.



Automatic update notification via cloud

BioStar 2 receives system update notification through the cloud service. All updates can be installed with a few simple clicks or automatically depending on the system setting.



Simple deployment of sites

The web-server architecture significantly reduces deployment time by removing the need for software installations in client workstations.



Biometrics ready

BioStar 2 seamlessly integrates benefits and convenience of biometrics into the platform for use with access control.

Enhanced Security

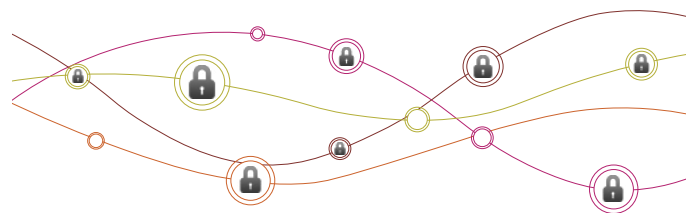

Encrypted Communication

Communication between the server to the client is protected by HTTPS encryption, and communication between server to device is protected by 256bit AES encryption.



Encrypted Information

BioStar 2 also protects user data such as fingerprint, PIN, and password using 256bit encryption standards.

System Topology

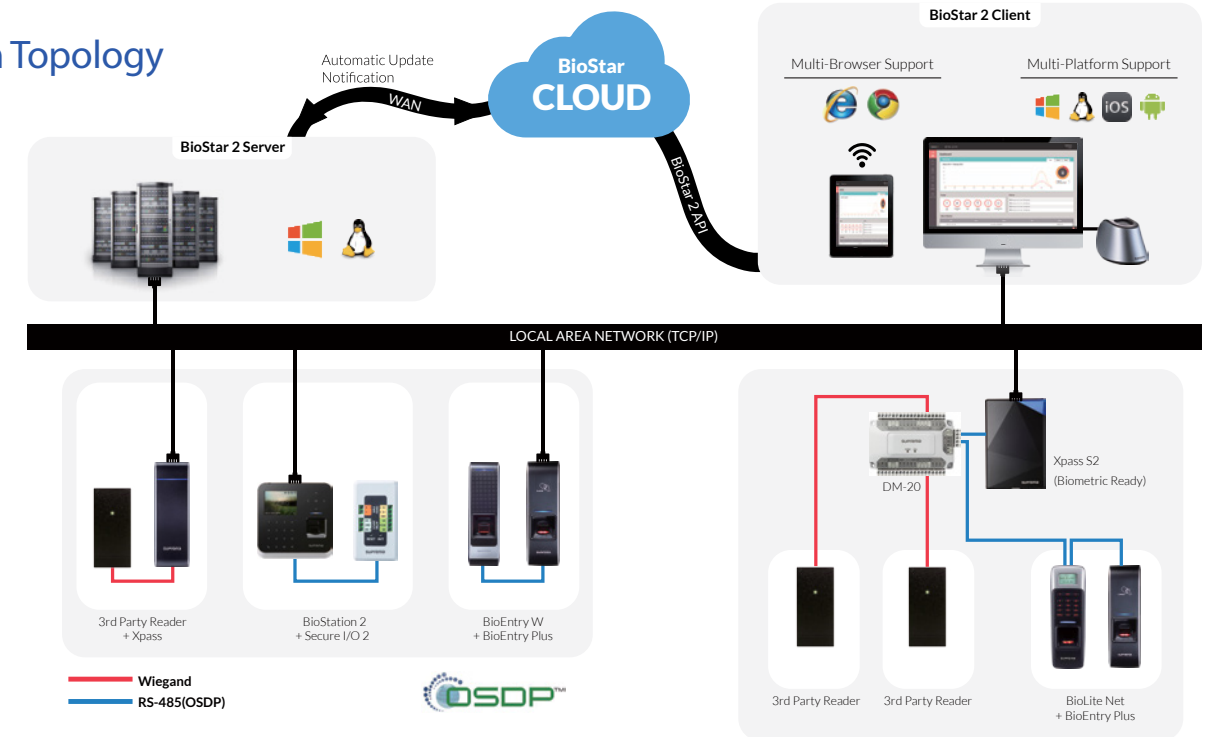

Specifications

System	System Architecture	Web-based
	Operating System	Windows
	DB	SQLite
	Max Device	1000
	Server API	Restful API
	Hyper Data Transfer	Yes
	Concurrent Client PC	100
Access Control	Time Schedule	Unlimited
	Access Group/Level	128
	Max Access Group per User	16
	Max Fingerprints per User	10
	Door	1000
	Zone	Unlock, Lock, APB, Fire Alarm
	Device Administrator	Yes
Extra features	Event Monitoring	Real-time Log, Device Status, Door Status, Alert History
	Dashboard	Yes
	Convert to Printable File	User, Device, Door, Event Log, Alert History
	Automatic Synchronization (User, Access Group)	Yes
	Automatic S/W Update via Cloud	Yes

List of Compatible Devices & Accessories





BioStar 1.x

IP Access Control and Time and Attendance Software

BioStar is a comprehensive access control and time and attendance management software featuring TCP/IP based system architecture with intelligent IP devices and terminals. It supports a wide range of third-party devices and integration with other business systems. It is the optimal solution that results in cost reduction and flexibility in design.

System Topology

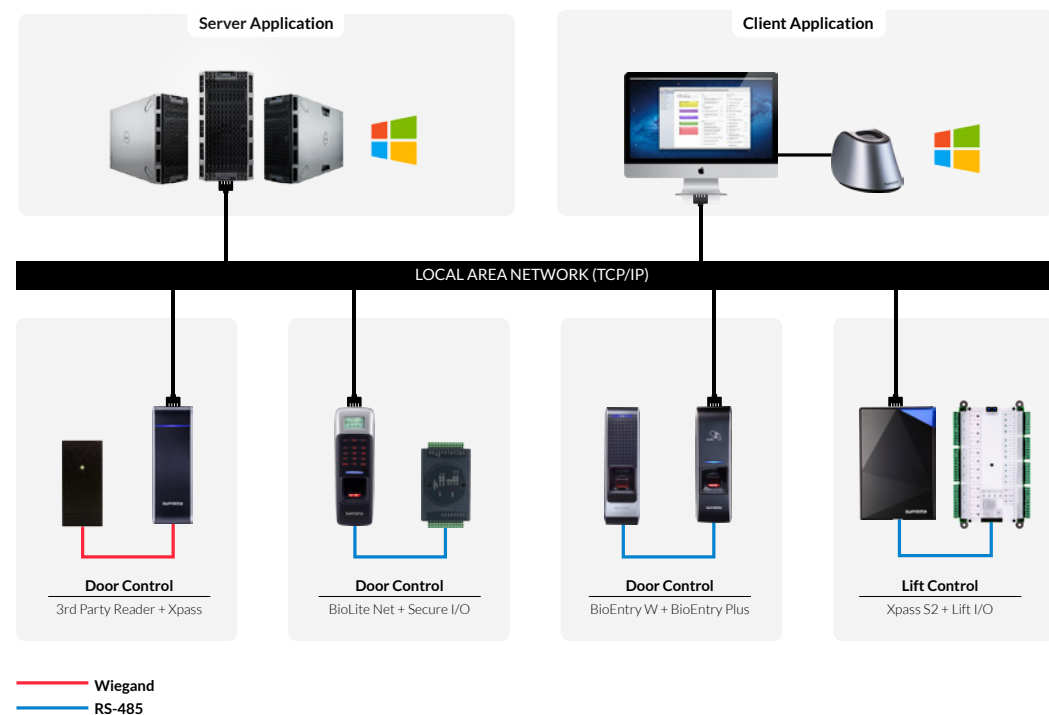

Software Editions

BioStar Basic Edition

BioStar 1.x Basic Edition is an ideal solution for small to medium sized enterprises. The software covers up to 20 devices and supports integration with various database systems, event monitoring, T&A management and reporting features.

BioStar Standard Edition

BioStar 1.x Standard Edition offers powerful and comprehensive access control features for full scale applications. Standard Edition controls up to 512 access control devices with IP camera/NVR integration, anti-passback, muster zone, e-mail notification and visual maps.

Specifications

		BioStar BE	BioStar SE
System	License	Free	USB Dongle
	System Architecture	Client/Server	Client/Server
	Operating System	Windows	Windows
	DB	MSSQL, MySQL, Oracle	MSSQL, MySQL, Oracle
	Server Matching	N/A	Yes
	Max Device	20	512
	Concurrent Client PC	2	32
Access Control	Time Schedule		128
	Access Group/Level		128
	Max Access Group per User		4
	Door	20	512
	Template on Card		Yes
	Zone	N/A	APB, Entrance limit, Alarm, Access, Fire alarm, Muster
	Email Notification	N/A	Yes
	Roll Call	N/A	Yes
	Visual Map	N/A	Yes
	Event Monitoring		Yes
	IP Camera	N/A	Yes
NVR Integration	N/A	Yes	
Lift Management	N/A	Yes (Up to 120 floors)	
Time Attendance	Work time Calculation		Yes
	Shift Management	Weekly	Daily / Weekly
	Holiday/Leave Management		Yes
	Report		Yes
	In/Out Board	N/A	Yes

List of Compatible Devices & Accessories

- FaceStation
- BioStation T2
- BioStation
- BioLite Net
- BioEntry Plus
- BioEntry W
- X-Station
- Xpass
- Xpass S2
- BioMini
- Secure I/O
- Lift I/O

Advanced Access Control

BioStar SE offers key features that allow users to extend the system beyond conventional access control. BioStar SE supports advanced access control zones and a powerful visual map, and lift management for control of up to 120 floors. Camera Integration provides visual log capabilities for a convenient merger of video surveillance and access control.

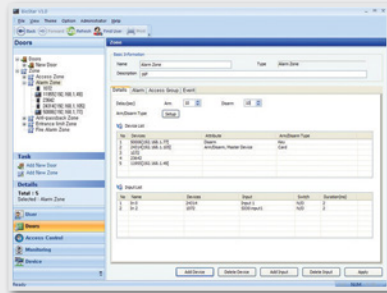

Zone Management

- Fire alarm, alarm, anti-passback, entrance limit, interlock, muster and access zones
- Controls up to 32 advanced zones
- Customizable alarm settings for each zones
- View event log for selected zones

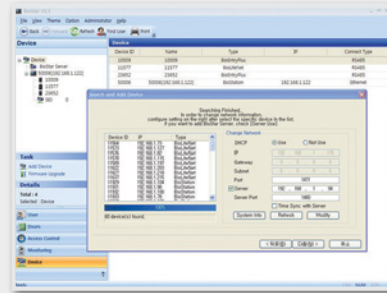

Device Management

- Configure access control devices & I/O peripherals
- Server matching (Biometric matching on the server)
- Real-time monitoring of device connection
- Wizard-type device search interface
- Easy firmware upgrade and reset

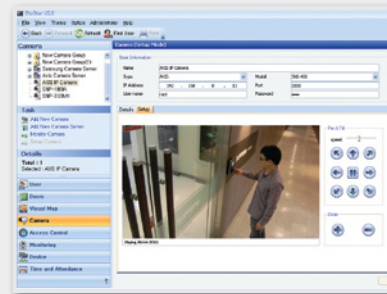

IP Camera & NVR Integration

- Real-time video monitoring
- Still image capturing
- Control of PTZ cameras
- Video log search through NVR

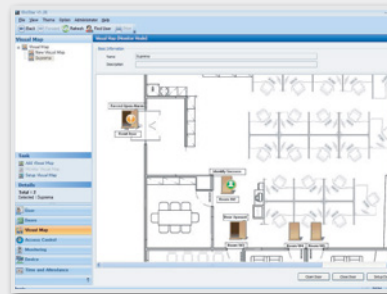

Visual Map Interface

- Graphical representation of the system
- Device/door settings modifications from the map
- Real-time monitoring on the map
- Event notifications in graphic icons
- Monitoring interface for doors and zones

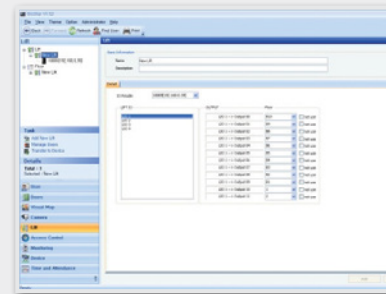

Lift Management

- Control up to 120 floors
- Configurable per floor and user
- Dedicated Lift I/O module support

Time and Attendance Features

BioStar SE includes features that allow administrators to define time categories, shifts, daily schedules and zones holidays. BioStar SE can administer employees to comply with check-in and check-out procedures, restrict access to off-duty personnel and generate attendance report. BioStar SE's Time & Attendance features also give administrators the ability to generate a variety of reports.

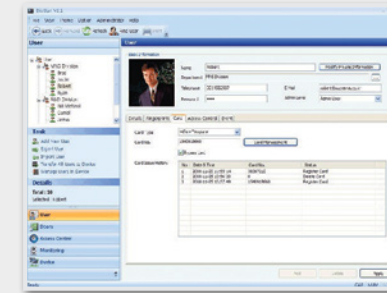

Work Hour Calculation

- User-defined time category configurations
- Daily working schedule configuration
- Overtime calculation
- Rounding & Grace

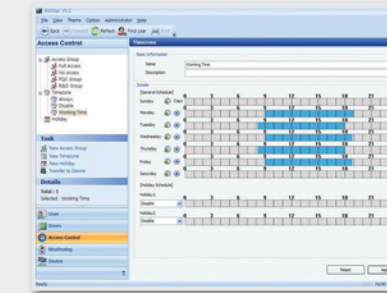

Shift, Holiday & Leave Management

- Daily and Weekly cycle scheduling
- Multiple shift rules per user
- Holiday Schedule configurable per group
- Leave schedule configurable per user

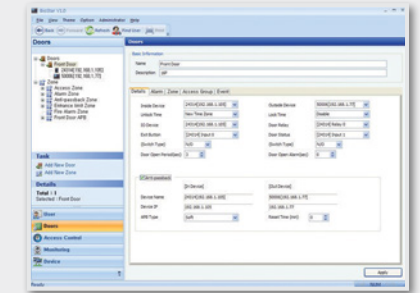

Reporting / Monitoring

- Daily/Individual summary and report
- Report by TA result (such as absence or late)
- Work hour displayed by time category
- CSV Export capability
- Real-time monitoring by T&A event

Distributed IP Access Control

BioStar is Suprema's access control system based on IP connectivity and biometric security. Suprema devices work not only as a reader for multiple types of credentials, but also as an intelligent controller removing the need for a traditional controller.

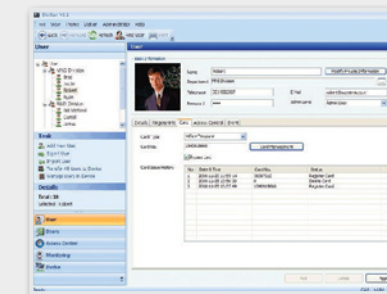

User Management

- Four department levels
- Intuitive user search interface
- Multi-level administrator settings
- Customized authentication mode per user
- Biometric and card credentials

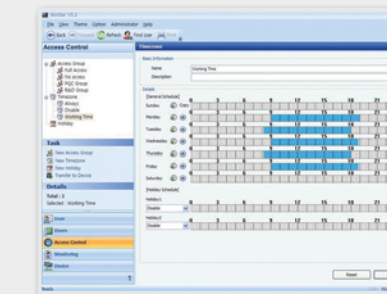

Access Control

- Control up to 128 access groups
- Control up to 128 time schedules
- Up to 32 configurable holidays

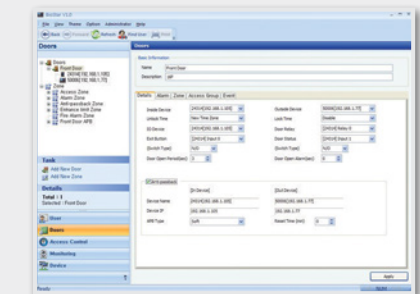

Door Management

- Four door group levels
- Control up to 512 doors
- Alarm features for each door

Suprema Devices

Biometric Devices



RFID Devices



Accessories





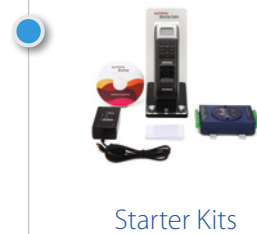

Kits



FaceStation Smart Face Recognition Terminal

Convenient & Secure

FaceStation perfectly combines beauty and performance. By providing contactless authentication at near real-time matching speeds, FaceStation offers unmatched user convenience and enhanced security synonymous with biometrics. It is ideal for applications that require convenient & secure authentication and can be used in either standalone or network environments.

-  Suprema Face Recognition Algorithm
-  Fake Face Detection
-  Intuitive UI
-  Versatile Interface
-  Videophone Capability



Specifications



Capacity	Max User	10,000 (1:1) 1,000 (1:N)
	Max Template	250,000 (1:1) 25,000 (1:N)
	Max Log	1,000,000 (Text) 5,000 (Image)
Interface	Comm.	TCP/IP, RS485, RS232, USB, WiFi (Optional)
	Wiegand	1 ch In or Out
	Input / Output	4 TTL Inputs 2 Relays
H/W	CPU	667MHz RISC + 1.1GHz DSP
	Memory	512MB RAM + 4GB Flash
	LCD	4.3" Color Touch
	Operating Temp.	-20° to 40°C
	Power	12 VDC, PoE (Optional)
	Dimensions	132 x 165 x 60 mm (W x H x D)

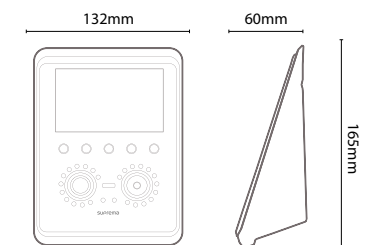





RFID CARD OPTIONS
• 13.56MHz Mifare/DESFire

BioStation T2 High Performance IP Fingerprint Terminal

Smarter Technology, Ultra Performance

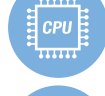
BioStation T2 not only leverages a state-of-the-art device platform to provide an immense variety of features in a single device, but also takes advantage of Suprema's world renowned fingerprint technology to ensure speed and accuracy. It is ideal for applications that require a powerful & reliable hardware and an extensive feature set with a convenient user interface.

-  Suprema Fingerprint Technology
-  Intuitive UI
-  Face Detection
-  Powerful Dual-CPU Architecture
-  Videophone Capability
-  Power-over-Ethernet Support



Specifications



Capacity	Max User	200,000 (1:1) 10,000 (1:N)
	Max Template	400,000 (1:1) 20,000 (1:N)
	Max Log	1,000,000 (Text) 5,000 (Image)
Interface	Comm.	TCP/IP, RS485, RS232, USB, WiFi (Optional)
	Wiegand	1ch In or Out
	Input / Output	4 TTL Inputs 2 Relays
H/W	CPU	667MHz RISC + 533MHz DSP
	Memory	256MB RAM + 1GB Flash
	LCD	5.0" Color Touch
	Operating Temp.	-20° to 50°C
	Power	12VDC, PoE
	Dimensions	155 x 155 x 40 mm (W x H x D)

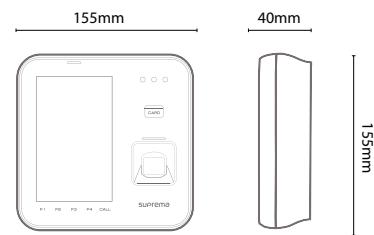





RFID CARD OPTIONS
 • 125KHz EM
 • 13.56MHz Mifare/DESFire

NEW

BioStation 2 Ultra Performance IP Fingerprint Terminal

New Standard in Biometric Access Control

BioStation 2 incorporates the latest Suprema technology in a beautiful exterior. It combines a new powerful processor, Suprema's next generation optical sensor and improved fingerprint sensing & capturing algorithm to offer unrivaled performance. BioStation 2 provides users with instant authentication and rapid data transfer to manage high volume data with ease. It is ideal for applications that requires versatility without compromise in style and performance.

-  Instant Matching & Authentication
-  Rapid Data Transfer
-  Expanded Memory Capacity
-  IP65 Certified Dust and Water Protection
-  Versatile Interface



Specifications



Capacity	Max User	500,000 (1:1) 20,000 (1:N)
	Max Template	1,000,000 (1:1) 40,000 (1:N)
	Max Log	3,000,000 (Text)
Interface	Comm.	TCP/IP, RS485, RS232, USB, WiFi (Built-in)
	Wiegand	1ch In and 1ch Out
	Input / Output	2 Input 2 Output 1 Relay
H/W	CPU	1.0GHz
	Memory	128MB RAM + 8GB Flash
	LCD	2.8" Color
	Operating Temp.	-20°C to 50°C
	Power	12VDC, PoE
	Dimensions	142 x 144 x 45 mm (W x H x D)

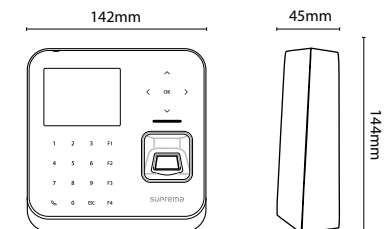







RFID CARD OPTIONS
 • 125KHz EM
 • 125KHz HID Prox
 • 13.56MHz MiFare/DESFire/DesFire EV1/Felica/NFC
 • 13.56MHz iClass SE

BioStation Full-featured IP Fingerprint Terminal

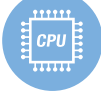
Simple, Powerful, Reliable

BioStation incorporates many fundamental features into a single reliable hardware platform. Its simple user interface allows users to effortlessly interact with the device and its large memory capacity provides storage for a large amount of data. It is the ideal cornerstone of any system requiring fingerprint technology and can be used in either a standalone or network environment.

-  Suprema Fingerprint Technology
-  Interactive UI
-  Dual-CPU Architecture
-  Large Memory Capacity
-  Versatile Interface
-  Interphone



Specifications

Capacity	Max User	200,000 (1:1) 10,000 (1:N)
	Max Template	400,000 (1:1) 20,000 (1:N)
	Max Log	1,000,000 (Text)
Interface	Comm.	TCP/IP, RS485, RS232, USB, WiFi (Optional)
	Wiegand	1ch In and 1ch Out
	Input / Output	2TTL Inputs 1 Relay
H/W	CPU	200MHz RISC + 533MHz DSP
	Memory	34MB RAM + 1GB Flash
	LCD	2.4" Color
	Operating Temp.	-20° to 50°C
	Power	12VDC
	Dimensions	135 x 128 x 50 mm (W x H x D)

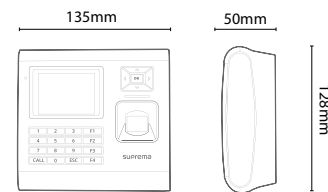





- RFID CARD OPTIONS
- 125KHz EM
 - 125KHz HID Prox
 - 13.56MHz Mifare/DESFire

BioLite Net Smart Outdoor IP Fingerprint Terminal

All-round Excellence

BioLite Net is a compact IP fingerprint terminal that has been designed to fit on a mullion mount. BioLite Net's IP65 rating for protection against dust and water makes it suitable for both indoor & outdoor use and its simple user interface allows for quick easy access to the device. It is ideal for applications that require basic user interaction and a variety of installation environments.

-  Suprema Fingerprint Technology
-  Sleek Unobtrusive Design
-  Environment Protection (IP65)
-  Interactive UI
-  Versatile Interface



Specifications

Capacity	Max User	5,000 (1:1) 5,000 (1:N)
	Max Template	10,000 (1:1) 10,000 (1:N)
	Max Log	50,000 (Text)
Interface	Comm.	TCP/IP, RS485
	Wiegand	1ch In or Out
	Input / Output	2 TTL Inputs 1 Relay
H/W	CPU	533MHz DSP
	Memory	16MB RAM + 8MB Flash
	LCD	1.35" B/W
	Operating Temp.	-20° to 50°C
	Power	12VDC
	Dimensions	60 x 185 x 40 mm (W x H x D)

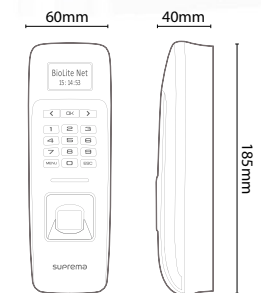

- RFID CARD OPTIONS
- 125KHz EM
 - 13.56MHz Mifare/DESFire

BioEntry W Smart Outdoor IP Fingerprint Device

Rugged & Secure

BioEntry W is a robust high performance fingerprint access control device designed to provide 3-way protection against dust, water and vandalism. BioEntry W also has Power-over-Ethernet capabilities giving it the perfect edge for easy installation. It is ideal for applications that require fingerprint technology and can be used with a variety of installation environments.

-  Suprema Fingerprint Technology
-  Sleek Unobtrusive Design
-  Environment protection (IP65)
-  Vandal Resistant Housing (IK08)
-  Versatile Interface
-  Power-over-Ethernet Support

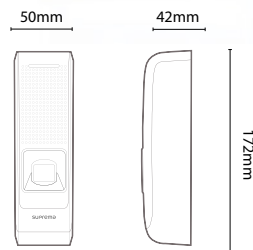

- RFID CARD OPTIONS**
- 125KHz HID Prox
 - 13.56MHz Mifare/DESFire
 - 13.56MHz iCLASS SE/Felica

Specifications







Capacity	Max User	5,000 (1:1) 5,000 (1:N)
	Max Template	10,000 (1:1) 10,000 (1:N)
	Max Log	50,000 (Text)
Interface	Comm.	TCP/IP, RS485
	Wiegand	1ch In or Out
	Input / Output	2 TTL Inputs 1 Relay
H/W	CPU	533MHz DSP
	Memory	8MB RAM + 8MB Flash
	LCD	-
	Operating Temp.	-20° to 50°C
	Power	12VDC, PoE
	Dimensions	50 x 172 x 42 mm (W x H x D)

BioEntry Plus Smart IP Fingerprint Device

Designed for Simplicity

BioEntry Plus exquisitely blends the benefits of an IP access control system with the added security provided by biometrics. It is the base of Suprema's IP fingerprint product line and a good indoor solution to any system requiring fingerprint technology.

-  IP Access Control
-  Suprema Fingerprint Technology
-  Sleek Unobtrusive Design
-  Versatile Interface

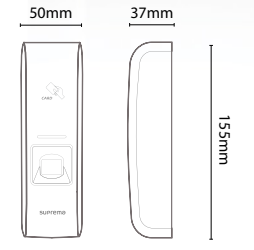

- RFID CARD OPTIONS**
- 125KHz EM
 - 125KHz HID Prox
 - 13.56MHz Mifare/DESFire
 - 13.56MHz iCLASS

Specifications







Capacity	Max User	5,000 (1:1) 5,000 (1:N)
	Max Template	10,000 (1:1) 10,000 (1:N)
	Max Log	50,000 (Text)
Interface	Comm.	TCP/IP, RS485
	Wiegand	1ch In or Out
	Input / Output	2 TTL Inputs 1 Relay
H/W	CPU	533MHz DSP
	Memory	8MB RAM + 8MB Flash
	LCD	-
	Operating Temp.	-20° to 50°C
	Power	12VDC
	Dimensions	50 x 160 x 37 mm (W x H x D)

X-Station Smart IP RFID Terminal

Universal, Secure

X-Station is a formidable device that combines a vast array of components into a slim form factor. X-Station's 3.5" touchscreen LCD provides the perfect interface to an intuitive UI and its camera, speaker and microphone allows for advanced features such as Face Detection and Videophone capabilities. It is a versatile product that can be used in a variety of applications.

-  Intuitive UI
-  Face Detection
-  Large Memory Capacity
-  Versatile Interface
-  Videophone Capability

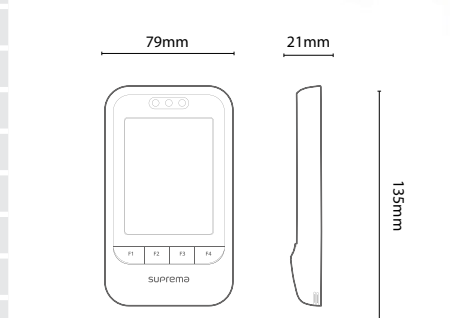

RFID CARD OPTIONS
 • 125KHz EM
 • 13.56MHz Mifare/DESFire







Specifications

Capacity	Max User	200,000
	Max Template	-
	Max Log	1000,000 (Text) 5,000 (Image)
Interface	Comm.	TCP/IP, RS485
	Wiegand	1ch Host and Slave
	Input / Output	2 TTL Inputs 1 Relay
H/W	CPU	667MHz RISC
	Memory	128MB RAM + 1GB Flash
	LCD	3.5" Color touch
	Operating Temp.	-20° to 50°C
	Power	12VDC
	Dimensions	79 x 135 x 21 mm (W x H x D)

Xpass Smart IP RFID Device

Progressive Technology

Xpass effortlessly combines key features of a traditional access control system in a compact form factor and is a cornerstone in Suprema's distributed IP access control system. Xpass can be used in both indoor and outdoor environments and the Power-over-Ethernet connection allows for quick and easy installation.

-  IP Access Control
-  Sleek Unobtrusive Design
-  Environment protection (IP65)
-  Versatile Interface
-  Power-over-Ethernet Support

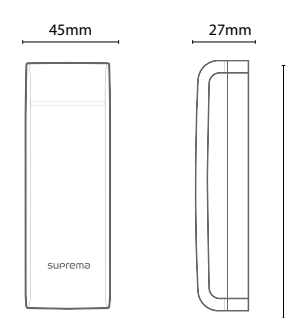

RFID CARD OPTIONS
 • 125KHz EM
 • 125KHz HID Prox
 • 13.56MHz Mifare/DESFire









Specifications

Capacity	Max User	40,000
	Max Template	-
	Max Log	50,000 (Text)
Interface	Comm.	TCP/IP, RS485
	Wiegand	1ch In or Out
	Input / Output	2 TTL Inputs 1 Relay
H/W	CPU	533MHz DSP
	Memory	16MB RAM + 8MB Flash
	LCD	-
	Operating Temp.	-20° to 50°C
	Power	12VDC, PoE
	Dimensions	45 x 130 x 27 mm (W x H x D)

Xpass S2 Ultra Slim Smart IP RFID Device

Revolution in Access Control

Xpass S2 effortlessly combines key features of a traditional access control system in a ultra slim form factor and is a cornerstone in Suprema's distributed IP access control system. Xpass S2 is designed to withstand a wider temperature range and can read multiple smartcard technologies making it an ideal product for harsh weather environments.

-  IP Access Control
-  Multi-Smartcard Reader
-  Environment protection (IP65)
-  Ultra Slim Design
-  Adaptive Temperature Control
-  Versatile Interface



Specifications



Capacity	Max User	50,000
	Max Template *	1,000 (Supported in BioStar 2 Only)
	Max Log	100,000 (Text)
Interface	Comm.	TCP/IP, RS485
	Wiegand	1ch In or Out
	Input / Output	2 TTL Inputs 1 Relay
H/W	CPU	533MHz DSP
	Memory	16MB RAM + 16MB Flash
	LCD	-
	Operating Temp.	-35° to 65°C
	Power	12VDC
	Dimensions	80 x 120 x 11.4 mm (W x H x D)

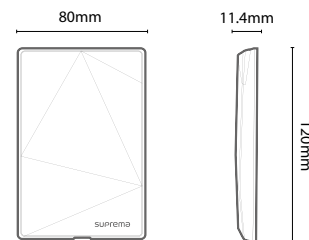

RFID CARD OPTIONS
• 13.56MHz Mifare/DESFire/Felica

Secure I/O

Secure I/O Expansion Module

Secure I/O provides secure door control as well as I/O expansion via encrypted communication when combined with other Suprema devices.



Specifications



Interface	Comm.	RS485
	Inputs	4x TTL
	Relay	2x Form C
H/W	Power	12 VDC(500 mA)
	Operating Temp.	-20° to 50°C
	Dimensions	142.5 x 81.9 x 39 mm (W x H x D)

※ Compatible S/W : BioStar 1.x Only

Configuration

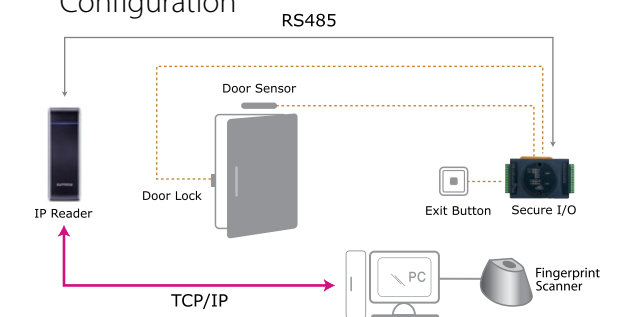

Lift I/O

Secure Floor Access Control I/O Module

Lift I/O is purpose built expansion module designed for elevator floor access control. Combined with a Suprema device and BioStar software, a single module can securely control up to 12 floors via encrypted connection. Lift I/O can be linked in daisy chain configuration up to 10 devices for control of 120 floors.

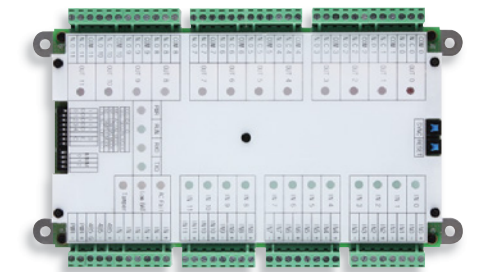

Specifications



Interface	Comm.	RS485
	Inputs	12x TTL
	Relay	12x Form C
H/W	Power	12 VDC
	Operating Temp.	-20° to 50°C
	Dimensions	140 x 240 x 32 mm (W x H x D)

※ Compatible S/W : BioStar 1.x Only

Configuration

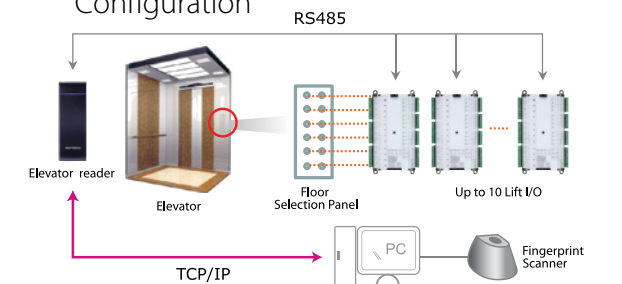

NEW

Secure I/O 2

Compact Secure One Door I/O Module

Secure I/O 2 provides secure door control via encrypted communication when combined with other Suprema devices. Its ultra-compact form factor allows for use in a variety of installation environments.



Configuration

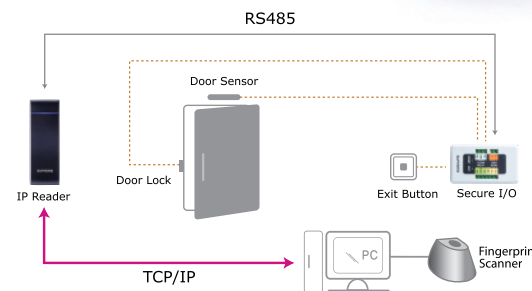

Specifications



Interface	Comm.	RS485
	Inputs	2x TTL
	Relay	1x Form C
H/W	Power	12 VDC(100 mA)
	Operating Temp.	-20° to 60°C
	Dimensions	36 x 65 x 18 mm (W x H x D)

※ Compatible S/W : BioStar 2 Only

BioMini

USB Fingerprint Enrollment Device

BioMini provides system operators the ability to enroll fingerprints from any PC running a BioStar Client.

Specifications



Sensor	Optical (IP65 sensor surface)
Resolution	500 DPI/ 256 grey
Sensing Area	16 x 18mm
Image Size	288 x 320 pixels
Interface	USB 2.0 High Speed
Operating Temp.	-10° to 50°C
Dimensions	66 x 90 x 58 mm (W x H x D)

※ Compatible S/W : BioStar 1.x, BioStar 2.0



NEW

DM-20

Secure Two Door I/O Module

DM-20 provides secure door control of up to two doors via encrypted communication and also contains two Wiegand reader interfaces for use with 3rd party readers. A wide variety of I/O interfaces allows DM-20 to be a part of diverse system configurations.



Specifications

Interface	Comm.	RS485
	Input	TTL Input X 6 Supervised Input X 2
	Output	TTL Output X 6
H/W	Relay	4x Form C
	Wiegand	In/Out X 2
	Reader Power output	750mA(12V) x2
	Power	12V
	Operating Temp.	-20°C to 60°C
	Dimensions	120 x 70 x 36 mm (W x H x D)

※ Compatible S/W : BioStar 2 Only

Starter Kits

Essential Components for Evaluation

Suprema Starter Kits provide users with the fundamental components to experience Suprema's IP access control system.

Components

- Suprema Device
- 12VDC Power Adaptor
- Plastic Stand
- Secure I/O (Select models only)
- Command Cards (Select models only)
- BioStar Software
- BioStar SDK
- Technical Documents



Hardware Specification

Category	Feature	FaceStation	BioStation T2	BioStation 2	BioStation
Suprema Device Portfolio					
					
Main	Biometric	Face	Fingerprint	Fingerprint	Fingerprint
	IP Rating	-	-	IP65	-
	RF Option	13.56MHz Mifare/DESFire	125KHz EM 13.56MHz Mifare/ DESFire	125KHz EM 125KHz HID Prox 13.56MHz MiFare/DESFire /DesFire EV1/Felica/NFC 13.56MHz iClass SE	125KHz EM 125KHz HID Prox 13.56MHz Mifare/ DESFire
Capacity	Max User (1:1)	10,000	200,000	500,000	200,000
	Max User (1:N)	1,000	10,000	20,000	10,000
	Max Template (1:1)	250,000	400,000	1,000,000	400,000
	Max Template (1:N)	25,000	20,000	40,000	20,000
	Max Text Log	1,000,000	1,000,000	3,000,000	1,000,000
	Max Image Log	5,000	5,000	-	-
Interface	WiFi	Optional	Optional	Yes(Built-in)	Optional
	TCP/IP	Yes	Yes	Yes	Yes
	RS-485	1ch Host and 1ch Slave	1ch Host and 1ch Slave	1ch Host or Slave	1ch Host or Slave
	RS-232	Yes	Yes	Yes	Yes
	Wiegand	1ch In or Out	1ch In or Out	1ch In and 1ch Out	1ch In and 1ch Out
	Input	4 Inputs	4 Inputs	2 Inputs / 2 Outputs	2 Inputs
	Relay	2 Relays	2 Relays	1 Relays	1 Relays
	USB	Host and Slave	Host and Slave	USB 2.0 (Host)	Host and Slave
Hardware	CPU	667MHz CPU + 1.1GHz DSP	667MHz CPU + 533MHz DSP	1.0GHz	200MHz CPU + 533MHz DSP
	Memory	512MB RAM + 4GB Flash	256MB RAM + 1GB Flash	128MB RAM + 8GB Flash	34MB RAM + 1GB Flash
	LCD	4.3" Color Touch	5.0" Color Touch	2.8" Color LCD	2.5" Color
	LED Indicator	-	Multi-Color	Multi-Color	Blue
	Sound	16-bit Hi-Fi	16-bit Hi-Fi	16-bit Hi-Fi	16-bit Hi-Fi
	Operating Temp.	-20° to 40°C	-20° to 50°C	-20° to 50°C	-20° to 50°C
	Tamper	Yes	Yes	Yes	Yes
	Power	12VDC	12VDC	12VDC	12VDC
	PoE	Optional	Yes	Yes	-
	Dimensions (W x H x D mm)	132 x 165 x 60	155 x 155 x 40	142 x 144 x 45	135 x 128 x 50
	Certificates	CE, FCC, KC, RoHS	CE, FCC, KC, RoHS	CE, FCC, KC, RoHS	CE, FCC, KC, RoHS
	Compatibility ¹	BioStar 1.x	Yes	Yes	-
BioStar 2		-	-	Yes	-

¹ Requires F/W Update

BioLite Net	BioEntry W	BioEntry Plus	X-Station	Xpass	Xpass S2
					
Fingerprint	Fingerprint	Fingerprint	-	-	-
IP65	IP65	-	-	IP65	IP65
125KHz EM 13.56MHz Mifare/ DESFire	125KHz HID Prox 13.56MHz Mifare/DESFire 13.56MHz iCLASS SE/Felica	125KHz EM 125KHz HID Prox 13.56MHz Mifare/DESFire 13.56MHz iCLASS	125KHz EM 13.56MHz Mifare/DESFire	125KHz EM 125KHz HID Prox 13.56MHz Mifare/DESFire	13.56MHz Mifare/ DESFire/Felica
5,000	5,000	5,000	200,000	40,000	50,000
5,000	5,000	5,000	200,000	40,000	50,000
10,000	10,000	10,000	-	-	-
10,000	10,000	10,000	-	-	-
50,000	50,000	50,000	1,000,000	50,000	100,000
-	-	-	5,000	-	-
-	-	-	-	-	-
Yes	Yes	Yes	Yes	Yes	Yes
1ch Host or Slave	1ch Host or Slave	1ch Host or Slave	1ch Host and Slave	1ch Host or Slave	1ch Host or Slave
-	-	-	Yes	-	-
1ch In or Out	1ch In or Out	1ch In or Out	1ch In or Out	1ch In or Out	1ch In or Out
2 Inputs	2 Inputs	2 Inputs	2 Inputs	2 Inputs	2 Inputs
1 Relay	1 Relay	1 Relay	1 Relay	1 Relay	1 Relay
-	-	-	-	-	-
533MHz DSP	533MHz DSP	533MHz DSP	667MHz RISC	533MHz DSP	533MHz DSP
16MB RAM + 8MB Flash	8MB RAM + 8MB Flash	8MB RAM + 8MB Flash	128MB RAM + 1GB Flash	16MB RAM + 8MB Flash	16MB RAM + 16MB Flash
128x64 Graphic LCD (Monochrome)	-	-	3.5" Color Touch	-	-
Multi-Color	Multi-Color	Multi-Color	-	Multi-Color	Multi-Color
Multi-tone Buzzer	Multi-tone Buzzer	Multi-tone Buzzer	16-bit Hi-Fi	Multi-tone Buzzer	Multi-tone Buzzer
-20° to 50°C	-20° to 50°C	-20° to 50°C	-20° to 50°C	-20° to 50°C	-35° to 65°C
Yes	Yes	Yes	Yes	Yes	Yes
12VDC	12VDC	12VDC	12VDC	12VDC	12VDC
-	Yes	-	-	Yes	-
60 x 185 x 40	50 x 172 x 42	50 x 160 x 37	79 x 135 x 21	45 x 130 x 27	80 x 120 x 11.4
CE, FCC, KC, RoHS	CE, FCC, KC, RoHS	CE, FCC, KC, RoHS	CE, FCC, KC, RoHS	CE, FCC, KC, RoHS	CE, FCC, KC, RoHS
Yes	Yes	Yes	Yes	Yes	Yes
Yes	Yes	Yes	-	Yes	Yes

Business Highlights

Company at a Glance

Headquarter	South Korea
Foundation	May 4, 2000
Business Area	Access Control and Time & Attendance Embedded Modules ID Scanners
Global Business	133 Countries worldwide over 1,000 customers (2014) Market Capital USD 436 Million (2014)
Growth	CAGR of 38% (2006-2014)
Financial Status	Listed company in South Korea's stock exchange (KOSDAQ)

Key Solutions & Technologies

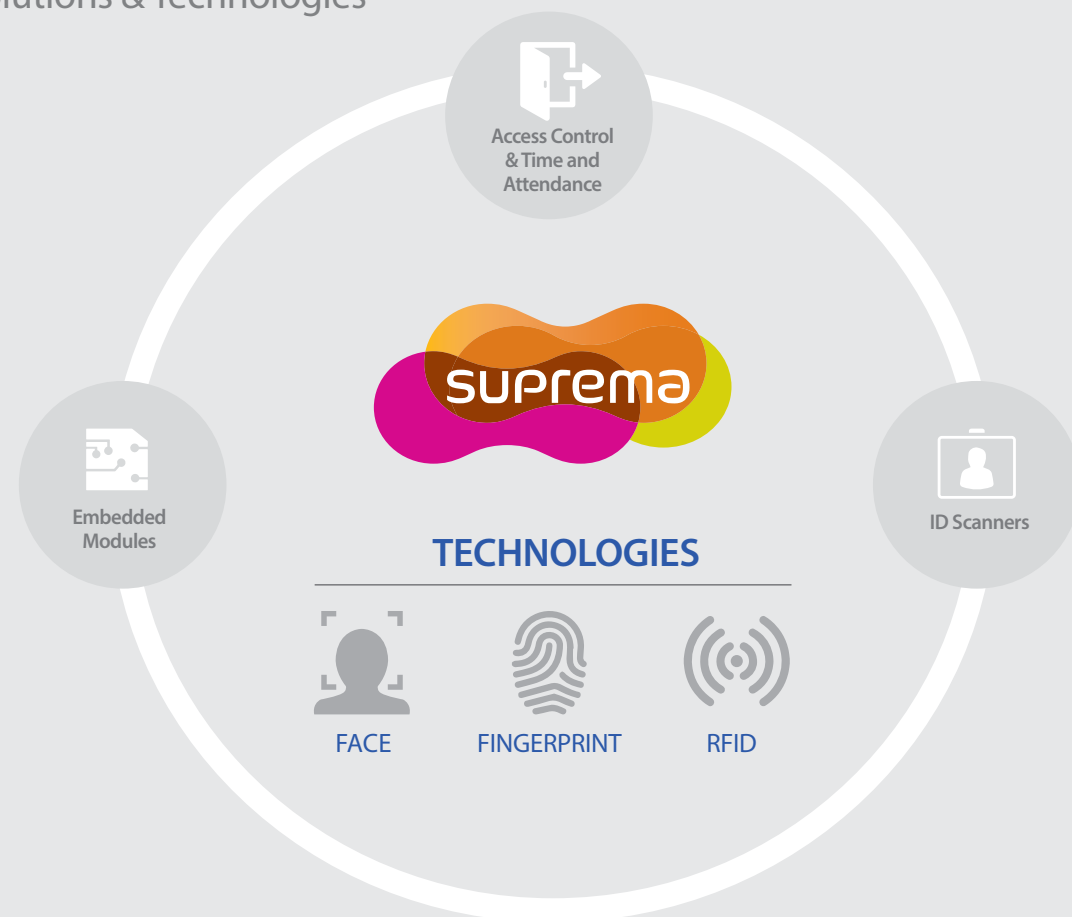

Global Sales

Stable revenue stream from over 950 Customers across 133 countries

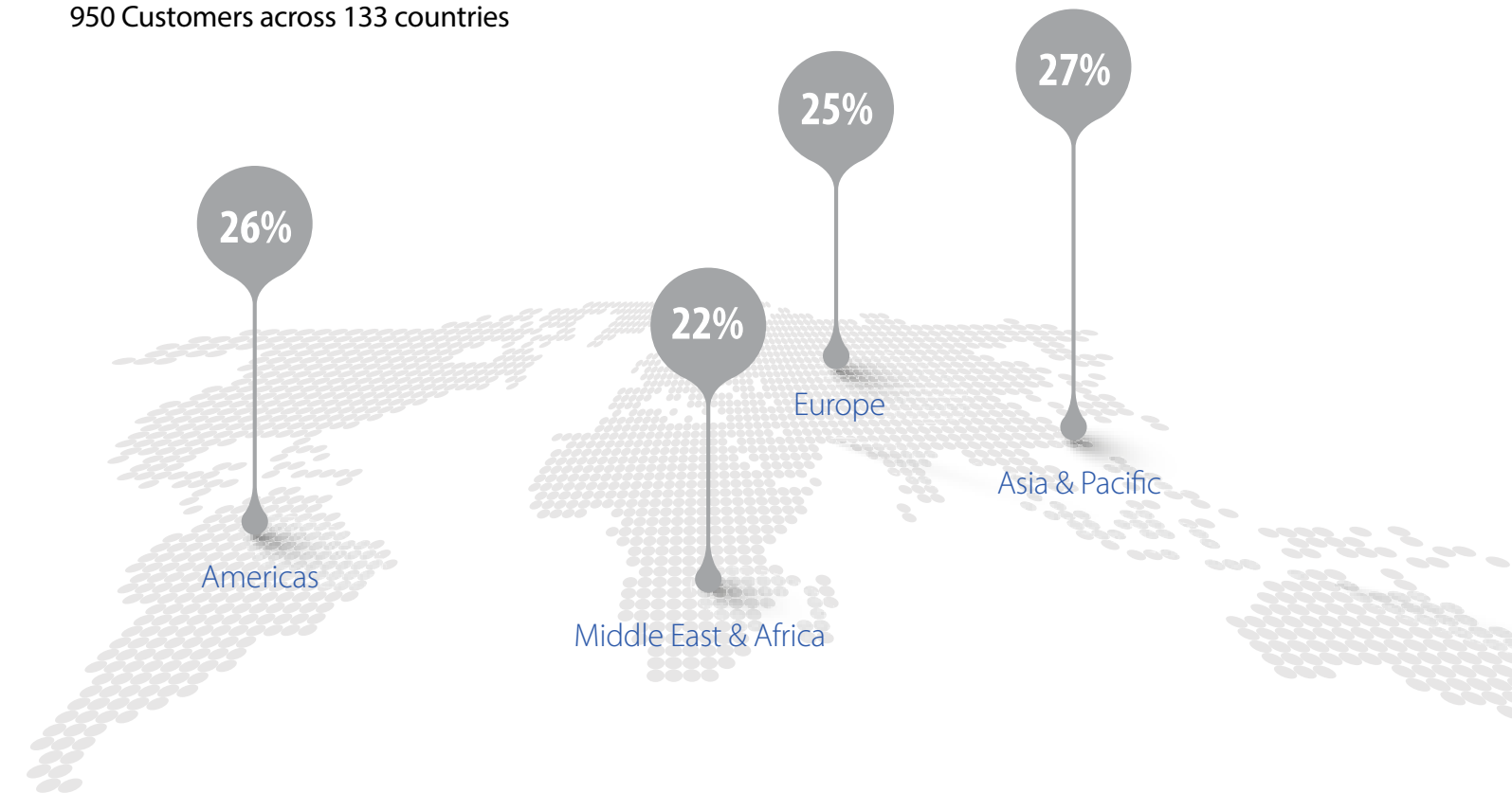

Business Growth



CAGR of **38%** (2006-2014)



Sales Network in **133** Countries



\$436,000,000
Market Capital (Dec, 2014)

Our Advantages



Technology

- . Word's best performing fingerprint algorithm
- . Industry-leading international awards and certifications



Quality

- . Manufactured by high quality IT production facilities in South Korea
- . Made from top quality components and materials



Partnership

- . Global partner program for training, technical support & upgrades
- . Structured sales policy through authorized distribution channel

Vertical Market



Manufacturing

- Kuwait National Petroleum Company, Kuwait
- Baltic Shipyard Factory, Estonia



Transportation

- Karachi Airport, Pakistan
- Dubai Airport, UAE
- Teheran Metro, Iran



Government

- Colombia National Police, Colombia
- Saudi Royal Council, Saudi Arabia



Commercial

- Panorama Tower, USA
- Daiso Japan, Japan
- Hotel Alma Pamplona, Spain



Health

- De Hoop ggz, Netherlands
- Argentina University Hospital, Argentina



Retail

- Carrefour, Turkey
- Tiffosi, Portugal
- ZARA, Venezuela



Banking & Finance

- Caixa Bank, Brazil
- Central Bank of the Philippines, Philippines



Education

- King Saud University, Saudi Arabia
- Istanbul University of Turkey, Turkey

Awards



Company Related Awards

Host	Details
A&S international Magazine	World's Top 50 Security Company
Frost & Sullivan	Biometrics Company of the Year
Deloitte	Technology Fast 500
Forbes Asia	200 Best Under a Billion



Product Related Awards

Host	Awards
Detektor International	Innovative Achievement Award - FaceStation, BioStation Best Product Award - BioLite Net
FVC	FVC, FVC Ongoing - Top Ranked
MINEX	NIST MINEX Test - Top Ranked
MIPS	MIPS Best Innovative Product Award - Access Control & Visitor Management
IFSEC International	IFSEC International AC Product of the Year Finalist - FaceStation, BioLite Net
ALL-OVER-IP	ALL-OVER-IP Best Product Award - BioEntry W



Company Related Certified

Certification	Type
ISO 14001 : 2004	Environmental Management
ISO 9001 : 2008	Quality Management