



suprema



suprema

# suprema Xpass

## Smart IP Access Reader

TCP/IP Ready

Wiegand/RS485 Interfaces

IP65 Waterproof

Power over Ethernet

## Contents

<b>Safety precautions</b>	3
<b>Product components</b>	5
<b>Optional accessories</b>	6
<b>Names of each parts</b>	7
<b>Product Dimension</b>	10
<b>Cables and Connectors</b>	11
<b>Power Connection</b>	14
<b>LAN Connection</b>	16
<b>RS485 Connection</b>	18
<b>Relay Connection</b>	20
<b>Digital Input Connection</b>	23
<b>Wiegand Input/Output</b>	25
<b>Output</b>	26
<b>Installation of Wall-mount Bracket</b>	27
<b>Installation Reference</b>	28
<b>Specification</b>	31
<b>Electrical Specification</b>	32
<b>FCC Rules</b>	33

## Safety precautions

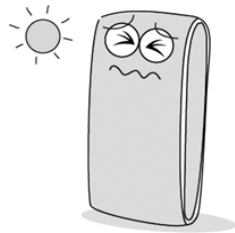

Do not install the device in a place subject to direct sun light, humidity, dust or soot.

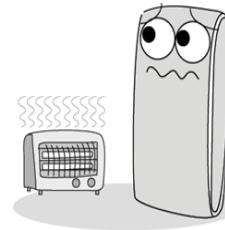

Do not place the device next to heating equipments.



Do not place a magnet near the product.

▶ It may cause a damage or a failure to the product.

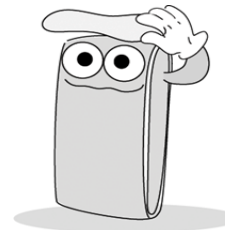

In cleaning, do not splash water on the device but wipe it out with smooth cloth or towel.

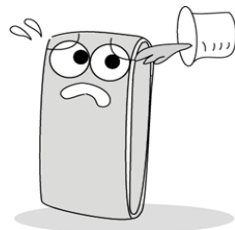

Be careful not to let liquid like water, drinks or chemicals leak inside the device.

▶ It may cause a failure.



Clean the device often to remove dust on it.

**The list below is to keep user's safety and prevent any loss. Please read safety precautions carefully before use.**

## Safety precautions



Do not drop the device.



Do not disassemble, repair or alter the device.

▶ The warranty does not apply to any product damage caused by an arbitrary installation or repair.



Do not let children touch the device without supervision.



Do not use the device for any other purpose than specified.



Do not damage the device.



Contact your nearest dealer in case of a trouble or problem.

**The list above is to keep user's safety and prevent any loss. Please read safety precautions carefully before use.**



## Product components

### Basic components



Xpass

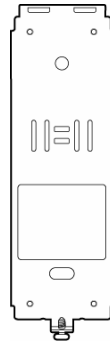

bracket

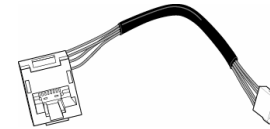

Extended Ethernet Cable



Wall mounting screws  
(2 ea)



Knife Blocks  
(2 ea)



Shrinkable Tubes

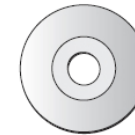

Software CD

 The components shown above may differ depending on the installation environment.



## Names of each parts

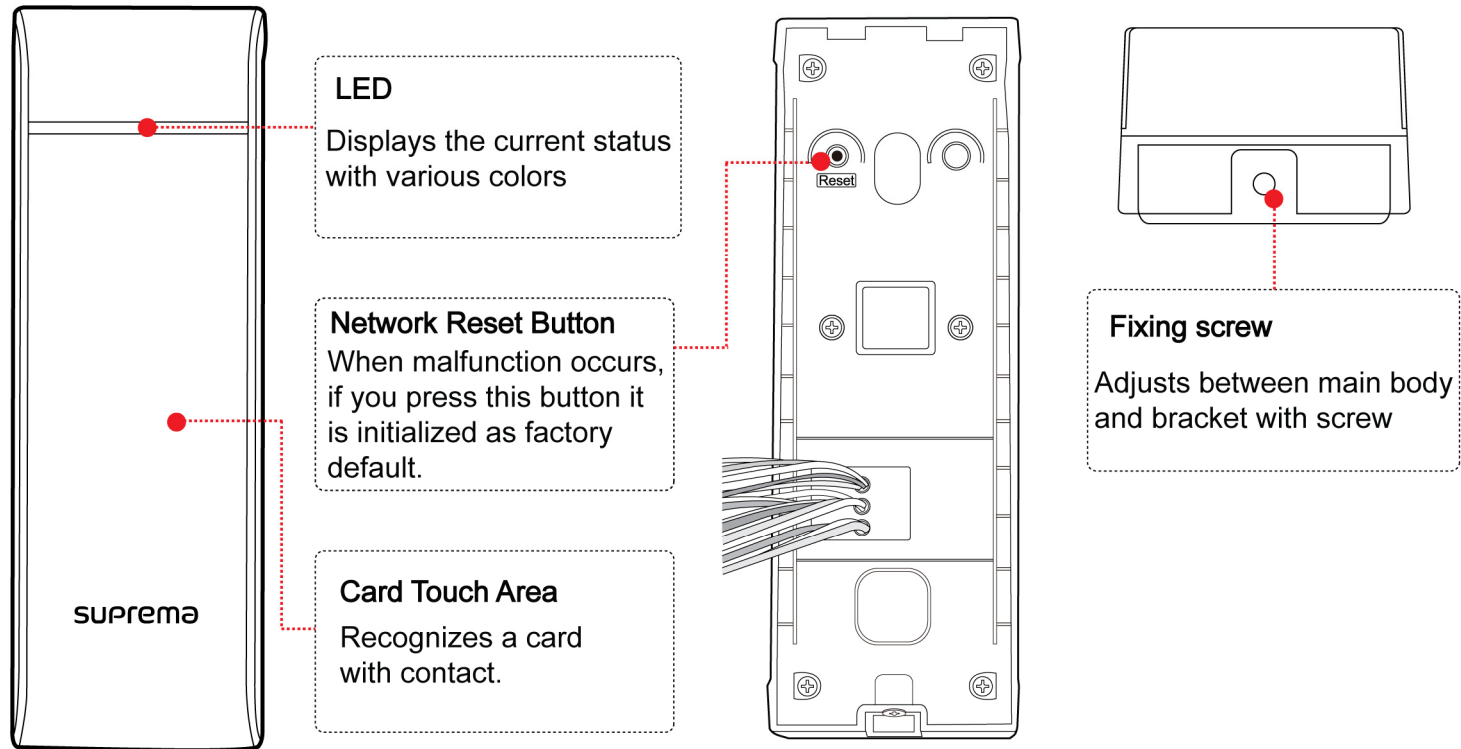

LED status

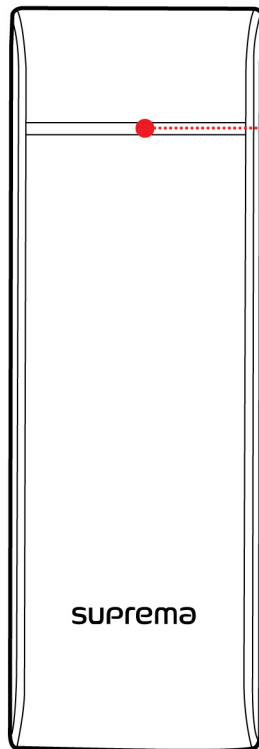

LED Status per Color		
Color	Sound	Description
Green	Beep Beep Beep	Authorization Success
Red	Be~ep	Authorization Fail
Pink	Beep!	On Processing
Flicker Blue/Sky-Blue Color per 2sec	No sound	Normal
Flicker Red/Pink Color per 2sec	No sound	Locked
Flicker Blue/Red Color per 2se	No sound	Initialized Time due to the Internal Battery Discharge
Flicker Blue /Yellow Color per 2sec	No sound	IP address is not assigned when terminal is set as 'Use' in the 'DHCP' of 'TCP/IP Setting'
For first operation, red LED is blinking by every 2 seconds.	No sound	Failed. Please contact to your distributor or Suprema
For normal operation, red LED is blinking by every 2 seconds.	No sound	Security status
Yellow LED is blinking shortly.	No sound	Terminal is send or received a packet to get IP address when terminal is set as 'Use' in the Idle status or 'TCP/IP Setting'



● Initialization of network setting

When you install the Xpass or forget the network setting's value of Xpass in use, can initial the network setting's value (TCP/IP address, RS-485 setting) in the switch of Xpass's back side as follows;

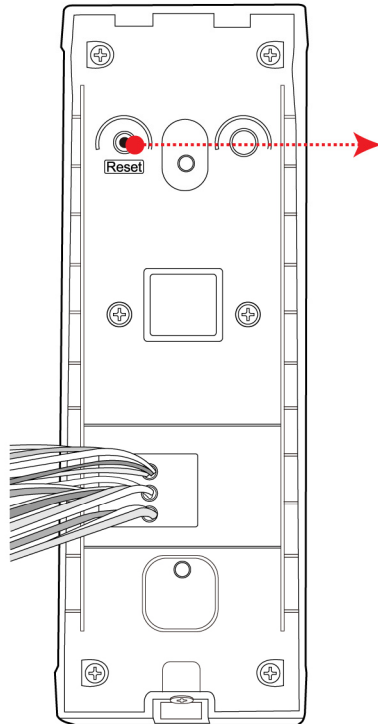

Initializing the network setting
<ol style="list-style-type: none"> <li>1. Press the Reset button in the switch of Xpass's back side for 3 second or above.</li> <li>2. Connect between Xpass and Biostar Client(Ver.1.25 or higher) by using TCP/IP or RS-485.                             <ul style="list-style-type: none"> <li>·Network default setting value</li> <li>- TCP/IP Address(Fixed): 192.168.0 bps(Not Checked: Use Server)</li> <li>- RS-485 : PC Connection, 115200 bps</li> </ul> </li> <li>3. Enter th desired value of TCP/IP address or RS-485 to change setting value. And save setting value.</li> <li>4. After delete the Xpass among devices list, re-connect bewteen Xpass and BioStar using the new TCP/IP address or RS-485 setting.</li> </ol>

## Product Dimension

(unit : mm)

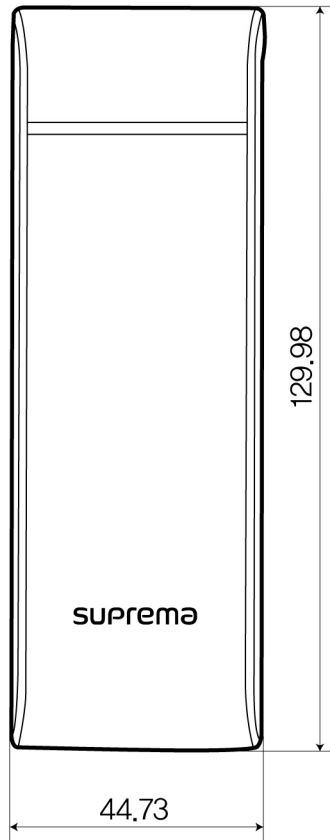

< Front View >

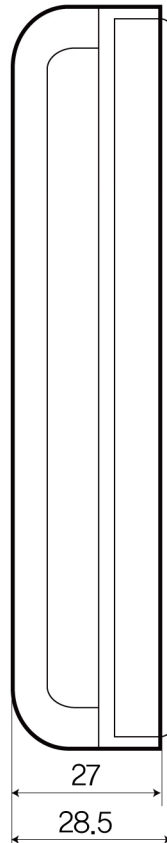

< Side View >

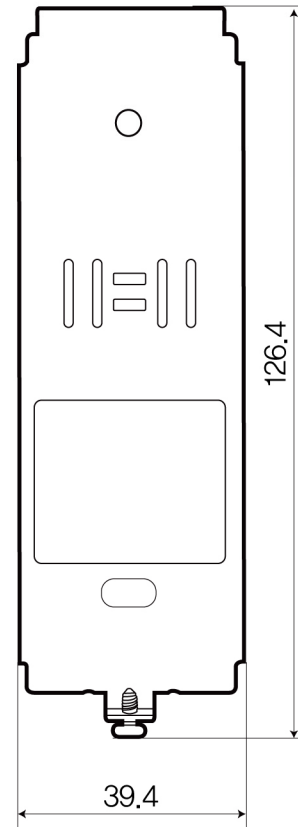

< Bracket >

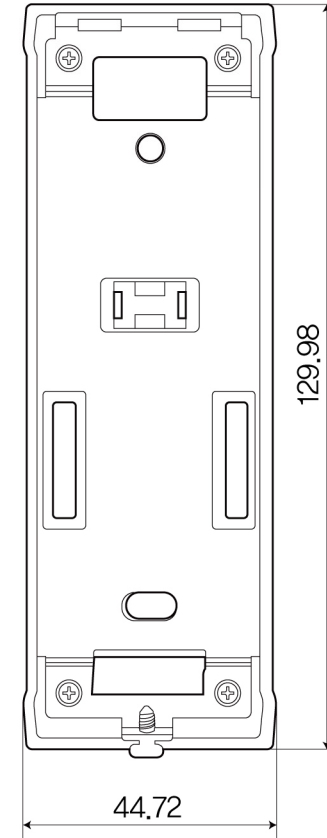

< Extended bracket >

## Cables and Connectors

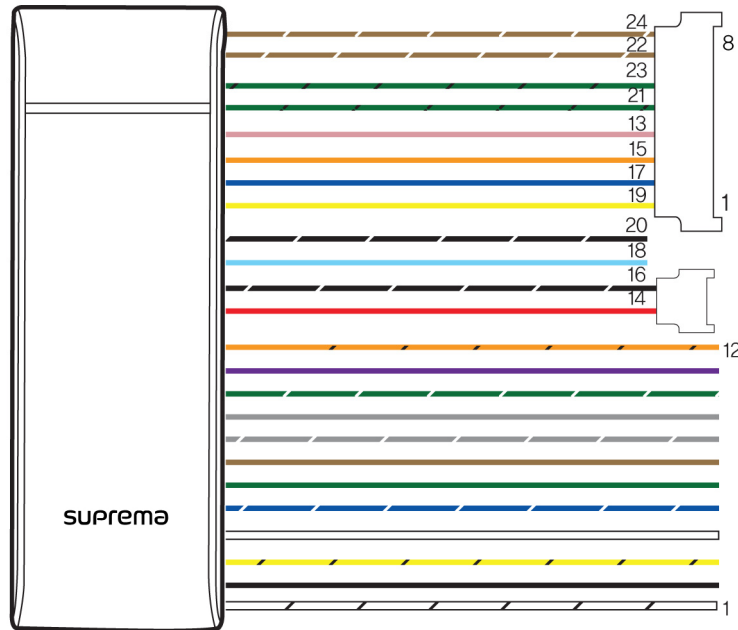

A Cross Section of Cable

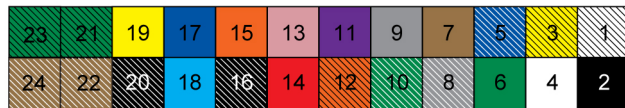

No	Pin Name	Full Name	Color
1	485 GND	485 GND	White (black string)
2	WGD GND	Wiegand-GND	Black
3	485 -	485 -	Yellow (black string)
4	WGD D1	Wiegand-1	White
5	485 +	485 +	Blue (white string)
6	WGD D0	Wiegand-0	Green
7	IN 1	Input-1	Brown
8	RLY NO	Relay Open	Gray (white string)
9	IN GND	Input-GND	Gray
10	RLY COM	Relay Com	Green (white string)
11	IN 0	Input-0	Purple
12	RLY NC	Relay Close	Orange (black string)
13	TX+	TX+ (LAN)	Pink
14	PWR IN+	Power IN+	Red
15	TX-	TX- (LAN)	Orange
16	PWR IN-	Power IN-	Black (white string)
17	RX+	RX+ (LAN)	Blue
18	PWR OUT+	Power OUT+	Light Blue
19	RX-	RX- (LAN)	Yellow
20	PWR OUT-	Power OUT-	Black (white string)
21	VB1	VB1	Green (black string)
22	VB2	VB2	Brown (white string)
23	VB1	VB1	Green (black string)
24	VB2	VB2	Brown (white string)

## Cables and Connectors

### ● Cable Specification

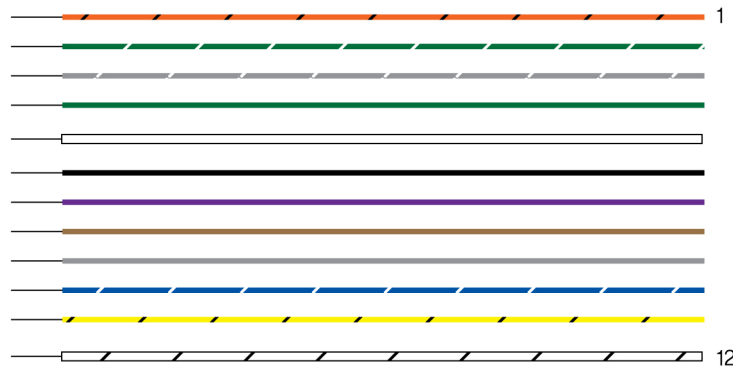

Cable	Pin Name	Color
1	RLY NC	Orange (black string)
2	RLY COM	Green (white string)
3	RLY NO	Gray (white string)
4	WGD D0	Green
5	WGD D1	White
6	WGD GND	Black
7	IN 0	Purple
8	IN 1	Brown
9	IN GND	Gray
10	485+	Blue (white string)
11	485-	Yellow (black string)
12	485 GND	White (black string)



Adaptor Connector	Pin Name	Color
	POWER OUT -	Black (white string)
	POWER OUT +	Light Blue
3	POWER IN -	Black (white string)
1	POWER IN +	Red

LAN cable

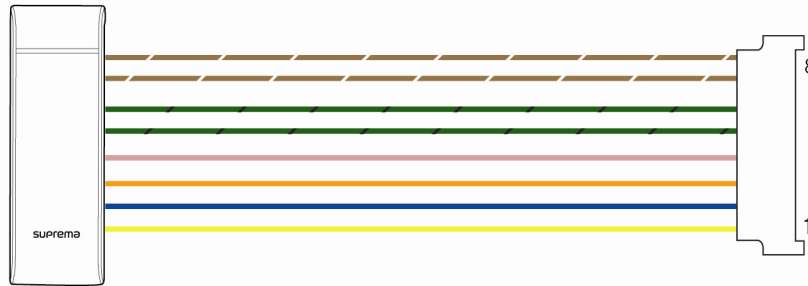

LAN Connector	Pin Name	Color
1	RX-	Yellow
2	RX+	Blue
3	TX-	Orange
4	TX+	Pink
5	VB1	Green (black string)
6	VB1	Green (black string)
7	VB2	Brown (white string)
8	VB2	Brown (white string)

Ethernet extension cable

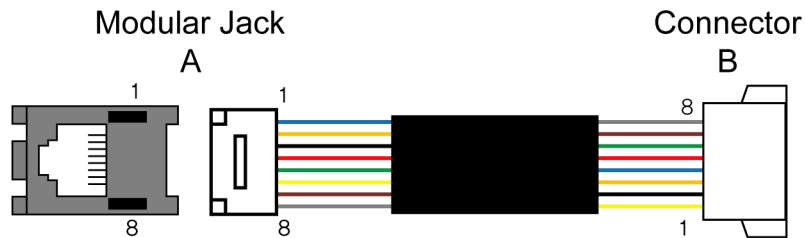

Modular Jack (A)	Connector (B)	Pin Name	Color
1	4	TX+	Blue
2	3	TX-	Orange
3	2	RX+	Black
6	1	RX-	Yellow
4	5	VB1	Red
5	6	VB1	Green
7	7	VB2	Brown
8	8	VB2	Gray



## Power Connection 1

Pin	Pin Name	Color
14	PWR IN+	Red
16	PWR IN-	Black (white string)

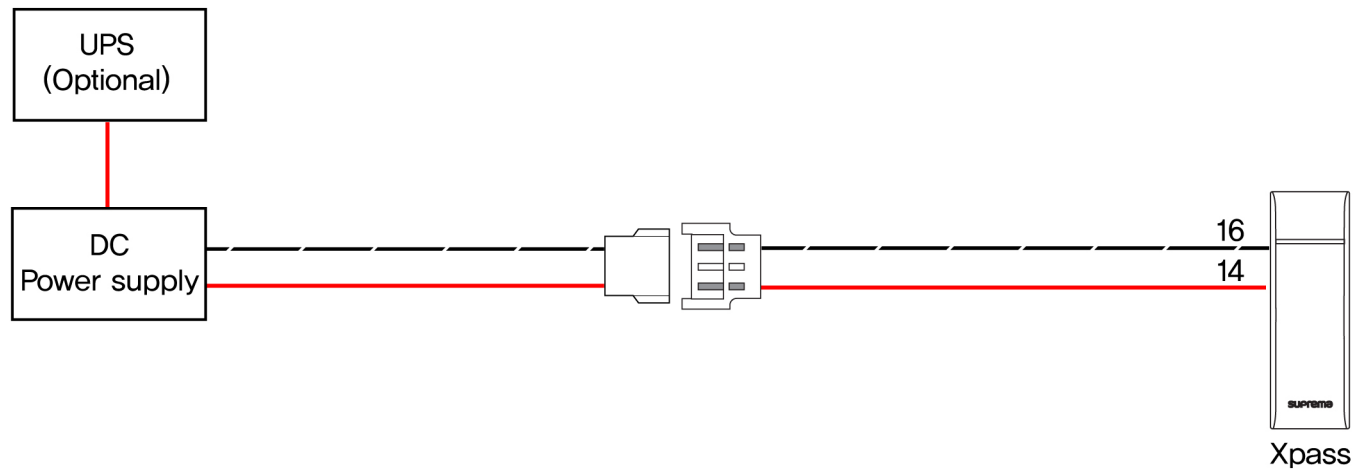

### Recommended power supply

12V  $\pm$  10%, at least 500mA.

Comply with standard IEC/EN 60950-1.

To share the power with other devices, use a power supply with higher current ratings.

## Power Connection 2

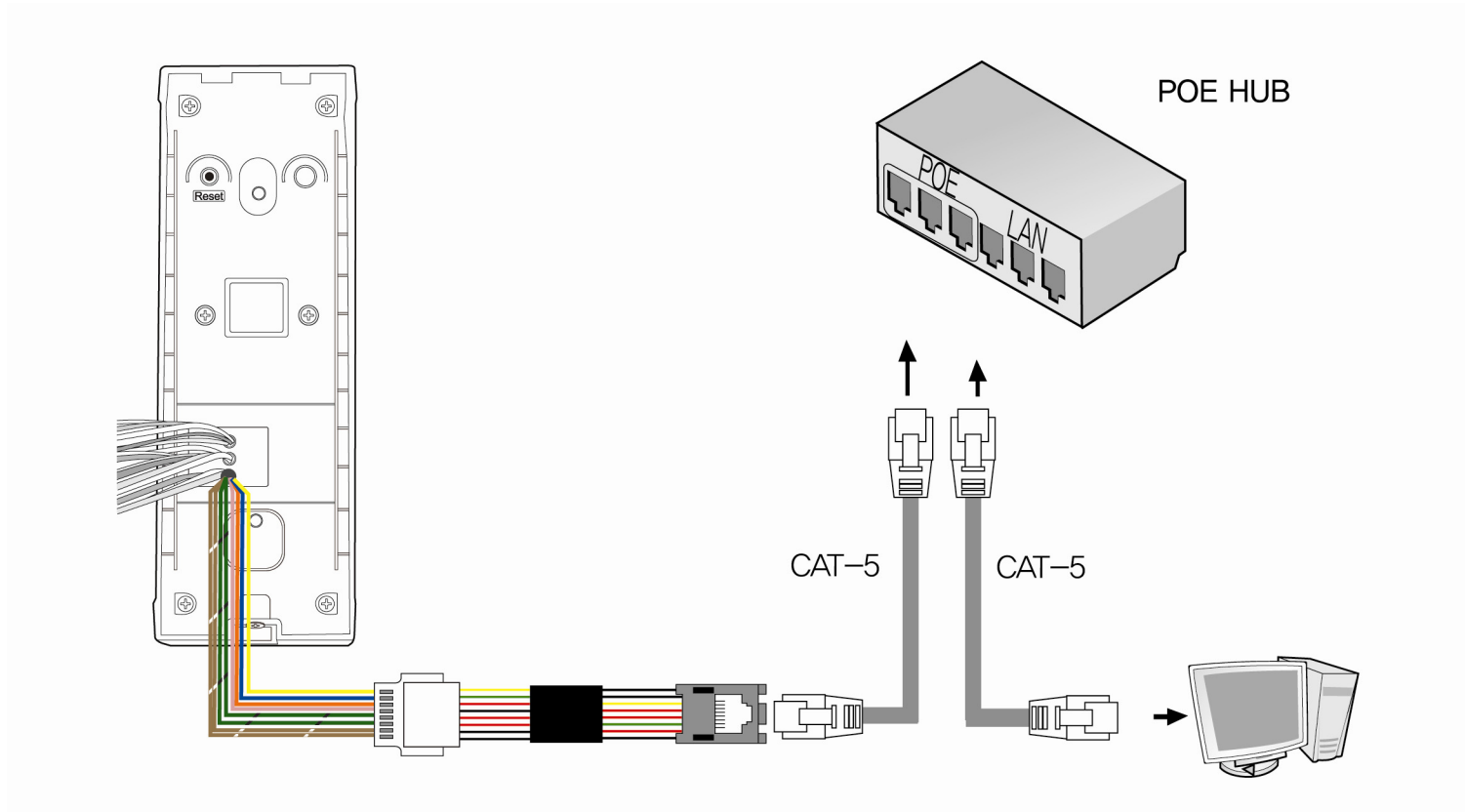

### Recommended power supply

Please use the distance of LAN cable within 100m in case of POE power.

## LAN Connection

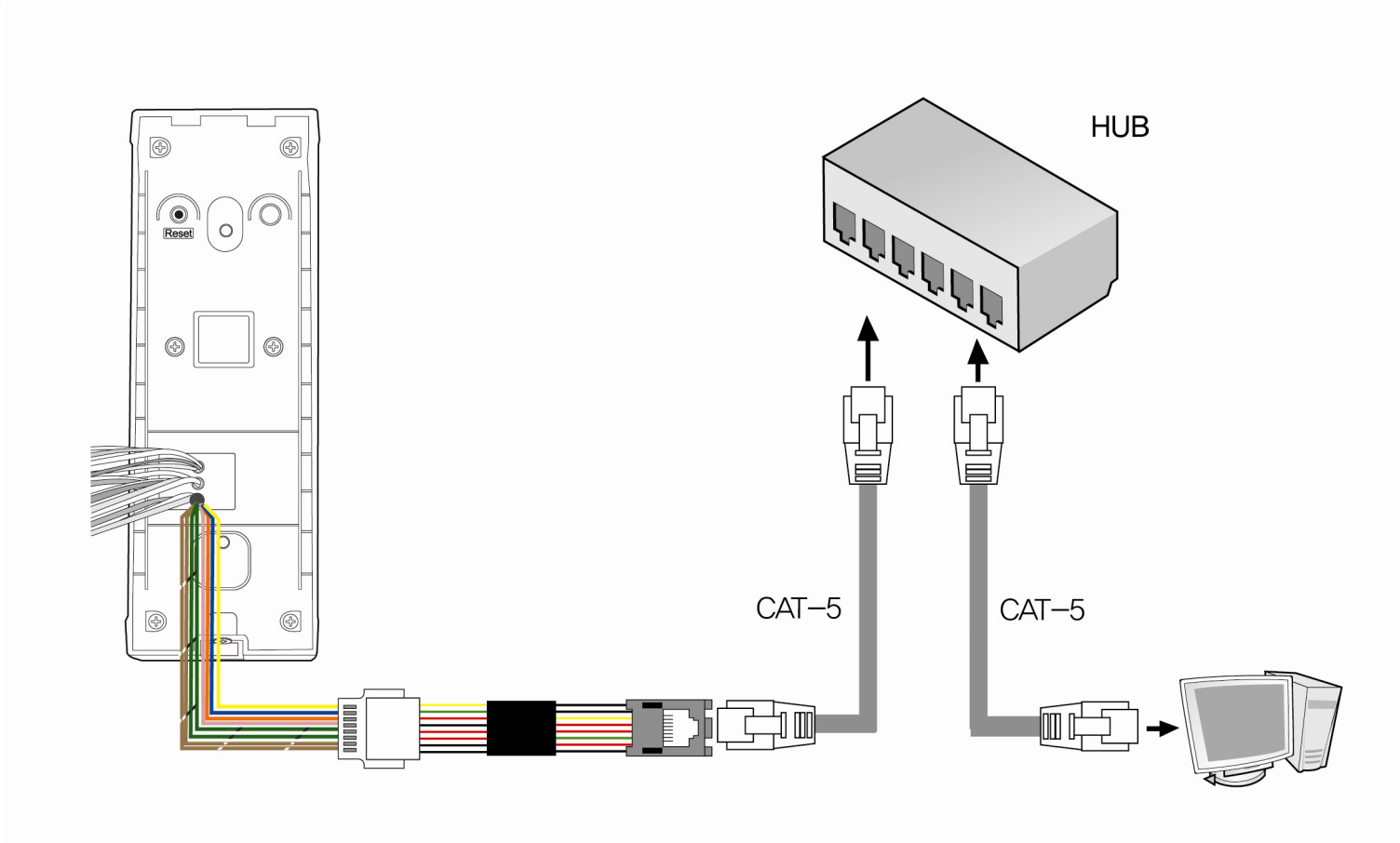

## LAN Connection (Direct connection with PC)

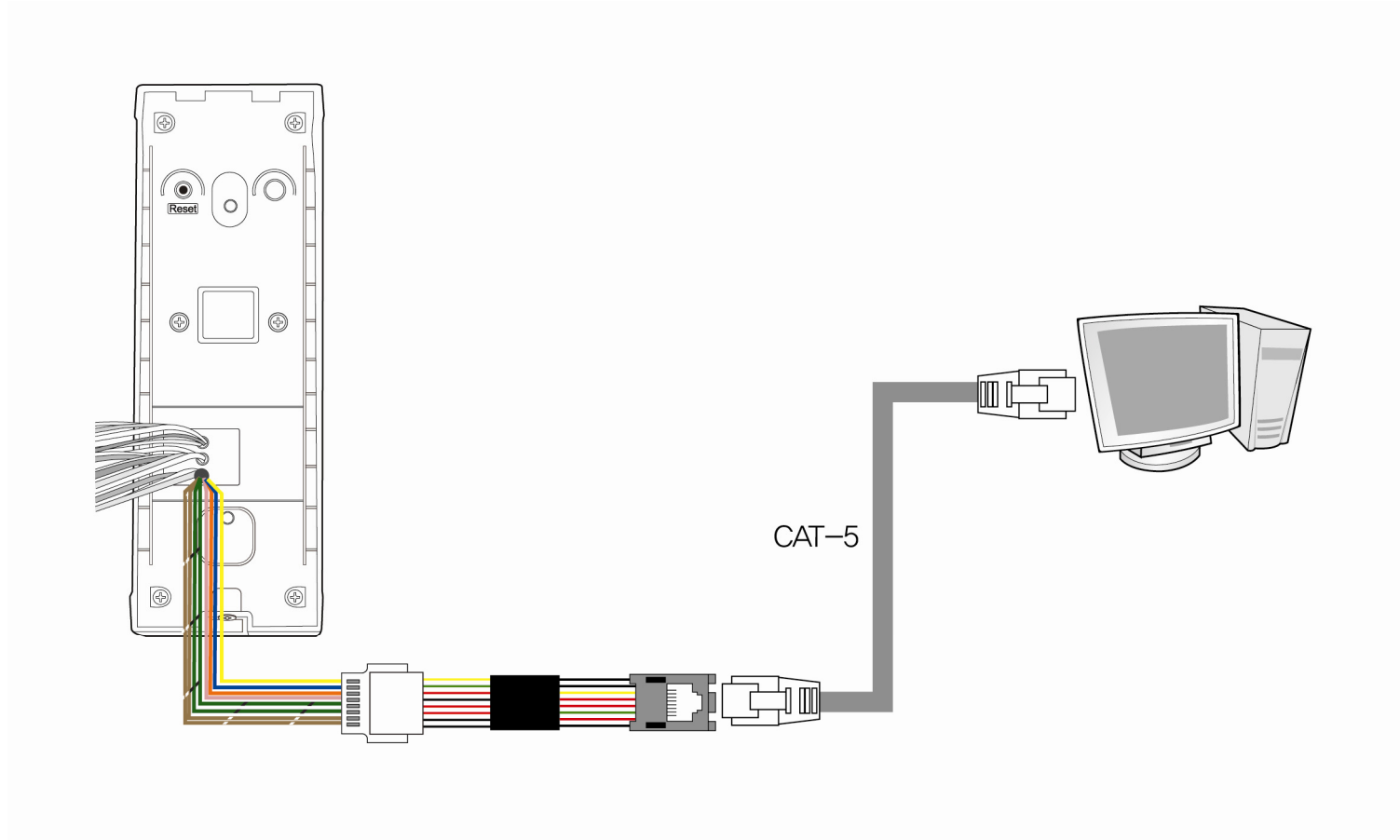

## RS485 Connection for Host Communication

Pin	Pin Name	Color
1	485 GND	White (black string)
3	485 -	Yellow (black string)
5	485 +	Blue (white string)

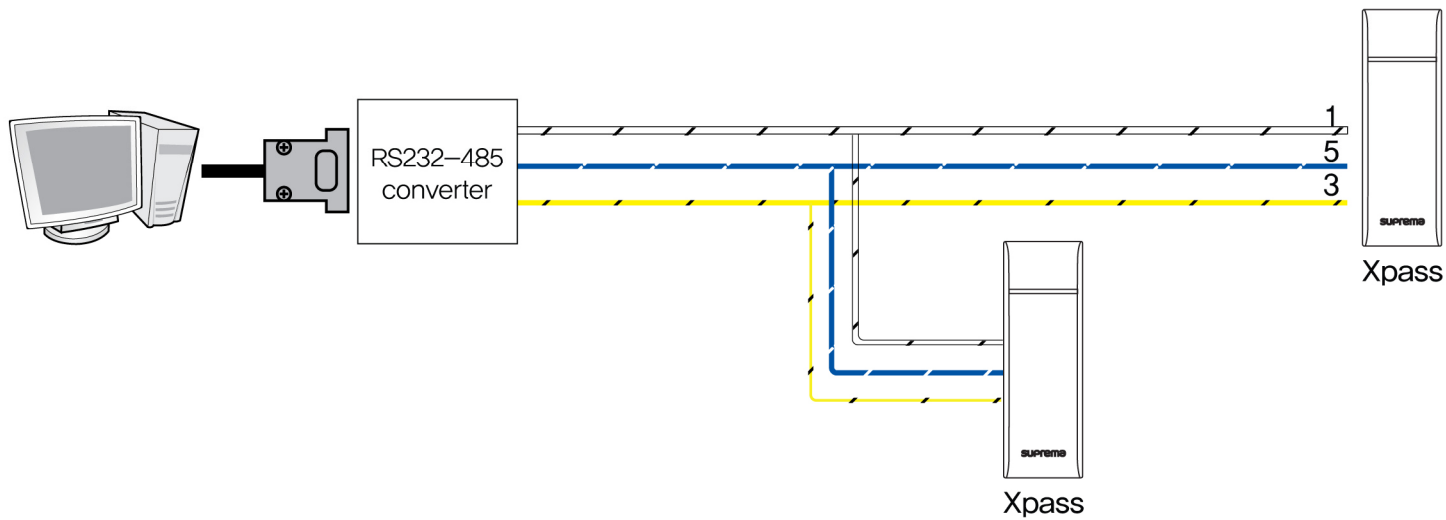



## RS485 Connection for Secure I/O

Pin	Pin Name	Color
1	485 GND	White (black string)
3	485 -	Yellow (black string)
5	485 +	Blue (white string)

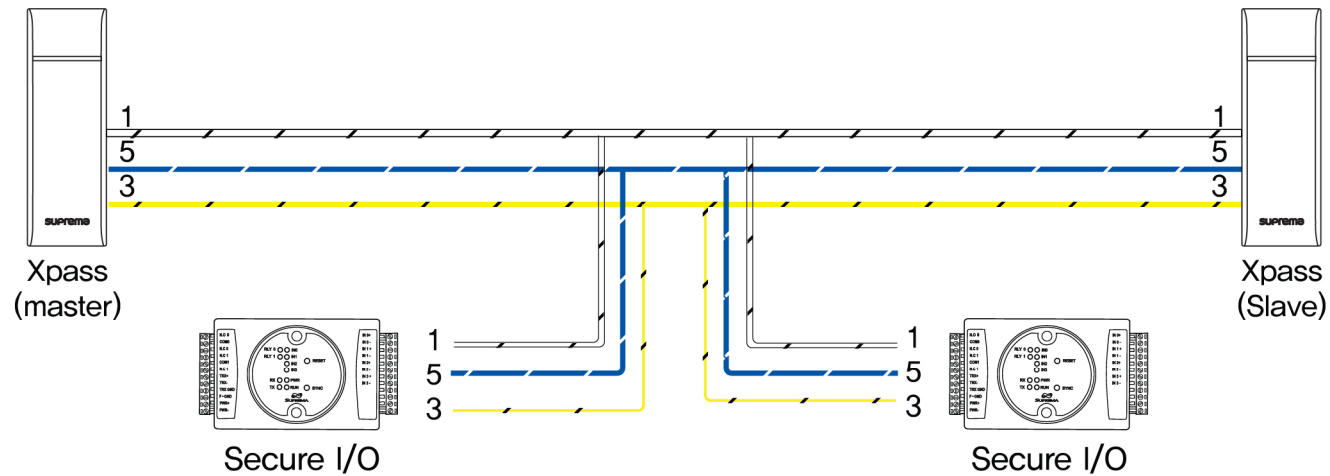

### Max number of devices

Maximum eight(8) devices (including Master) interworks in an RS485 loop.

## Relay Connection – Fail safe lock

Pin	Pin Name	Color
10	RLY COM	Green (white string)
12	RLY NC	Orange (black string)

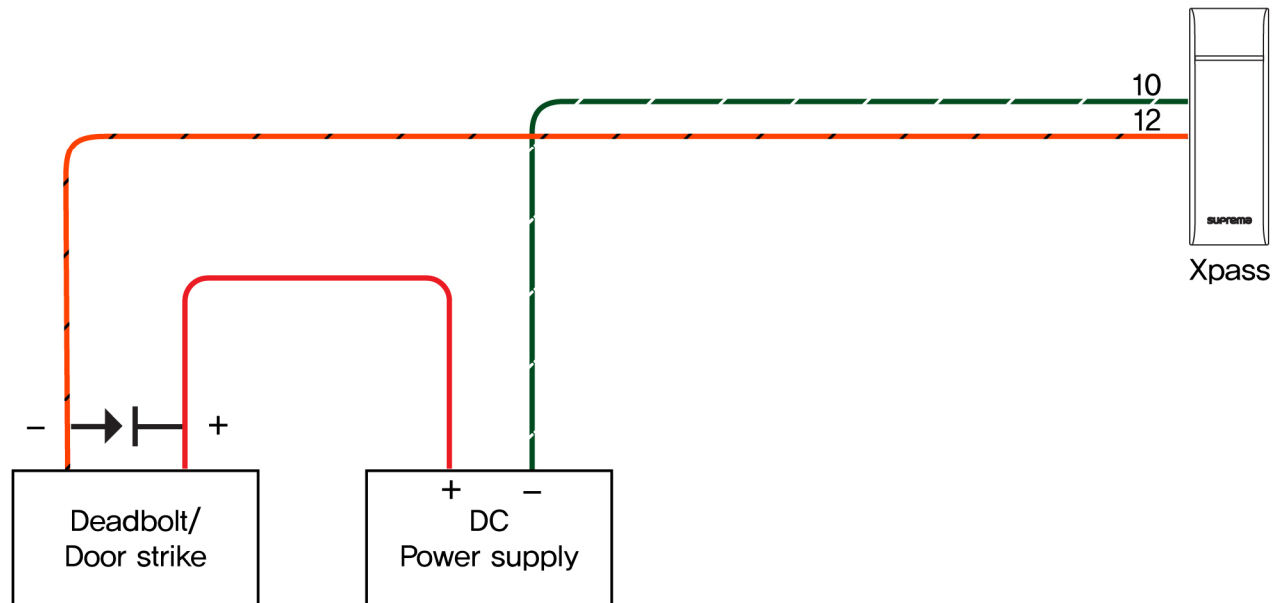

## Relay Connection – Fail secure lock

Pin	Pin Name	Color
8	RLY NO	Gray (white string)
10	RLY COM	Green (white string)

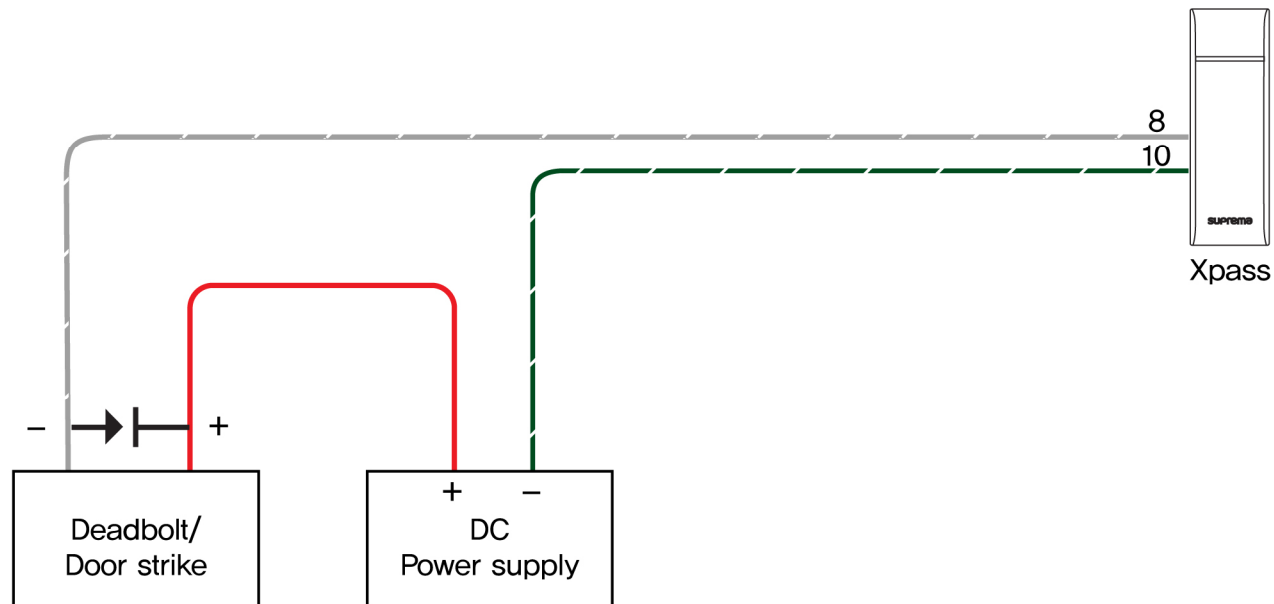

## Relay Connection - Automatic door

Pin	Pin Name	Color
8	RLY NO	Gray (white string)
10	RLY COM	Green (white string)

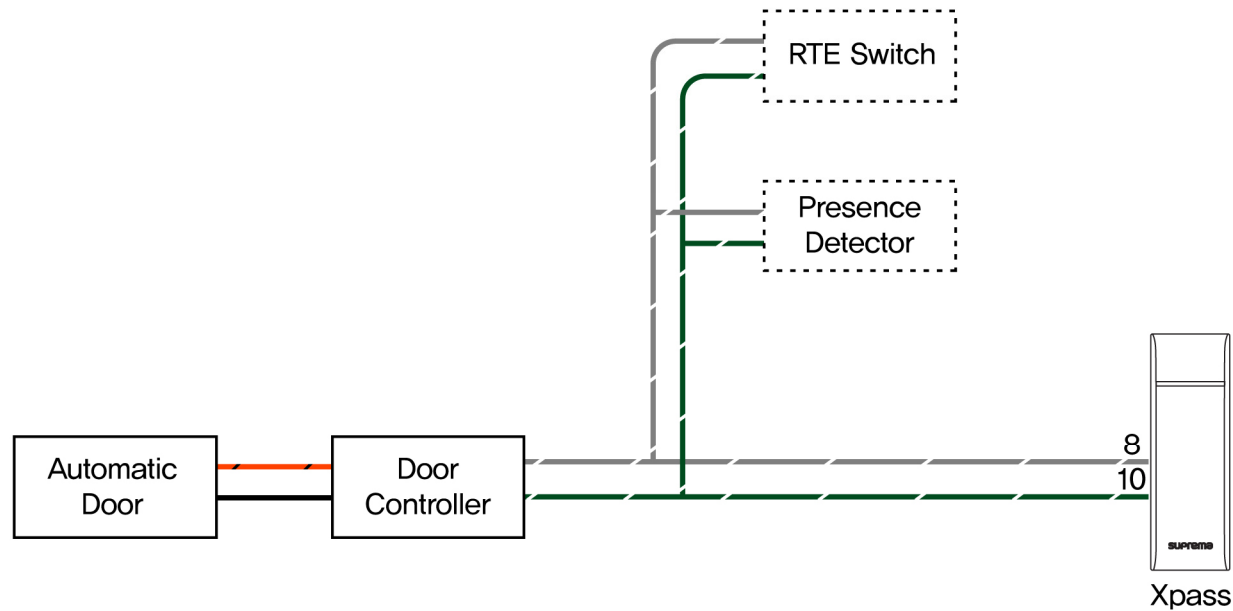

## Digital Input Connection (Alarm, Emergency S/W)

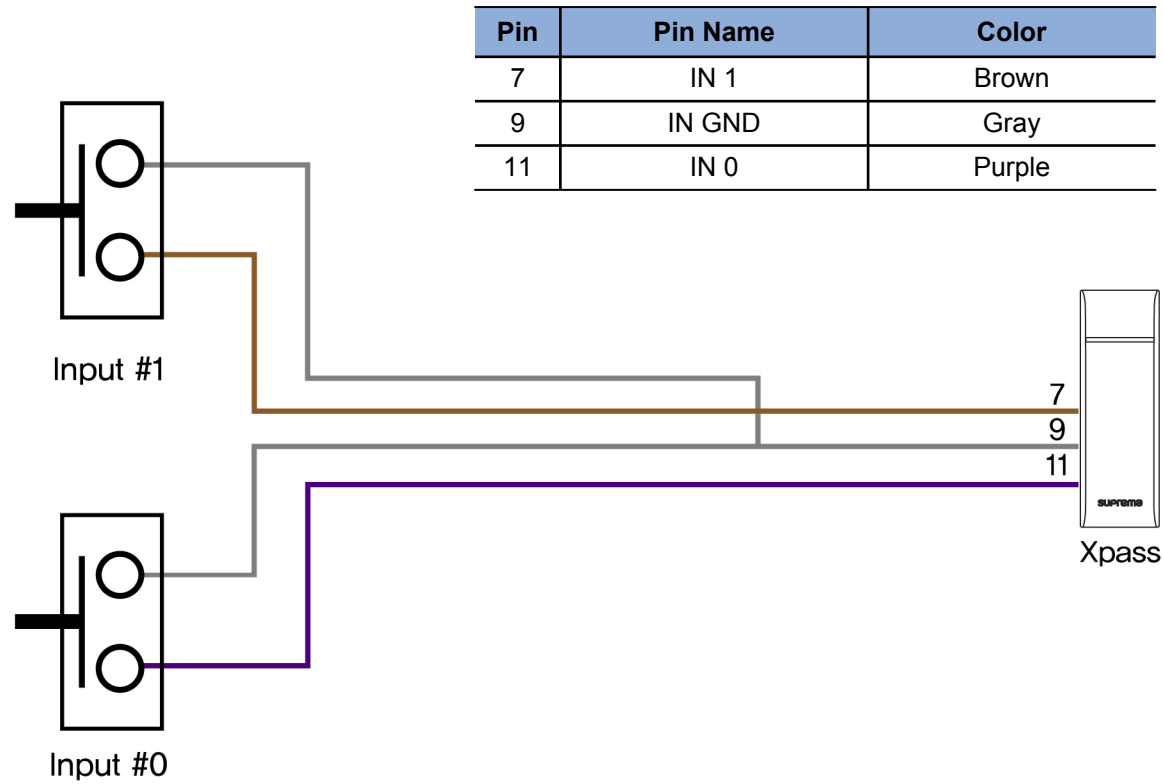



## Digital Input Connection (RTE, Door sensor)

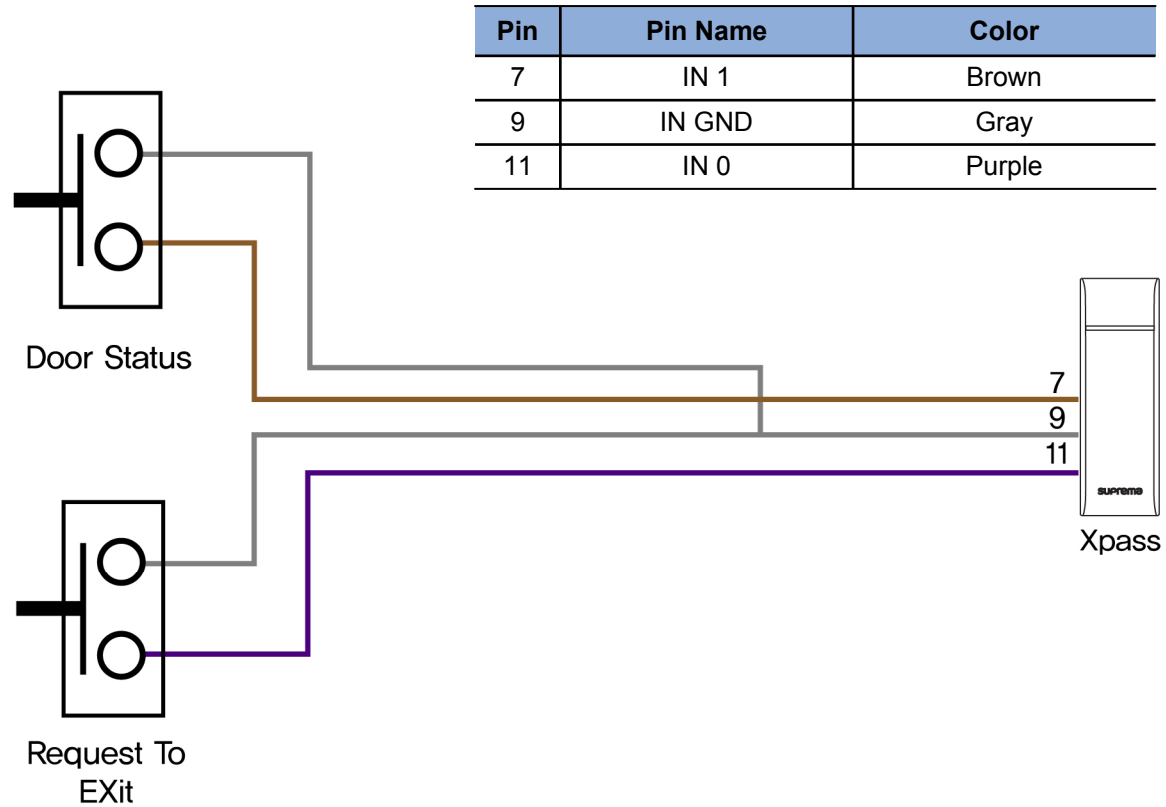

## Wiegand Input/Output

### Wiegand Input

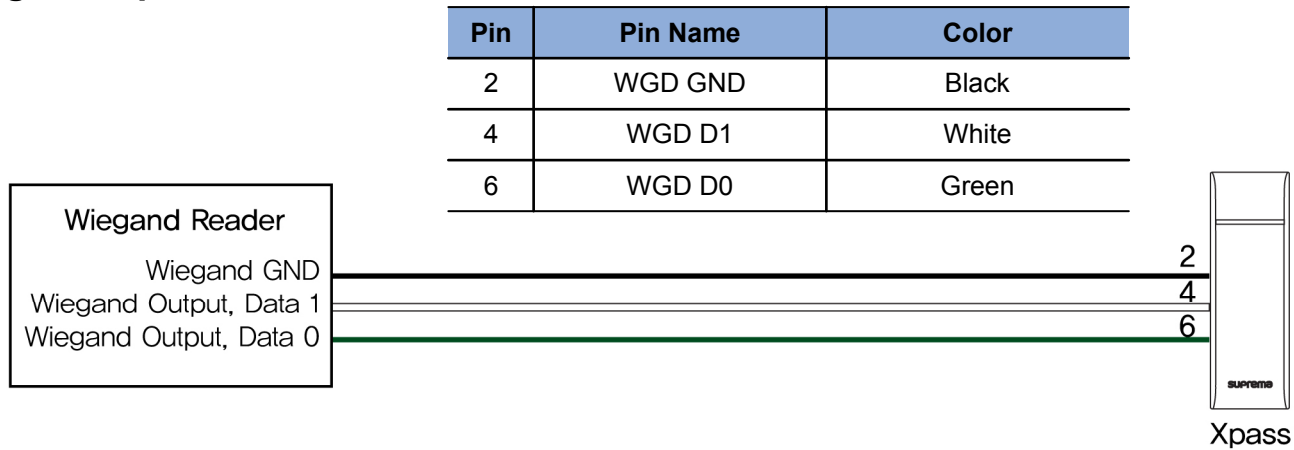

### Wiegand Output

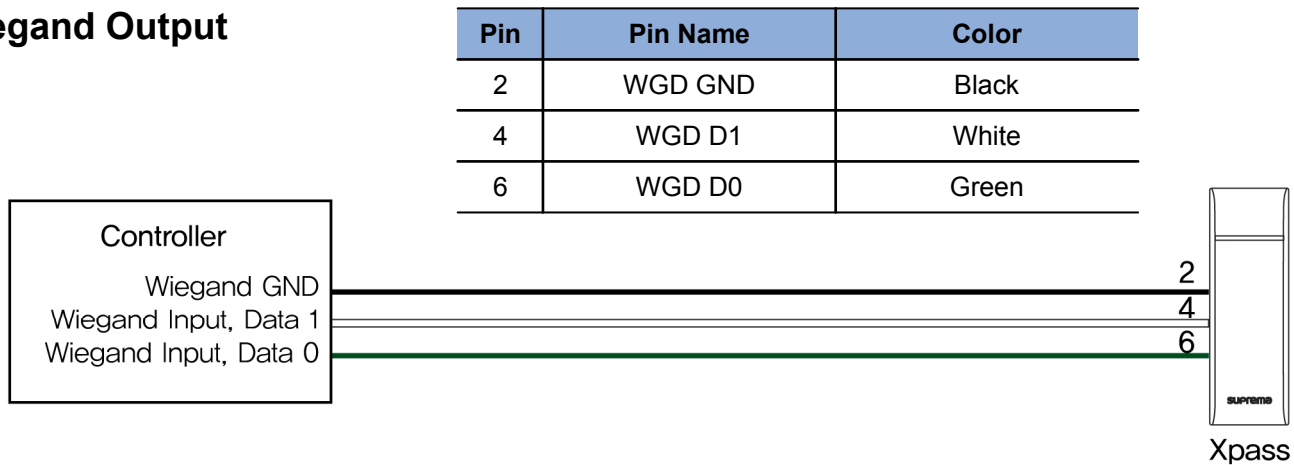

## Output

Pin	Pin Name	Color
10	RLY COM	Green (white string)
12	RLY NC	Orange (black string)
18	PWR OUT +	Light Blue
20	PWR OUT -	Black (white string)

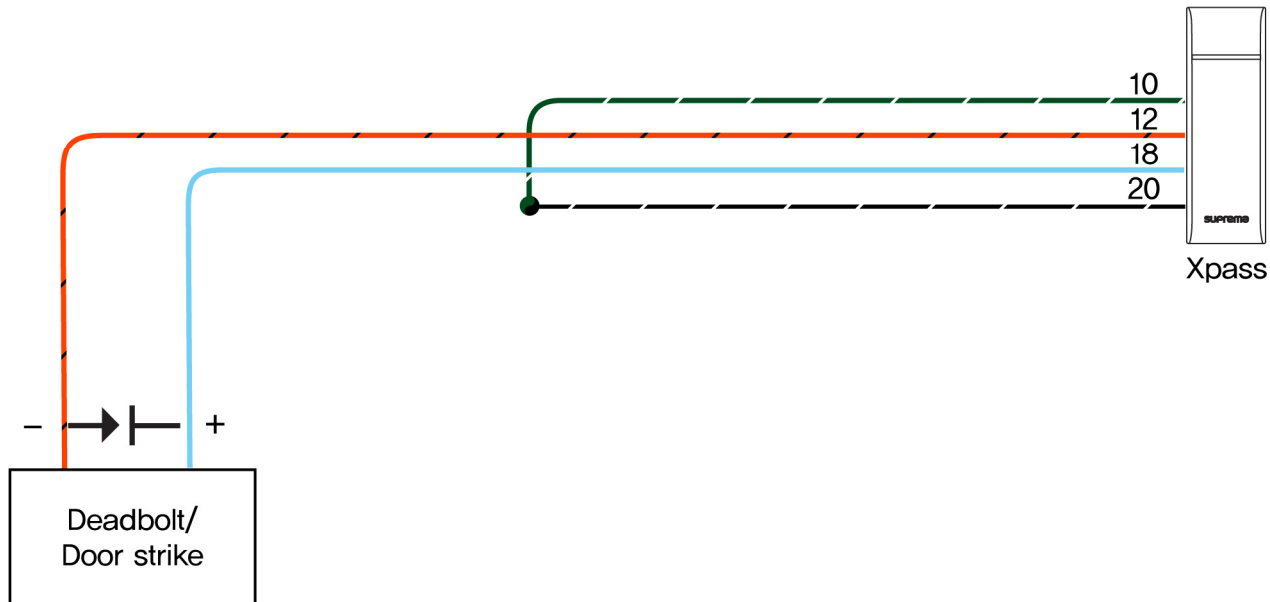

**Caution :** Max. 700mA is supplied using adapter for the external output.  
**Be careful to satisfy the power capacity in use.**

## Installation of Wall-mount Bracket

- Fix wall mount bracket on a wall using wall mounting screws

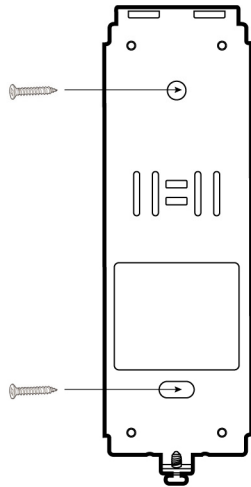

- Hook Xpass on the wall mount bracket

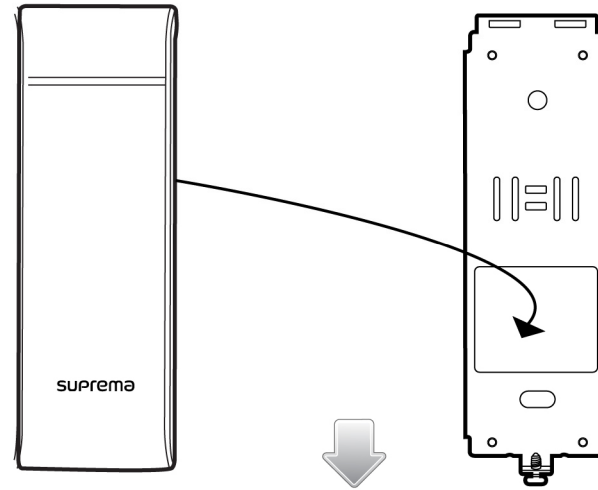

- Fix Xpass and wall mounting bracket using a wall mounting screw.

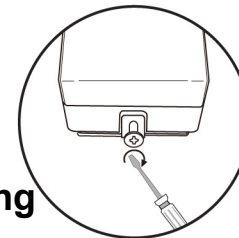

## Installation Reference 1 - Stand alone

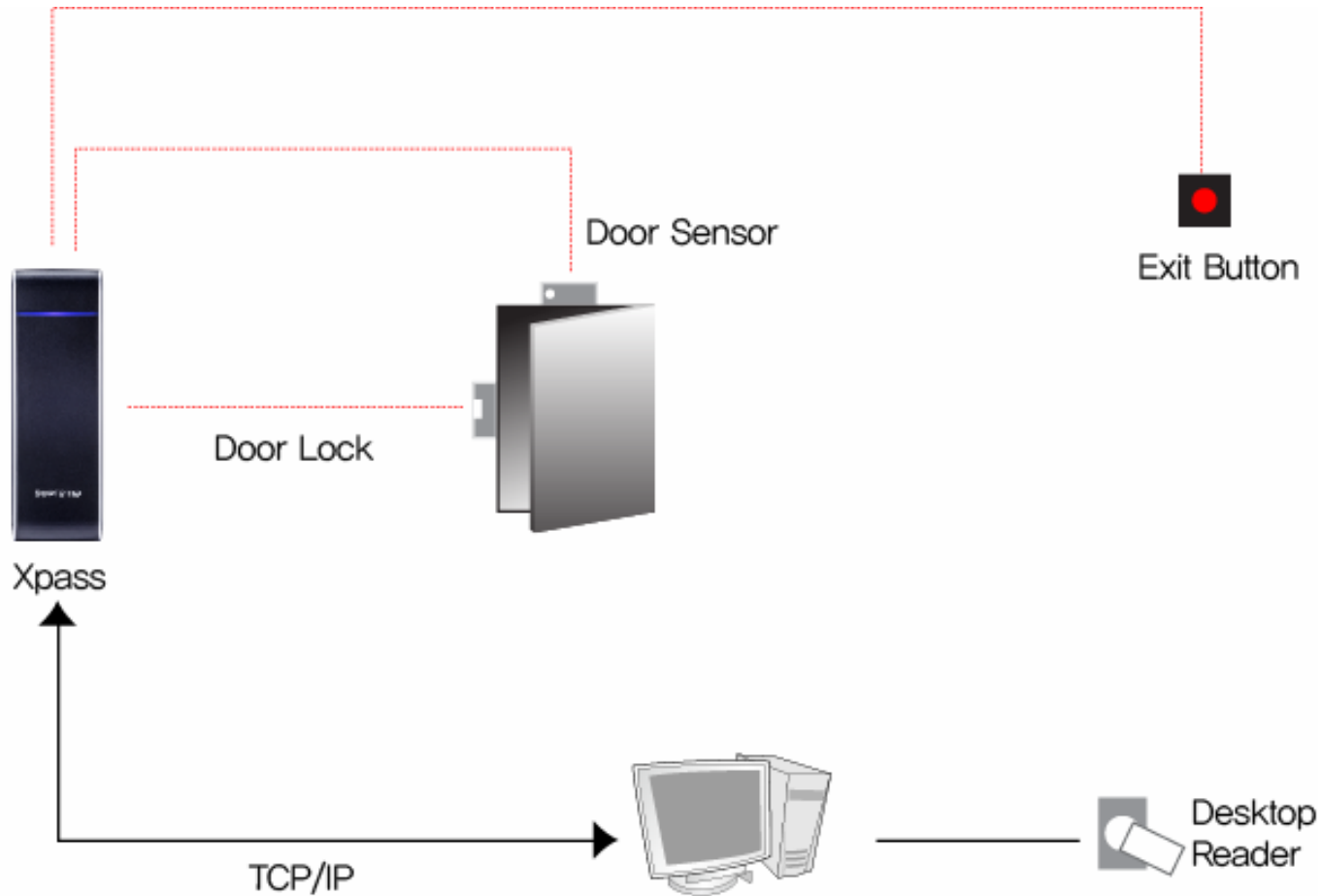

## Installation Reference 2 – Standalone (Secure)

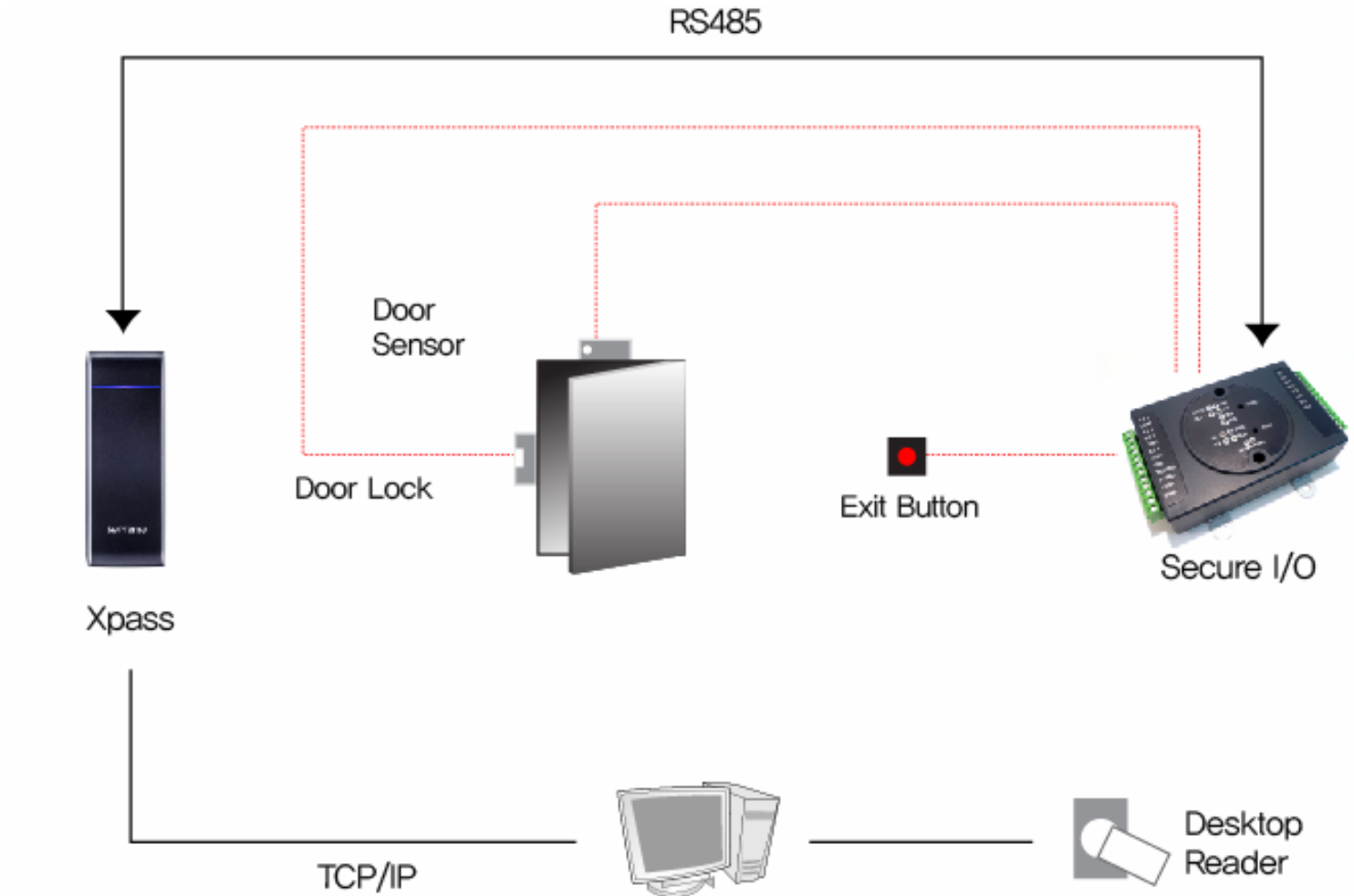

## Installation Reference 3 – Network

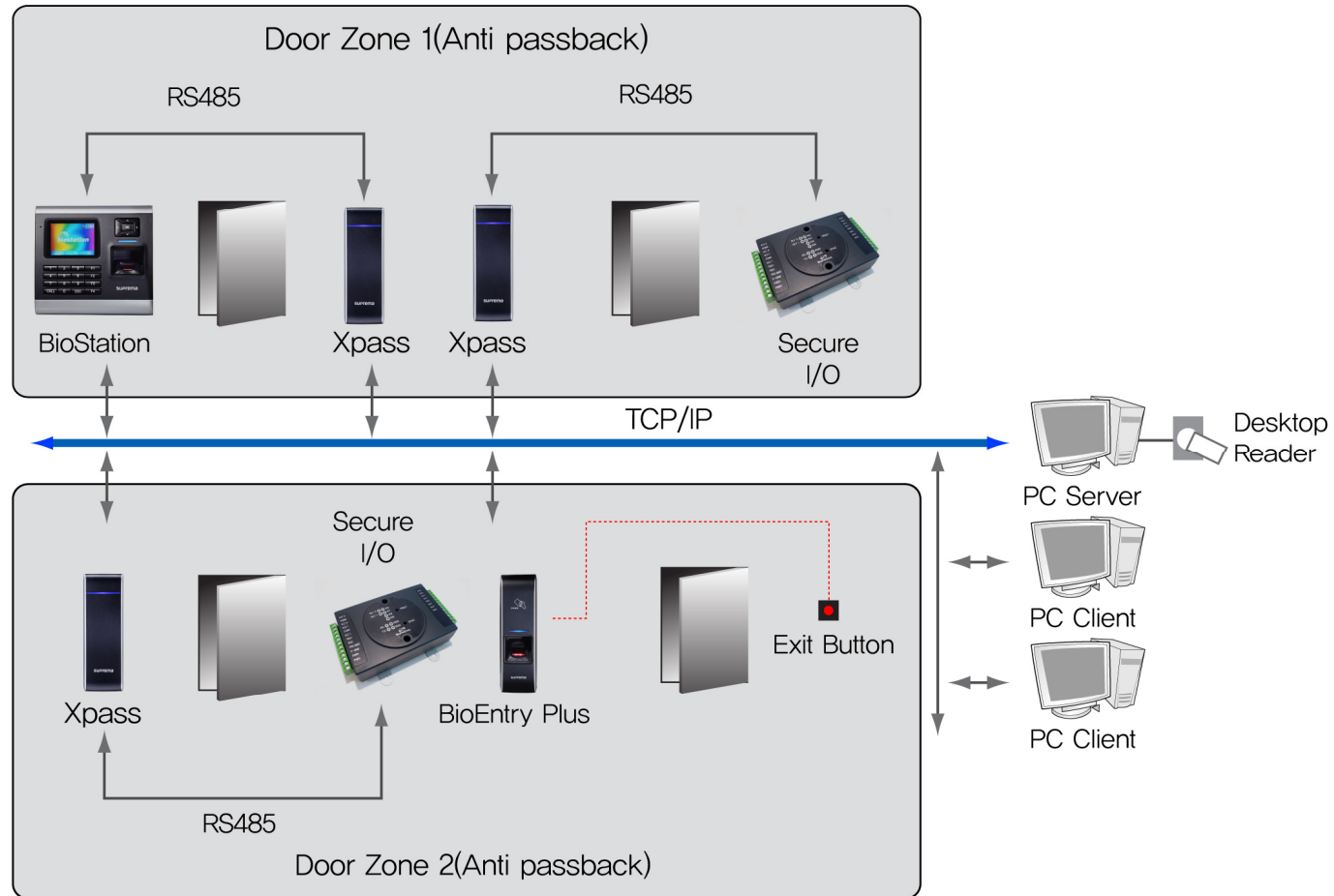



## Specification

<b>CPU</b>	32 bit Micro-processor
<b>Memory</b>	8MB FLASH + 16MB SDRAM
<b>RF Card</b>	13.56 MHz Mifare (XPM) 125 KHz EM Prox (XPE) 125 KHz HID Prox (XPH)
<b>User Capacity</b>	40000 user
<b>Log Capacity</b>	50000 log
<b>Network interfaces</b>	TCP/IP, RS485
<b>IP Rate</b>	IP 65 class
<b>Sound</b>	Multi-tone buzzer
<b>LED</b>	Multi-color LED
<b>RTC</b>	Lithium-ion rechargeable batteries
<b>I/O</b>	Relay x 1 Tamper x 1 Switch input x 2 Wiegand x 1
<b>Power</b>	12Vdc, POE
<b>Operating Temperature</b>	-20 ~ 50° C
<b>Size</b>	45 x 130 x 27mm (W x H x D )
<b>Certificates</b>	CE, FCC, KCC, IP65



### Caution for RTC Battery

It may be occurred the risk of explosion for improper replacement of battery.  
Please use the specified battery according to proper instruction.

## Electrical Specification

	Min.	Typ.	Max.	Notes
<b>Power</b>				
Voltage (V)	10.8	12	13.2	Use regulated DC power adaptor only
Current (mA)	-		140	
<b>Switch Input</b>				
VIH (V)	-	TBD	-	
VIL (V)	-	TBD		
Pull-up resistance ( $\Omega$ )	-	4.7k	-	The input ports are pulled up with 4.7k resistors
<b>TTL/Wiegand Output</b>				
VOH (V)	-	5	-	
VOL (V)	-	0.8	-	
Pull-up resistance ( $\Omega$ )	-	4.7k	-	The outputs ports are open drain type, pulled up with 4.7k resistors internally
<b>Relay</b>				
Switching capacity (A)	-	-	1 0.3	30V DC 125V AC
Switching power (resistive)	-	-	30W 37.5V A	DC AC
Switching voltage (V)	-	-	110 125	DC AC

## FCC Rules

### Caution

Changes or modifications not expressly approved by the manufacturer responsible for compliance could void the user's authority to operate the equipment.

### Warning

This device complies with part 15 of the FCC Rules. Operation is subject to the following two conditions: (1) This device may not cause harmful interface, and (2) this device must accept any interface received, including interference that may cause undesired operation.

### Information to User

This equipment has been tested and found to comply with the limit of a Class B digital device, pursuant to Part 15 of the FCC Rules. These limits are designed to provide reasonable protection against harmful interference in a residential installation. This equipment generates, user and can radiate radio frequency energy and, if not installed and used in accordance with the instructions, may cause harmful interference to radio communications.

However, there is no guarantee that interference will not occur in a particular installation; if this equipment does cause harmful interference to radio or television reception, which can be determined by turning the equipment off and on, the user is encouraged to try to correct the interference by one or more the following measures:

1. Reorient / Relocate the receiving antenna.
2. Increase the separation between the equipment and receiver.
3. Connect the equipment into an outlet on a circuit difference from that to which the receiver is connected.
4. Consult the dealer or an experienced radio/TV technician for help



Suprema Inc.  
16F Parkview Office Tower, Jeongja-dong, Bundang-gu,  
Seongnam, Gyeonggi, 463-863 Korea  
E-mail : [support@supremainc.com](mailto:support@supremainc.com)  
Website : [www.supremainc.com](http://www.supremainc.com)

Functions and specifications of the product are subject to changes without notice due to quality enhancement or function update. For any inquiry on the product, please contact Suprema Inc.