

BioEntry™ Pass

Fingerprint Access Reader



- Simple one-touch operation - no more keys, cards, or PINs
- Industry's fastest identification - 1 to 1000 search in 1 second
- Award winning fingerprint recognition engine (No.1 in FVC2004)
- Affordable price comparable to non-biometric access readers

BioEntry™ Pass is an innovative fingerprint access reader offering unparalleled performance for physical access control using Suprema's award winning fingerprint recognition algorithm. Industry's fastest identification speed of BioEntry™ Pass eliminates the needs of keys, cards, or PINs even for a large enrollment of more than thousands of users. With BioEntry™ Pass, it's simple and enough – just place your finger.

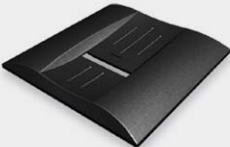
Optical	Capacitive	Swipe Thermal
		

■ Features

- World's most reliable fingerprint algorithm (No. 1 at FVC 2004)
- Industry's fastest matching speed (1 to 1000 in less than 1 second)
- Multiple choice of industry's leading fingerprint sensors
- Easy template distribution in network installations
- Flexible interface
(RS232/RS422/RS485, Wiegand input & output, Data/Clock output)
- User configurable I/O
(can be connected to switch, tamper alarm, or relay circuit)
- Tamper switch against vandalism
- Duress finger mode

BioEntry™ Pass

Fingerprint Access Reader

General Specifications

CPU	400 MHz DSP
Flash memory	4MB
EER	< 0.1%
Enrollment time	< 1 sec
Identification time	< 1 sec (1:1000 genuine matching)
Template size	256 ~ 384 bytes
Template capacity	9,000 at 4MB flash
Host communication	RS232/ RS422/ RS485
Aux. communication	RS232
Wiegand interface	1 input, 1 output
Data/Clock	output
External I/O	2 TTL input, 2 TTL output
Encryption	256 bit AES
Supply voltage	9 ~ 24 Vdc
Size	175 x 75 x 54 (L x W x H)

Model Specifications

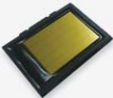
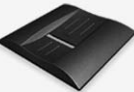
Ordering Model	BEP-OP	BEP-TC	BEP-FC
Sensor type	Optical	Capacitive	Swipe type Thermal
Resolution	500 dpi	508 dpi	500 dpi
Sensing area (mm)	16.0 x 19.0	12.8 x 18.0	14.2 x 0.4
Image size (Pixel)	280 x 320	256 x 360	280 x 8
			

BioEntry™ Pass Starter Kit

The starter kit of BioEntry™ Pass allows a user to easily evaluate the functionality of BioEntry™ Pass and helps integration and developments.

Contents:

- BioEntry™ Pass 1 unit
- Plastic stand 1 unit
- Starter kit interface board 1 unit
- USB fingerprint scanner (OP/TC only)
- Power adaptor and cables
- Software CD (BioEntry™ Admin)
- Technical documents

Operation Modes

- 1) Fingerprint identification (1:N matching)
- 2) Existing readers + Fingerprint verification (1:1 matching)

Configuration

1) Standalone

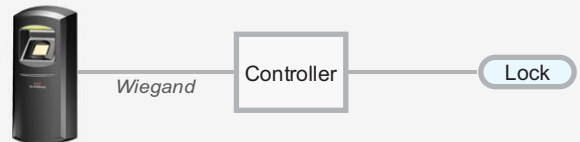

2) With existing readers



3) Network

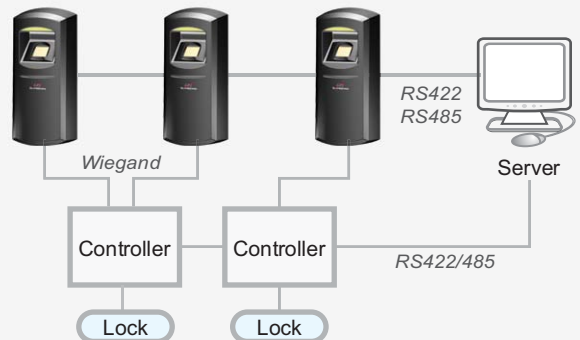

Enrollment Method

1) Enrollment station



2) Aux. ports



For sales and inquiries, please contact:

Suprema Inc.

16F Parkview Office Tower, Jeongja, Bundang, Seongnam, Gyeonggi, 463-863 Korea
Tel: +82-31-783-4502, Fax: +82-31-783-4503
E-mail: sales@supremainc.com, http://www.supremainc.com

