



www.supremainc.com

A graphic of a fingerprint with blue concentric circles radiating from the center, positioned behind the word "biostation".

biostation

Innovative Fingerprint Terminal

Installation Guide

(ver 1.1)

Contents

Product Contents	3
Connectors for External Interfaces	5
Cable and Connector Pinout	6
Installation Example	7
Product Dimension	8
Installation of Wall-mount Bracket	9
Power Connection	10
USB Cable Connection	11
LAN Connection	12
Wireless LAN Connection	13
RS485 Network Connection	14
USB Memory Connection	15
Intercom Connection	16
Relay Connection – Fail Safe Lock	17
Relay Connection – Fail Secure Lock	18
Relay Connection - Automatic Door	19
TTL Input Port Connection – RTE Switches	20
TTL Output Port Connection	21
Wiegand Input Connection – External reader	22
Wiegand Output Connection – Control Panel	23
Ferrite Core Installation	24
System Specification	25
Electrical Specification	26
FCC Rules	27

Product Contents

■ Basic Contents

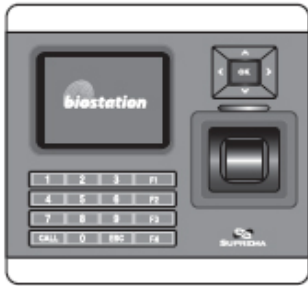

BioStation fingerprint terminal

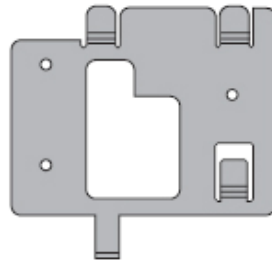

Wall mounting metal bracket



Wall mounting screws and holders - 3 ea



Star-shaped screw for fixing main body



USB cable



Star-shaped small wrench



5pin, 3pin, 6pin, 4pin, 7pin cable – 1 ea

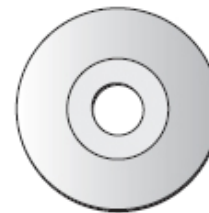

Software CD

Product Contents

- **Optional accessories**

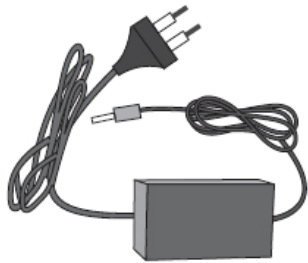

12V power adaptor

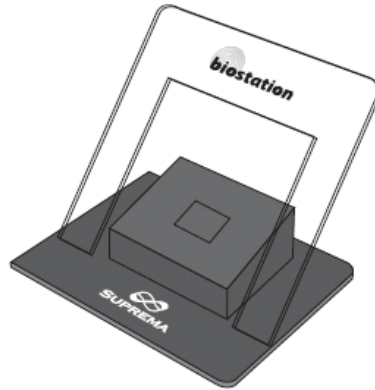

Plastic stand type A



Plastic stand type B



USB fingerprint scanner for enrollment on PC

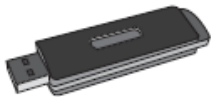

USB memory



Wireless LAN Access Point

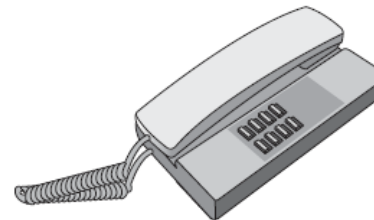

Interphone

Connectors for External Interfaces

■ Bottom

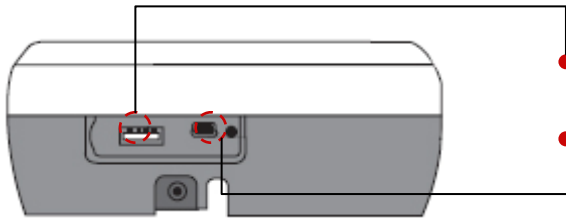

- Slot for USB memory device : USB type A
- Slot for PC USB connection : Mini USB

■ Rear

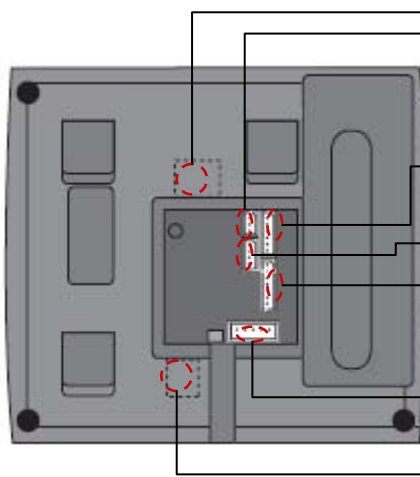

- Ethernet cable connector : RJ45
- 3pin cable connector - Door
- 6pin cable connector – Input/Output or Wiegand
- 4pin cable connector - RS485
- 7pin cable connector - RS232 or BEACon
- 5pin cable connector – Power and doorphone
- 12V power adaptor

Cable and Connector Pinout

Power & Doorphone



PIN	PIN DESCRIPTION	WIRE
1	POWER + (12Vdc)	RED
2	POWER -	BLACK
3	Doorphone AUDIO	ORANGE
4	Doorphone DATA	BLUE
5	SHIELD GND	GRAY

Relay



PIN	PIN DESCRIPTION	WIRE
1	NORMAL OPEN	WHITE
2	COMMON	BLUE
3	NORMAL CLOSE	ORANGE

TTL I/O or Wiegand



PIN	PIN DESCRIPTION	WIRE
1	TTL or Wiegand IN0	BLUE
2	TTL or Wiegand IN1	YELLOW
3	TTL or Wiegand OUT0	GREEN
4	TTL or Wiegand OUT1	WHITE
5	GND	BLACK
6	SHIELD GND	GRAY

RS485

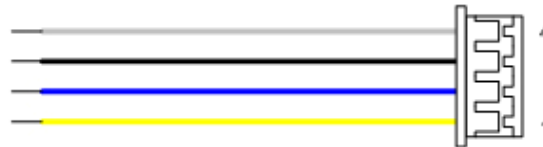

PIN	PIN DESCRIPTION	WIRE
1	TRX -	YELLOW
2	TRX +	BLUE
3	GND	BLACK
4	SHIELD GND	GRAY

RS232

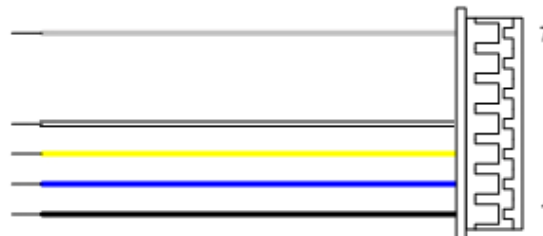

PIN	PIN DESCRIPTION	WIRE
1	GND	BLACK
2	RS-232 TX	BLUE
3	RS-232 RX	YELLOW
4	TTL OUT1	WHITE
7	SHIELD GND	GRAY

Installation Example

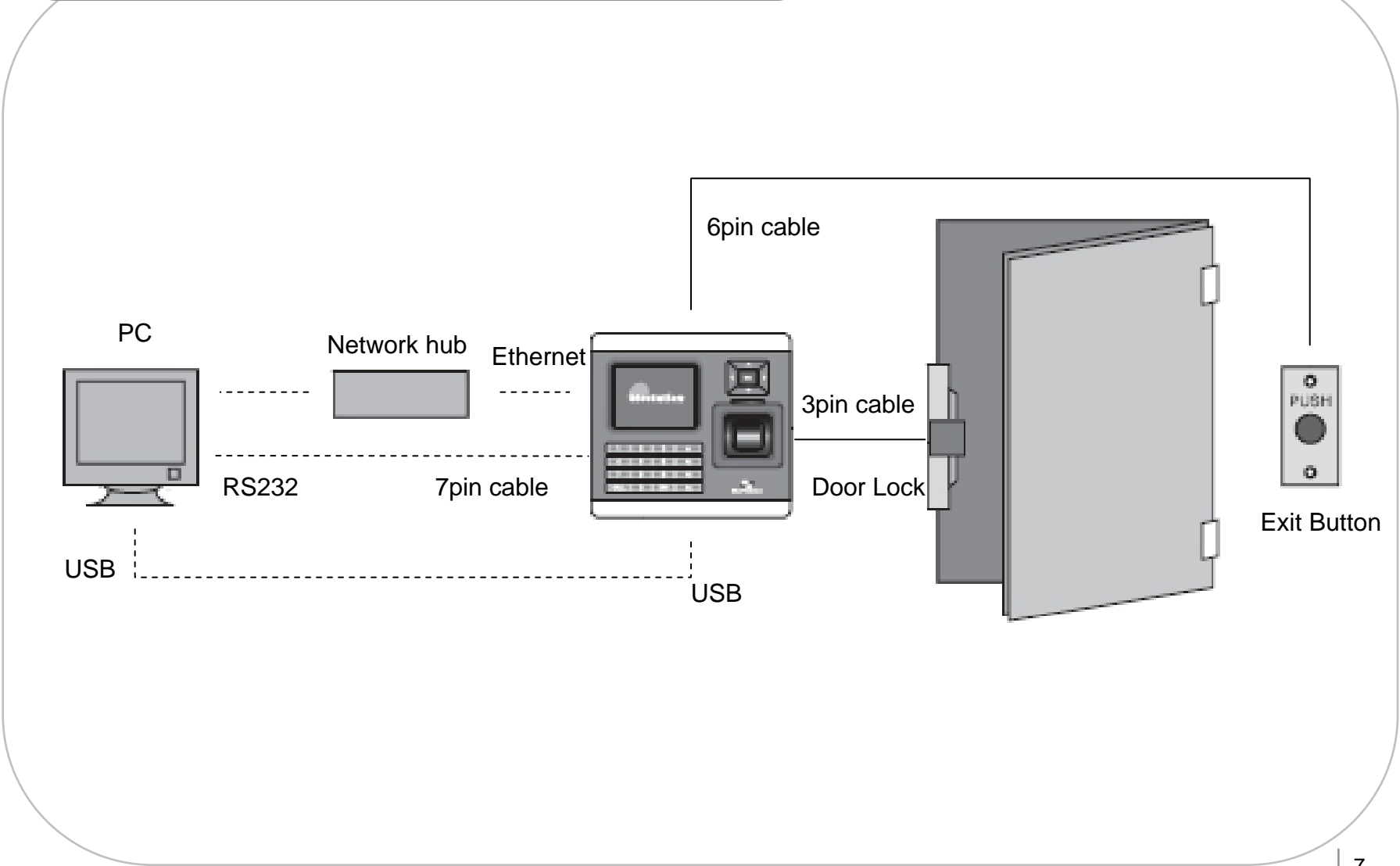

Product Dimension

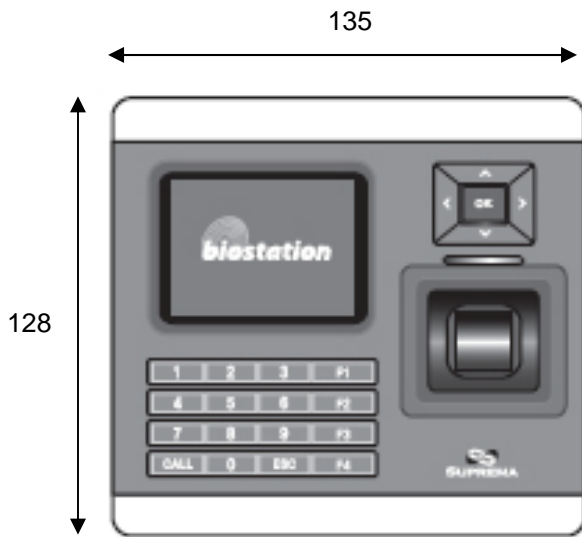

Front

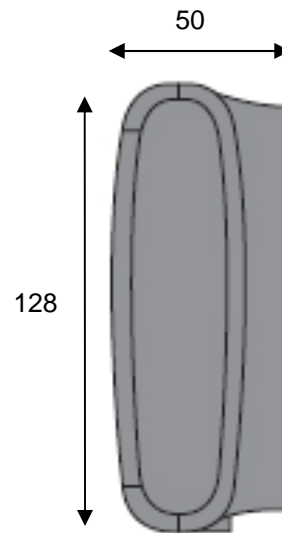

Side

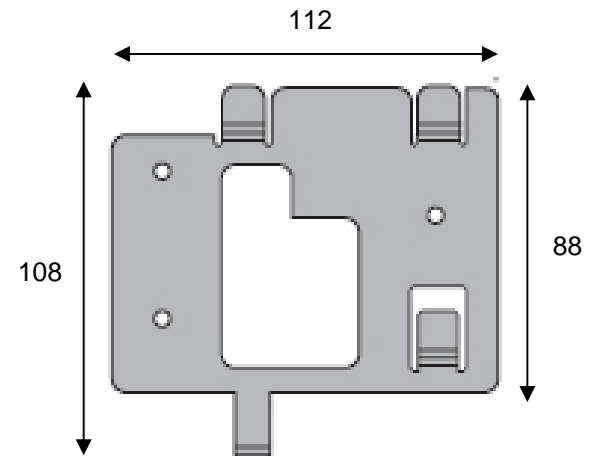

Bracket

(unit : mm)

Installation of Wall-mount Bracket

- **Fix wall mount bracket on a wall using wall mounting screws**

Wall Mounting
Screws

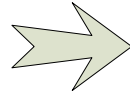
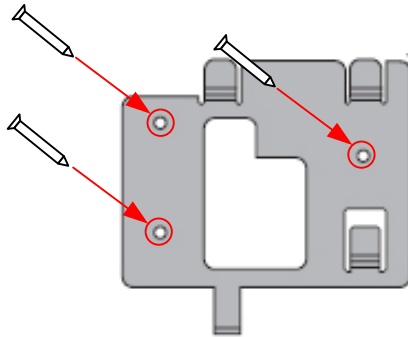

- **Hook BioStation on the wall mount bracket.**

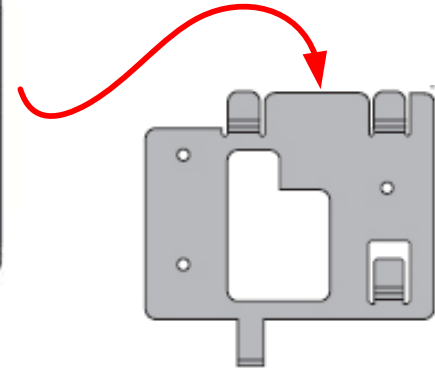

- **Fix BioStation and wall mounting bracket using a star shape screw.**

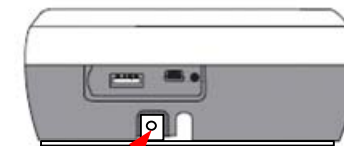

Star-shape Screw

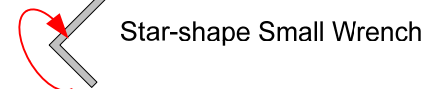

Star-shape Small Wrench

Power Connection

Method 1

DC12V ADAPTOR

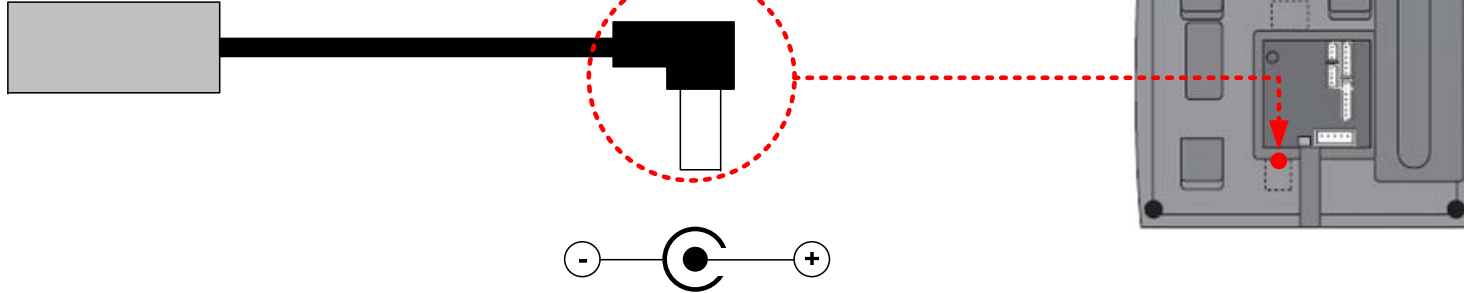

Method 2

DC12V POWER

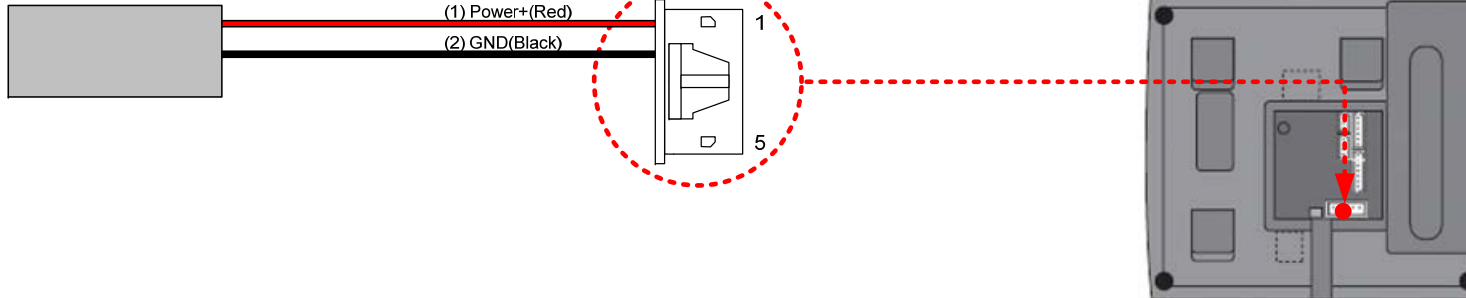

Recommended power supply

- 12V \pm 10%, at least 1500mA for BioStation alone installation.
- Comply with standard IEC/EN 60950-1
- To share the power with other devices, use a power supply with higher current ratings.

USB Cable Connection

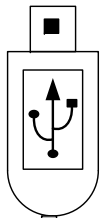
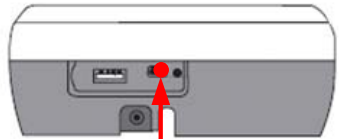

USB Mini Type

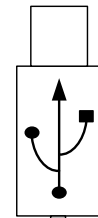
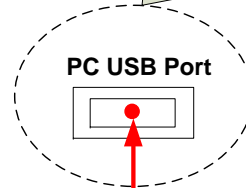
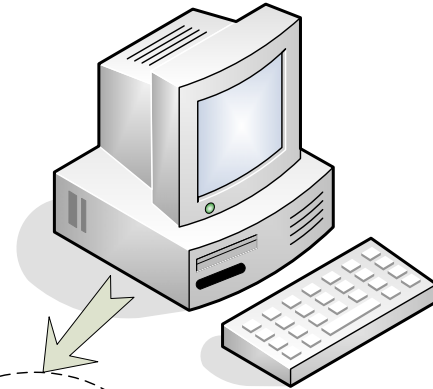

USB A Type

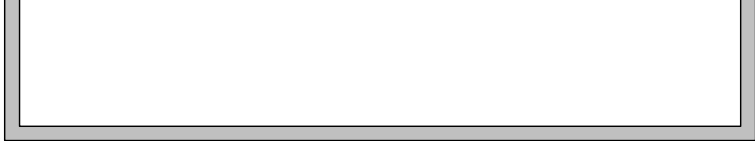

LAN Connection

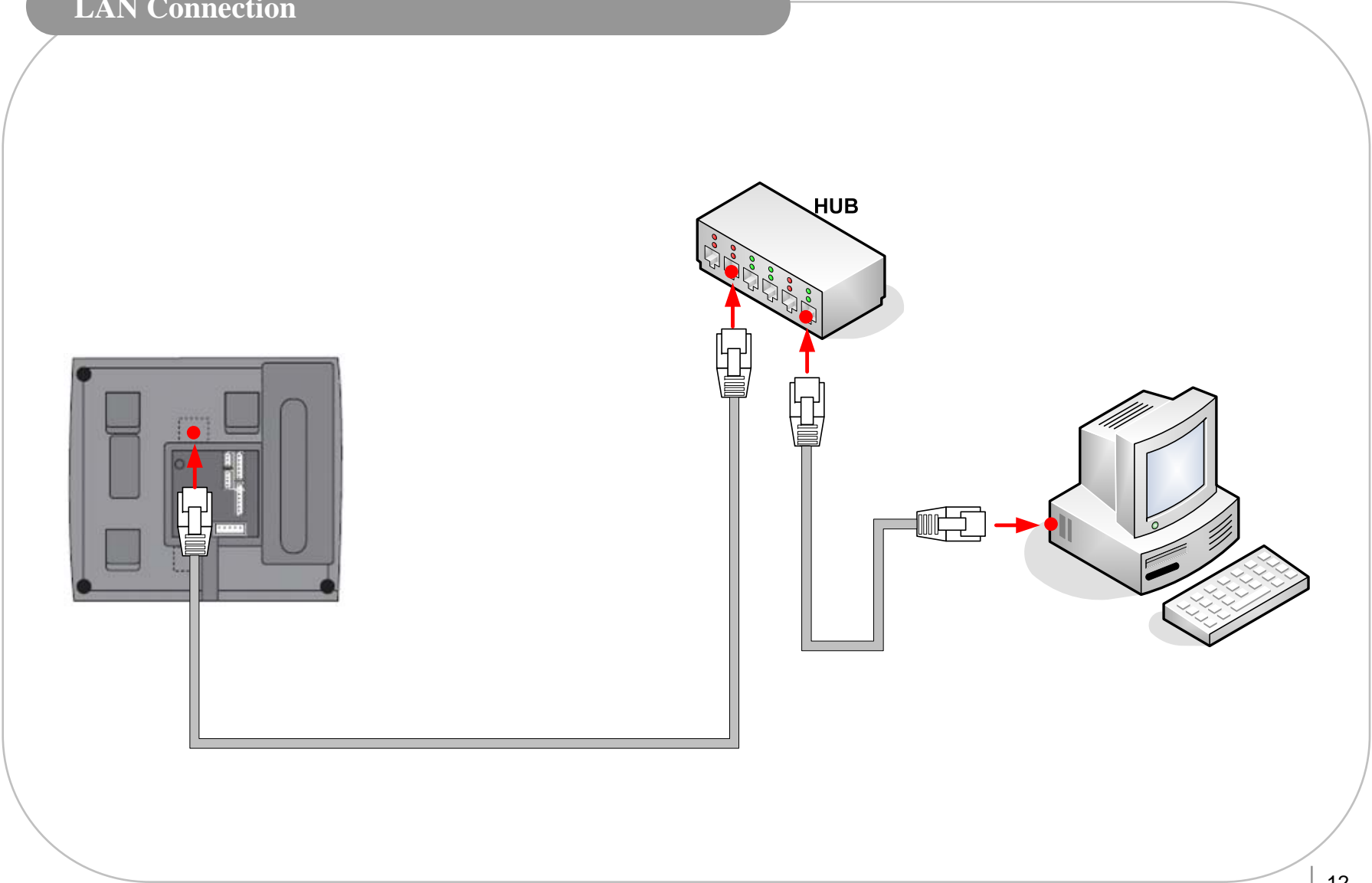

Wireless LAN Connection

- Performance of wireless LAN is affected a lot by surrounding environments and the type of AP(Access Point).
- The list of APs with compatibility tested with BioStation is as follows.
 - Buffalo WHR-HP-G54
 - Cisco-Linksys WRTH54GS
 - 3COM OfficeConnect 3CRWE554G72T
- Using an AP other than these lists, wireless LAN communication may not work properly.

★ Warning ★

If you installed USB Wireless LAN and closed rubber cap, there might be communication error or a fire due to the overheating.

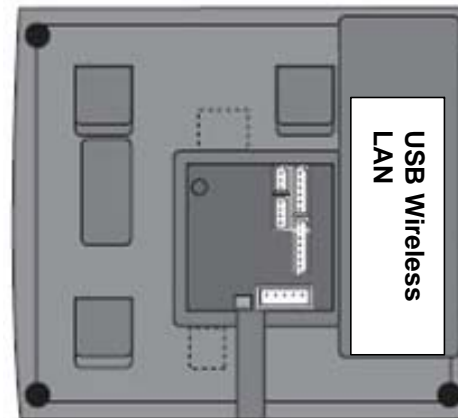
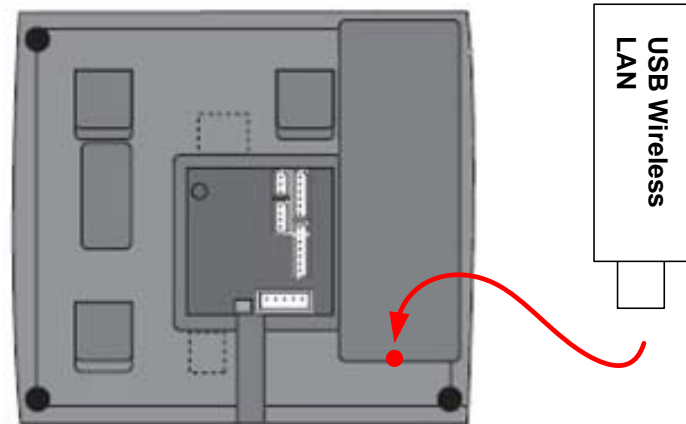

RS485 Network Connection

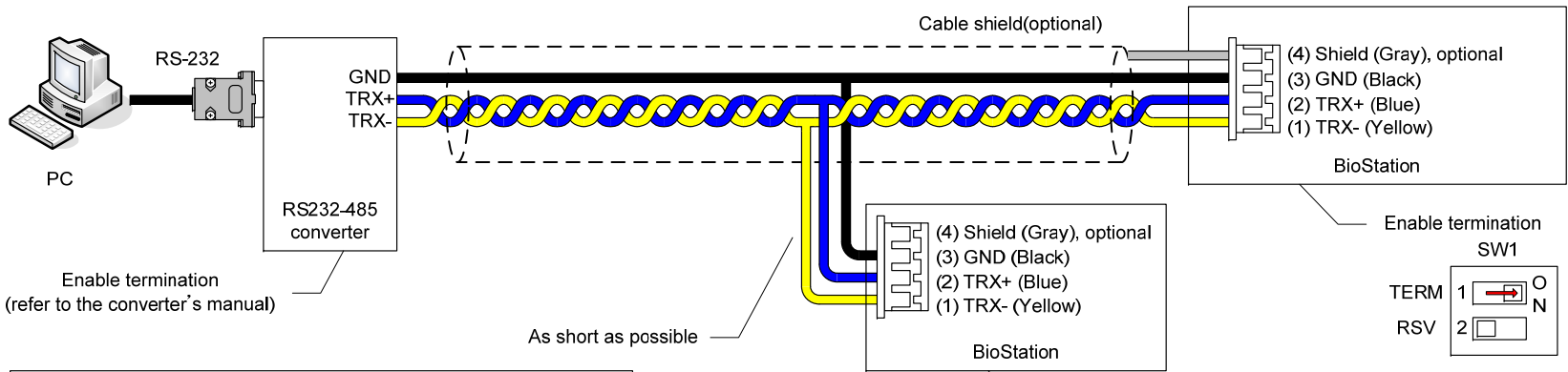

Important Notes

1. Only the devices at the both ends of the bus should be terminated.
2. Adjust the communication speed as needed. The signal quality vary depending on wiring conditions, and it may be necessary to lower the baudrates.
3. The GND signal may be omitted **if and only if** the GND potential difference is less than $\pm 5V$.

USB Memory Connection

- **Because of hardware compatibility issue, some USB memory devices may not work properly.**
- **The following is a list of USB memory devices already tested with BioStation.**
 - SanDisk cruzer micro 512MB
 - Transcend JF110 512MB
 - Transcend JF150 512MB
 - Samsung PLEOMAX SPUB-S50 1GB
 - Sony Microvault USM512J
 - Imation iFLASH Slim 512MB
 - Imation Swivel Pro 512MB
 - PQI Intelligent Stick 1GB

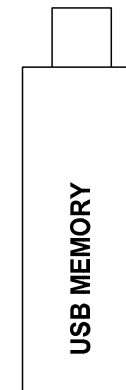
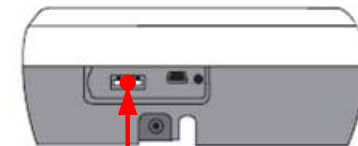

Intercom Connection

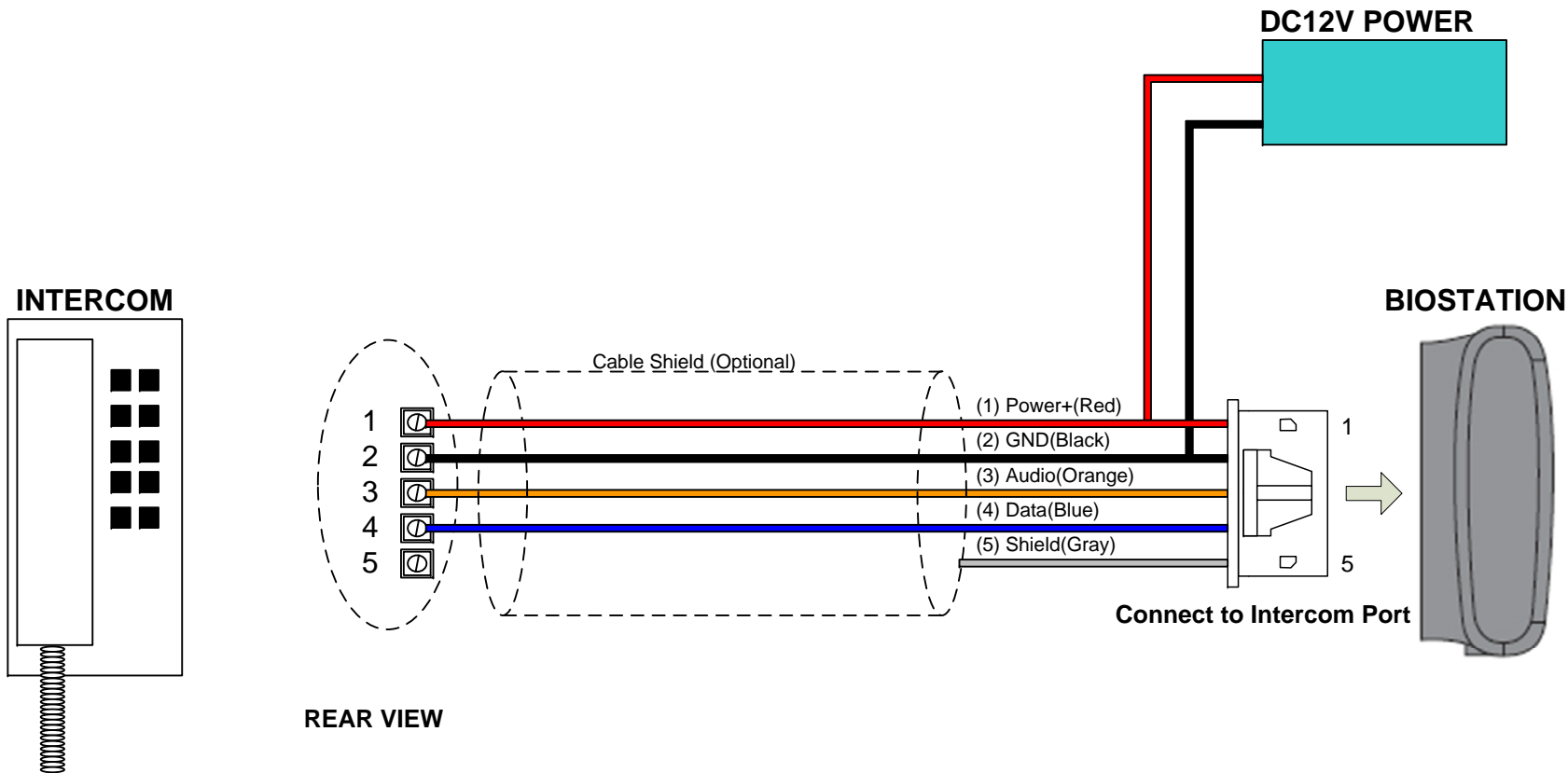

Relay Connection – Fail Safe Lock

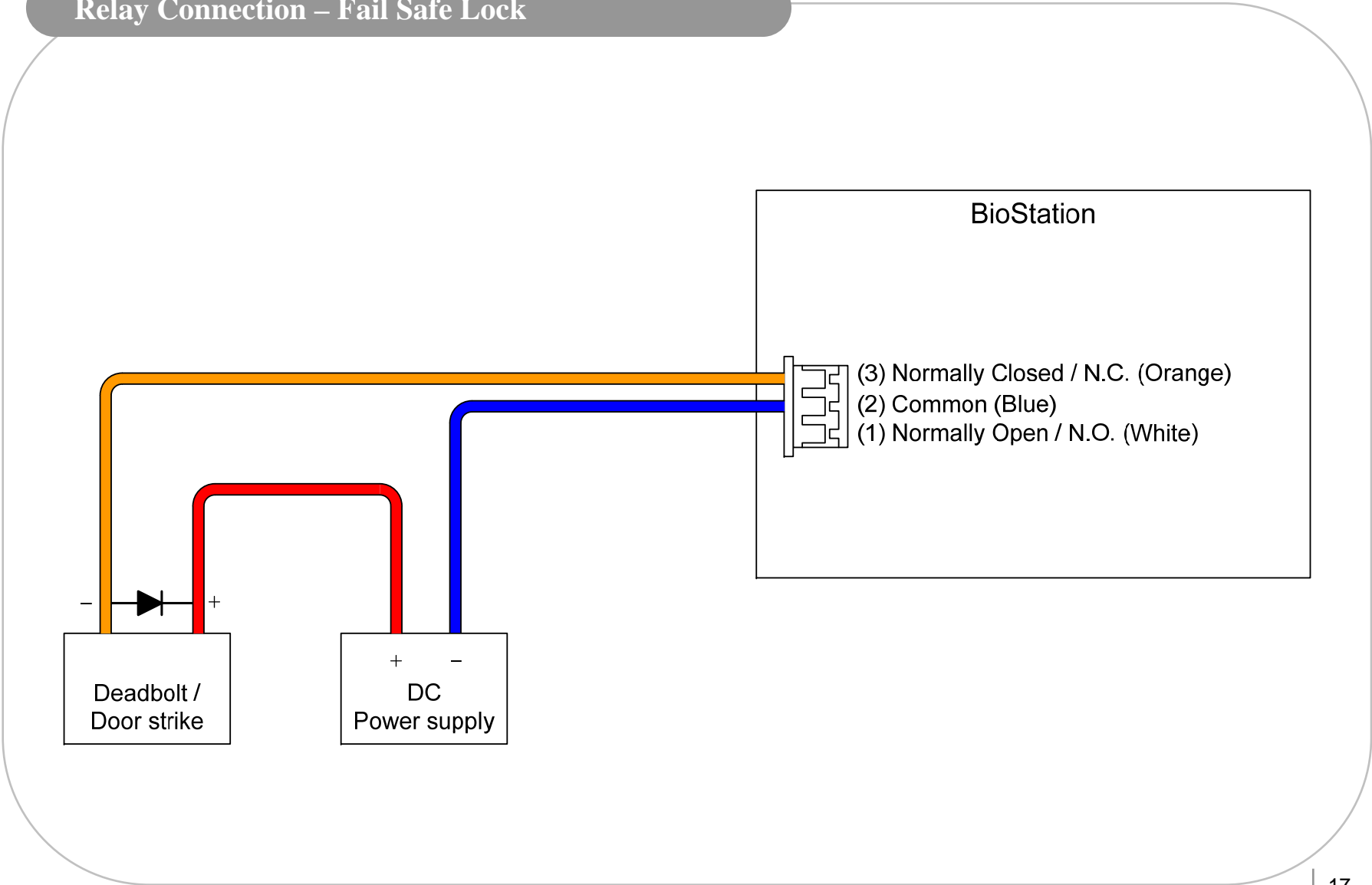

Relay Connection – Fail Secure Lock

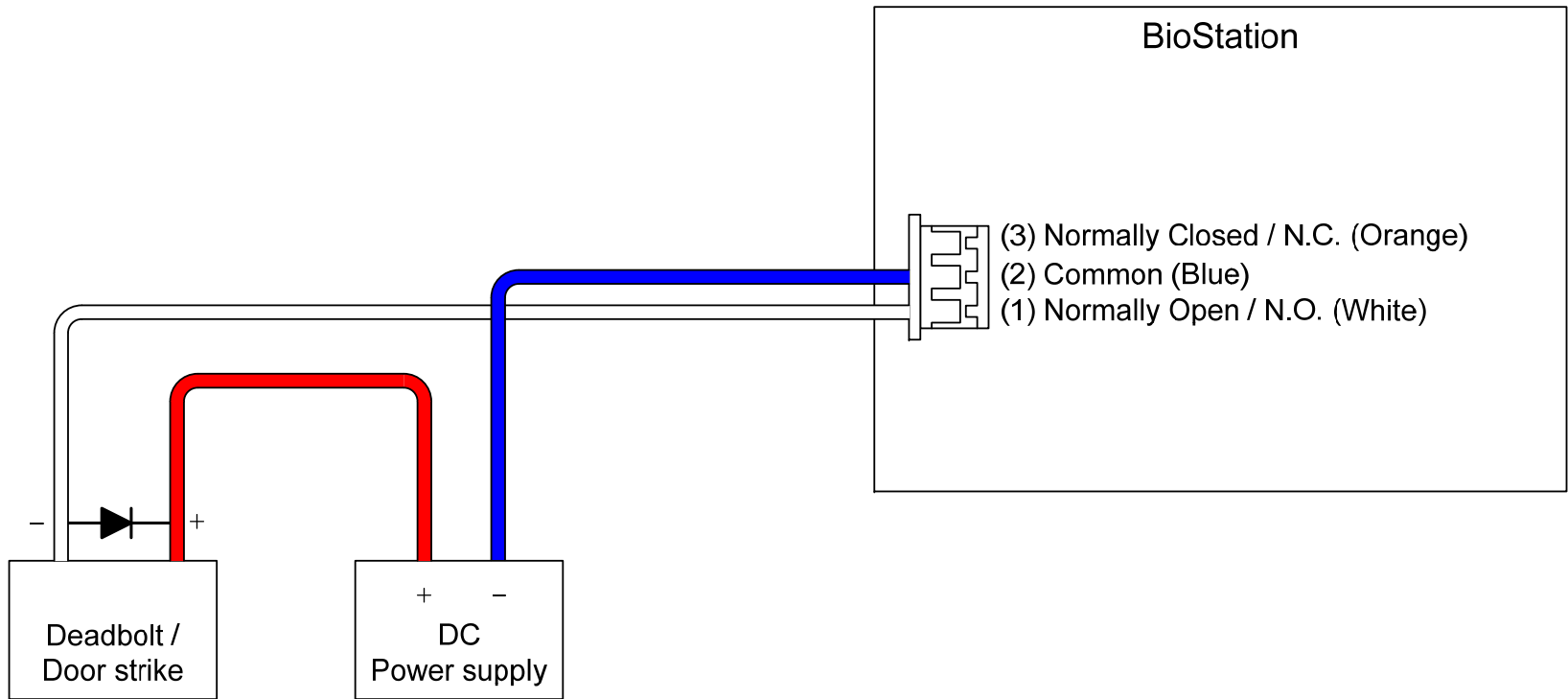

Relay Connection - Automatic Door

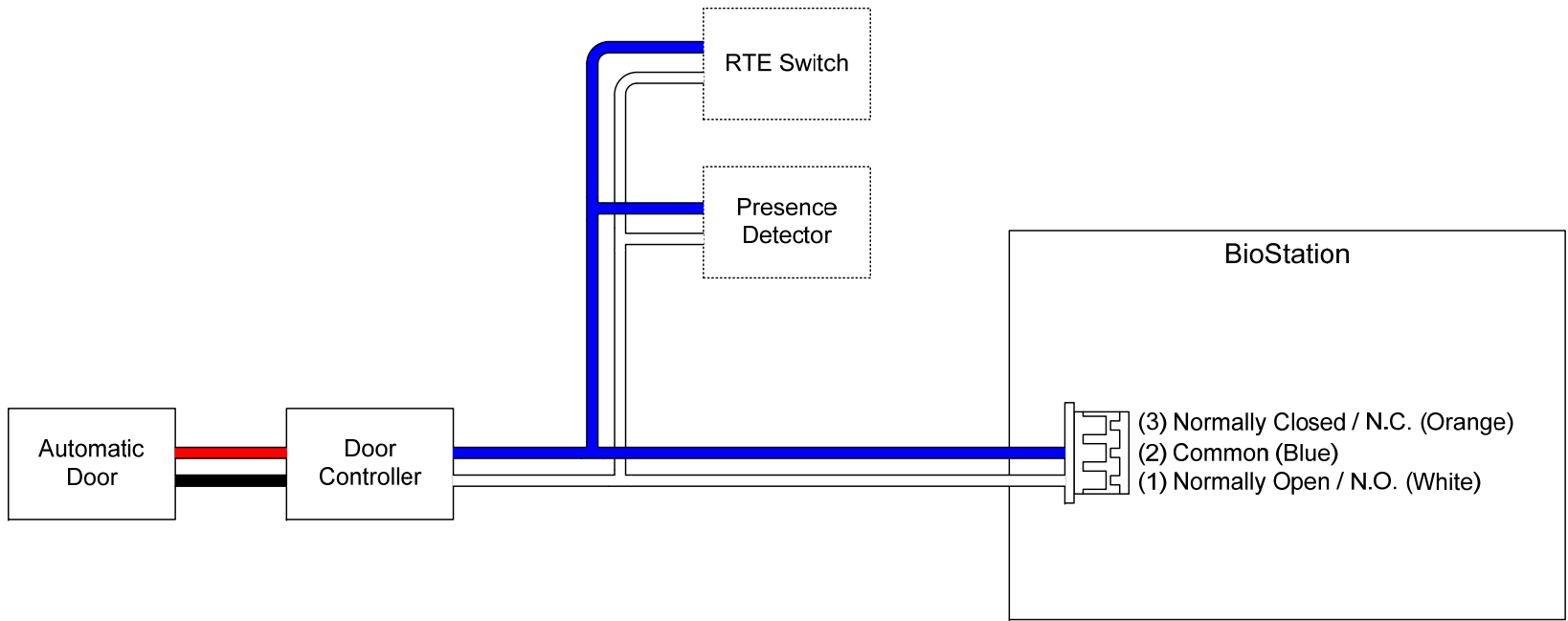

TTL Input Port Connection – RTE Switches

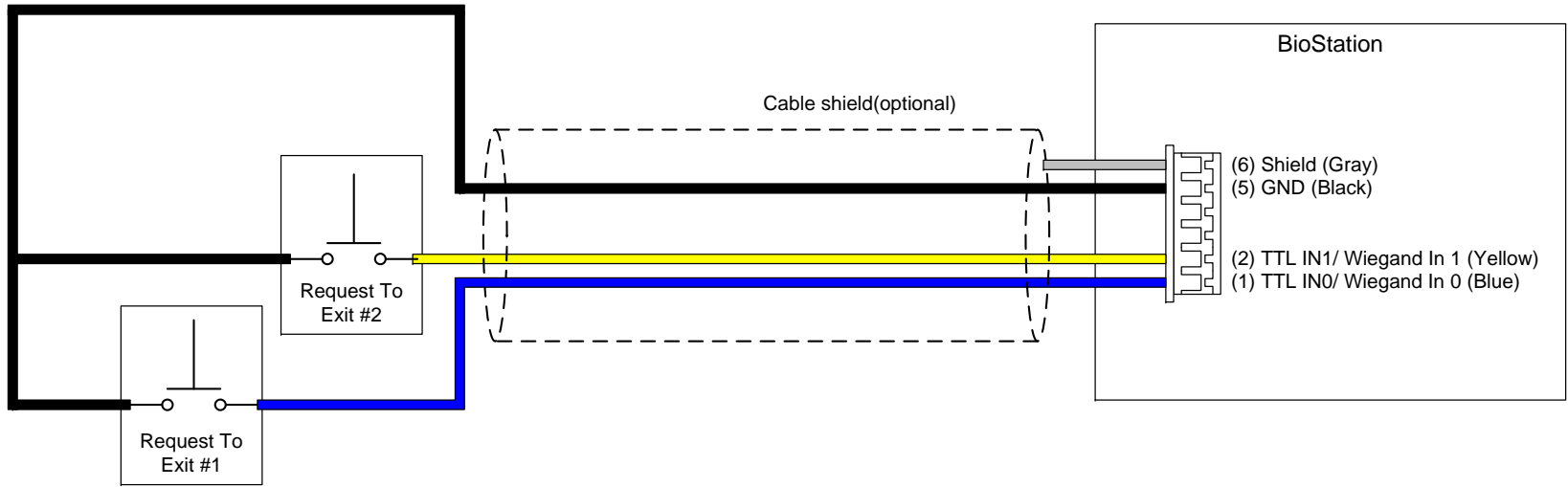

TTL Output Port Connection

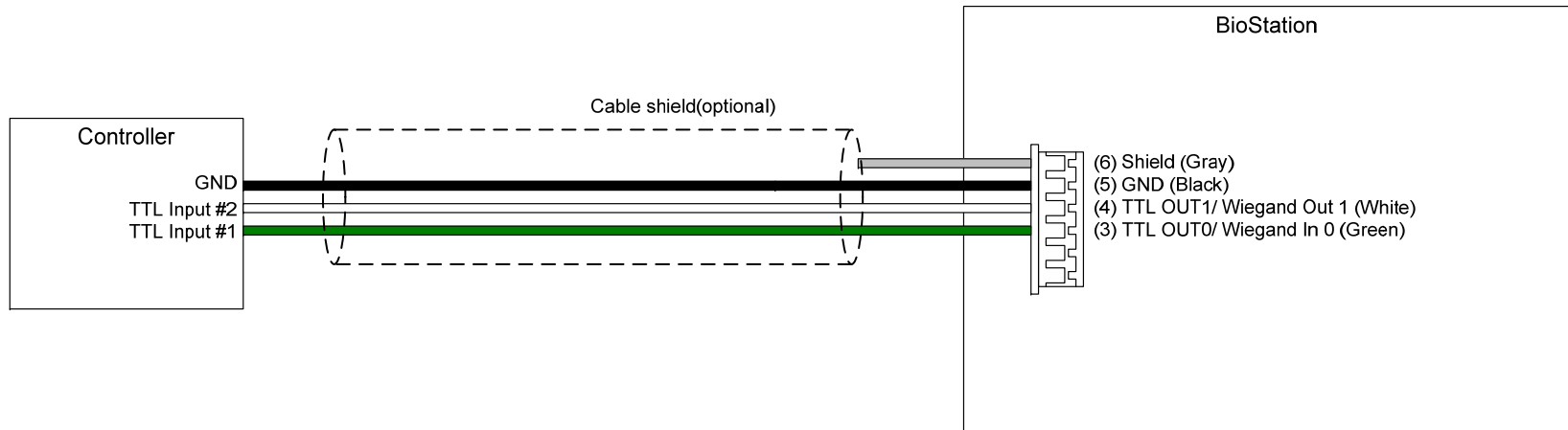

Wiegand Input Connection – External reader

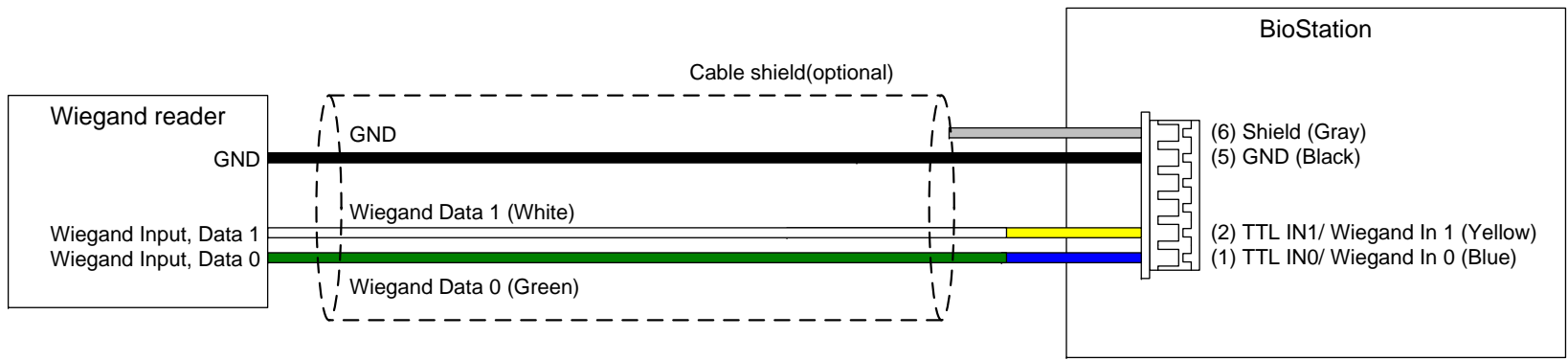

Wiegand Output Connection – Control Panel

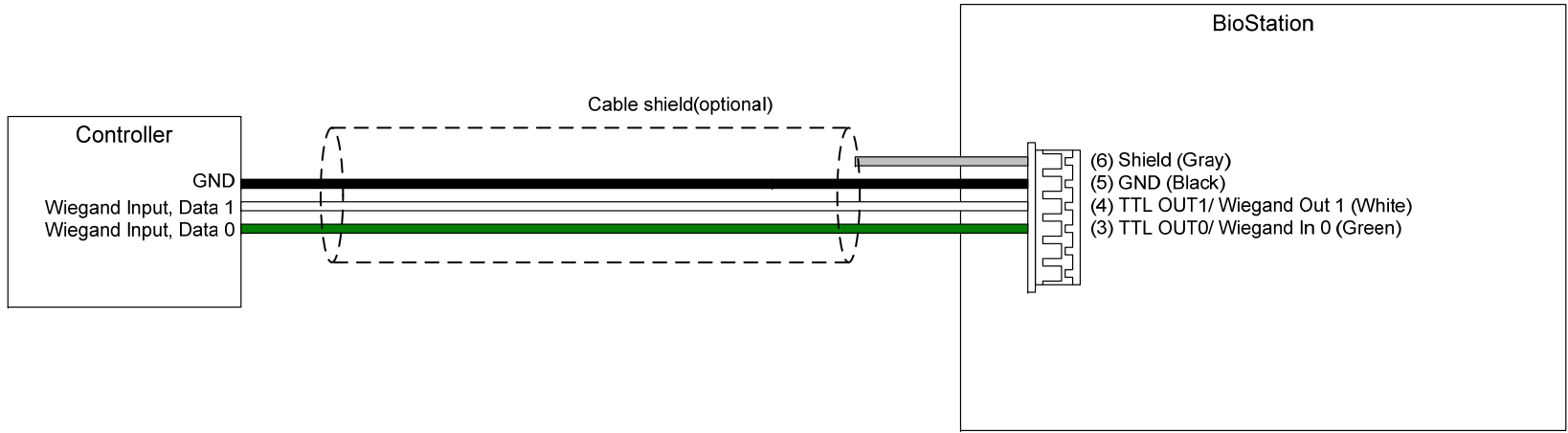

Ferrite Core Installation

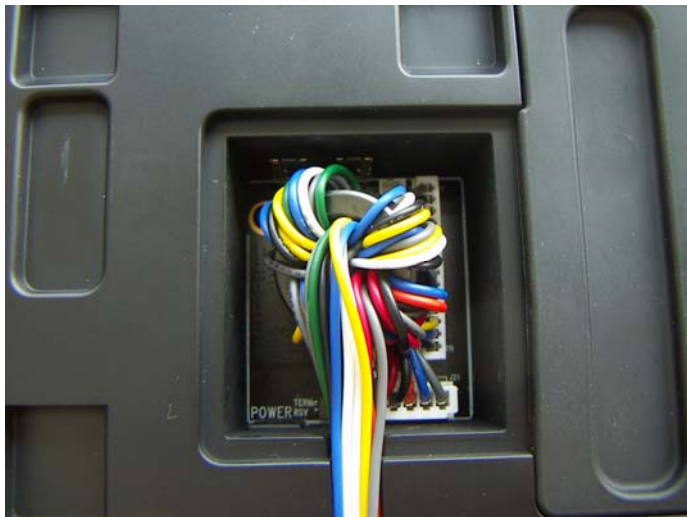

Core winding

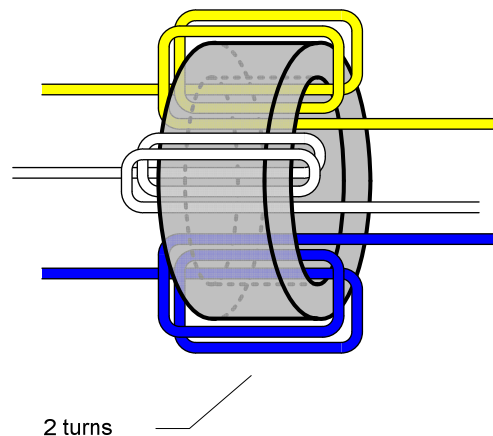

The following cables must be wound around the core (2 turns)

1. RS232 cable
2. RS485 cable
3. Intercom/Power cable
4. TTL/Wiegand IO cable

System Specifications

- **CPU : Dual CPU (32 bit RISC + 400MHz DSP)**
- **Memory : 72MB flash + 34MB RAM**
- **Display : 2.5 inch QVGA 16 million color LCD**
- **Identification speed : 3,000 fingerprints in 1 second**
- **Fingerprint capacity : 50,000 fingerprint templates**
- **Log capacity : 500,000 events**
- **Host interface : Wireless LAN (optional), TCP/IP, RS485**
- **PC interface : USB, RS232**
- **USB memory slot : USB host**
- **1 relay for deadbolt, EM lock, door strike, or automatic door**
- **Wiegand input/output, 4 TTL input/output**
- **Built-in microphone and speaker supporting door phone**
- **Convenient menu navigation key**
- **4 function keys for user defined functions**
- **Operation mode : Fingerprint, PIN, PIN+Fingerprint,
Card only*, Card+Fingerprint*, Card+PIN* (*RF model only)**
- **RF Card : 125KHz proximity (RF model only)**
- **RTC with backup battery (CR2032)****
- **Product size : 135 x 128 x 50 mm (width x length x depth)**

**** CAUTION** : RISK OF EXPLOSION IF BATTERY IS REPLACED BY AN INCORRECT TYPE. DISPOSE OF USED BATTERY ACCORDING TO THE INSTRUCTIONS

Electrical Specification

	Min.	Typ.	Max.	Notes
Power				
Voltage (V)	10.8	12	13.2	
Current (mA)	-	500	800	
TTL/Wiegand Input				
V _{IH} (V)	2	-	-	
V _{IL} (V)	-	-	0.8	
Pull-up resistance (Ω)	-	10k	-	
TTL/Wiegand Output				
V _{OH} (V)	4	-	-	@ I _{OH} = -5mA
V _{OL} (V)	-	-	1	@ I _{OL} = 5mA
Output resistance (Ω)	-	100	-	
Relay				
Switching capacity (A)	-	-	1 0.3	30V DC 125V AC
Switching power (resistive)	-	-	30W 37.5VA	DC AC
Switching voltage (V)	-	-	110 125	DC AC

FCC Rules

Caution

- Changes or modifications not expressly approved by the manufacturer responsible for compliance could void the user's authority to operate the equipment.

Warning

- This device complies with part 15 of the FCC Rules. Operation is subject to the following two conditions: (1) This device may not cause harmful interference, and (2) this device must accept any interference received, including interference that may cause undesired operation.

Information to User

- This equipment has been tested and found to comply with the limit of a Class B digital device, pursuant to Part 15 of the FCC Rules. These limits are designed to provide reasonable protection against harmful interference in a residential installation. This equipment generates, user and can radiate radio frequency energy and, if not installed and used in accordance with the instructions, may cause harmful interference to radio communications. However, there is no guarantee that interference will not occur in a particular installation; if this equipment does cause harmful interference to radio or television reception, which can be determined by turning the equipment off and on, the user is encouraged to try to correct the interference by one or more of the following measures:
 1. Reorient / Relocate the receiving antenna.
 2. Increase the separation between the equipment and receiver.
 3. Connect the equipment into an outlet on a circuit different from that to which the receiver is connected.
 4. Consult the dealer or an experienced radio/TV technician for help



Suprema Inc.
16F Parkview Office Tower, Jeongja-dong, Bundang-gu,
Seongnam, Gyeonggi, 463-863 Korea
E-mail : support@supremainc.com
Website : www.supremainc.com

Functions and specifications of the product are subject to changes without notice due to quality enhancement or function update. For any inquiry on the product, please contact **Suprema Inc.**