

Alarm Control Panel

CA-10

Program Version 4.9

Satel 

GDAŃSK

PROGRAMMING



Latest EC declaration of conformity and product approval certificates can
be downloaded from our Web site www.satel.pl



CONTENTS

INTRODUCTION	5
SERVICE MODE [SERVICE CODE][#] OR [SERVICE CODE][*]	5
CALLING THE CONTROL PANEL SERVICE FUNCTIONS	5
CALLING THE SERVICE FUNCTIONS IN LED KEYPADS	5
CALLING THE SERVICE FUNCTIONS IN LCD KEYPADS.....	5
PROGRAMMING THE SERVICE FUNCTIONS BY MEANS OF KEYPAD	10
BIT FUNCTIONS IN THE LED KEYPADS.....	10
BIT FUNCTIONS IN THE LCD KEYPADS.....	10
BIT FUNCTIONS WITH A LIST IN THE LCD KEYPADS.....	10
DEC FUNCTIONS IN THE LED KEYPADS.....	10
DEC FUNCTIONS IN THE LCD KEYPADS.....	11
HEX FUNCTIONS IN THE LED KEYPADS.....	11
HEX FUNCTIONS IN THE LCD KEYPADS.....	11
TABLE OF CHARACTER CODING FOR LED KEYPADS	12
EDITING TEXTS IN THE LCD KEYPADS.....	12
DESCRIPTION OF THE PANEL SERVICE FUNCTIONS	13
FS0 - quit service mode	13
FUNCTIONS PROGRAMMING BASIC OPTIONS	13
FS1 - changing service code	13
FS2 - programming control panel identifier (HEX).....	13
FS3 - programming computer identifier (HEX)	13
FS4 - programming computer telephone number (HEX).....	14
FS5 - programming the system options (BIT).....	15
FS6 - programming the global times (DEC).....	17
FS7 - programming the counting zone counters (DEC).....	17
FUNCTIONS PROGRAMMING PARTITION ASSIGNMENT	18
FS8 - zones assignment to partition 1 (BIT)	18
FS9 - zones assignment to partition 2 (BIT)	18
FS10 - zones assignment to partition 3 (BIT)	18
FS11 - zones assignment to partition 4 (BIT)	18
FS12 - programming zones displayed in partition 1 keypad (BIT).....	18
FS13 - programming zones displayed in partition 2 keypad (BIT).....	18
FS14 - programming zones displayed in partition 3 keypad (BIT).....	18
FS15 - programming zones displayed in partition 4 keypad (BIT).....	18
FS16 - programming auto-bypassed zones in partition 1 (BIT)	18
FS17 - programming auto-bypassed zones in partition 2 (BIT)	18
FS18 - programming auto-bypassed zones in partition 3 (BIT)	18
FS19 - programming auto-bypassed zones in partition 4 (BIT)	18
FS20 - programming partition 1 options (BIT)	19
FS21 - programming partition 2 options (BIT)	20
FS22 - programming partition 3 options (BIT)	20
FS23 - programming partition 4 options (BIT)	21
FUNCTIONS PROGRAMMING ZONE PARAMETERS	21
FS24 - programming zone sensitivity.....	21
FS25 - programming zone type (DEC)	22
FS26 - programming zone reaction type (DEC)	23
FS27 - programming zone options (BIT).....	23
FS28 - programming individual entry delay (DEC)	24
FS29 - programming maximum zone violation times.....	25
FS30 - programming the zone no violation time	25
FUNCTIONS PROGRAMMING OUTPUT PARAMETERS.....	25
FS31 - programming OUT1 output	25
FS32 - programming list of zones OUT1 (BIT)	28
FS33 - programming OUT2 output	28
FS34 - programming list of zones OUT2 (BIT)	28

FS35 - programming OUT3 output	28
FS36 - programming list of zones OUT3 (BIT)	28
FS37 - programming OUT4 output	29
FS38 - programming list of zones OUT4 (BIT)	29
FS39 - programming OUT5 output	29
FS40 - programming list of zones OUT5 (BIT)	29
FS41 - programming OUT6 output	29
FS42 - programming list of zones OUT6 (BIT)	29
MONITORING - PROGRAMMING PARAMETERS OF TRANSMISSION TO MONITORING STATIONS	29
FS43 - programming station 1 telephone number (HEX)	29
FS44 - programming station 2 telephone number (HEX)	29
FS45 - programming station 1 format (HEX)	29
FS46 - programming station 2 format (HEX)	29
FS47 - programming reporting options (BIT)	30
MONITORING - PROGRAMMING IDENTIFIERS	31
FS48 - programming zone events identifier for station 1 (HEX)	31
FS49 - programming partition 1 events identifier for station 1 (HEX)	31
FS50 - programming partition 2 events identifier for station 1 (HEX)	31
FS51 - programming partition 3 events identifier for station 1 (HEX)	31
FS52 - programming partition 4 events identifier for station 1 (HEX)	31
FS53 - programming system events identifier for station 1 (HEX)	31
FS54 - programming zone events identifier for station 2 (HEX)	31
FS55 - programming partition 1 events identifier for station 2 (HEX)	31
FS56 - programming partition 2 events identifier for station 2 (HEX)	31
FS57 - programming partition 3 events identifier for station 2 (HEX)	32
FS58 - programming partition 4 events identifier for station 2 (HEX)	32
FS59 - programming system events identifier for station 2 (HEX)	32
MONITORING - PROGRAMMING ZONE REPORT CODES	32
FS60 - programming zone alarm codes (HEX)	32
FS61 - programming zone tamper alarm codes (HEX)	32
FS62 - programming zone trouble codes (HEX)	33
FS63 - programming zone violation codes (HEX)	33
FS64 - programming zone RESTORE codes (HEX)	33
FS65 - programming zone TAMPER RESTORE codes (HEX)	33
FS66 - programming zone TROUBLE RESTORE codes (HEX)	33
FS67 - programming zone events assignment to station 1 (BIT)	33
FS68 - programming zone events assignment to station 2 (BIT)	33
MONITORING - PROGRAMMING PARTITION REPORT CODES	34
FS69 - programming partition 1 events codes (HEX)	34
FS70 - programming partition 2 events codes (HEX)	34
FS71 - programming partition 3 events codes (HEX)	34
FS72 - programming partition 4 events codes (HEX)	34
FS73 - programming partition 1 events assignment to station 1 (BIT)	35
FS74 - programming partition 2 events assignment to station 1 (BIT)	35
FS75 - programming partition 3 events assignment to station 1 (BIT)	35
FS76 - programming partition 4 events assignment to station 1 (BIT)	35
FS77 - programming partition 1 events assignment to station 2 (BIT)	35
FS78 - programming partition 2 events assignment to station 2 (BIT)	35
FS79 - programming partition 3 events assignment to station 2 (BIT)	35
FS80 - programming partition 4 events assignment to station 2 (BIT)	35
MONITORING - PROGRAMMING SYSTEM REPORT CODES	35
FS81 - programming system events codes - set I (HEX)	35
FS82 - programming system events codes - set II (HEX)	36
FS83 - programming system event assignment to station 1 (BIT)	36
FS84 - programming system event assignment to station 2 (BIT)	37
FS85 - programming test transmission time (DEC)	37
FS86 - programming the „AC loss” report delay (DEC)	37
MESSAGING – PROGRAMMING TELEPHONE NUMBER	37
FS87 - programming telephone number 1 (HEX)	37
FS88 - programming telephone number 2 (HEX)	37
FS89 - programming telephone number 3 (HEX)	37

FS90 - programming telephone number 4 (HEX)	38
FS91 - programming telephone number 5 (HEX)	38
FS92 - programming telephone number 6 (HEX)	38
FS93 - programming telephone number 7 (HEX)	38
FS94 - programming telephone number 8 (HEX)	38
FS95 - programming assignment of partitions and messages (BIT)	38
MESSAGING – PROGRAMMING OF PAGER MESSAGES	39
FS96 - programming message 1 (POLPAGER format)	39
FS97 - programming message 2 (POLPAGER)	39
FS98 - programming message 3 (POLPAGER)	39
FS99 - programming message 4 (POLPAGER)	39
MESSAGING – PROGRAMMING OF MESSAGING PARAMETERS	40
FS100 - programming number of queues and retries in a queue (DEC)	40
FS101 - programming number of rings before answer (DEC)	40
FUNCTIONS PROGRAMMING TIMERS	40
FS102 - programming TIMER 1 (DEC)	40
FS103 - programming TIMER 2 (DEC)	41
FS104 - programming TIMER 3 (DEC)	41
FS105 - programming TIMER 4 (DEC)	41
FS106 - programming TIMER functions (DEC)	41
SPECIAL FUNCTIONS	42
FS107 – factory default settings restoration	42
FS108 - clearing event log	42
FS109 - factory default identifiers restoration	42
FS110 - factory default codes restoration	42
FS111 - programming keypad addresses (BIT)	42
FS112 - start of programming through RS-232	43
FUNCTIONS RELATED TO MEMORY OF EVENTS	44
FS113 - event log printout (all events)	44
FS114 - alarm log printout	44
FS115 - trouble log printout	44
FS116 - partition event printout (arming/disarming)	44
MESSAGING – PROGRAMMING OF MESSAGING PARAMETERS	44
FS117 - permissible telephone line loss delay (DEC)	44
FS118 - parameters of pager station signals (HEX)	44
MESSAGING – PROGRAMMING OF HEX MESSAGES	45
FS119 - programming message 1 (HEX)	45
FS120 - programming message 2 (HEX)	45
FS121 - programming message 3 (HEX)	45
FS122 - programming message 4 (HEX)	45
FUNCTIONS PROGRAMMING BASIC OPTIONS	45
FS123- counters count-up times	45
SPECIAL FUNCTIONS	46
FS124- keypad address auto-detect	46
FS125- testing outputs	46
MONITORING - PROGRAMMING SYSTEM REPORTING CODES	46
FS126- programming guard control codes (HEX)	46
FUNCTIONS PROGRAMMING PARTITION ASSIGNMENT	47
FS127- zones auto-bypassed on no exit in partition 1 (BIT)	47
FS128- zones auto-bypassed on no exit in partition 2 (BIT)	47
FS129- zones auto-bypassed on no exit in partition 3 (BIT)	47
FS130- zones auto-bypassed on no exit in partition 4 (BIT)	47
SPECIAL FUNCTION	47
FS131 - programming additional options (BIT)	47
FS132 - programming of clock correction (DEC)	49
MONITORING - PROGRAMMING SYSTEM REPORT CODES	49
FS133 - programming the time of test transmission to the monitoring station (DEC)	49
MONITORING – PROGRAMMING ZONE REPORT CODES	49
FS134 - programming codes to bypass the control panel zones (HEX)	49
FS135 - programming codes to unypass the control panel zones (HEX)	50

MONITORING	50
FS136 – programming of prefix for extension of identifiers in TELIM transmission format	50
FS137 - programming codes to be sent to the monitoring station in TELIM transmission format	50
MONITORING – PROGRAMMING OF IDENTIFIERS.....	50
FS-138 - programming of VISONIC radio system address (DEC).....	50
FS-139 - programming the test transmission period for VISONIC radio system (DEC)	50
LCD KEYPAD SERVICE FUNCTIONS	50
NAMES	53
TEXTS	53
SYMBOLS	53
LED standard characters	53
LCD standard characters	53
SETTINGS	53
Time format	53
Status format	53
Display backlight	54
Keypad backlight	54
Keypad address	54
GOTO function	54
Options	54
RESET DEFAULTS	55
TEST	55
RESTORING DEFAULT SETTINGS, RESTORING CODES	56
RESTORATION OF SETTINGS ON ENTERING THE SERVICE MODE BY MEANS OF SERVICE CODE	56
RESTORATION OF SETTINGS ON ENTERING THE SERVICE MODE BY HARDWARE MEANS	56
RESTORATION OF SETTINGS WHEN THE OPTION TO ENTER THE SERVICE MODE BY HARDWARE MEANS IS LOCKED AND IT IS IMPOSSIBLE TO USE THE SERVICE CODE	56

Introduction

Design and program flexibility of the CA-10 control panel give the installer a full freedom of choice in defining the alarm system functions and operating mode. Additionally, they allow some extra functions to be assigned to the panel (for example, control of lighting , locks, cameras).

All the control panel parameters can be programmed by means of the keypad or PC computer (locally via RS-232 or remotely via the modem). **Programming with the keypad is possible after starting the service mode.**

Service Mode [SERVICE CODE][#] or [SERVICE CODE][*]

The service mode can be started from the keypad in any disarmed and non-alarming partition. In order to start the service mode, enter the service code (by default=12345) and confirm it with the key [#] or [*]. The service mode is indicated by alternate blinking of the ALARM LED and the PARTITION LED corresponding to the partition, where the keypad is (for the CA-10KLED keypad it is the ARMED LED) and a short beep is generated every 3 seconds. The other partitions function normally, alarms being only signaled in the keypads and reported to the monitoring station. No keypad tamper conditions or addresses are checked in the service mode. The service mode is on until deactivated by the service function (FS0). It can also be exited with a computer command from the DLOAD program.

Calling the control panel service functions

Calling in the service function is signaled by lighting of the TROUBLE LED. Depending on the keypad type (LED or LCD), the service functions can be started in various ways.

Calling the service functions in LED keypads

Having started the service mode, call the function by entering the function number from the keypad and pressing the key [#].

Calling the service functions in LCD keypads

Having started the service mode, you can see the following message appear on the display:

Service menu
Menu: ↑ ↓ ← →

You can move through the menu by means of the arrow keys. Pressing any arrow key will bring the service mode hierarchical menu to the display, which facilitates access to the service functions. The menu is organized so that the control panel particular service functions are grouped by topics.

The keys ▲▼ enable the menu to be scrolled.

You can enter a submenu or start the function shown by arrow on the display either by pressing the key ► or [#].

In order to quit the submenu or the function, press the key ◀ or [*], or, alternatively, the key combination [*] and [#]. It depends on the type of function – in some functions, the keys [*] and ◀ are used for editing.

For example, if the display arrow shows *Monitoring*, the subsequent strokes of the key ▶ or [#] result in jumping to the first function of the functional block used to program the monitoring parameters, while the key ◀ or [*] makes it possible to go back to the successive menu levels:

Monitoring



Report stations



MS1 tel. no.



Report stations



Monitoring

In the LCD keypad, the functions can also be called in the service mode by entering the function number from the keypad, followed by pressing the [#] key, in the same way as in the LED keypads.

The following pages show the structure of the menu. The functions programming the LCD keypad are grouped in a separate menu described later in this guide.

Service mode menu:

Basic options	1.	Service code		
	2.	Panel ident.	(Panel identifier)	
	3.	PC identifier	(Computer identifier)	
	4.	PC tel. number	(Computer telephone number)	
	5.	Syst. options	(System options)	
	6.	Global times		
	7.	Counters		
Partitions def.	123.	Cnt. times	(Counters times)	
	8.	Part.1 zones	(Zones of partition 1)	
	9.	Part.2 zones	(Zones of partition 2)	
	10.	Part.3 zones	(Zones of partition 3)	
	11.	Part.4 zones	(Zones of partition 4)	
	12.	Kpd.1 zones	(Zones displayed on keypad1)	
	13.	Kpd.2 zones	(Zones displayed on keypad2)	
	14.	Kpd.3 zones	(Zones displayed on keypad3)	
	15.	Kpd.4 zones	(Zones displayed on keypad4)	
	16.	P.1 bypasses	(Partition 1 auto-bypassed zones)	
	17.	P.2 bypasses	(Partition 2 auto-bypassed zones)	
	18.	P.3 bypasses	(Partition 3 auto-bypassed zones)	
	19.	P.4 bypasses	(Partition 4 auto-bypassed zones)	
	20.	P.1 options	(Partition 1 options)	
	21.	P.2 options	(Partition 2 options)	
	22.	P.3 options	(Partition 3 options)	
	23.	P.4 options	(Partition 4 options)	
	Zones	127.	ZoBypsNoEx1	(Zones auto-bypassed on no exit in partition 1)
		128.	ZoBypsNoEx2	(Zones auto-bypassed on no exit in partition 2)
		129.	ZoBypsNoEx3	(Zones auto-bypassed on no exit in partition 3)
		130.	ZoBypsNoEx4	(Zones auto-bypassed on no exit in partition 4)
		24.	Zone sensit.	(Zones sensitivity)
		25.	Zone types	
26.		Reaction typ	(Reaction type)	
27.		Zone options		
28.		Entry delays		
29.		Max.viol.tim	(Maximum violation time)	
30.		Max.no v.tim	(Maximum no violation time)	
Outputs		31.	Output OUT1	(Output OUT1 programming)
	32.	OUT1 zones	(Zones assigned to OUT1)	
	33.	Output OUT2	(Output OUT2 programming)	
	34.	OUT2 zones	(Zones assigned to OUT2)	
	35.	Output OUT3	(Output OUT3 programming)	
	36.	OUT3 zones	(Zones assigned to OUT3)	
	37.	Output OUT4	(Output OUT4 programming)	
	38.	OUT4 zones	(Zones assigned to OUT4)	
	39.	Output OUT5	(Output OUT5 programming)	
	40.	OUT5 zones	(Zones assigned to OUT5)	
	41.	Output OUT6	(Output OUT6 programming)	
	42.	OUT6 zones	(Zones assigned to OUT6)	

Monitoring	Report stations	43. MS1 tel.no.	(Monitoring station 1 telephone number)
		44. MS2 tel.no.	(Monitoring station 2 telephone number)
		45. MS1 format	(Monitoring station 1 transmission format)
		46. MS2 format	(Monitoring station 2 transmission format)
		47. Rep.options	(Reporting options)
	Identifiers	48. Zones ID MS1	(Zones events identifiers for station 1)
		49. Part.1 ID MS1	(Partition1 events identifiers for station 1)
		50. Part.2 ID MS1	(Partition2 events identifiers for station 1)
		51. Part.3 ID MS1	(Partition3 events identifiers for station 1)
		52. Part.4 ID MS1	(Partition4 events identifiers for station 1)
		53. Syst. ID MS1	(System events identifiers for station 1)
		54. Zones ID MS2	(Zones events identifiers for station 2)
		55. Part.1 ID MS2	(Partition1 events identifiers for station 2)
		56. Part.2 ID MS2	(Partition2 events identifiers for station 2)
		57. Part.3 ID MS2	(Partition3 events identifiers for station 2)
		58. Part.4 ID MS2	(Partition4 events identifiers for station 2)
		59. Syst. ID MS2	(System events identifiers for station 2)
	138. VISIN.addr.	(VISONIC radio system address)	
	139. VISON.test	(Test transmission period, VISONIC)	
	Zone rep.codes	60. Zone alarm	
		61. Zone tamper	
		62. Zone trouble	
		63. Zone violat.	(Zone violation)
		64. Zone restore	
		65. Tamper rest.	(Tamper restore)
		66. Trouble res.	(Trouble restore)
		134. Bypass	(Zones bypass)
		135. Unbypass	(Zones unbypass)
		67. MS1 assignm.	(Events assignment to station 1)
	68. MS2 assignm.	(Events assignment to station 2)	
	Part.rep.codes	69. Part.1 codes	(Partition 1 events codes)
		70. Part.2 codes	(Partition 2 events codes)
		71. Part.3 codes	(Partition 3 events codes)
		72. Part.4 codes	(Partition 4 events codes)
		73. Part.1→MS1	(Partition 1 events assignment to st. 1)
		74. Part.2→MS1	(Partition 2 events assignment to st. 1)
		75. Part.3→MS1	(Partition 3 events assignment to st. 1)
		76. Part.4→MS1	(Partition 4 events assignment to st. 1)
		77. Part.1→MS2	(Partition 1 events assignment to st. 2)
		78. Part.2→MS2	(Partition 2 events assignment to st. 2)
		79. Part.3→MS2	(Partition 3 events assignment to st. 2)
	80. Part.4→MS2	(Partition 4 events assignment to st. 2)	
	Syst.rep.codes	81. Sys.cds.set1	(System events codes set 1)
		82. Sys.cds.set2	(System events codes set 2)
		83. Sys.cds→MS1	(System events assignment to station 1)
		84. Sys.cds→MS2	(System events assignment to station 2)
		85. Tr. test. at	(Sending of test transmission at...)
86. AC loss del.		(AC loss report delay)	
126. Guard codes		(Guard control report codes)	
133. T. tst. every	(Test transmission every...)		
136. TELIM prefx	(Prefixes for extension of identifiers in TELIM transmission format)		
137. TELIM codes	(Codes to be send in TELIM transmission format)		

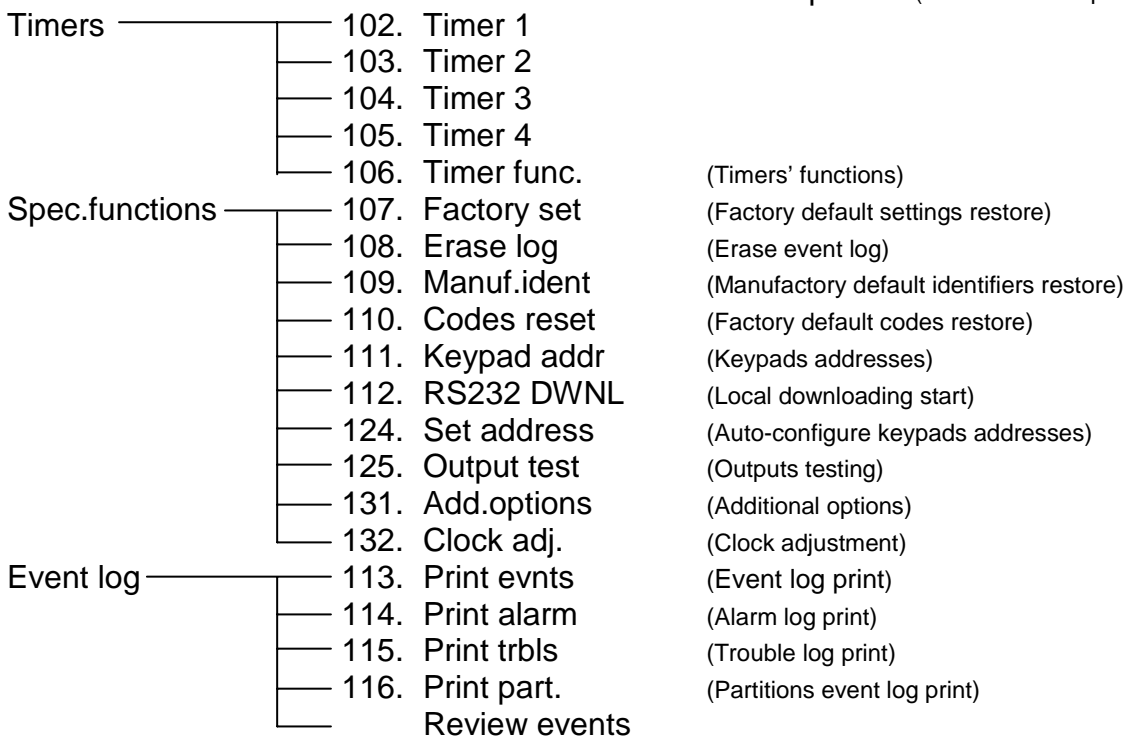
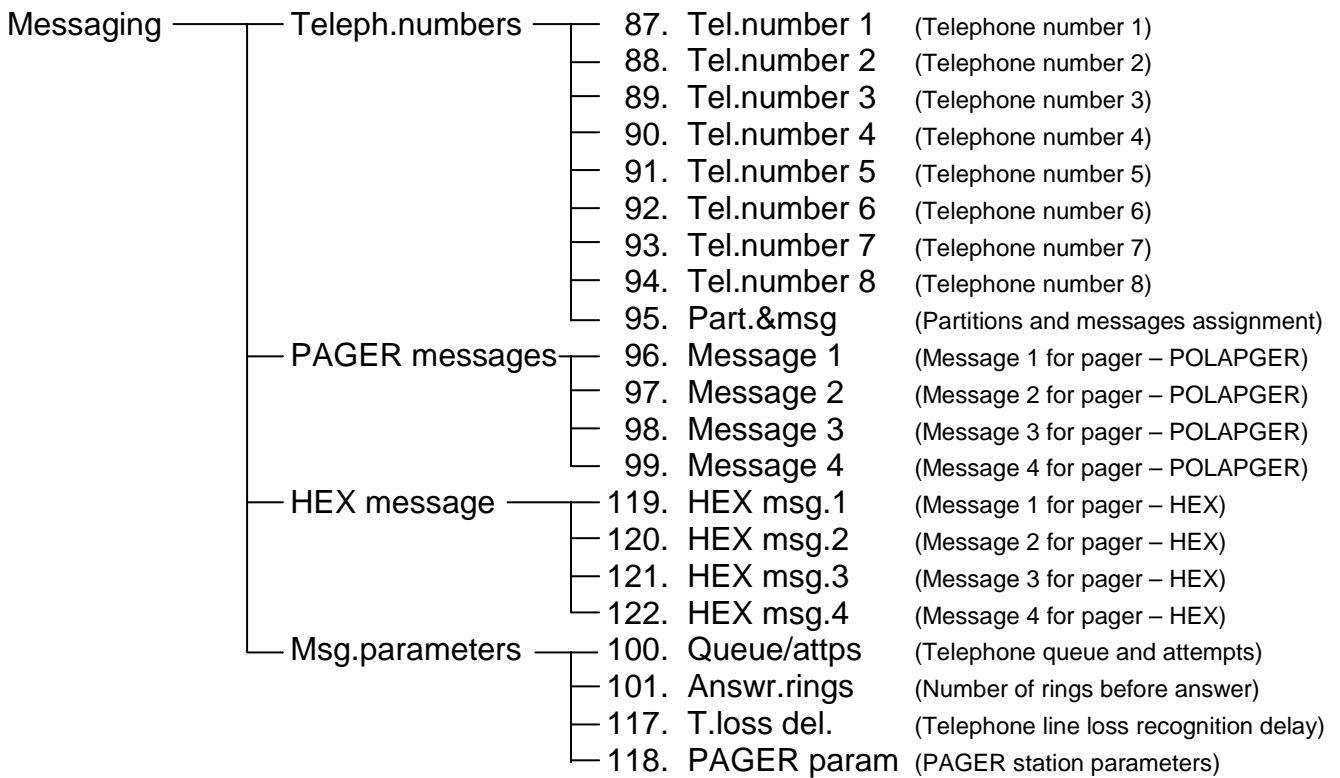

LCD keypad menu (see "LCD keypad service functions")

0 Quit service

Programming the service functions by means of keypad

In the LED keypads, the parameters being programmed are indicated with LEDs. In the LCD keypads, the parameters being programmed are shown on the display. The way of programming and data display in the keypad depend on the type of data entered with the service function. The panel programming is based on three types of functions: bit (BIT), decimal (DEC) and hexadecimal (HEX). The bit functions are used to program two-state parameters: YES and NO (e.g. the functions of zone assignment to partition, options). The decimal functions are used for programming data in the form of a few digits (for example, the test transmission time - 4 digits, individual entry delay time of zones - 16 x 2 digits). The hexadecimal functions are used to program hexadecimal data (e.g., monitoring codes).

BIT functions in the LED keypads

During programming with a bit function, the LEDs 1 to 8 show the current setting of particular parameters (diode on - YES, off - NO). Pressing one of the keys [1] to [8] changes the state of the corresponding diode. Having programmed 8 options, save them in the control panel using the [#] key. If the programming function includes more parameters, the control panel will signal with two short beeps acceptance of the first eight parameters, then it will go to the next set of options, displaying their status on the LEDs 1 to 8. By means of the LEDs 9 to 12, the panel will show which set of options is currently being programmed. When all the parameters have been programmed, the control panel will signal exiting the function with four short a one long beeps.

The [*] key makes it possible to quit the function at any time without saving the changes in currently displayed data.

BIT functions in the LCD keypads

After a bit function is called, the keys ◀ ▶ will change the cursor position and the keys ▲ ▼ will the value of the bit at the cursor position. It is also possible to enter the desired bit number with the numeric keys. Bit numbers 10-16 are entered by pressing [*] followed by the key with the second digit. The combination of [*] and [#] terminates the function.

BIT functions with a list in the LCD keypads

After a bit function with a list is called in the first line of the display the function name will be shown, while in the second line the first position in the bit switch list is displayed (e.g. System options). The character **Y** indicates that the option is on. To change the switch state press any numeric key. The keys ▲ ▼ will scroll the switch list. The [*] key makes it possible to quit the function at any time without saving the changes.

DEC functions in the LED keypads

During programming with a decimal function the LEDs 1-4 show binary the first digit, LEDs 5-8 - the second digit, while the LEDs 9-12 display binary the counter of digit pairs (see figure 1). The programming consists in entering a two-digit number and confirming it with the [#] key. **Make sure that the entered data are correct, because the control panel does not verify the input parameters and programming any wrong settings may result in malfunction of the panel.** The control panel will confirm acceptance of the data with two short beeps. When all the parameters have been programmed, the function is exited which is signaled with four short and one long beeps.

The [*] key makes it possible to quit the function at any time without saving the changes in currently displayed data.

DEC functions in the LCD keypads

In the case of functions which are used to program several parameters the keys ▲▼ choose the parameter to be modified, the key ◀ deletes the character which proceeds the cursor and the key ▶ cancel any changes to the currently edited parameter. Parameter values are entered with numeric keys. The [*] key makes it possible to quit the function at any time without saving the changes.

HEX functions in the LED keypads

During programming with a hexadecimal function, the LEDs 1-4 show binary the first HEX digit, LEDs 5-8 - the second digit, while the LEDs 9-12 display the counter of digit pairs (see figure 1).

Programming by means of this type of function consists in entering a parameter (two hexadecimal digits) and confirming it with the [#] key. For the digits 0-9 it is sufficient to press the corresponding key, the digits A-F are entered using the combination of keys [*] and [0]-[5] (i.e. A=[*][0], B=[*][1] etc.). Pressing the [*] key results in blinking of the digit, which will be changed after one of the keys [0]-[5] is pressed.

The [*][#] combination of keys makes it possible to exit the function without saving the changes in the currently displayed data.

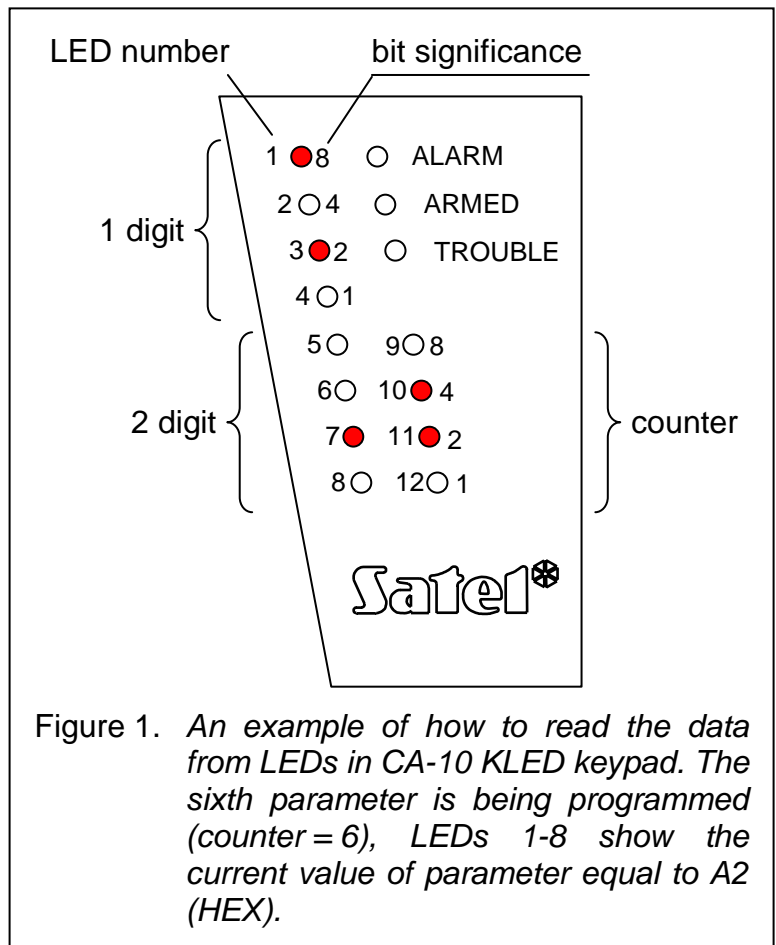

Note: In the LED keypad both in the decimal and hexadecimal function, consecutive depressions of numeric keys result only in displaying the respective number on the LEDs (the state of LEDs 1-4 and 5-8 is alternately changed). Only by pressing the [#] key you will save the status of the parameter displayed on the diodes .

HEX functions in the LCD keypads

Programming the two-digit hexadecimal HEX codes (e.g. the codes of zone events) by means of the functions FS60 - FS66 and FS134 - FS135 is performed in the same way as described for the decimal codes, the characters A ... F being reached with the key combination of [*] and one of the digits 0 ... 5.

When programming the multi-digit hexadecimal codes (e.g. identifiers in the functions FS48 - FS59), the keys ◀ and ▶ are used to move the cursor, the key ▲ deletes characters preceding the cursor, and the key ▼ toggles the mode from inserting characters to overwriting them, and vice versa. The new values are entered by means of the numeric keys, the characters A ... F being reached with the key combination of [*] and one of the digits 0 ... 5.

The key combination [*][#] makes it possible to quit the function without saving any changes.

Table of character coding for LED keypads

Decimal format (DEC)	Binary format (BIN)	Hexadecimal format (HEX)	State of LEDs 1-4 or 5-8
0	0000	0	○○○○
1	0001	1	○○○◎
2	0010	2	○○◎○
3	0011	3	○○◎◎
4	0100	4	○◎○○
5	0101	5	○◎○◎
6	0110	6	○◎◎○
7	0111	7	○◎◎◎
8	1000	8	◎○○○
9	1001	9	◎○○◎
10	1010	A	◎○◎○
11	1011	B	◎○◎◎
12	1100	C	◎◎○○
13	1101	D	◎◎○◎
14	1110	E	◎◎◎○
15	1111	F	◎◎◎◎

Editing texts in the LCD keypads

During programming of text format messages, the keys ◀ ▶ control the cursor, [*] toggles the mode (text mode / numeric mode) and [#] confirms the entire text value. The remaining keys function depend on the mode.

The text mode is signaled by * in the upper right corner of the display. Use numeric keys to enter characters according to the table. Lowercase characters are obtained by pressing the corresponding numeric key twice. To cancel programming a description, press sequentially [*] and [#] while in the numeric mode.

Key	Numeric mode function	Text mode function	
▲	delete proceeding character	previous character in the alphabet	
▼	toggle insert/overwrite	next character in the alphabet	
1	1	.	,
2	2	A	a
3	3	D	d
4	4	G	g
5	5	J	j
6	6	M	m
7	7	P	p
8	8	T	t
9	9	W	w
0	0	space	-

Description of the panel service functions

Shown in parentheses at many functions is information on the method of data input: bit (BIT), decimal (DEC) or hexadecimal (HEX). If the function description contains no detailed information on programming, the data are entered in the panel as described in the previous section for the specific type of function.

FS0 - quit service mode

The function ends the control panel operation in service mode. The control panel starts functioning in accordance with the new settings. Restart of all partitions is performed - if any keypad operations are carried out at this moment in another partition (e.g. if a user function has been activated), the panel will terminate the current function and enter the standby state. Exiting the service mode is signaled in all partitions with four short and one long beeps.

Functions programming basic options

FS1 - changing service code

The service access code enables activation of the service mode. It can be from 4 to 6 digits long.

EXAMPLE:

- changing the service code from 12345 to 78901
- [12345] [#] - enter the service code
 - [1] [#] - call the service function 1
 - [78901] [#] - enter the new code and confirm it; the function will be automatically exited.

FS2 - programming control panel identifier (HEX)

FS3 - programming computer identifier (HEX)

In the telephone DOWNLOADING mode (see: Installer Manual), the control panel, having established connection with the computer, sends a six-character panel identifier and waits for the identifier of the answering computer. When the appropriate identifier is received, the transmission to computer can begin.

In the LED keypad programming of this code consists in entering three pairs of hexadecimal characters (digits from 0 to 9 and characters A, B, C, D, E, F - see the table of codes). The LEDs will first display previous settings, and, after the change - the values of characters entered (binary, the first character - LEDs 1 to 4, the second - LEDs 5 to 8, number of pair of programmed characters - LEDs 9-12). When the last pair of characters has been entered and acknowledged, the control panel will automatically quit the function.

EXAMPLE (for the LED keypad):

programming the identifier 23C4D5

[2] [#] - call the required function.

[2][3] [#] - enter the two first characters

[*2][4] [#] - enter the two next characters

[*3][5] [#] - enter the two last characters; after acknowledging them the panel will automatically exit the function

FS4 - programming computer telephone number (HEX)

The computer telephone number is necessary so that the control panel can call the computer. **If the computer telephone number is not programmed, the computer initiated communication can be established in a simplified way - the control panel will not hang up and call back.**

The length of a telephone number can be up to sixteen digits and special characters. The special characters are used to control the dialing process. In the LED keypad it is programmed by entering the consecutive digits and characters in pairs. Each pair is to be confirmed by the [#] key (see the example below). The LEDs 9-12 show (in binary form) which pair of characters is being programmed, and the LEDs 1-4 and 5-8 show (also in binary form) the values of programmed digits.

EXAMPLE: programming the number 0 - 556 40 31 (0D 55 64 03 1AA)

[4] [#] - call the required function

[0][*3] [#] - enter the two first characters

[5][5] [#] - enter the two next characters

[6][4] [#] - enter the two next characters

[0][3] [#] - enter the two next characters

[1][*0] [#] - enter the next character and the part of special code AA (telephone number end)

[*0] [#] - enter the second part of special code AA (telephone number end)

[*] [#] - exit the function after entering 11 characters.

The following codes has been assigned to the functions mentioned below:

A(HEX) - control character	(combination [*][0])
B(HEX) - switch to pulse dialing	(combination [*][1])
C(HEX) - switch to tone dialing	(combination [*][2])
D(HEX) - wait for dialing tone	(combination [*][3])
E(HEX) - short pause (3 seconds)	(combination [*][4])
F(HEX) - long pause (10 seconds)	(combination [*][5])
*(HEX) - signal * in DTMF system	(combination A[0])
#(HEX) - signal # in DTMF system	(combination A[1])
a(HEX) - signal a in DTMF system	(combination A[2])
b(HEX) - signal b in DTMF system	(combination A[3])
c(HEX) - signal c in DTMF system	(combination A[4])
d(HEX) - signal d in DTMF system	(combination A[5])

Notes:

- **Do not program the control characters B, C and D before the telephone number (these are set in the FS5 options).**

- **In case of the busy signal, the waiting for dial tone (code D) does not decrease the counter of queues and retries** (e.g. when the panel is connected to an extension line and the outside line is busy, the panel will dial the number until it gets through. Only when the number has been dialed in full, the busy or no answer condition will change the counters).
- If shorter than 16 characters, the telephone number **must** be ended with the special code **AA** („AA” means end of number).
- Special signals generated in the DTMF system require two characters to be taken up in the telephone number (A and a corresponding digit).
- In the LCD keypad, the DTMF special signals are entered by programming the A character and a corresponding digit, according to the above meaning.

FS5 - programming the system options (BIT)

The function programs 24 options which determine how the control panel operates. In the LED keypad, they are grouped into three sets of 8 options each.

The tables below contain the following information:

- first column – number of option for LED keypads,
- second column – number of option for LCD keypads,
- third column - description of the option,
- fourth column - way in which the option is signaled in the LED keypad (by a LED with the number corresponding to that of the given option),
- fifth column - way in which the option is signaled in the LCD keypad (display or no display of **Y** mark).

FIRST SET OF OPTIONS (for LED keypad, the LED No. 12 is blinking)

Option No.		Option	Signaling	
LED	LCD		LED	LCD
1	1	telephone messaging on	ON	Y
		telephone messaging off	OFF	
2	2	monitoring on	ON	Y
		monitoring off	OFF	
3	3	call answering on	ON	Y
		call answering off	OFF	
4	4	printing on	ON	Y
		printing off	OFF	
5	5	CR+LF mode (printer) on	ON	Y
		CR+LF mode off	OFF	
6	6	transmission rate to printer 2400 Bps (RS-232)	ON	Y
		transmission rate to printer 1200 Bps	OFF	
7	7	transmission to printer with parity (RS-232)	ON	Y
		transmission without parity	OFF	
8	8	transmission to printer with EVEN parity	ON	Y
		transmission with ODD parity	OFF	

Note: The options 4 to 8 of the first set refer to the control panel operation with a printer.

SECOND SET OF OPTIONS (for LED keypad, the LED No. 11 is blinking)

Option No.		Option	Signaling	
LED	LCD		LED	LCD
1	9	external DOWNLOADING enabled	ON	Y
		external DOWNLOADING disabled	OFF	
2	A	TONE dialing	ON	Y
		PULSE dialing	OFF	
3	B	double playback of alarm message from synthesizer	ON	Y
		single playback of alarm message	OFF	
4	C	GROUND-START signal generated before dialing (special tel. line service)	ON	Y
		GROUND-START signal blocked	OFF	
5	D	no dial tone test before dialing the number	ON	Y
		dialer waits for dial tone before dialing the number	OFF	
6	E	no answer test (synthesizer message emitted 15 seconds after dialing the number)	ON	Y
		call answer test activated (the dialer will send the message after detecting the call answer)	OFF	
7	F	OUT5, OUT6 outputs control the radio messaging (NOKTON)	ON	Y
		OUT5, OUT6 outputs perform their assigned functions	OFF	
8	G	double call to answer	ON	Y
		single call to answer	OFF	

THIRD SET OF OPTIONS (for LED keypad, the LED Nos. 11, 12 are blinking)

Option No.		Option	Signaling	
LED	LCD		LED	LCD
1	H	service mode unavailable if any partition is armed	ON	Y
		service mode always available	OFF	
2	I	communication with the computer unavailable if any partition is armed	ON	Y
		communication with the computer always available	OFF	
3	J	alarm if zones are violated after the exit delay elapses	ON	Y
		control panel does not alarm if zones in a partition are violated after the exit delay elapses	OFF	
4	K	fire alarm signaled only in partition where it was activated	ON	Y
		fire alarm signaled in all partitions	OFF	
5	L	keypad alarm (PANIC, AUX, TAMPER) signaled only in partition where it was activated	ON	Y
		keypad alarm signaled in all partitions	OFF	
6	M	<u>in case of problems with transmission to the station</u> monitoring suspended until occurrence of a new event	ON	Y
		monitoring suspended for 30 min	OFF	
7	N	OUT5 and OUT6 outputs work in „UA” format	ON	Y
		OUT5 and OUT6 outputs work in PC16OUT format (options 7, 8 deactivated)	OFF	

8	O	OUT5 and OUT6 outputs work in „LV&BY” format	ON	<input checked="" type="checkbox"/>
		OUT5 and OUT6 outputs work in PC16OUT format (options 7, 8 deactivated)	OFF	<input type="checkbox"/>

Note: Options 7 and 8 of the third set are only relevant with activated option 7 of the second set – „outputs OUT5, OUT6 control NOKTON radio messaging”.

FS6 - programming the global times (DEC)

The settings refer to the entry delay, exit delay and alarm time. The times are valid for the entries and exits to which no individual times are assigned. **The exit delay time is common for all partitions.** The alarm time programmed in this function refers also to the keypad alarm signaling.

Note: The alarm time set with the function FS6 defines also the zone alarms cut-off time - when the alarm is on, the subsequent zone violations will not trigger consecutive alarms until the cut-off time has elapsed.

The time values are programmed within the range from 1 to 99 seconds.

In the LED type keypads, the values of entry time, exit time and alarm time are entered in turn by two digits.

EXAMPLE (for the LED keypad):

- programming the times: entry delay=30s, exit delay=60s, alarm=90s
- [6] [#] - call the required function
 - [3][0] [#] - enter the entry delay time (two digits) – the LED 12 is blinking
 - [6][0] [#] - enter the exit delay time (two digits) – LED 11 is blinking
 - [9][0] [#] - enter the alarm time - the LEDs 11,12 are blinking - after acknowledging the last time, the control panel automatically exits the function.

When programming from the LCD keypad, pressing the [#] key confirms all the three times entered.

FS7 - programming the counting zone counters (DEC)

The control panel is equipped with three independent violation counters which can be associated with any zones. Violation of these zones will trigger alarm after the programmed number of violations is exceeded in the respective zone counter. Each counter can sum up violations of one or several zones defined as the counting ones (e.g. the counter 1 can count violations of zone 2, the counter 2 - violations of zones 4, 5, 6). The alarm will be generated by the zone which has been violated as the last one.

Three counter values are programmed, from 01 to 07, in the following order: counter 1, counter 2, counter 3. If no counting zones are provided in the panel, the programmed values are irrelevant.

- Number „0” programmed – alarm after 8 violations.
- Number „1” programmed – alarm after the second violation.
- Number „2” or higher programmed – alarm after the number of violations equal to the value programmed.

Time gates corresponding to the counters are programmed in FS123.

EXAMPLE (for LED keypad):

- programming the counters: the 1st - 2 violations, the 2nd - 5 violations, the 3rd - not used
- [7] [#] - call the function
 - [0][2] [#] - program the first counter (the lower LED B is blinking)
 - [0][5] [#] - program the second counter (the lower LED A is blinking)
 - [*] - exit the function - programming of the third counter is omitted

Functions programming partition assignment

FS8 - zones assignment to partition 1 (BIT)

FS9 - zones assignment to partition 2 (BIT)

FS10 - zones assignment to partition 3 (BIT)

FS11 - zones assignment to partition 4 (BIT)

The functions FS8 - FS11 are used to divide the alarm system into partitions. Description of the control panel division into partitions - see the Installer Manual.

In the LED keypads, the zones are assigned to a partition in two stages. In the first stage (LED 12 blinking), the zones from 1 to 8 are programmed, in the second stage (LED 11 blinking), the zones from 9 to 16 are programmed (LED 1 indicates then zone 9, LED 2 - zone 10, etc.). You can proceed to the second stage by pressing the key [#]. Assignment of the zones to a partition is effected by pressing the keys from 1 to 8 and indicated by lighting of the LED representing the particular zone. Having programmed all the zones, press the key [#] to save the entered data and quit the function.

In the LCD keypads, the zones can be assigned to partitions by entering the corresponding zone number (zones 1-9 by pressing the numeric key, zones 10-16 by pressing, in turn, the key [*] and the numeric key from 0 to 6, zones 10-16 being displayed by means of letters A to G), or using the arrow keys (arrows ◀ and ▶ enable movement of the cursor, arrow ▼ assigns a zone to or deletes a zone from partition, while arrow ▲ displays the name of zone selected by the cursor). Pressing the key [#] will result in saving the entered data and quitting the function.

FS12 - programming zones displayed in partition 1 keypad (BIT)

FS13 - programming zones displayed in partition 2 keypad (BIT)

FS14 - programming zones displayed in partition 3 keypad (BIT)

FS15 - programming zones displayed in partition 4 keypad (BIT)

Provision is made in the control panel for optional selection of the zones to be displayed in the given keypad. This option refers mainly to the LED keypads (in the LCD keypads, the functioning of this option is limited to the mode of LED standard display). The CA-10 KLED keypad make it possible to display the status of 12 out of 16 zones, the other LED keypads status of all zones. The zones which are to be shown in the keypad are displayed in the ascending order, while the zones which are not to be shown are skipped. For example, if the zones 2, 3, 5 and 7 are selected for display in the keypad, the status of zone 2 is displayed on the first LED, zone 3 status - on the second, zone 5 - on the third, zone 7 - on the fourth, while the other LEDs will remain unused.

The programming is similar to that in FS8 - FS11 (zones assignment to partition).

FS16 - programming auto-bypassed zones in partition 1 (BIT)

FS17 - programming auto-bypassed zones in partition 2 (BIT)

FS18 - programming auto-bypassed zones in partition 3 (BIT)

FS19 - programming auto-bypassed zones in partition 4 (BIT)

The functions 16 to 19 apply to the zones which are automatically bypassed after silent or loud arming with the authority level 7 code (partial arming). The programming is similar to that in FS8 – FS11.

Note: The zones to be bypassed at no exit from the partition are programmed with the service functions FS 127÷130 (EXIT-BYPASS).

FS20 - programming partition 1 options (BIT)

In order to increase flexibility of the system, some functions of the keypads are optional. They are performed by the CA10 control panel only in partitions, where they are not disabled. Two sets of options are programmed for each partition. The first set (LED 12 blinking) defines availability of the functions activated by holding down one key. The other set (LED 11 blinking) defines which audible signals are generated by the partition keypad.

The options selected for each set should be confirmed with the [#] key.

Note: The options 1,2 & 3 of the first set in the service functions FS20 to FS23 refer to the LED keypads and are irrelevant, when LCD keypads only are installed in the system. To enable GOTO function for the LCD keypads, settings must be separately programmed in the keypad itself (see: →Keypad Service Functions →Settings →Function GOTO).

FIRST SET OF OPTIONS (for LED keypad, the LED No. 12 is blinking)

Option No.		Option	Signaling	
LED	LCD		LED	LCD
1	1	function GOTO Partition 2 disabled	ON	Y
		function GOTO Partition 2 enabled	OFF	
2	2	function GOTO Partition 3 disabled	ON	Y
		function GOTO Partition 3 enabled	OFF	
3	3	function GOTO Partition 4 disabled	ON	Y
		function GOTO Partition 4 enabled	OFF	
4	4	quick arming [0][#] disabled	ON	Y
		quick arming [0][#] enabled	OFF	
5	5	3 wrong codes alarm disabled	ON	Y
		3 wrong codes alarm enabled	OFF	
6	6	keypad PANIC alarm disabled	ON	Y
		keypad PANIC alarm enabled	OFF	
7	7	keypad AUX alarm disabled	ON	Y
		keypad AUX alarm enabled	OFF	
8	8	keypad FIRE alarm disabled	ON	Y
		keypad FIRE alarm enabled	OFF	

SECOND SET OF OPTIONS (for LED keypad, the LED No. 11 is blinking)

Option No.		Option	Signaling	
LED	LCD		LED	LCD
1	9	keypad alarm signal until cleared on	ON	Y
		keypad alarm signal until cleared off	OFF	
2	A	alarm signal for the global alarm time on	ON	Y
		alarm signal for the global alarm time off	OFF	

3	B	DAY/NIGHT or COUNTING zone violation signaled in keypad (5 long beeps)	ON	Y
		no DAY/NIGHT or COUNTING zone violation signaled in keypad	OFF	
4	C	CHIME signal on (five short beeps)	ON	Y
		CHIME signal off	OFF	
5	D	trouble signal on (two short beeps every 3 seconds)	ON	Y
		trouble signal in keypad off	OFF	
6	E	EXIT DELAY signal on (one long beep every three seconds)	ON	Y
		EXIT DELAY signal off	OFF	
7	F	ENTRY DELAY signal on (one sort beep every three seconds)	ON	Y
		ENTRY DELAY signal off	OFF	
8	G	key pressed signal on	ON	Y
		no key pressed signal	OFF	

Note: If the first two options of the second set are activated at the same time, the first option will have priority, i.e. the keypad alarm will be signaled until cleared.

FS21 - programming partition 2 options (BIT)

The function defines which functions are available in the partition 2 keypad and which events are signaled acoustically.

FIRST SET OF OPTIONS (for LED keypad, the LED No. 12 is blinking)

Option No.		Option	Signaling	
LED	LCD		LED	LCD
1	1	function GOTO Partition 1 disabled	ON	Y
		function GOTO Partition 1 enabled	OFF	
2	2	function GOTO Partition 3 disabled	ON	Y
		function GOTO Partition 3 enabled	OFF	
3	3	function GOTO Partition 4 disabled	ON	Y
		function GOTO Partition 4 enabled	OFF	

The other options as in FS20.

FS22 - programming partition 3 options (BIT)

The function defines which functions are available in the partition 3 keypad and which events are signaled acoustically.

FIRST SET OF OPTIONS (for LED keypad, the LED No. 12 is blinking)

Option No.		Option	Signaling	
LED	LCD		LED	LCD
1	1	function GOTO Partition 1 disabled	ON	Y
		function GOTO Partition 1 enabled	OFF	
2	2	function GOTO Partition 2 disabled	ON	Y
		function GOTO Partition 2 enabled	OFF	
3	3	function GOTO Partition 4 disabled	ON	Y
		function GOTO Partition 4 enabled	OFF	

The other options as in FS20.

FS23 - programming partition 4 options (BIT)

The function defines which functions are available in the partition 4 keypad and which events are signaled acoustically.

FIRST SET OF OPTIONS (for LED keypad, the LED No. 12 is blinking)

Option No.		Option	Signaling	
LED	LCD		LED	LCD
1	1	function GOTO Partition 1 disabled	ON	Y
		function GOTO Partition 1 enabled	OFF	
2	2	function GOTO Partition 2 disabled	ON	Y
		function GOTO Partition 2 enabled	OFF	
3	3	function GOTO Partition 3 disabled	ON	Y
		function GOTO Partition 3 enabled	OFF	

The other options as in FS20.

Functions programming zone parameters

FS24 - programming zone sensitivity

Each zone of the CA-10 panel can have its individual reaction time. Violations lasting shorter than the programmed reaction time are disregarded by the panel.

Programming the zone sensitivity in the LED keypad is carried out in a different way than programming the other parameters. The value from 1 to 255 is programmed, which corresponds to the times of 0.016 sec. do 4.08 sec. by the formula:

$$\text{REACTION TIME} = \text{PROGRAMMED VALUE} \times 0.016 \text{ sec.}$$

When one, two or three digits are entered for the first zone and confirmed with the key [#], the control panel will proceed to programming the next zone reaction time. After the last parameter is entered and confirmed, the control panel quits the function. The LEDs 9 to 12 indicate in binary form the zone the parameter refers to (for zones 1-15 binary – see: Table of character coding for LED keypads; for zone 16 LEDs 9-12 are off). On the LEDs 1 to 8, the panel displays the previously programmed parameter setting in the binary form.

The programming can be interrupted by using the [*] key.

EXAMPLE

- changing the reaction time of zones 1, 3 and 6 to 0.8 s, zone 8 to 0.1 s, the other zones unchanged
- 0.8s/0.016s = 50 (enter the same value for zones 1,3 and 6)
- 0.1s/0.016s = 6.25 (enter 6 for zone 8, which will ensure the reaction time = 0.096s)
- [2][4] [#] - call the function
- [5][0] [#] - reaction time for the first zone (LEDs 9-12 = 0001)
- [#] - confirm the second zone time (LEDs 9-12 = 0010)
- [5][0] [#] - reaction time for the third zone (LEDs 9-12 = 0011)
- [#] - confirm the fourth zone time (LEDs 9-12 = 0100)
- [#] - confirm the fifth zone time (LEDs 9-12 = 0101)
- [5][0] [#] - reaction time for the sixth zone (LEDs 9-12 = 0110)
- [#] - confirm the seventh zone time (LEDs 9-12 = 0111)
- [6] [#] - reaction time for the eighth zone (LEDs 9-12 = 1000)
- [*] - quit the function (LEDs 9-12 = 1001) (because the other zones remain unchanged)

In the LCD keypad, the time is programmed directly in milliseconds from 16 to 4080 (the value is automatically rounded up to the multiple of the number 16).

By default, all the zones have the same reaction time (0.48 sec). In most cases, no change of the time setting will be required.

The function is intended for advanced installers. It allows the zone sensitivity to be selected where special detectors are used (for example, mechanical detectors of broken glass, or low hysteresis detectors, not fitted with univibrator at the output).

Note: *The minimum sensitivity of the keypad zones and expander zones is 64ms (4 x 0.016sec.). The actual sensitivity values of these zones can amount to $n \times 64ms$ ($n=1,2,3,\dots$). This results from the way the keypad is handled by the control panel – the status of these zones is read out at intervals of exactly 64ms.*

FS25 - programming zone type (DEC)

Selection of the zone type depends on the type of detector, as well as configuration of its connection to the control panel. The following types of detectors and configuration are possible: NC, NO, EOL, 2EOL/NC, 2EOL/NO. Determination of the type of detector and configuration is necessary, since interpretation of information received by the control panel will depend on it. For example, an open zone can mean correct state of the NO detector or violation of the NC (or EOL) detector, as well as tamper violation in the case of 2EOL configuration.

Programming in the LED keypad consists in entering the suitable two-digit number (to determine the detector type and configuration) for the particular zones. Having confirmed the detector type and configuration for one zone, the control panel proceeds to programming the next type of zone, until particular detector types and configuration are assigned to all 16 zones. The following numbers are correct:

- 00 - no detector (for not used zones)
- 01 - NC detector (normally closed)
- 02 - NO detector (normally open)
- 03 - EOL detector (End Of Line Resistors - default value)
- 04 - 2EOL/NC detector (Double End Of Line Resistors – NC detector)
- 05 - 2EOL/NO detector (Double End Of Line Resistors – NO detector)

During the programming, the control panel will display the current parameter setting (in binary form) on the LEDs 1 to 8. The LEDs 9 to 12 indicate the zone for which the detector type is being programmed. (for zones 1-15 binary – see: Table of character coding for LED keypads; for zone 16 LEDs 9-12 are off)

EXAMPLE:

	programming the EOL type zones 1 do 6, NC type zones 7 to 8, the other zones (13 to 16) not used	
[2][5] [#]	- call the function	
[0][3] [#]	- detector type for the first zone	(LEDs 9-12 = 0001)
[0][3] [#]	- detector type for the second zone	(LEDs 9-12 = 0010)
[0][3] [#]	- detector type for the third zone	(LEDs 9-12 = 0011)
[0][3] [#]	- detector type for the fourth zone	(LEDs 9-12 = 0100)
[0][3] [#]	- detector type for the fifth zone	(LEDs 9-12 = 0101)
[0][3] [#]	- detector type for the sixth zone	(LEDs 9-12 = 0110)
[0][1] [#]	- detector type for the seventh zone	(LEDs 9-12 = 0111)
[0][1] [#]	- detector type for the eighth zone	(LEDs 9-12 = 1000)
[0][1] [#]	- detector type for the ninth zone	(LEDs 9-12 = 1001)
[0][1] [#]	- detector type for the tenth zone	(LEDs 9-12 = 1010)
[0][1] [#]	- detector type for the eleventh zone	(LEDs 9-12 = 1011)
[0][1] [#]	- detector type for the twelfth zone	(LEDs 9-12 = 1100)
[0][0] [#]	- no detector on zone 13	(LEDs 9-12 = 1101)
[0][0] [#]	- no detector on zone 14	(LEDs 9-12 = 1110)
[0][0] [#]	- no detector on zone 15	(LEDs 9-12 = 1111)

[0][0] [#] - no detector on zone 16

(LEDs 9-12 = 0000)

In LCD keypads, two ways of programming the zone type are possible: by pressing the keys from 0 to 5 (0 - no detector; 1 - NC; 2 - NO; 3 - 2EOL; 4 - 2EOL/NC; 5 - 2EOL/NO) or by means of the keys ◀ and ▶, which make possible scrolling through the zone type lists. The keys ▲ and ▼ enable the subsequent zones to be scrolled. Having programmed the zone type for all zones, confirm them by pressing the key [#], which is equivalent to quitting the function. Suspension of the programming is possible by pressing the [*] key.

FS26 - programming zone reaction type (DEC)

The control panel reaction to a zone violation depends on the function assigned to the given zone (e.g., the reaction will be different in the case of 24 H FIRE zone violation, and in the case of ARMING zone violation).

The programming consists in entering an appropriate two-digit number for each zone to determine its reaction type. Each of the CA-10 zones can be programmed for:

- 00 - ENTRY/EXIT
- 01 - DELAY
- 02 - INTERIOR DELAY
- 03 - INSTANT
- 04 - DAY/NIGHT
- 05 - COUNTING L1
- 06 - COUNTING L2
- 07 - COUNTING L3
- 08 - 24H AUDIBLE
- 09 - 24H AUXILIARY
- 10 - 24H SILENT
- 11 - 24H FIRE
- 12 - ARMING
- 13 - SILENT ARMING
- 14 - DISARMING
- 15 - NO ALARM ACTION
- 16 - ARMING/DISARMING
- 17 - DELAY AUDIBLE
- 18 - AUTOMATIC BYPASS ARMING
- 19 - PERIMETER
- 20 - ENTRY/EXIT-FINAL

Both in the LED and LCD keypads, the programming consists in entering for each zone an appropriate two-digit number, which determines the zone reaction type. In the LCD keypads, setting the zone reaction type is also possible by means of the keys ◀ and ▶, which scroll the reaction type list. The keys ▲ and ▼ enable the next zones to be scrolled.

FS27 - programming zone options (BIT)

Each control panel zone has eight associated options which activate additional functions of the zone. The use of these options depends on the zone reaction type. The control panel tests only the options relevant to the given zone. For example, it is of no use to activate the "auto-bypassed after first alarm" option or the "must not be violated on arming" option for the ARMING zones. Activation of such options has no effect on the zone functioning.

Option No.		Option	Signaling	
LED	LCD		LED	LCD
1	1	PRIORITY (may not be violated on arming)	ON	Y
		may be violated on arming	OFF	
2	2	CHIME (generates chime signal when disarmed)	ON	Y
		generates no chime signal	OFF	
3	3	AUTO-RESET 1 (auto-bypassed after first alarm)	ON	Y
		always alarms (when both options 3 and 4 are off)	OFF	
4	4	AUTO-RESET 3 (auto-bypassed after third alarm)	ON	Y
		always alarms (when both options 3 and 4 are off)	OFF	
5	5	ABORT DELAY (no violation code reported to monitoring station during "entry delay")	ON	Y
		violation code reported during "entry delay"	OFF	
6	6	POWER UP DELAY (zone not supervised for 120 s after control panel power-up)	ON	Y
		zone supervised immediately after power-up	OFF	
7	7	RESTORE AFTER BELL (zone violation restore code reported to monitoring station after alarm ends)	ON	Y
		zone violation restore code reported to monitoring station immediately (with option 8 also off)	OFF	
8	8	RESTORE AFTER DISARM (zone restore code reported to monitoring station after disarming)	ON	Y
		zone restore code reported immediately (with option 7 also off)	OFF	

During programming, in the LED keypad the LEDs 9 to 12 show binary the number of zone for which the options are being programmed.

Note: By default, the option no.1 is active for all the zones, which means that none of the zones may be violated during arming.

FS28 - programming individual entry delay (DEC)

An individual "entry delay time" (alarm delay) can be programmed for each zone.

The individual entry delays should **only be programmed where different delay times are required for the particular zones**. Otherwise, these times should be equal to zero, and the delay is programmed in **FS6**.

The programming consists in entering the times for delayed zones from 00 (then the global time specified in FS6 is valid) to 99 seconds.

The programmed times only refer to the zones programmed for ENTRY/EXIT, DELAY, INTERIOR DELAY and DELAY AUDIBLE.

EXAMPLE: (for LED keypad)

- programming the entry delay time (alarm delay) for the following zones: zone 4 - delay 30s, zone 7 - delay 45s, zone 8 - delay 60s.
- [2][8] [#] - call the function
- [#] - skip programming entry delay for zone 1
- [#] - skip programming entry delay for zone 2
- [#] - skip programming entry delay for zone 3
- [3][0] [#] - program the entry delay for zone 4
- [#] - skip programming entry delay for zone 5
- [#] - skip programming entry delay for zone 6

- [4][5] [#] - program the entry delay for zone 7
- [6][0] [#] - program the entry delay for zone 8
- [*] - exit the function - omit programming entry delay for the other zones

FS29 - programming maximum zone violation times

The FS29 function defines the boundary value of zone violation time which cannot be exceeded, unless the zone detector is faulty. Information on the trouble is recorded in the control panel event log and sent to the monitoring station. It can also be signaled on the output selected for ZONE TROUBLE.

The programming procedure is similar to that in the FS24 function (programming the zone sensitivity).

The violation time is set within the range of 0 to 255 seconds. When time 0 has been programmed, the function is inactive.

EXAMPLE: (for LED keypad)

- programming the maximum violation time for the zones 2 (60 seconds) and 4 (180 seconds)
- [2][9] [#] - call the function
- [0] [#] - disable the trouble check for the zone 1 (by default, the trouble check for all zones is disabled, so you can skip the zones for which this parameter is not programmed, by pressing the [#] key)
- [6][0] [#] - set the time for the zone 2
- [#] - skip programming the zone 3
- [1][8][0] [#] - set the time for the zone 4
- [*] - quit the function - skip time programming for the other zones.

Note: The violation time is only checked for the "alarm zones" (reaction type from 00 to 11).

FS30 - programming the zone no violation time

This function defines the time after which the absence of a given zone violation will be recognized by the panel as a trouble condition (e.g. a faulty or obstructed detector). The time of no violation is only counted when the zone is disarmed.

Information on the zone trouble is saved in the event log, and can be sent to the monitoring station and to the output selected for ZONE TROUBLE.

This parameter can be defined individually for each zone in the same way as in the FS29, within the range of 0 to 255 hours. Having programmed 0 means that the zone no violation time monitoring is disabled.

Note: The no violation time is only checked for the "alarm zones" (reaction type from 00 to 11).

Functions programming output parameters

FS31 - programming OUT1 output

The function makes it possible to define basic parameters regarding the OUT1 output:

- **output type** (determines in which conditions the output will be activated),
- **output operation time**,
- **operation options** (e.g., "polarity").

In the LED keypad, after selecting the function, the LEDs 1 to 8 show the respective parameter setting, while the LEDs 9 to 12 show which parameter is being programmed.

The first parameter defines the **output type** (the LED 12 is blinking). The programming consists in entering a two-digit number (identically as in the DEC functions) and confirming it with the [#] key.

Each of the outputs can be assigned any type from the following list:

- 00 - NOT USED
- 01 - BURGLARY ALARM
- 02 - FIRE/BURGLARY ALARM
- 03 - FIRE ALARM
- 04 - KEYPAD ALARM
- 05 - KEYPAD FIRE ALARM
- 06 - KEYPAD PANIC ALARM
- 07 - KEYPAD AUX. ALARM
- 08 - KEYPAD TAMPER ALARM
- 09 - DAY/NIGHT + COUNTING
- 10 - DURESS ALARM
- 11 - CHIME
- 12 - SWITCH MONO
- 13 - SWITCH BI (ON/OFF)
- 14 - ARM STATUS
- 15 - SILENT ARM STATUS
- 16 - EXIT DELAY STATUS
- 17 - ENTRY DELAY STATUS
- 18 - TELEPHONE USAGE STATUS
- 19 - GROUND START
- 20 - REPORT ACKNOWLEDGE
- 21 - BYPASS STATUS
- 22 - READY STATUS
- 23 - ZONE VIOLATION STATUS
- 24 - TELEPHONE LINE TROUBLE
- 25 - 230V AC LOSS INDICATOR
- 26 - BATTERY TROUBLE INDICATOR
- 27 - POWER SUPPLY
- 28 - FIRE DETECTORS POWER SUPPLY
- 29 - POWER SUPPLY WITH RESET FUNCTION
- 30 - TIMER
- 31 - AUDIBLE ARM STATUS
- 32 - FULL ARM STATUS
- 33 - ARM/DISARM/CLEAR ALARM
- 34 - KEYPAD BUZZER ALARM
- 35 - POWER SUPPLY ON ARMED MODE
- 36 - LED STATUS
- 37 - RELAY STATUS
- 38 - ZONE TROUBLE
- 39 - NO GUARD CODE
- 40 - SERVICE MODE STATUS
- 41 - BATTERY TEST RESULT

Output operation time is programmed from 00 to 99. A corresponding option (see below) defines whether the operation time has been given in seconds or minutes.

The set of eight options defines i.a. the output assignment to partitions, and other details of the output operation. The options are programmed in much the same way as the other BIT functions.

OUTPUT OPTIONS:

Option No.		Option	Signaling	
LED	LCD		LED	LCD
1	1	output assigned to partition 1	ON	Y
		output not assigned to partition 1	OFF	
2	2	output assigned to partition 2	ON	Y
		output not assigned to partition 2	OFF	
3	3	output assigned to partition 3	ON	Y
		output not assigned to partition 3	OFF	
4	4	output assigned to partition 4	ON	Y
		output not assigned to partition 4	OFF	
5	5	pulsating signal	ON	Y
		steady signal	OFF	
6	6	operation time in minutes	ON	Y
		operation time in seconds	OFF	
7	7	LATCH type output – signaling until cleared (operation time irrelevant)	ON	Y
		output operates periodically	OFF	
8	8	polarity +12V when the output is active	ON	Y
		polarity 0V when the output is active	OFF	

Note: The option of output assignment to a partition is to be used, when separate signaling devices have to be assigned to individual partitions. If not assigned to a partition, the alarm output will signal every alarm.

In the LED keypads, after selecting the function of output OUT1 programming, the LEDs 1 to 8 will show setting of the corresponding parameter, while the LEDs 9 to 12 will inform which parameter is being entered.

Setting the first parameter, i.e. the output function, is signaled by blinking of the LED 12. Programming the output function consists in entering a two-digit number (DEC), which corresponds to the function number, and confirming the selection with the key [#]. Then, the function proceeds automatically to programming the next parameter.

Entering the output operation time is signaled by blinking of the LED 11. The output operation time is set by entering a two-digit number from 00 to 99 (DEC). Remember that, when setting options at the next stage of programming, you should define, whether the operation time was indicated in seconds or in minutes. After setting the output operation time and confirming it with the key [#], the function will automatically proceed to programming the next parameter.

Setting the output options is signaled by blinking of the LEDs 11 and 12. The options are programmed in the same way as other bit functions (BIT), i.e. pressing the keys from 1 to 8 will activate or deactivate the option, which is signaled, respectively, by lighting or no lighting of the LEDs 1 to 8. The setting completed, confirmation of the options with the key [#] will exit the function.

EXAMPLE:

programming the OUT1 output for the BURGLARY/FIRE ALARM type operation, for 5 minutes, with polarity 0V in active state

- [3][1] [#] - call the function. The LEDs 1-8 will show number of current output type (LEDs 1-4 will show binary first digit, LEDs 5-8 second digit). The blinking LED 12 signals the output type being programmed.
- [0][2] [#] - enter and confirm the output number (the LED 12 starts blinking - operation time programming)
- [0][5] [#] - program and confirm the time (LEDs 11 and 12 start blinking - proceed to programming the output option)
- [6] - LED 6 goes on - the „time in minutes” option is activated
- [8] [#] - LED 8 goes off - set the "polarity" = 0V and exit the function.

In the LCD keypads, after selecting the function of output OUT1 programming, the menu will be displayed, which enables the output parameters to be set. Movement through the menu is possible by means of the arrow keys ▲ and ▼. The first parameter, i.e. the output function, is selected by means of the arrow keys ◀ and ▶, or by entering the two-digit function number (DEC). The second parameter, i.e. the output operation time, is determined by entering a two-digit number from 00 to 99 (DEC). Remember that, when setting options at the next stage of programming, you should define, whether the operation time was indicated in seconds or in minutes. The third parameter, i.e. the output options, is programmed by scrolling through the option list with the arrow keys ◀ and ▶ and toggling their status by means of any numeric key, which is indicated on the display by appearance/disappearance of the  flag at the given option. The setting completed, confirmation of the parameters with the key [#] will exit the function.

FS32 - programming list of zones OUT1 (BIT)

The function is used to program the output controlling zones. The selection of zones limits the output operation only to reaction to violation of those zones.

The zone selection should only be used when it is necessary to have separate signaling for events from a specific zone or a group of zones.

If no list of zones is indicated, the control panel will assume by default that the output reacts to events from any zone – for example, the BURGLARY alarm type output will signal alarms for each alarm zone in the control panel. Of course, the zone reaction type is taken into consideration, e.g. the alarm signaling output will not react to a change of state of the arming zone.

Programming the list of zones makes the control panel to skip the programmed selection of zones when defining which zones are to activate the output.

For the outputs reacting to keypad events, the list of partitions is taken into consideration, while the list of zones is irrelevant (e.g. the 3 wrong codes alarm signaling).

The programming procedure is identical as in the functions FS8 – FS11.

FS33 - programming OUT2 output

The function defines the basic parameters associated with the OUT2 output. The programming procedure is same as for the **FS31**.

FS34 - programming list of zones OUT2 (BIT)

The function programs the list of zones associated with the OUT2 output. The programming procedure is same as for the **FS32**.

FS35 - programming OUT3 output

The function defines the basic parameters associated with the OUT3 output. The programming procedure is same as for the **FS31**.

FS36 - programming list of zones OUT3 (BIT)

The function programs the list of zones associated with the OUT3 output. The programming procedure is same as for the **FS32**.

FS37 - programming OUT4 output

The function defines the basic parameters associated with the OUT4 output. The programming procedure is same as for the **FS31**.

FS38 - programming list of zones OUT4 (BIT)

The function programs the list of zones associated with the OUT4 output. The programming procedure is same as for the **FS32**.

FS39 - programming OUT5 output

The function defines the basic parameters associated with the OUT5 output. The programming procedure is same as for the **FS31**.

FS40 - programming list of zones OUT5 (BIT)

The function programs the list of zones associated with the OUT5 output. The programming procedure is same as for the **FS32**.

FS41 - programming OUT6 output

The function defines the basic parameters associated with the OUT6 output. The programming procedure is same as for the **FS31**.

FS42 - programming list of zones OUT6 (BIT)

The function programs the list of zones associated with the OUT6 output. The programming procedure is same as for the **FS32**.

Monitoring - programming parameters of transmission to monitoring stations

FS43 - programming station 1 telephone number (HEX)**FS44 - programming station 2 telephone number (HEX)**

In functions FS43 – FS44 are programmed numbers of up to 16 characters (digits and control codes) in the same way as the computer telephone number (FS4).

FS45 - programming station 1 format (HEX)**FS46 - programming station 2 format (HEX)**

The functions FS45 – FS46 define the standard of event transmission to the monitoring stations. The programming consists in entering a double-character format number according to the list below and confirming it with the key [#].

TRANSMISSION FORMATS:

- 00 - Silent Knight, Ademco slow (1400Hz/10Bps)
- 01 - Sescoa, Franklin, DCI, Vertex (2300Hz/20Bps)
- 02 - Silent Knight fast (1400Hz/20Bps)
- 03 - Radionics 1400Hz
- 04 - Radionics 2300Hz
- 05 - Radionics with parity 1400Hz
- 06 - Radionics with parity 2300Hz
- 07 - Ademco Express
- 08 - Silent Knight, Ademco slow, extended
- 09 - Sescoa, Franklin, DCI, Vertex, extended
- 0A - Silent Knight fast, extended
- 0B - Radionics 1400Hz, extended

- 0C - Radionics 2300Hz, extended
- 0D - Telim with entry tone – without signalling test of connection
- 0E - Contact ID selected codes
- 0F - Contact ID all codes
- 8D - Telim without entry tone – with full signalling test of connection

FS47 - programming reporting options (BIT)

These options define how the communication with monitoring stations is established and how the events codes are transmitted.

MONITORING OPTIONS:

Option No.		Option	Signaling	
LED	LCD		LED	LCD
1	1	report to station 1 only, without event sorting*	ON	Y
		report to station 1 or station 2, without event sorting**	OFF	
2	2	report to station 2 only, without event sorting*	ON	Y
		report to station 1 or station 2, without event sorting**	OFF	
3	3	event sorting by identifiers (event groups) during transmission to station 1	ON	Y
		sorting disabled for station 1	OFF	
4	4	event sorting by identifiers (event groups) during transmission to station 2	ON	Y
		sorting disabled for station 2	OFF	
5	5	extend reported partition events code with user number - access code number (hexadecimal code; MASTER user - "F"; other users - "1"..."C"; quick arming - "D"; TIMER - "E")	ON	Y
		automatic extension with user number disabled	OFF	
6	6	extend reported zone events code with zone number (hexadecimal code; for zone 16 no code extension)	ON	Y
		automatic extension with zone number disabled	OFF	
7	7	the panel skips sending the events code if STATION 1 fails to acknowledge receiving the information after 16 attempts	ON	Y
		the panel skips sending no codes to STATION 1	OFF	
8	8	the panel skips sending the events code if STATION 2 fails to acknowledge receiving the information after 16 attempts	ON	Y
		the panel skips sending no codes to STATION 2	OFF	

* If transmission to the station 1 and 2 is selected at the same time, it will be performed with event sorting. The event sorting is programmed with corresponding service functions, separately for each group of events.

** If no transmission is selected to any station, one of the stations is notified - the one to which the connection was established first.

Notes:

- The options 3 and 4 are used when separate identifiers are assigned to particular event groups, and the station to which messages are sent identifies the system by the first identifier received. In such a case, the control panel can initiate a new connection for each event group. Events from the control panel buffer are then sorted so that all events of the same group (i.e. having the same identifier) can be sent during one connection.

- *The options 5 and 6 are only meaningful when double-character codes are reported (with 4/2 or 3/2 format). Single-character codes are then programmed (the second character being 0, which is not sent), and the control panel, with the extension option on, will add, respectively, the zone number or the user number as the second character. Upon entering a double-character event code where both characters are different from 0, it will be sent without the zone number / user number extension. Extensions of the event codes by the zone number or the user number permit entering identical codes for events of one type for all zones or partitions, with their subsequent differentiation based on the added character.*

Monitoring - programming identifiers

The functions FS48 to FS59 are used to program identifiers to be sent to the monitoring stations. Depending on the needs, the control panel can send to the station quite detailed data on the events occurring in the system, or just the basic ones. With two-character codes, it is possible to send information on 225 events.

In order to circumvent restrictions caused by the transmission formats, some solutions have been applied in the CA10 control panel, which consist in grouping the events (zone events, partition 1 events, etc.) and assigning a separate identifier to each group.

In case of a small amount of information being sent (less than 225 different events), **all the identifiers for the particular station are to be programmed identically**, and the event sorting mode is to be disabled in monitoring options.

In the LED keypads, the programming is carried out in the way typical of hexadecimal (HEX) functions. When programming the first two characters, the LED 12 is blinking, with the next two - the LED 11. In the LCD keypads, the programming is performed by the method typical of multi-digit hexadecimal (HEX) functions.

For the data formats 3/1 and 3/2, the last character should be 0 - **the control panel will send characters from 1 to F, 0 not being sent.**

Note: *If the monitoring station requires an identifier containing the digit **zero**, enter the character "A" instead of zero (e.g. the identifier "1203" should be entered as "12A3").*

EXAMPLE: (for LED keypad)

- programming the zone event identifier for the station 1 = A243
- [4][8] [#] - call the function
- [*0][2] [#] - enter the first two characters of identifier (LED 12 blinking)
- [4][3] [#] - enter the next two characters of identifier (LED 11 blinking) and confirm them - exit the function

FS48 - programming zone events identifier for station 1 (HEX)

FS49 - programming partition 1 events identifier for station 1 (HEX)

FS50 - programming partition 2 events identifier for station 1 (HEX)

FS51 - programming partition 3 events identifier for station 1 (HEX)

FS52 - programming partition 4 events identifier for station 1 (HEX)

FS53 - programming system events identifier for station 1 (HEX)

FS54 - programming zone events identifier for station 2 (HEX)

FS55 - programming partition 1 events identifier for station 2 (HEX)

FS56 - programming partition 2 events identifier for station 2 (HEX)

FS57 - programming partition 3 events identifier for station 2 (HEX)

FS58 - programming partition 4 events identifier for station 2 (HEX)

FS59 - programming system events identifier for station 2 (HEX)

Monitoring - programming zone report codes

The zone report codes are programmed in the functions FS60 to FS66, and also FS134 and FS135. Each of them is used for programming a code of one event for each of the 16 zones of the panel.

The zone events codes may be either single or double character. When entering a single-character code (for the data formats 4/1 and 3/1, or where the mode of code extension by zone number is used – see: FS47 "Monitoring options") one of the characters must be equal to 0. The 0 character is not sent.

Programming 00 will result in skipping the event when the events are being reported to the station.

The programming consists in entering two characters (from 0 to F) for each zone and confirming them.

When programming in the LED keypad, the LEDs show value of the character entered (from 1 to 4 - the first character, and from 5 to 8 - the second character of the code) and number of the zone for which the code is programmed (LEDs 9 to 12).

EXAMPLE:

programming the alarm codes for the zones 1 to 7 (codes from 41 to 47) and 9 to 16 (codes from 48 to 4F), the zone 8 not being an alarm one.

```
[6][0] [#] - call the function
[4][1] [#] - program the code for zone 1
[4][2] [#] - program the code for zone 2
[4][3] [#] - program the code for zone 3
[4][4] [#] - program the code for zone 4
[4][5] [#] - program the code for zone 5
[4][6] [#] - program the code for zone 6
[4][7] [#] - program the code for zone 7
[0][0] [#] - program the code for zone 8 (no event for zone 8)
[4][8] [#] - program the code for zone 9
[4][9] [#] - program the code for zone 10
[4][*0] [#] - program the code for zone 11 (code 4A)
[4][*1] [#] - program the code for zone 12 (code 4B)
[4][*2] [#] - program the code for zone 13 (code 4C)
[4][*3] [#] - program the code for zone 14 (code 4D)
[4][*4] [#] - program the code for zone 15 (code 4E)
[4][*5] [#] - program the code for zone 16 (code 4F), quit the function.
```

FS60 - programming zone alarm codes (HEX)

The codes programmed with this function are reported when the control panel detects violation of the zone which triggers an alarm. 16 zones of the panel are successively programmed.

FS61 - programming zone tamper alarm codes (HEX)

The codes programmed with this function are reported when the control panel detects violation of the anti-tampering contact in 2EOL/NC and 2EOL/NO zones, which triggers a tamper alarm.

FS62 - programming zone trouble codes (HEX)

The codes programmed with this function are reported when the control panel detects trouble of a detector associated with the zone (too long zone violation and/or too long zone no-violation time).

FS63 - programming zone violation codes (HEX)

The function is used for programming the zone violation codes. The zone violation code is transmitted to the monitoring station in case of:

- **violation of an armed delayed zone** (of ENTRY/EXIT, INTERIOR DELAY, DELAY type) when the control panel has started the entry delay countdown,
- **violation of an armed counting zone** – when the number of violations still does not trigger an alarm,
- **violation of a DAY/NIGHT zone when it is disarmed,**
- **violation of an armed zone when the zone already signals an alarm** - during the alarm no subsequent alarms are signaled, and the consecutive detector excitations are recorded in the event log as “zone violation”; when the alarm signaling is over, each next violation of the detector will trigger an alarm.

Note: A trouble to program the codes of alarms and violations for all the zones may result in the station being not notified of the alarm. If one of the control panel zones has no alarm code assigned to it, and it will trigger an alarm, the excitations of subsequent detectors which occur during the alarm will be saved in the memory as zone violations, not alarms. If the system comprises any zones triggering an alarm of which the monitoring station is not notified, it is necessary to enter the same violation codes for the monitored zones as for the alarms.

FS64 - programming zone RESTORE codes (HEX)

The codes programmed with this function are sent after the zone returns to its normal state (according to the setting of corresponding zone options).

FS65 - programming zone TAMPER RESTORE codes (HEX)

The codes programmed with this function are sent after the anti-tampering contact of detector associated with the zones 2EOL/NC and 2EOL/NO returns to its normal state.

FS66 - programming zone TROUBLE RESTORE codes (HEX)

The codes programmed with this function will be sent after the trouble ends (i.e. when the zone is restored to its normal state after too long a violation, or when a violation occurs after "too long time of no violation").

FS67 - programming zone events assignment to station 1 (BIT)**FS68 - programming zone events assignment to station 2 (BIT)**

The functions define, which zone events are to be sent to station 1, and which to station 2, when in FS47 the transmission is programmed to both stations.

Option No.		Option	Signaling	
LED	LCD		LED	LCD
1	1	send ZONE ALARM code	ON	<input checked="" type="checkbox"/>
		do not send ZONE ALARM code	OFF	<input type="checkbox"/>
2	2	send ZONE TAMPER ALARM code	ON	<input checked="" type="checkbox"/>
		do not send ZONE TAMPER ALARM code	OFF	<input type="checkbox"/>

3	3	send ZONE TROUBLE ALARM code	ON	Y
		do not send ZONE TROUBLE ALARM code	OFF	
4	4	send ZONE VIOLATION ALARM code	ON	Y
		do not send ZONE VIOLATION ALARM code	OFF	
5	5	send ZONE RESTORE code	ON	Y
		do not send ZONE RESTORE code	OFF	
6	6	send ZONE TAMPER RESTORE code	ON	Y
		do not send ZONE TAMPER RESTORE code	OFF	
7	7	send ZONE TROUBLE RESTORE code	ON	Y
		do not send ZONE TROUBLE RESTORE code	OFF	
8	8	send "ZONE BYPASSED" & "ZONE UNBYPASSED" codes	ON	Y
		do not send "ZONE BYPASSED" & "ZONE UNBYPASSED" codes	OFF	

Note: Defining the event assignment is necessary for the mode of reporting to both stations with event sorting. Unassigned events will not be sent, despite correct programming of their codes.

Monitoring - programming partition report codes

FS69 - programming partition 1 events codes (HEX)

FS70 - programming partition 2 events codes (HEX)

FS71 - programming partition 3 events codes (HEX)

FS72 - programming partition 4 events codes (HEX)

In each partition, the control panel distinguishes fifteen events, whose codes are programmed separately for each partition (functions FS69 to FS72). The rules of programming the partition event codes are the same as for the zone event codes. The partition event codes may be extended by the user number (see: FS47) in the same way as the zone event codes may be extended by the zone number.

The programming consists in assigning two characters (from 0 to F) to each partition event and confirming them.

During programming in the LED keypad LEDs 1-8 show the programmed code (1-4 the first character, 5-8 the second character of the code). The LEDs 9 to 12 show the number of event programmed, according to the list below:

Number	LEDs 9-12	Event	
1	○○○◎	Arming	*
2	○○◎○	Silent arming	*
3	○○◎◎	Arming with bypass	*
4	○◎○○	Clearing alarm	*
5	○◎◎◎	Disarming	*
6	○◎◎○	not used	
7	○◎◎◎	Time setting	*
8	◎○○○	Zone bypass	*
9	◎○○◎	Keypad FIRE alarm	
10	◎○○○	Keypad PANIC alarm	

11	⊗○○⊗	Keypad auxiliary alarm
12	⊗⊗○○	Keypad tamper alarm
13	⊗⊗○⊗	3 wrong codes alarm
14	⊗⊗⊗○	DURESS alarm
15	⊗⊗⊗⊗	Internal partition arming
16	○○○○	Internal partition disarming

Notes:

- The events codes marked * can be extended by the panel with the user number (see: MONITORING OPTIONS).
- The "arming with bypass" code is sent when some of the partition zones were bypassed at the moment of arming.
- The code numbers 15 and 16 are sent when the partition was armed by the superior partition user (the corresponding events code, with the number of that user, is sent as part of handling the superior partition events).

FS73 - programming partition 1 events assignment to station 1 (BIT)**FS74 - programming partition 2 events assignment to station 1 (BIT)****FS75 - programming partition 3 events assignment to station 1 (BIT)****FS76 - programming partition 4 events assignment to station 1 (BIT)**

The functions FS73 to FS76 define which events from a given partition will be reported to the first monitoring station when the mode of reporting to both stations is activated.

In the LED keypads, the programming is carried out in two stages. In the first stage (LED 12 blinking) the events 1-8 are programmed, in the second stage (LED 11 blinking) - events 9-16.

FS77 - programming partition 1 events assignment to station 2 (BIT)**FS78 - programming partition 2 events assignment to station 2 (BIT)****FS79 - programming partition 3 events assignment to station 2 (BIT)****FS80 - programming partition 4 events assignment to station 2 (BIT)**

The functions FS77 to FS80 define which partition events will be reported to the second monitoring station when the mode of reporting to both stations is activated.

Monitoring - programming system report codes

Apart from the events from zones and partitions, the CA-10 panel can transmit information on system events (mainly related to the detected troubles). The rules of programming system event codes are identical to those for the zone event codes.

FS81 - programming system events codes - set I (HEX)

The function enables the first sixteen out of 26 system events codes to be programmed. The programming procedure is same as in FS69 – FS72.

The list of events and LED signaling in LED type keypads:

Number	LEDs 9-12	Event
1	○○○⊗	AC loss
2	○○⊗○	AC restore

3	○○◎◎	Low battery
4	◎◎○○	Battery restore
5	◎◎◎◎	Output OUT1 trouble
6	◎◎◎○	Output OUT1 restore
7	◎◎◎◎	Output OUT2 trouble
8	◎○○○	Output OUT2 restore
9	◎○○◎	Output OUT3 trouble
10	◎◎◎○	Output OUT3 restore
11	◎◎◎◎	Printer trouble
12	◎◎○○	Printer restore
13	◎◎◎◎	Enter service mode
14	◎◎◎○	Exit service mode
15	◎◎◎◎	Start DOWNLOADING
16	○○○○	End DOWNLOADING

FS82 – programming system events codes - set II (HEX)

The function enables the system events codes set II to be programmed. The programming procedure is same as in FS69 – FS72.

The list of events and LED signaling in LED type keypads:

Number	LEDs 9-12	Event
1	○○○◎	Output OUT4 trouble
2	○○◎○	Output OUT4 restore
3	○○◎◎	Reporting trouble
4	◎◎○○	Event log overflow
5	◎◎◎◎	Loss of time
6	◎◎◎○	RAM memory error
7	◎◎◎◎	System restore
8	◎○○○	Reporting test
9	◎○○◎	Keypad power supply trouble
10	◎◎◎○	Keypad power supply restore

Notes:

- *The code 3 is recorded in the event log when the control panel is unable to establish communication with the station. In that case, the control panel will retry after 120 seconds to establish connection. When it gets through, the control panel will transmit all events from the memory. The "transmission problems" code item makes it possible to asses when the oldest event occurred. The events are sent by the panel in the order of their occurrence (the oldest event is sent first), unless the event sorting mode is active. In such a case, the zone events are sent first, then the partition events, and the system events are sent last.*
- *The code 4 is recorded in the event log when lack of communication with the station lasted so long that all the memory intended for the events (255 in all) has been filled up and the oldest events have been erased.*

FS83 - programming system event assignment to station 1 (BIT)

When the mode of notifying both stations is active, the events programmed with the function FS82 are sent to both stations. For the other system events (programmed with the function

FS81), it is possible to determine, whether they will be sent to station 1, to station 2, or to both of them. The function FS83 selects events to be sent to station 1.

Programming in the LED keypad is a two-stage process.

In the first stage the LEDs 1 to 8 show the following events:

- 1 - AC loss
- 2 - AC restore
- 3 - Low battery
- 4 - Battery restore
- 5 - Output OUT1 trouble
- 6 - Output OUT1 restore
- 7 - Output OUT2 trouble
- 8 - Output OUT2 restore

In the second stage the LEDs 1 to 8 show the following events:

- 1 - Output OUT3 trouble
- 2 - Output OUT3 restore
- 3 - Printer trouble
- 4 - Printer restore
- 5 - Enter service mode
- 6 - Exit service mode
- 7 - Start DOWNLOADING
- 8 - End DOWNLOADING

FS84 - programming system event assignment to station 2 (BIT)

The function makes it possible to select system events sent to the station 2, when the mode of reporting to both stations is active. The programming procedure is identical as in FS83.

FS85 - programming test transmission time (DEC)

The control panel can send the test transmission every 24 hours. The function FS85 sets the hour and minute for sending the test code to the monitoring station. The programming consists in entering two two-digit numbers: hours (00 to 23) and minutes (00 to 59). After confirmation of the minutes, the panel quits the function. Entering 99:99 disables the test transmission function.

EXAMPLE (for LED keypad):

- programming the test code to be sent at 1:45
- [8][5] [#] - call the function
- [0][1] [#] - enter the hour for message sending
- [4][5] [#] - enter the minutes and exit the function

FS86 - programming the „AC loss” report delay (DEC)

The function defines the time from the mains supply loss after which the panel will send an „AC loss” message to the monitoring station. The delay time is programmed in minutes, within the range from 01 to 99 minutes. The mains supply loss is signaled instantly in keypads and on the AC loss indicator outputs.

Messaging – programming telephone number

FS87 - programming telephone number 1 (HEX)

FS88 - programming telephone number 2 (HEX)

FS89 - programming telephone number 3 (HEX)

FS90 - programming telephone number 4 (HEX)**FS91 - programming telephone number 5 (HEX)****FS92 - programming telephone number 6 (HEX)****FS93 - programming telephone number 7 (HEX)****FS94 - programming telephone number 8 (HEX)**

The functions FS87 to FS94 are used to program the telephone numbers to which the control panel sends alarm messages. Each telephone number can have up to sixteen digits and special characters. The numbers are to be programmed in the same way as in the function FS4.

FS95 - programming assignment of partitions and messages (BIT)

Reporting alarm messages depends on which partition is alarming. The function FS95 associates telephone numbers with partitions and defines which message is to be sent. The programming consists in indicating, for each telephone number, the partition number and the number of message to be sent.

In the LED keypads, the programming is carried out by means of the numeric keys and signaled by lighting or extinguishing of the respective LEDs. When entering the data, the following information is indicated on LEDs:

- LEDs 9-12 – following telephone number (from 1 to 8, binary)
- LEDs 1-4 – the assignment of partitions to a consecutive numbers:
 - 1 - telephone number for partition 1
 - 2 - telephone number for partition 2
 - 3 - telephone number for partition 3
 - 4 - telephone number for partition 4
- LEDs 5-8 - the assignment of message sent to a consecutive number:
 - 5 - message 1 for paging system
 - 6 - message 2 for paging system
 - 7 - message 3 for paging system
 - 8 - message 4 for paging system

Note: *If no message for the paging system is assigned to the number, the panel will send a **voice message** from the synthesizer.*

EXAMPLE:

programming of the following settings (assuming that LEDs 1 to 8 for all numbers are off)

- 1st telephone number - voice message from synthesizer, with alarm in partition 1,2, 3,
- 2nd telephone number - message No. 2 (pager), with alarm in partition 1,
- 3rd and 4th tel. number - voice message from synthesizer, after alarm in partition 3
- other numbers not used

- [9][5] [#] - call the function (LED 12 is blinking - 1st number)
- [1][2][3] - LEDs 1, 2 & 3 go on (number 1 assigned to partitions 1, 2 & 3) other LEDs are off
- [#] - confirm assignment for number 1 (LED 11 is blinking - 2nd number)
- [1] - LED 1 goes on (number 2 assigned to partition 1)
- [6] - LED 6 goes on (message 2 assigned to number 2)
- [#] - confirm assignment for number 2 (LEDs 11, 12 are blinking - 3rd number)
- [3] - LED 3 goes on (number 3 assigned to partition 3)
- [#] - confirm assignment for number 3 (LED 10 is blinking - 4th number)
- [3] - LED 3 goes on (number 4 assigned to partition 3)
- [#] - confirm assignment for number 4 (LEDs 10, 12 are blinking - 5th number)
- [*] - exit the function. As for the other numbers all the LEDs 1 to 8 are off, the control panel will not dial those numbers.

In the LCD keypads, the programming is carried out by means of the arrow keys and the numeric keys. The keys ▲ and ▼ scroll the list of telephone numbers, the numeric keys 1-4 are used for selecting the partition which will be assigned to the given telephone number, the keys ◀ and ▶ assign a corresponding message to the given telephone number (the message can also be assigned by means of the numeric keys 5-9 and 0).

Messaging – programming of PAGER messages

FS96 - programming message 1 (POLPAGER format)

FS97 - programming message 2 (POLPAGER)

FS98 - programming message 3 (POLPAGER)

FS99 - programming message 4 (POLPAGER)

The message is programmed in the same way as with direct telephone messaging to the POLPAGER receiver. The control panel saves in its memory the consecutively depressed keys, and when transmitting the message, it generates corresponding two-tone signals, according to the telephony standard.

After calling the function, the panel enters the numerical mode (identically, as the POLPAGER exchange). Each depression of a key means that a corresponding digit has been added to the message.

In the LED keypad changeover to the text mode follows a double depression of the [*] key. When in the text mode, each key (from 1 to 9) has three letters assigned to it (see figure 2). Pressing a key means selection of the middle letter. Pressing in turn the key and [*] means selection of the left-hand letter. The letter on the right side of a key can be accessed by pressing that key and [#]. To access the space, press the [0] key. The dash is accessible by pressing the [0][*] keys. Changeover from the text to numerical mode is effected after pressing the [0][#] keys.

The message programming is ended after pressing the [#] key when the control panel is in the numerical mode, while the next depression of [#] results in exiting the function.

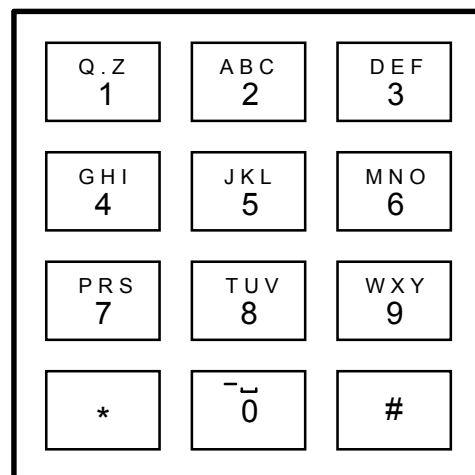

Figure 2.

The control panel saves in memory 80 keystrokes. At an attempt to enter a longer message, the panel quits the function (adding # or 0## if it was in the text mode).

EXAMPLE:

- programming the ALARM message
- [9][6] [#] - call the function (LED 9 is blinking - programming the 1st message)
 - [*] [*] - activate the text mode
 - [2] [*] - A
 - [5] [#] - L
 - [2] [*] - A
 - [7] - R
 - [6] [*] - M
 - [0] [#] - change over to the numerical mode
 - [#] - end the message
 - [#] - exit the function.

In the LCD keypads, one-time pressing the key [*] results in changeover to the text mode (programming details see: „Editing texts in LCD keypads”).

Messaging – programming of messaging parameters

FS100 - programming number of queues and retries in a queue (DEC)

The function is used to program two parameters of the telephone communicator which define how the messaging works. These parameters are:

- number of message queues (from 1 to 7) - setting a greater number gives a better reliability of reporting,
- number of dialing retries within one queue (from 1 to 9, and if 0 is entered - until a successful transmission). This parameter has been introduced so as to avoid blocking of the telephone line continuously dialing the number which cannot be reached (when nobody answers the call or the panel receives the busy signal all the time, etc.).

In the LED keypads the programming consists in entering two digits. **The first of them refers to the number of retries, the second - to the number of message queues.**

In the LCD keypads, starting the function will display the number of retries in a message queue, which is defined by entering the selected digit. To proceed to programming the second parameter, press the key ▲ or ▼.

FS101 - programming number of rings before answer (DEC)

The function sets the number of rings after which the CA-10 control panel will answer the call in order to report the alarm system status or to establish communication with the computer. The programming consists in entering a number from 00 to 07.

Depending on how the answering option is set (function FS 5, 8 bit in the second set of options), the control panel will answer the call immediately after detecting the programmed number of rings, or on the first ring detected after an interval lasting less than 5 minutes from detecting the programmed number of rings ("double call").

Notes:

- *Having answered a call in the "single call" mode, the panel will not answer any more calls for about 5 minutes so as to enable access to other equipment connected after the panel (e.g. automatic answering system, fax/modem).*
- *When the option to establish communication with the control panel by the computer is disabled, and the call answering is on, the control panel will only answer the calls when all defined partitions are armed.*

Functions programming TIMERS

The CA-10 control panel is equipped with four TIMERS, which compare on the current basis the panel clock with the times set on the TIMERS. If the times are consistent, the timers perform the functions assigned to them.

FS102 - programming TIMER 1 (DEC)

The function defines the hour and minute of setting the TIMER 1 on and off. The timer may perform the function of arming only or disarming only – if this is the case, enter 99:99 as the on/off hour. If the timer is to be used for disarming only, it is also necessary to select the „partition timer priority...” option (FS131, the first set of options).

In the LED keypads, the programming consists in entering four two-digit numbers, the first two of them meaning the on-time (hour, minute), and the other two - the off-time (hour, minute).

EXAMPLE:

- programming the TIMER 1 - ON 16:30, OFF 06:30
- [1][0][2] [#] - call the function
 - [1][6] [#] - programming the on hours (the LED 12 is blinking)
 - [3][0] [#] - programming the on minutes (the LED 11 is blinking)
 - [0][6] [#] - programming the off hours (the LEDs 11 and 12 are blinking)
 - [3][0] [#] - programming the off minutes (the LED 10 is blinking) and exit the function.

In the LCD keypads, starting the function will display the timer on-time, which is defined by entering the selected time value. To proceed to programming the off-time, press the key ▲ or ▼.

FS103 - programming TIMER 2 (DEC)

FS104 - programming TIMER 3 (DEC)

FS105 - programming TIMER 4 (DEC)

FS106 - programming TIMER functions (DEC)

The timers can serve one of the twelve functions. They can control outputs (the output indicated in this function must be of the TIMER type), or partitions.

The programming consists in entering four characters from 0 to B (twice two characters), the first character defining the function of TIMER 1, the second - TIMER 2, the third - TIMER 3, and the fourth - TIMER 4.

TIMER functions:

- 0 - TIMER not used
- 1 - controls output OUT1
- 2 - controls output OUT2
- 3 - controls output OUT3
- 4 - controls output OUT4
- 5 - controls output OUT5
- 6 - controls output OUT6
- 7 - partition control timer (guard control)
- 8 - controls partition 1
- 9 - controls partition 2
- A - controls partition 3 (in the LED keypads entered by [*0])
- B - controls partition 4 (in the LED keypads entered by [*1])

When the timer controls a partition or a output, both times are relevant: timer "on" and "off". When the guard control function is performed, only the first time programmed in the functions is used. The hour and minute of „switching on” as programmed for that timer define the maximum time that may elapse since the last time the guard code was entered - if it is exceeded, the “no control code” event will be recorded in the memory, the information will be sent to the monitoring station, and the “no partition control code” type output will be activated.

In the LED keypads, the programming consists in assigning particular functions to four timers in turn, by entering the functions from numeric keypad.

EXAMPLE:

programming the function: TIMER1 - controls partition 1, TIMER 2 - controls OUT4 output, TIMER 3 – controls OUT5 output, TIMER 4 - controls partition 4

[1][0][6] [#] - call the function

[8][4] [#] - program the functions of timers 1 and 2 (the LED 12 is blinking)

[5][*]1 [#] - program the functions of timers 3 and 4 (the LED 11 is blinking) and leaving the function

In the LCD keypads, the number of timer function is entered by means of the numeric keypad or the arrow keys ◀ ▶. Scrolling through the list of timers, the functions of which are to be defined, is performed by means of the keys ▲ and ▼.

Special Functions

FS107 – factory default settings restoration

Calling this function will restore all the factory default settings of the control panel parameters (see: Settings List) and will automatically program current address of the keypads (and expander). The function does not change the user access codes.

FS108 - clearing event log

Calling this function will erase the memory of events.

FS109 - factory default identifiers restoration

Calling this function will restore the factory default identifiers of control panel and computer, which are required for the panel to establish communication with the computer. These settings are used for testing the control panel.

FS110 - factory default codes restoration

Calling this function will erase all the user access codes and restore the default codes:

- service code = 12345
- MASTER code, partition 1 = 1234
- MASTER code, partition 2 = 2345
- MASTER code, partition 3 = 3456
- MASTER code, partition 4 = 4567.

FS111 - programming keypad addresses (BIT)

The keypads of CA-10 panel have an individual address (in the LED type keypads it is set with jumpers, in the LCD keypads - by software means). The panel imports this address together with other keypad data (zone state, depressed keys, anti-tampering) and compares with the address programmed in the nonvolatile memory for each keypad. If a difference is detected, a tamper alarm is triggered.

A keypad with incorrect address is not recognized by the control panel. The addresses are not controlled, when the panel is in the service mode.

The keypad addresses are set by the panel automatically after the reading with the service function **FS124** or when restoring the default settings **FS107**. The function FS111 enables the addresses to be checked and programmed manually from keypads.

Note: *In a system equipped with LCD keypads, manual modification of the keypad addresses with the function FS111 is not allowed.*

In the LED keypads the programming consists in lighting up the **LEDs** which correspond to the jumper settings. It is performed in two steps. In the first step, the LEDs 1 to 4 show the address of partition keypad 1 (CLK1), and the LEDs 5 to 8 - the address of keypad 2 (CLK2).

In the second step, the addresses of keypad 3 (CLK3, LEDs 1 to 4) and keypad 4 (CLK4, LEDs 5 to 8) are set. The settings are confirmed with the [#] key.

The [*] key enables you to exit the function.

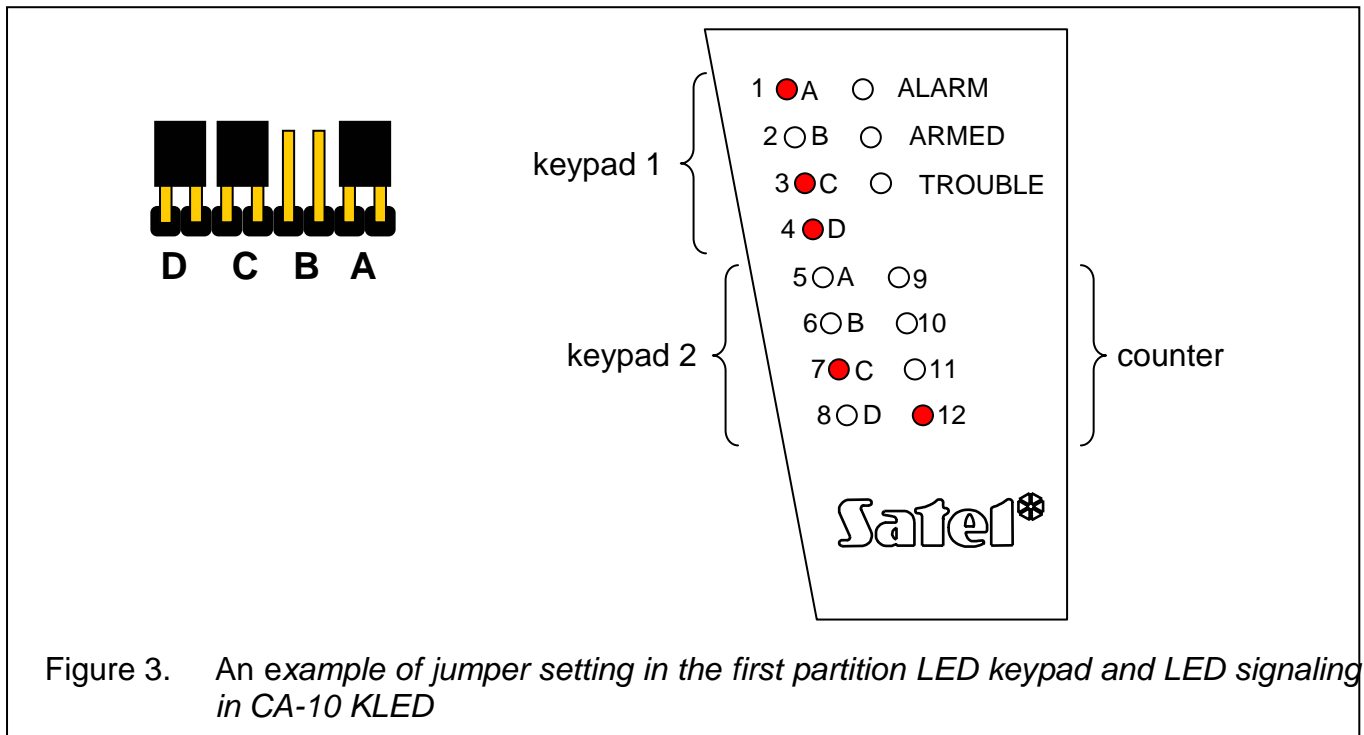

Notes:

- The control panel does not support LED keypads in which either all jumpers or no jumpers are set, as well as LCD keypads in which the address 0000 or 1111 has been programmed.
- When programming the keypad addresses be particularly careful, as **having programmed wrong addresses** will trigger a tamper alarm on quitting the service mode and loss of the ability to control the panel from the keypad. Then it is necessary to enter the service mode by hardware means and read the new addresses (see: Installer Manual).
- The new addresses (as most of the programmed parameters of the panel) will become valid after exiting the service mode or - when the panel is being programmed from the computer - after the data are sent.

FS112 - start of programming through RS-232

The function starts the panel programming through the RS-232 interface.

Prior to using the function:

- hook up the control panel to the computer (see: Installer Manual);
- start the DLOAD10 program on the computer and select the number of communication port (COM);
- call the service mode in the panel and activate the function FS112.

Calling the function FS112 will be signaled by the panel with lighting the TROUBLE LED. If the panel receives no computer readiness signal within 10 seconds (due to an incorrect computer connecting cable or port number) the function will be automatically exited.

The waiting for the computer command during an active connection is signaled by one short beep every 10 seconds. When the connection is broken, the control panel quits the function and enters the service mode.

Having entered the FS112 function, the keypad accepts no commands from keypad - the control panel receives commands from computer. The function is exited after sending a suitable command by the computer (while exiting the service mode). It is possible to quit the function by pressing and holding down the [*] key for about 3 seconds.

It is possible to program the control panel from a PC computer without calling of the function FS112 in the keypad (see: Installer Manual).

Functions related to memory of events

FS113 - event log printout (all events)

The control panel event log can be printed if a printer with RS-232 port is connected to the control panel. The printout is started by calling the function. No DTR signal from the printer will terminate the function and an error will be signaled (two short beeps). Holding down the [*] key will stop the printout.

Note: Activation of the "printing on" option is not necessary - it regards a situation, when the printer is connected permanently.

FS114 - alarm log printout

It operates in the same way as FS113, but alarms only are printed.

FS115 - trouble log printout

It operates in the same way as FS113, but troubles only are printed.

FS116 - partition event printout (arming/disarming)

It operates in the same way as FS113, but only arming and disarming events are printed.

Messaging – programming of messaging parameters

FS117 - permissible telephone line loss delay (DEC)

The function defines how many minutes may elapse from the low voltage condition on the telephone line to the moment the panel reports a trouble. The programming consists in entering a two-digit number from 00 to 99 minutes. If 00 is programmed, the panel will never report a trouble.

EXAMPLE (for LED keypad):

```

                programming a twenty-minute delay
[1][1][7] [#] - call the function
[2][0] [#] - program the delay

```

FS118 - parameters of pager station signals (HEX)

The function defines parameters of the answer signals generated by automatic pager station. As different answer signals are used in each system, it is necessary to specify the signal parameters of the system to which the panel transmits its messages. If parameters of such signals change, it will be sufficient to specify new data.

In the LED keypads the programming consists in entering six two-character codes which are suitable for the given paging system.

Messaging – programming of HEX messages

FS119 - programming message 1 (HEX)

FS120 - programming message 2 (HEX)

FS121 - programming message 3 (HEX)

FS122 - programming message 4 (HEX)

The functions FS119 – FS120 permits programming an alphanumeric message for any paging system. The programming consists in entering up to 84 message characters (in the LED keypads in two-character pairs), in a convention required by the given system.

Some systems require additional characters:

- A - #
- B - *
- C - end of message
- E - pause (required in some systems to separate the pager number from the message)
- D and F - same as C.

Note: *The functions FS119 - FS122 are an alternative to the functions FS96 - FS99. Each message can be programmed in two ways (in the HEX mode or in the POLPAGER receiver convention).*

Functions programming basic options

FS123- counters count-up times

The function makes it possible to program time intervals related to the counters 1, 2 and 3 of counting zones (see: FS7). The alarm will only be generated when the number of violations preset in FS7 takes place within the time interval defined by the function FS123. The count-up times may be programmed within the interval from 1 to 255 seconds (by default set at 30 seconds). If the number of violations programmed in the function FS7 does not take place within the time interval defined in the function, after expiry of the time the counting zone counters will be reset.

Programming of the counters count-up times consists in entering a number from the range of 1 to 255 for each counter.

In the LED type keypads, after starting the function, you should enter one, two or three digits for the first counter. Upon confirmation with the key [#], the control panel proceeds to programming the count-up time of the next counter. In the course of programming, the LEDs 9-12 indicate in binary form which counter the parameter refers to. On the LEDs 1-8, the control panel displays the previously programmed setting of the parameter in the binary form. The programming can be terminated by pressing the key [*].

EXAMPLE

- changing the counter count-up time: the first to 60 seconds, the second to 150 seconds, the third to 255 seconds
- [1][2][3] [#] - call the function
 - [6][0] [#] - enter the count-up time for counter 1 (LED 12 is blinking during programming)
 - [#] - confirm the counter 1 count-up time and proceed to programming counter 2
 - [1][5][0] [#] - enter the count-up time for counter 2 (LED 11 is blinking during programming)
 - [#] - confirm the counter 2 count-up time and proceed to programming counter 3
 - [2][5][5] [#] - enter the count-up time for counter 3 (LEDs 11 and 12 are blinking during programming)
 - [#] - confirm the counter 3 count-up time and quit the function

In the LCD keypads, the keys ▲ and ▼ scroll the list of counters for which a defined time value is entered from the numeric keypad.

Special Functions

FS124- keypad address auto-detect

The function enables the keypad addresses to be automatically detected without changing the other parameters.

In the LCD keypad, the function FS124 performs additional configuration operations, hence, after each modification of the configuration (adding or deleting keypad and/or expander) it is necessary to call the FS124 in each LCD keypad connected to the control panel.

FS125- testing outputs

The function makes it possible to check that all the wiring of control outputs for signaling devices or other equipment is properly connected. For functional check of an output, call the function and press the key with number of the output (1-6). Enabling the output is acknowledged with two short beeps, and, in the LED keypads, also by lighting a LED with the output number, and in the LCD keypads - by displaying the output number. The output will be disabled by pressing again the key with the output number (one short beep and extinguishing of the LED in LED type keypads or disappearing from the display of the output number in the LCD keypads).

Calling the function will disable all the active outputs (if they have been active), while quitting the function will reset the same. If the outputs OUT5 and OUT6 are functioning in the „radio messaging control” mode (FS5 option 7 of the second set), the function will not make them available for testing.

Monitoring - programming system reporting codes

FS126- programming guard control codes (HEX)

The function is used for programming the system events codes - set III. This codes are sent to monitoring station with system events identifier. The rules of programming the partition codes of guard are identical with those for zone event codes. The codes may be extended by the user number (see: FS47) based on the same principles, as the zone event codes may be extended by the zone number.

The list of events and LED signaling in LED type keypads:

Number	LEDs 9-12	Event
1	○○○◎	Code of guard in partition 1
2	○○◎○	Code of guard in partition 2
3	○○◎◎	Code of guard in partition 3
4	○◎○○	Code of guard in partition 4)
5	○◎○○	Code of lack of guard in partition 1
6	○◎◎○	Code of lack of guard in partition 2
7	○◎◎◎	Code of lack of guard in partition 3
8	◎○○○	Code of lack of guard in partition 4

The programming procedure is identical as for the function FS69 – FS72.

Functions programming partition assignment

FS127- zones auto-bypassed on no exit in partition 1 (BIT)

FS128- zones auto-bypassed on no exit in partition 2 (BIT)

FS129- zones auto-bypassed on no exit in partition 3 (BIT)

FS130- zones auto-bypassed on no exit in partition 4 (BIT)

The functions FS127 and FS130 (**EXIT-BYPASS**) make it possible to program for each partition the zones which will be automatically bypassed if, after arming, there is no violation of the ENTRY/EXIT type zone during the exit delay (after arming the system, the user **has not left the facility** and has not violated any detector in the ENTRY/EXIT type zone).

The programming procedure is identical as for the function FS8 – FS11.

Special function

FS131 - programming additional options (BIT)

FIRST SET OF OPTIONS (for LED keypad, the LED No. 12 is blinking)

Option No.		Option	Signaling	
LED	LCD		LED	LCD
1	1	service mode disabled	ON	<input checked="" type="checkbox"/>
		service mode enabled	OFF	<input type="checkbox"/>
2	2	DTMF (MST-1) module supported	ON	<input checked="" type="checkbox"/>
		DTMF (MST-1) module not supported	OFF	<input type="checkbox"/>
3	3	pulse dialing ratio 1:1,5	ON	<input checked="" type="checkbox"/>
		pulse dialing ratio 1:2	OFF	<input type="checkbox"/>
4	4	global codes	ON	<input checked="" type="checkbox"/>
		individual codes for each partition	OFF	<input type="checkbox"/>
5	5	timer 1 priority enabled	ON	<input checked="" type="checkbox"/>
		timer 1 priority disabled	OFF	<input type="checkbox"/>
6	6	timer 2 priority enabled	ON	<input checked="" type="checkbox"/>
		timer 2 priority disabled	OFF	<input type="checkbox"/>
7	7	timer 3 priority enabled	ON	<input checked="" type="checkbox"/>
		timer 3 priority disabled	OFF	<input type="checkbox"/>
8	8	timer 4 priority enabled	ON	<input checked="" type="checkbox"/>
		timer 4 priority disabled	OFF	<input type="checkbox"/>

Option 1 refers to disabling the hardware access to the service mode. If this option is selected, it is only possible to enter the service mode by using the service access code. The procedure of entering the service mode when the service code has been lost and the option of starting the service mode by hardware means (jumpers) is locked is described in section „Restoring default settings, restarting codes”.

Option 2 refers to the control panel working together with the MST-1 module, which enables the panel to be operated via a telephone generating the DTMF signals. For such an operation to be possible, the option 3 of the first FS5 set („call answer”) must be activated.

Option 3 refers to the control panel dialer and defines the pulse dialing ratio during pulse dialing of a telephone number. Selecting the option sets its value at 1:1.5. If the option is not selected, the ratio is 1:2.

Selecting the **option 4** makes the codes entered in one of the partitions be also accepted in other partitions. The event log records no particular user number - the number is always 1, and on the event log printout the annotation (**USER**) is shown instead of the user number.

The options 5-8 set the partition timer priority during disarming. With this option selected, the timer will always disarm the partition, provided the timer function is enabled. If the option is not selected, the timer will disarm the partition only if it has armed it itself.

SECOND SET OF OPTIONS (for LED keypad, the LED No. 11 is blinking)

Option No.		Option	Signaling	
LED	LCD		LED	LCD
1	9	do not allow arming during battery trouble	ON	Y
		allow arming during battery trouble	OFF	
2	A	automatic reset of zone bypassing at midnight (00:00)	ON	Y
		do not reset zone bypassing AUTORESET 1/3	OFF	
3	B	service mode available only in one partition (access to service mode in other partitions keypads disabled)	ON	Y
		service mode available in all partitions	OFF	
4	C	display service message after tamper alarm	ON	Y
		no service message after tamper alarm	OFF	
5	D	keypad trouble alarm on until cleared	ON	Y
		keypad alarm on during trouble only	OFF	
6	E	audible tamper alarm in armed mode only	ON	Y
		tamper alarm always audible	OFF	
7	F	limit number of alarms from one zone to 3	ON	Y
		alarm will not occur if keypad is alarming	OFF	
8	G	VISONIC radio reporting on	*	ON
		VISONIC radio reporting off	*	OFF

* Option refers only to control alarm panels with PCB marked „VC-10P”

When **Option 2** is selected the bypassed zones will be unbypassed and the counters of the zones bypassed after 1 or 3 alarms will be reset at 00:00 hour.

Option 4 activates the function of displaying service message after tamper alarm until service intervention (using of service code).

Selecting the **Option 5** results, in the event of trouble, in the keypad LED signaling trouble until the trouble memory review function (key [7]) is called and ended by pressing [#] key.

Option 6 refers to deactivating the audible tamper alarm, if the alarm source partition is disarmed – the alarm is only signaled in the keypad.

Option 7 refers to limiting the number of triggered alarms to 3 per one zone at time intervals shorter than 1 minute. If, when the partition is armed, the control panel receives 3 violation messages concerning one zone in time intervals shorter than 1 minute, it will generate an alarm after each violation, all subsequent violations of that zone being ignored, unless at least one minute elapses since the last violation.

If this option is inactive, violation of a zone when the partition is armed will generate an alarm, provided the keypad is not already signaling a previous alarm. If the keypad is already signaling an alarm, violation of the zone will not cause a new alarm.

FS132 - programming of clock correction (DEC)

As time measurement by the control panel internal clock may differ from the real value, provision has been made for making a daily time correction. The function makes it possible to correct the time measurement by ± 19 seconds within 24 hours. For programming the time correction, use the function FS132 to enter the value of daily time shift of internal clock:

In the LED keypads, the programming consists in entering two digits, depending on the expected correction value (see table below).

Correction value[s]	-19	-18	-17	...	-2	-1	0	1	2	...	17	18	19
Programming	99	98	97	...	82	81	00	01	02	...	17	18	19

EXAMPLE:

- program the time correction by -12 seconds
- [1][3][2] [#] - call the function
- [9][2] [#] - enter the correction value (minus 12 seconds)

In the LCD keypads, the correction is programmed by means of the arrow keys: the key ▲ enters a negative correction, the key ▼ - a positive one.

Monitoring - programming system report codes

FS133 - programming the time of test transmission to the monitoring station (DEC)

The alarm system makes it possible to set a maximum time interval between transmissions of events codes. If the preset time interval elapses after the last monitored event, the control panel will send the test transmission code. The function parameter (three two-digit numbers meaning days, hours and minutes) determines the time counted from the last transmission. If any event, the code of which will be sent, occurs in the system, the control panel will start counting the time again. This feature can be disabled by programming 00,00,00.

EXAMPLE (for LED keypad):

- programming of the test code send after two and a half hours since the last transmission (communication test).
- [1][3][3] [#] - calling the function,
- [0][0] - entering the number of days (the LED 12 is blinking),
- [#] - confirming the parameter,
- [0][2] - entering the number of hours (the LED 11 is blinking),
- [#] - confirming the parameter,
- [3][0] - entering the number of minutes (the LEDs 11 and 11 are blinking),
- [#] - confirming the parameter and leaving the function.

Monitoring – programming zone report codes

FS134 - programming codes to bypass the control panel zones (HEX)

The codes programmed with this function are sent after calling the user function 4 and bypassing the control panel zones. The codes are programmed in the same way as the other zone events codes (FS60 – FS66).

FS135 - programming codes to unbypass the control panel zones (HEX)

The codes programmed with this function are sent after calling the user function 4 and unbypassing the control panel zones. The codes are programmed in the same way as the other zone events codes (FS60 – FS66).

Monitoring

FS136 – programming of prefix for extension of identifiers in TELIM transmission format

(Transmission format used in Germany.)

FS137 - programming codes to be sent to the monitoring station in TELIM transmission format

(Transmission format used in Germany.)

Monitoring – programming of identifiers

FS-138 - programming of VISONIC radio system address (DEC)

The address may take a value from 0 to 7.

During the programming in the LED keypads two digits should be entered – first 0, second should correspond the address.

EXAMPLE (for the LED keypad):

programming of address „5”.

- [1][3][8] [#] - call the function,
- [0][5] [#] - enter the address and exit the function.

FS-139 - programming the test transmission period for VISONIC radio system (DEC)

The function sets time intervals between sequential autotests which are transmitted over radio. First the number of hours should be set and next the number of minutes. The maximal value of programmed time interval is 99 hours and 99 minutes.

EXAMPLE (for the LED keypad):

programming of time interval of 1 hour and 15 minutes.

- [1][3][9] [#] - call the function,
- [0][1] [#] - enter the number of hours,
- [1][5] [#] - enter the number of minutes and exit the function.

Note: The service functions FS138 and FS139 refer only to control panels having PC board marked with the „VC-10P” symbol.

LCD keypad service functions

LCD keypad service functions are available in the control panel service mode through the submenu “LCD keypad menu”. The structure of the submenu follows:

LCD keypad menu:

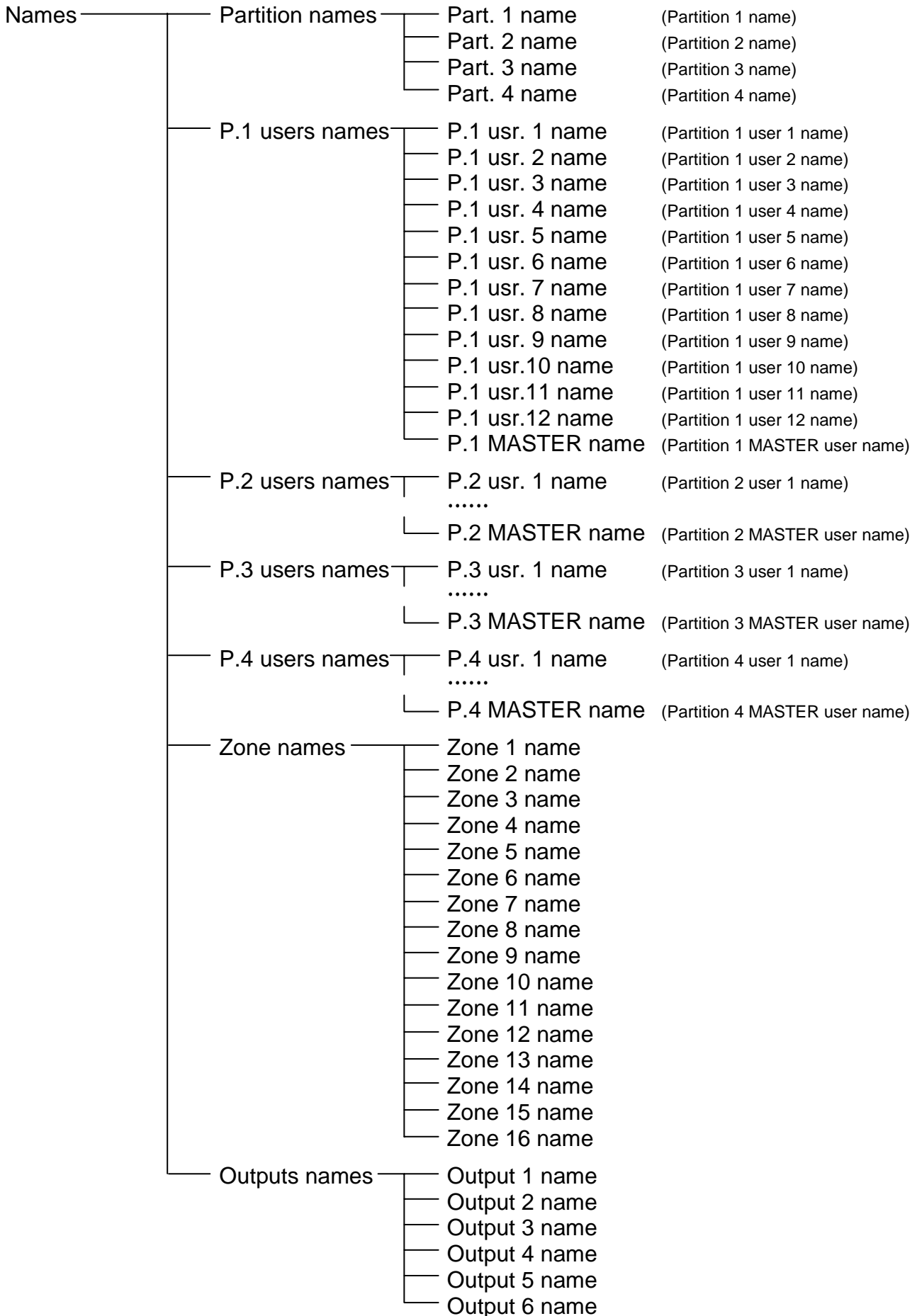

- Texts
 - System ok
 - System armed
 - Armed silent
 - Arming
 - Arming silent
 - Disarming
 - Zones bypassed
 - Alarm !
 - Fire alarm !
 - Alarm memory
 - Fire alarm mem. (Fire alarm memory)
 - Alarm off
 - System trouble
 - Entry time
 - Exit time
 - Time left:
 - Wait for data

- Symbols
 - LED std.symbols
 - LED off
 - LED on
 - Number of zones
 - LCD std.symbols
 - Zone ok
 - Zone bypassed
 - Zone violated
 - Zone tampered
 - Zone alarm mem. (Zone alarm memory)
 - Zone tamp.mem. (Zone tamper memory)
 - Part. 1 zones (Partition 1 zones)
 - Part. 2 zones (Partition 2 zones)
 - Part. 3 zones (Partition 3 zones)
 - Part. 4 zones (Partition 4 zones)

- Settings
 - Date Time format
 - State format
 - LCD backlight
 - Keys backlight
 - Keypad adress
 - GOTO function
 - Options

- Reset defaults
 - Default names
 - Default texts
 - Def. settings (Default settings)

Test

Names

The functions make it possible to change the descriptions of partitions, and the users of partitions, zones and outputs displayed in standard mode, to other ones.

Texts

Standard system messages (like "alarm", "armed" etc.) can be modified with this function according to user preferences and requirements of a specific installation.

Symbols

The functions make possible changing the standard display of characters signaling the zone status in operating modes according to LED or LCD standard (see: Settings→State format).

LED standard characters

The functions make it possible to change the symbols of extinguished/lit LED and define how many zones are to be indicated in the given partition keypad (similarly as the panel service functions FS12 - FS15).

LCD standard characters

The functions make it possible to change the characters indicating various zone statuses and define the zones whose status is to be displayed for the given partition (which is done in a similar way as with assignment of zones to partitions in the service functions FS8 - FS11).

***Note:** The choice of zones is used to select zones which are to be displayed as violated or alarming zones by corresponding panel functions.*

Settings

Time format

The function defines how the time is to be displayed. By default, the time is displayed according to the format: **dd mmm, hh:mm:ss**, i.e., in succession: day, month (the first three letters of a month name), hours, minutes and seconds. The following formats are available:

```
dd mmm, hh:mm:ss
dd.mm.yy, hh:mm
dd.mm.yyyy, hh:mm
no date and time
    hh:mm
    hh:mm:ss
dd mmm yy, hh:mm
```

Status format

The function selects the panel's operation mode:

- text messages - system status is communicated by means of textual messages,
- LED standard - status of maximum of 12 zones is displayed in a similar way as in the CA-10 KLED keypad according to the list programmed in the control panel service functions FS12 - FS15 or defined by the function „Number of zones” (Symbols→LED std.symbols→Number of zones),
- LCD standard - status of maximum 16 selected zones is displayed, indicating violations, alarms, tamper conditions, alarm log etc.

Display backlight

The function provides a choice of display illumination mode. The following settings are possible:

- no backlight (0)
- half power light (1/2)
- full power light (1)
- auto 0 – 1/2
- auto 0 – 1
- auto 1/2 - 1

Keypad backlight

The function provides a choice of keypad illumination mode. The following settings are possible:

- auto - is turned on after a key is pressed and then turned off after time set with use of option "Long backlight" (40 or 140 seconds)
- permanent
- no backlight

Keypad address

The function is used for defining the keypad hardware address.

GOTO function





To make the function GOTO accessible to the security system user, it is necessary to define which partitions are to be available from the given keypad. After confirming the partitions selection LCD keypad will perform FS-124 service function, which will set addresses of LCD keypads proper for the current configuration.

Notes:

- *If more than one LCD keypad is installed in the system, function GOTO settings should be separately programmed in each keypad.*
- *In the case of installation with an LCD keypad, expanders adapted to LCD keypads should be used (software version 2, manufactured since February 1998). Older expander versions will also operate with LCD keypads, but will not support multipartition systems.*

Options

The functions enables setting some additional parameters of LCD keypad:

Option	LCD display
displaying of exit delay on	
displaying of exit delay off	
audible signaling of exit delay on	
audible signaling of exit delay off	
texts priority on	
texts priority off	
key press sounds on	
key press sounds off	

backlight changing after key press on	T
backlight changing after key press off	
long backlight on (140s)	T
long backlight off (40s)	
permanent backlight of the keys and the LCD display on	T
permanent backlight of the keys and the LCD display off	
alternative type of menu on	T
alternative type of menu off	
functions assigned to arrow keys enabled	T
functions assigned to arrow keys disabled	

Texts priority parameter determines the way system status is displayed in the text mode. If it is off all relevant messages are displayed one after another in a closed cycle. If it is on only the highest priority message is displayed. The following priority levels are assigned by default (starting with the highest):

1. entry delay,
2. fire alarm,
3. burglary alarm,
4. armed (or silent armed)
5. fire alarm occurred,
6. burglary alarm occurred,
7. exit delay.

The option „Alternative type of menu” defines whether scrolling through the keypad menu by means of the keys ▲ and ▼ will also change the arrow position on the display, or not.

Reset Defaults

The function restores default parameters of keypad.

Test

This function enables a functional test of the keypad to be carried out and also restores the default settings of the keypad. To preserve your own parameters it is necessary to write them into computer before testing, and after testing they should be again programmed from the computer.

After the function is started, the test is first performed on the display, where all items are to be switched on. Pressing the key [*] results in switchover to the test of keypad backlight and correct lighting of LEDs. The next stroke of the key [*] starts the keypad test. Pressing all the keypad keys will test the keypad memory, which is signaled on the display by the message: „Wait for the end of the PCF test”. Then, the following items are tested: status of the keypad zones, tamper circuit, and data transmission. During the tests, you can make and break the inputs and the anti-tampering contact, to make sure their operation is correct. All the tests done, the following message will appear on the display: „Keypad ok, press *”. Pressing the key [*], or switching the power off and then again on will result in a restart of the keypad.

Note: After completion of the test, the function FS124 must be started.

Restoring default settings, restoring codes

Restoration of settings on entering the service mode by means of service code

If it is necessary to restore the default settings, you should enter the service mode and call the service functions FS107 (to restore all the default settings, except for the user access codes) and FS110 (to restore the partition master default codes, the other codes being erased). Also, the function FS108 can be performed (in order to erase the event log contents).

Restoration of settings on entering the service mode by hardware means

If the service mode is inaccessible (for example, when the control panel stopped responding to keypad commands because of a programming error, or the service code has been lost), to restore default settings follow the procedure below:

1. **Disconnect in turn the mains supply and the emergency supply.**
2. **Set a jumper on J19 RESET pins.**
3. **Connect in turn the emergency supply and the mains supply.**
4. **On hearing a beep in the keypad, remove the jumper from J19 pins (the 1st partition keypad will enter the service mode).**
5. **Perform function FS107 (restoring of default settings).**
6. **Perform function FS110 (restoring of default codes).**
7. **Exit the service mode or proceed with programming the control panel.**

This procedure can be disabled by software means (see: FS131 first option in the first set of option).

Note: *Similarly as in other SATEL control panels, shorting the pins and powering up alone will not restore any parameters. However, it will activate the service mode thus making it possible to check how the control panel has been programmed, and to analyze any programming errors.*

Restoration of settings when the option to enter the service mode by hardware means is locked and it is impossible to use the service code

If the option to enter the service mode by jumper setting is disabled (FS131 first option in the first set of option) and the panel does not recognize the service code, proceed as follows:

1. **Disconnect in turn the mains supply and the emergency supply.**
2. **Set a jumper on J19 RESET pins.**
3. **Connect in turn the emergency supply and the mains supply.**
4. **Wait about 60 seconds (± 5 sec.) and remove the jumper.**
5. **Enter from keypad the code: [1][2][3][4][5] (the code should be entered within 15 seconds) and confirm by pressing the [#] or [*] key.**

After these operations, the control panel should return to its default settings and remain in the service mode.

SATEL sp. z o.o.
ul. Schuberta 79
80-172 Gdańsk
POLAND
tel. + 48 58 320 94 00
info@satel.pl
www.satel.pl