



COMMUNICATION MODULE GSM-4

USER MANUAL

Program version 4.12



gsm4_en 10/10



WARNING

For safety reasons, the module should only be installed by qualified personnel.

In order to avoid any operational problems with the control panel, it is recommended that you become familiar with this manual before you start using the equipment.

Telephone terminals of the panel should be connected to **PSTN lines only**. Connecting to ISDN lines may cause damage to the equipment.

Never turn on power supply of the module and telephone without external antenna connected.

Making any construction changes or unauthorized repairs is prohibited. Particularly, do not remove the cover which protects electronic circuits against atmospheric discharge.

DECLARATION OF CONFORMITY		
Product: GSM-4 communications module	Manufacturer: SATEL spółka z o.o. ul. Schuberta 79 80-172 Gdańsk, POLAND tel. (+48 58) 320-94-00 fax. (+48 58) 320-94-01	
Product description: Communications module that provide GSM backup for PSTN line, allowing for alarm transmission in case of a failure or lack of telephone line.		
This product meet the essential requirements and is in conformity with following EU Directives: RTTE: 1999/5/EC EMC: 2004/108/EC LVD: 2006/95/EC		
This product is compliant with the following harmonized standards: EN 50130-4:1995/A1:1998/A2:2003, EN 61000-6-1:2007, EN55022:2006/A1:2007, EN 61000-6-3:2007, EN 60950-1:2006, EN 301 489-7:V1.3.1, EN 301 489-1:V1.8.1, EN 301 511 V9.0.2, 3GPP TS 51.010-1 V5.10.0		
Gdańsk, Poland	05.11.2009	Head of Test Laboratory: Michał Konarski 
Latest EC declaration of conformity and product approval certificates can be downloaded from our web site www.satel.pl		

CONTENTS

1. GSM-4 MODULE FEATURES	2
2. LIMITATIONS OF USE	3
3. DESCRIPTION OF THE MODULE	3
4. OPERATING THE TELEPHONE	7
5. INSTALLATION	7
6. OPERATION OF THE MODULE WITH ALARM CONTROL PANEL AND STATIONARY TELEPHONE	8
7. GSM-4 WITH MONITORING STATION	10
8. DESCRIPTION OF OUTPUTS AND INPUTS OF THE MODULE	10
8.1 OUTPUTS	11
8.2 INPUTS	11
9. METHODS OF CONTROLLING THE STATUS OF THE OUTPUTS AND BYPASSING THE INPUTS	12
9.1 REMOTE CONTROL	12
9.1.1 Tone control from telephone keypad	12
9.1.2 Remote bypassing by SMS messages	14
9.1.3 Controlling outputs by means of CLIP function	15
9.2 LOCAL CONTROL	15
9.2.1 Control by using module keys	15
9.2.2 Tone control from terminals R-1, T-1	16
9.3 CONTROLLING INPUTS AND OUTPUTS BY THE VIOLATION OF INPUTS	16
10. MESSAGING	17
10.1 SMS MESSAGES	17
10.2 VOICE MESSAGING	18
10.3 CLIP	19
10.3.1 CLIP with acknowledgement	19
10.3.2 CLIP without acknowledgement	19
11. TRANSMITTING SMS MESSAGES	20
11.1 DESCRIPTION OF THE PROCEDURE FOR CONVERTING PAGER MESSAGE INTO SMS MESSAGE	20
11.2 SENDING SMS MESSAGES FROM A STATIONARY TELEPHONE SET	21
11.3 THE RULES FOR CONVERTING THE NUMBERS	22
12. MONITORING	22
12.1 MONITORING GSM-4 MODULE STATUS	22
12.2 MONITORING CONTROL PANEL EVENTS	23
12.2.1 Connection through TIP, RING terminals	23
12.2.2 Connection through RS-232 port	23
13. DLOAD10 PROGRAM	23
13.1 "GSM-4" TAB	26
13.2 "TELEPHONE MESSAGING" TAB	27
13.3 "CONTROL/INPUTS/OUTPUTS" TAB	28
13.4 "GPRS/MONITORING" TAB	28
14. SERVICE MODE	30
15. DESCRIPTION OF FUNCTIONS FOR PROGRAMMING THE MODULE	36
15.1 CHOICE OF OPTION	36
15.2 ENTERING NUMERIC OR ALPHANUMERIC DATA	36
15.3 DESCRIPTION OF THE SERVICE FUNCTIONS	36
16. EXAMPLES OF PROGRAMMING THE NUMBERS AND PREFIXES	47
17. SPECIFICATIONS	49

1. GSM-4 MODULE FEATURES

- Simulation of analog telephone line by the use of cellular connection – which makes it possible to report an alarm situation at the site in case the analog line is out of order or missing.
- Operation with alarm control panels and with other equipment (e. g. DT-1 telephone set) using the telephone line for transmitting voice information about the alarm, or for sending text messages to paging system.
- Operation in conjunction with the STAM-1/STAM-2 monitoring station, which makes monitoring of the sites possible with the use of SMS short messages.
- Function of an external modem for the INTEGRA alarm control panels (support of DLOADX and GUARDX programs) and the CA-64 alarm control panels (support of DLOAD64 and GUARD64 programs)*.
- Answering incoming and making outgoing calls via cable telephone network and via mobile communication system (cellular network).
- Optional selection of the basic outgoing line: GSM/cable (subscriber line).
- Signaling of answering (receiving) a call initiated from the module T-1, R-1 terminals by changing the voltage polarization across those terminals (possibility of tariffication).
- Operation with PBX telephone exchange as additional subscriber's line.
- Pulse and tone dialing modes.
- Substitution of the direct access to cable telephone network and the access to cable telephone network via PBX.
- Four inputs, the violation of which (and restoring to normal status) can be monitored by SMS messages, voice messages or CLIP.
- Three outputs for controlling the electrical devices (e. g. by relays directly connected to the module).
- Output for signaling the telephone line failure and the cellular line failure.
- Test messaging (monitoring) in order to confirm the module operative condition.
- Possibility to control the outputs activity by violating the inputs (e.g. tripping alarm device after actuation of an alarm sensor) or by CLIP.
- Remote controlling of the status of module's outputs and bypassing of the module inputs by using SMS text message or dual tone phone push-buttons (DTMF Signals).
- Capability of recognizing the message directed to paging system and transmitting it in the form of SMS text message to any cellular telephone number. SMS messages are always sent, irrespective of availability of subscriber's telephone line.
- Possibility of restricting the access to cellular telephone by making connections to 32 precisely defined numbers, or reduction of available numbers by assigning initial digits to such numbers.
- Operation with three-range professional industrial cellular telephone, compatible with GSM 900/1800/1900 Mhz networks.
- Checking for cellular telephone availability and for antenna signal level.
- Remote programming of the module from PC computer by using the DLOAD10 program.
- RS interface (connecting to computer, INTEGRA or CA-64).
- GPRS monitoring, including the GSM-4 module status and/or control panel events (simulation of telephone monitoring station reading events in DTMF formats).
- Answering the user CLIP (by means of a CLIP, SMS or VOICE message).

* – function available for the CA-64 control panel with v1.04.03 program and DLOAD64 v1.04.04 and GUARD64 v1.04.03 programs (or later versions).

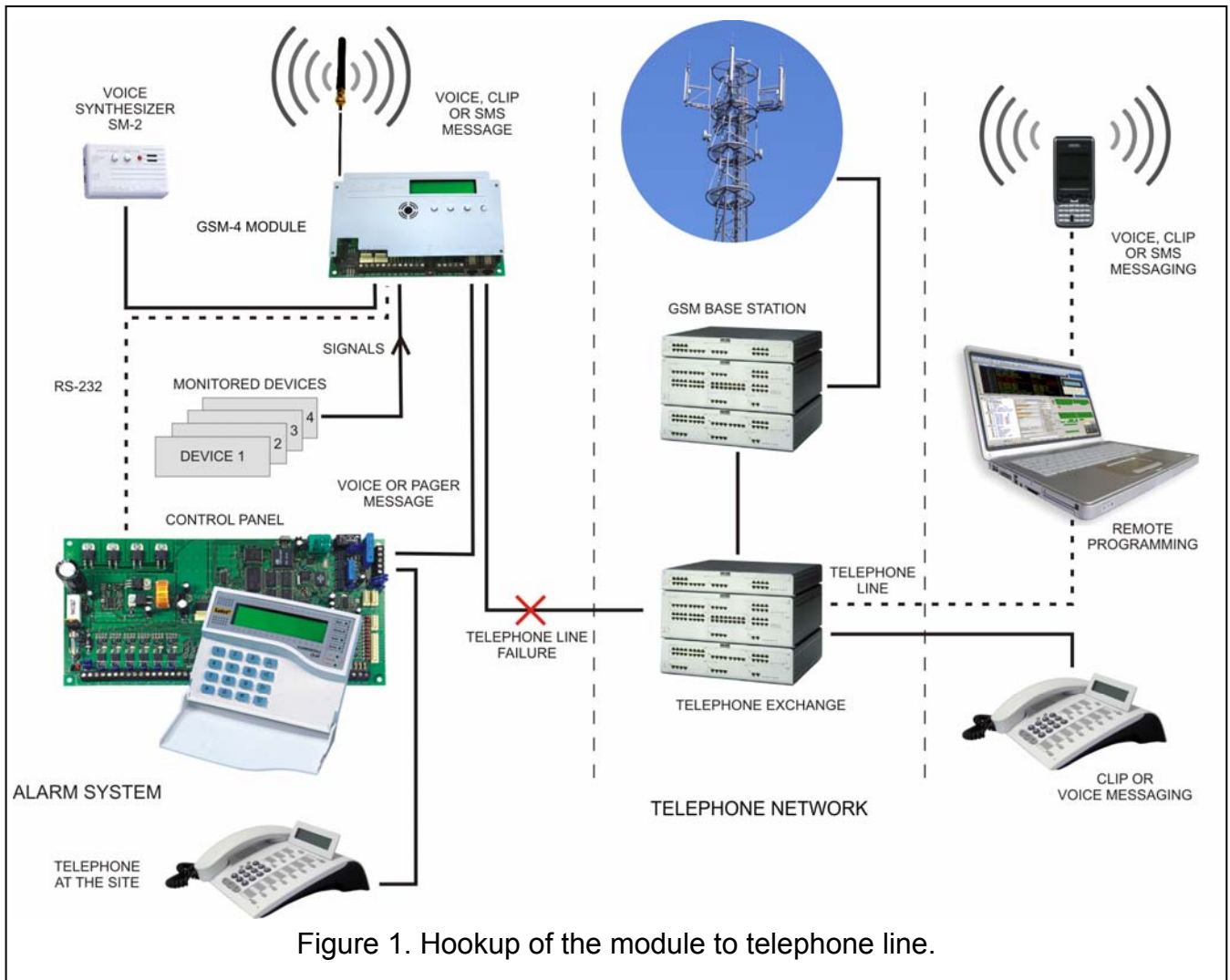

2. LIMITATIONS OF USE

As the mobile phones are designed for the maximum efficiency of speech conveyance, the data compression feature which is used in them brings about distortions in the transmitted audio signals, which may make difficult or even impossible sending modem signals through a simulated telephone line (downloading, monitoring).

Cellular telephones make limitation in using the remote control function by DTMF signals. Not every type of cellular telephone can generate the proper form of these signals. Some models of cellular telephone have a special function permitting the DTMF control – in such case, this special function is to be activated.

The function of remote control by DTMF signals are always available from a traditional, stationary telephone set. The only limitations in this case can result from the quality of telephone cables and the telephone signal level, which reaches the module.

3. DESCRIPTION OF THE MODULE

THE MODULE'S TERMINALS:

TIP, RING – public exchange telephone line (subscriber's line)

T-1, R-1 – extension telephone line (connection to the alarm control panel or to a telephone set)

+ 12V – power supply input

- GND – ground (0 V)
 +V – power output (12 V; max. 300 mA)
 -V – ground (0 V)
 SM2 – socket for the SM-2 voice synthesizer
 IN1–IN4 – the module's inputs
 OT1–OT3 – the controlling output (OC)
 OT4 – output (OC) for signaling the failure of telephone line and/or telephone

Note: The OT3 output can play the role of a telephone line trouble indicator – settings option.

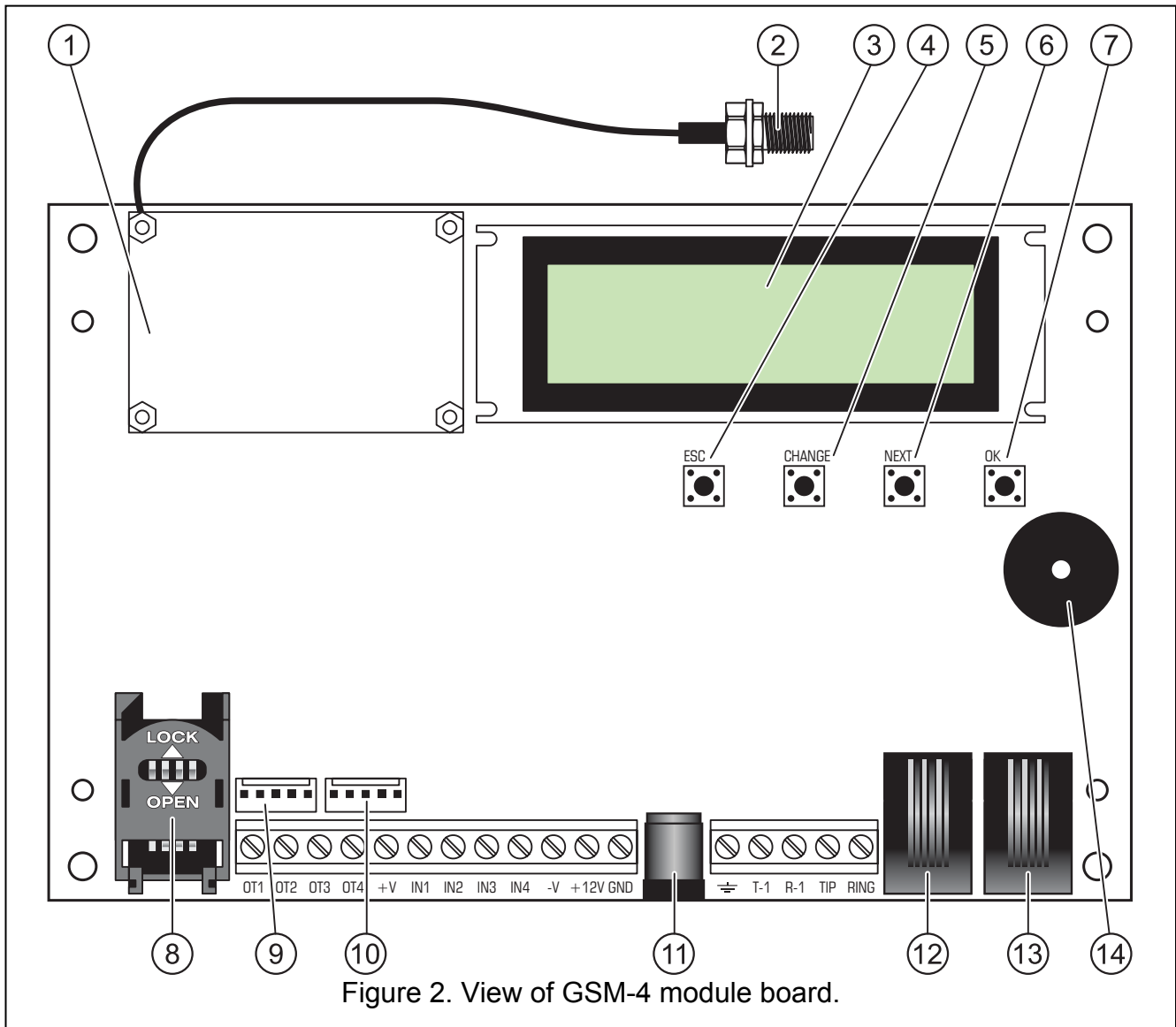

Explanations for Figure 2:

- 1 - **industrial cellular telephone.**
- 2 - **external antenna connection.**
- 3 - **LCD display.**
- 4 - **ESC button.**
- 5 - **CHANGE button.**
- 6 - **NEXT button.**

- 7 - **OK button.**
- 8 - **SIM card socket.** It is not recommended that SIM card be inserted into the socket before the card PIN code has been programmed in the module. If the event codes are to be sent using GPRS technology, the GPRS service must be activated in the SIM card installed in the module.
- 9 - **socket for connecting SM-2 voice synthesizer.**
- 10 - **RS-232 port** which makes it possible to connect the module to the computer (SATEL made cables, available in a set designated DB9F/RJ-KPL, can be used to make the connection).
- 11 - **jack for external power supply unit** .
- 12 - **jack for extension telephone line** (telephone set connection).
- 13 - **jack for public exchange telephone line** (analog trunk line).
- 14 - **buzzer.**

For power supply of external equipment you should use the +V & -V outputs, whose max. current load must not exceed 300 mA. It should be borne in mind, that the capacity of connected power supply unit must be adequate for power demand of the module and the devices connected to it.

The module has the built in LCD display which is used for reading the information on the current status of the module, and for programming the data required during normal operation. In the first line of LCD display (during normal operation), the following information is displayed: the telephone line status, the telephone status, power level of the signal received by antenna (0–4) and the status of the inputs and the outputs of the module. The status of receiving/sending modem data is indicated (R and W symbols). The antenna symbol flashes during the communication of the telephone with GSM base station (during telephone connection as well). In the second line, the information about the current status of the module is displayed (e. g. "Dialing...", "Loss of telephone line...", "Telephone number at dialing..." and others).

Notes:

- *The "**Phone line loss**" message is displayed when cable telephone line (subscriber's line) is not connected to TIP and RING terminals or to LINE socket – this is a normal operation condition in case of the loss of such line. It is possible to disable the function of displaying this message – just deselect the **Show T I.failure** option in the main menu.*
- *The telephone will not start dialing if the antenna signal level is equal to **zero**.*

The status of inputs and outputs are displayed alternately (2 s/2 s) at last four characters of top line on LCD display (counting from the left to the right) in a form of the following symbols:

	SYMBOL	MEANING
INPUT	i	normal status
	t	normal status
	I	violated
	T	violated
	b	bypassed
OUTPUT	o	normal status
	O	active

Table 1

i, I- these symbols refer to the input which can initiate messaging when violated or after the end of violation.

t, T- these symbols refer to the input which will not initiate messaging when violated or after the end of violation. The symbols are displayed when the **TL ok, mess. input n** option is disabled for the given input (n – input number) and the analog telephone line is in good working order.

Normal status of input – status in accordance with the input type (NO, NC) set by the service function.

Input violated – the change of the supervised status occurred, from normal to opposite, for the duration at least equal to the time period defined as the sensitivity of the input.

Input bypassed – the status of the input is not supervised by the module.

Normal status of output – output disconnected from ground.

Output activated – output shorted to ground.

Blinking of the "O" output status indicator means that the output has been enabled for the time programmed with the service function.

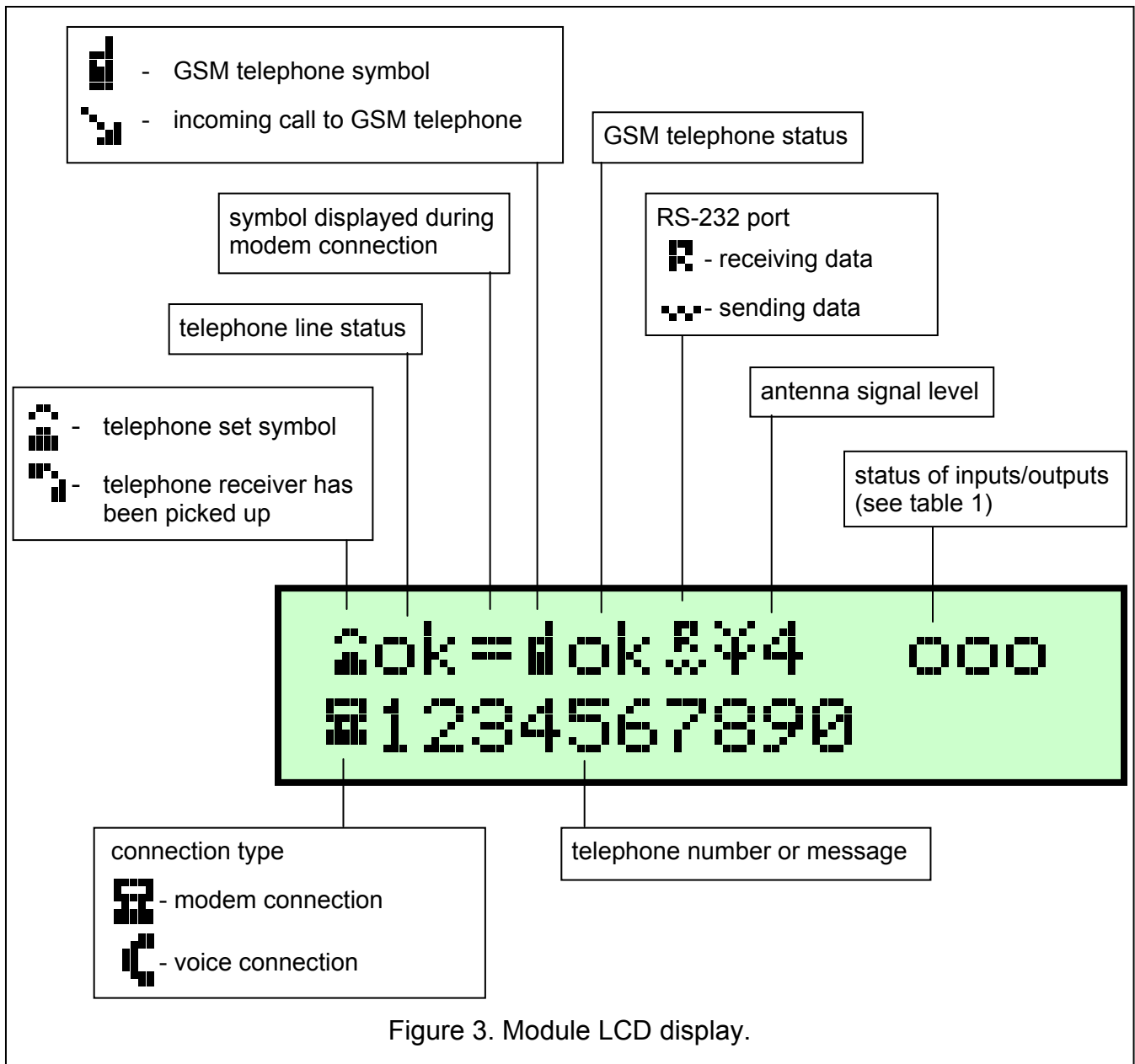

Figure 3. Module LCD display.

Management of SMS text messages is signaled on the module display with the following reports:

- “**SMS sent**” – after transmitting SMS text message via telephone.
- “**SMS received**” – after receiving text message containing SMS password pre-programmed in the module.
- “**Unknown SMS rec.**” – after receiving SMS message not containing the password pre-programmed in the module.

Situated below the display are **four keys** (push-buttons) intended for programming the module and for manually controlling operation of the module inputs and outputs.

Push-button number	Push-button description
1	ESC
2	CHANGE
3	NEXT
4	OK

Table 2

The number of push-buttons given in table above correspond to the number of inputs and outputs during manual control.

Simultaneous pressing and holding for one second both push-buttons, **ESC** and **OK.**, makes the restart of the module, with program version being displayed on LCD display. The restart of the module does not change the status of inputs and outputs. In case of the loss, and then the restoration of power supply of the module, its inputs and outputs are restored to the status before the disconnection of power supply.

The cables of telephone lines: public exchange line (subscriber's) and extension line (to the alarm control panel and telephone set) can be connected to the terminal strip or to the telephone jacks located on the board.

4. OPERATING THE TELEPHONE

The industrial cellular telephone, similar as any other cellular telephone, can be operated by **SIM activation card**. The user of the GSM-4 module and the telephone has to obtain such card. The SIM card is inserted into a special socket provided at the bottom of the printed circuit board. PIN code, if necessary, is entered in the module's memory by the service function from the sub-menu **GSM options**. The change of PIN code or entering PUK code, if needed, is only possible after putting the SIM card into an ordinary cellular telephone.

The cellular telephone set is delivered with special cable fitted, having a connector for external antenna (see fig. 2).

5. INSTALLATION

It should be remembered during installation that the GSM-4 module must not be located in the vicinity of electrical installations, since this may involve a risk of malfunctioning. Pay special attention to how the cable is laid between the module and the telephone jack of the alarm control panel.



Caution: *Never turn on power supply of the module and industrial telephone without external antenna connected.*

The following sequence must be strictly observed while putting the module into operation:

1. Make complete wiring.

2. Turn on power supply of the module without SIM card inserted into the socket on the electronics board – “Set the PIN code” message will be displayed by the module.
3. Activate the service mode of the module and, where the module may have been preprogrammed before, call the **Erase settings** service function (which will restore default settings).
4. Enter the PIN code.
5. Switch off power supply.
6. Insert SIM card into the module (see Fig. 4).
7. Turn on the power supply again and program the module as required.

Notes:

- If the SIM card fails to accept the PIN code, a “Bad PIN, go on? ESC=Stop” message will appear. The module will wait 60 seconds for user reaction, then it will repeat the attempt to send the PIN code. Sending a wrong PIN code three times will disable the SIM card. During the countdown you can press the OK key to immediately resend the code to the card, or press the ESC key to stop the countdown to make possible a change of the PIN code for the right one.
- The “GSM phone trbl.” message is shown on the display until the telephone logs in the cellular network. This state may last up to several minutes from the module power supply being turned on.
- The main reasons why the telephone is unable to log in are:
 - missing SIM card, SIM card inactive or defective
 - insufficient range (antenna signal level = 0)
 - antenna not matched to the network range (900/1800/1900 MHz) or faulty
 - wrong PIN
 - telephone trouble

The module power supply should have sufficient current capacity. The recommended power supply (for example, the SATEL manufactured APS-15 or APS-30) should be equipped with its own battery.

It is suggested that the power supply be located within 3 m from the module.

If the supply voltage is lower than 9.8 V, restart of the module will follow. Therefore, be sure that the module supply voltage never drops during operation below 9.8 V at the maximum current consumption.

6. OPERATION OF THE MODULE WITH ALARM CONTROL PANEL AND STATIONARY TELEPHONE

As shown in Figure 1, the module is to be connected in series between the telephone line (if it is available) and the remaining devices which use the same line. Where a selection option is provided, then, using the appropriate service function, determine which output line (GSM/cable) will be the basic one. The module will test availability of the selected line and in

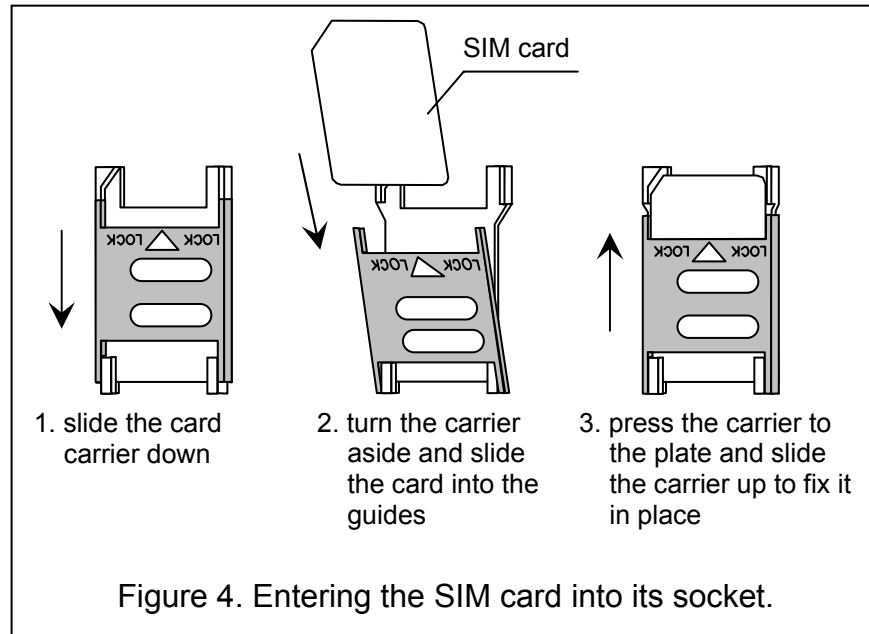

Figure 4. Entering the SIM card into its socket.

case of troubles the calls will be routed through a parallel line. It is possible to disable the function of automatic switchover of the cable telephone line to GSM by deselecting the **Trouble – switch line** option.

The telephone line simulation mode, in which the GSM-4 module takes over the task of handling the devices connected to the T-1 and R-1 terminals, consists in providing across these terminals impedance and voltage required for proper operation of the telephone. At the level of device connected to the module, it is recognized as a typical telephone exchange providing the cable telephone line.

When the control panel is "off-hook", or when a user lifts the handset of a telephone connected to the T-1 and R-1 terminals, the module will generate the continuous dialing tone and receive the tone or pulse dialing signals (similarly as the telephone exchange). If the first four digits of the dialed number correspond to the pre-programmed "*pager station number*", the module goes over to the procedure of receiving the alphanumeric message and sending it as an **SMS text message** (see section **Sending SMS messages**). Checking of the first four digits is always performed.

In case the telephone line is lost or when the GSM telephone has been chosen as the basic connection mode, the module, after receiving the whole telephone number for outgoing connection, makes appropriate corrections to this telephone number, and then initiates dialing and getting connection via the telephone. The corrections are necessary, since the module gets the dialed telephone number as when connecting via the cable telephone network, while the connection through a cellular telephone requires area codes to be given. The principles of conversion are described in one of following sections. When the cellular telephone gets connected, the module transmits L.F. audio signals between the extension line T-1 and R-1 terminals and the cellular telephone. If the antenna signal level drops to zero during the communication, the connection will be terminated by the module.

In case the telephone cable line is operative and has been chosen as the basic one, signals from the telephone set (T-1, R-1) are directly transmitted to the telephone line terminals (TIP, RING).

The voice messaging initiated by the alarm control panel is effected in a manner selected as the basic one (if this is impossible, the module selects a substitute way).

When making a call from the telephone connected to the GSM-4 module, the user has **the option to select the connection route: via cable or via GSM**. Lifting the handset makes the basic line available for getting connections. Pressing the FLASH key on the telephone will change the output line from the basic one to the substitute one (GSM to cable or cable to GSM). This function of the module is set up by means of the **FLASH – GSM/TL** service function.

After the handset is lifted by the subscriber the connection is made with, the module changes the direct voltage polarization across the T-1, R-1 extension line terminals. This function makes it possible to keep individual tariffication of telephone calls.

Since the industrial cellular telephone, has its own number (SIM card number), there is the possibility of calling to this number. **The incoming calls** to the cellular telephone are transferred to T-1 and R-1 terminals of extension line, and the ringing tone will be generated – similar as during making connection via cable telephone line. It is then possible to answer the incoming call by a telephone set connected to this extension telephone line. The number of incoming call will be shown on the display.

The capability of answering the calls is utilized for remote controlling the status of outputs and for bypassing and unbypassing the inputs of the module. The possibility of receiving and sending SMS text messages via the industrial cellular telephone is used for the some purposes. The function of remote control is described in one of following sections.

The module also uses the CLIP for messaging as well as for controlling the outputs.

7. GSM-4 WITH MONITORING STATION

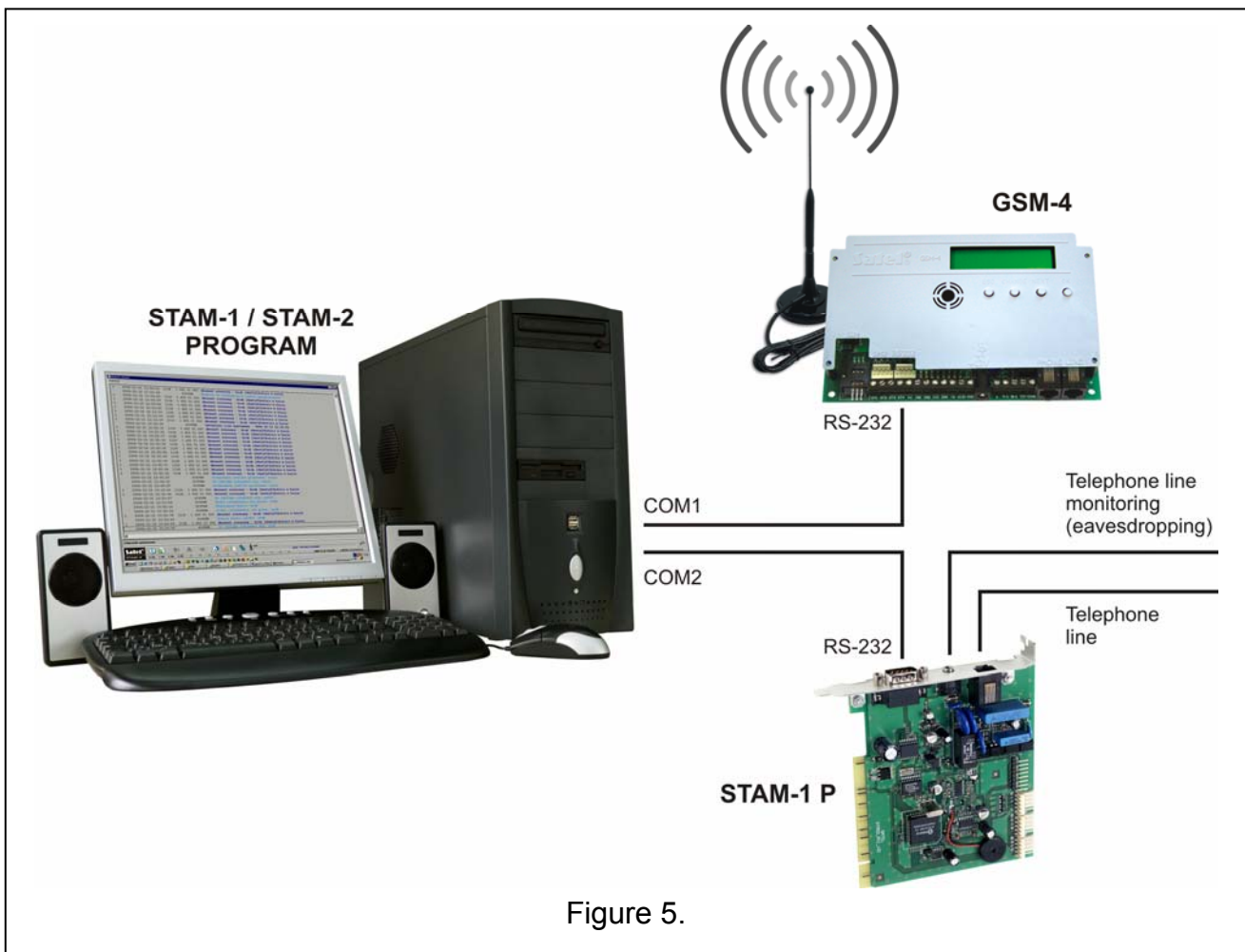

The GSM-4 module enables monitoring of sites by means of SMS short text messages.

The STAM-1 monitoring station (from version 4.07) only supports SMS monitoring related to the input status of the GSM module located on the site (e.g. GSM-4 or GSM LT-2). Changing the status of the device inputs will result in sending the event as a preprogrammed contents SMS message to the GSM module number on the monitoring station side. The SMS message contents and the corresponding codes are to be defined in the STAM program when editing the client.

The STAM-2 monitoring station (from version 1.2.0), besides monitoring of the status of module inputs, enables also full monitoring of events from the interfacing alarm control panel. The panel is sending all events as SMS messages, the format of which (CID or 4/2) is to be programmed by means of the DLOAD10 program (see: **Monitoring**).

An example of the module connection to station is shown in Fig. 5. The GSM-4 module should be connected to the computer serial port (COM1 or COM2) with a cable shown in Fig 8. Such a cable, designated with the DB9F/RJ-KPL symbol, is available in the SATEL's offer.

8. DESCRIPTION OF OUTPUTS AND INPUTS OF THE MODULE

The GSM-4 module is equipped with three outputs and four inputs of the technical features similar to those of inputs and outputs of the alarm control panel. The attendance of the outputs consists in controlling their operation (switching on for a programmed time period or permanently or changing their status), while attending the inputs is connected with

supervising their status and with monitoring the changes of any status. The supervision of inputs can be bypassed.

The attendance of outputs and inputs is performed by the module irrespective of attending the telephone line.

8.1 OUTPUTS

The GSM-4 has 3 outputs (type OC, current carrying capacity **50 mA**), which can be used to control operation of electrical devices.

The status of outputs can be controlled **locally (manually)**, with the use of module buttons, or **remotely** – by telephone (through **DTMF**, **SMS** or **CLIP**). The change of output status can also be triggered by **input violation**.

The output can take one of the following logic states:

"0" output disabled – **normal state**,

"1" output enabled – **active state**.

The status of outputs may be changed in the following way:

- enabling output – if inactive, the output will be switched on; if active, the output status will not change. If a cut-off time has been programmed for the output, it will be disabled after the time expires. When the output is active, further commands of the "switch on output" type will start the cut-off time countdown again.
- disabling output – if active, the output will be disabled, no matter whether it is permanently enabled or its cut-off time has been programmed. If inactive, the output will not change its status.
- changing over output – the output state will be changed to the opposite one (0 -> 1, 1 ->0).
- simultaneous disabling of all outputs – all outputs will be deactivated, irrespective of their previous status.
- simultaneous enabling of all outputs – all outputs will be activated, irrespective of their previous status.

Notes:

- *The control of outputs is possible upon programming the appropriate service functions (submenu: **SMS control**, **DTMF control**, **CLIP control**).*
- *If the OT3 output is used as a telephone line trouble indicator, it cannot be controlled.*

8.2 INPUTS

The detectors of both types, **NC** and **NO**, can be connected to the module. The type of detectors is to be entered in the service function.

The first parameter, **the sensitivity of the input** is programmed for each input. The sensitivity of the input is defined as a minimum time which must elapse from the moment of the status change at the input (isolated from ground for NC input, shorted to ground for NO input), in order to classify such change as violation of the input. This time delay can have the values within the range from 20 ms to 1275 ms.

The time to **restore the input** is the next parameter to be programmed for each input. Time to restore the input is defined as a time period that must elapse from the end of input violation to the moment when the module the input can register a next violation (4 seconds or 4 minutes).

Controlling the operation of inputs consists in **bypassing** and **unbypassing** their operation. This control can be performed **manually (locally)** or **remotely**. The manual bypassing option can be disabled by deselecting **IN1 bps.manual** option. The remote control is implemented similarly to the remote control of the module outputs status.

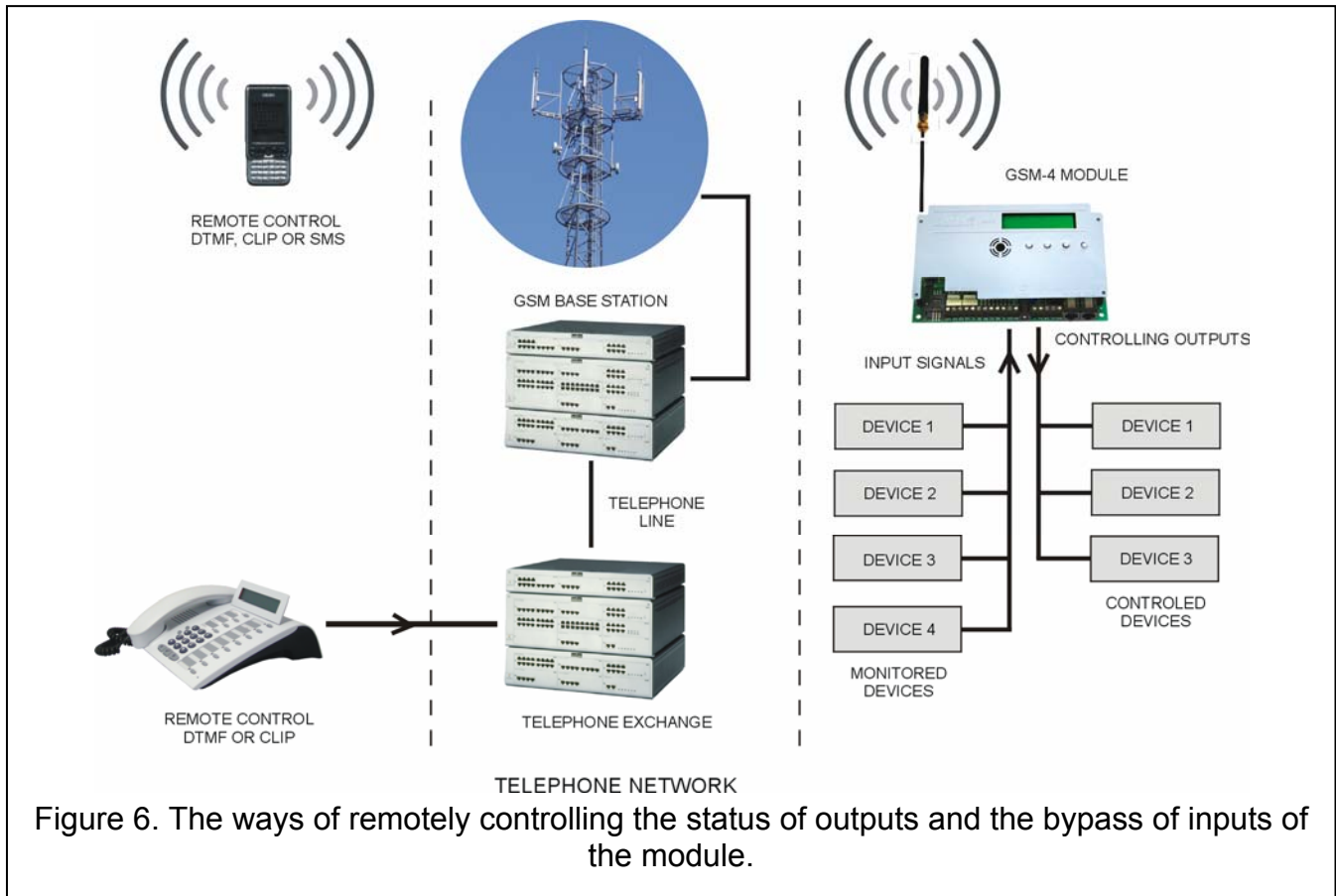

The input can be **automatically** bypassed after one violation or after three violations of such input (set by the service function), or after violating another input (designated as the bypassing input).

After preset number of violations, the input will be **automatically** bypassed after termination of the last violation of the given input (i.e. after normal status of the given input is restored).

The bypassed status of the inputs as a result of violating the **bypassing input** will last as long as the given input is violated.

9. METHODS OF CONTROLLING THE STATUS OF THE OUTPUTS AND BYPASSING THE INPUTS

Changing the state of outputs and bypassing the inputs of the GSM-4 module can be effected remotely (by tone from telephone keypad, by SMS message, through CLIP), locally (using the module keys, by tone from terminals T-1, R-1), and also by violating the selected input.

9.1 REMOTE CONTROL

9.1.1 Tone control from telephone keypad

To have the remote control by dual tone phone push-button, it is necessary to properly program the module by using the service functions, as follows:

- Set the required **Time of ringing** (keep in mind that for value "0" the module will not answer any calls, thus making control through DTMF impossible),
- Program **codes** (4 digits) for controlling the status of outputs and for the bypass of inputs. The contents of the controlling codes are loaded into the module's memory by the service functions contained in the submenu of the service mode **DTMF control**. The codes may

not recur. To erase the code completely (to disable a given function), simultaneously press push-buttons CHANGE and NEXT.

For remote controlling the status of the outputs or bypassing/unbypassing the inputs follows the sequence:

- Dial the industrial cellular telephone number from any telephone having DTMF features.
- Wait until "*time of ringing*" is completed after which the module will answer a call and generate three short sounds (beeps) acknowledging that the module is ready to have the DTMF controlling.

Note: *When receiving a call, the module applies ringing tone to extension line for the duration equal to "time of ringing". Answering a call from this extension line makes it impossible to bypassing/unbypassing.*

- Enter from dual tone phone keypad the required control code (utilizing DTMF tone signals). After recognizing the code by the module, the respective action will be taken, depending on the code loaded. For example, recognizing the code loaded in the module by the function **DTMF OT2 on** will switch on the OUT2 output, while recognizing the code programmed by the service function **DTMF bypass IN4** will bypass the supervision of input 4.
- The module acoustically acknowledges the execution of the function by audible indication as follows:
 - **three short beeps** – switching OFF the output (disconnecting the ground), the signal will also acknowledge execution of the function **DTMF OT123 off** (disabling all outputs simultaneously),
 - **four short and one long beeps** – switching ON the output (short circuit to ground), such signal also acknowledges the execution function **DTMF OT123 on** (switching ON all outputs),
 - after bypassing/unbypassing the input, the module automatically checks the status of the inputs and generates **four sounds** corresponding to the status of consecutive inputs (1–4):
 - **short** beep – input unbypassed,
 - **long** beep – input bypassed,
 (for instance: the sequence of signals – short, long, short, long indicate that inputs 1 and 3 are unbypassed, and inputs 2 and 4 are bypassed),
 - **two long beeps** – the code is unknown to the module.
- Enter the next control code or terminate the connection.

The additional feature of the DTMF control function is **the capability of checking the status** of the outputs without necessity of switching these outputs. To obtain such a possibility, enter from a telephone keypad the code programmed by the service function **DTMF check outs**. After reading the code, the module generates the sound signals indicating only these outputs, which are ON (with the exception of situation when all three outputs are OFF):

- one short beep – output OT1,
- two short beeps – output OT2,
- three short beeps – output OT3,
- four short and one long beeps – all three outputs are OFF.

For example: if, after entering the code, one beep is heard in the telephone receiver, and then after a while three beeps are heard, it means that the first and the third output (OT1 and OT3) are ON, and the second output (OT2) is OFF.

Note: *In case of errors while entering the code, press push-button * or # and enter the code from the beginning. A triple attempt of entering the code, which is unknown to the module results in a loss of connection – the module will "hang up".*

9.1.2 Remote bypassing by SMS messages

The remote control by SMS text messages is enabled by entering appropriate password in the module's memory (6 alphanumeric characters). The contents of the control passwords are loaded in the module's memory by the service functions contained in the submenu of service mode **SMS control**. The passwords can not recur. To erase to password completely, simultaneously press push-buttons CHANGE and NEXT.

To have this control feature enabled, send to a text message containing the required control password to the industrial cellular telephone number. After decoding the password by the module, an appropriate action will be initiated, depending on the password transmitted. E.g.: recognizing the password entered into the module memory by the function **SMS OT3 on** will enable the OT3 output for the time entered into the module memory with the function **OT3 cut-off t.**, or permanently, if the time is zero. Recognizing the password entered in the module's memory by the function **SMS unbyypass all** will result in unbyypassing all module's inputs which were bypassed.

It is possible to send to the module an SMS message containing the code alone, as well as a message longer than the code itself it can be part of a longer word – among the 32 first characters. Thus a verbal description of the current of the current operation can be placed into memory of the telephone, from which the control will to be executed (SMS sent). This will relieve the user from the necessity to memorize the codes or the functions realized by them.

Only one control code can be sent in one message. If there are more codes, only the first one will be executed by the module. Sending an SMS message which contains no code (or contains a wrongly entered code) will cause no response from the device. The control function is executed as soon as the message is received and the control code recognized. Once the function has been executed, the received message will be deleted and the telephone will be ready to receive a next control SMS message.

9.1.2.1 Acknowledgement of executing the SMS control

If the number to be used for acknowledging the SMS control and SMS centre number are pre-programmed in the module's memory (functions: **SMS acknowl. No.**, **SMS centre No.**), then after executing the control of individual output by SMS message, the GSM-4 module sends the message confirming the type of control and the present status of outputs. The acknowledgement can also be sent to another telephone number. For the module to forward an SMS to a different number than that programmed in the module, it is necessary to insert this number after the control message in the following way: "xxxx=yyyy.", where "xxxx" denotes the control code, and "yyyy" – the telephone number to which the message is to be sent by the module. Put the equality sign before the telephone number, and the dot after the telephone number.

Controlling all outputs simultaneously or bypassing/unbypassing the inputs is confirmed by the message on the present status of all inputs and outputs of the module as well as the telephone line status, level of the signal received by GSM antenna, test transmission period and current telephone numbers to be notified. The message transmitted by the module can have one of the following forms:

- OUT [n] switched ON (status: OT1 = ? OT2 = ? OT3 = ?)
- OUT [n] switched OFF (status: OT1 = ? OT2 = ? OT3 = ?), when character "[n]" is replaced with the output's number: 1, 2 or 3.
- Status: IN1 =?, IN2 =?, IN3 =?, IN4 =?, outputs: OT1 =?, OT2 =?, OT3 =?, LT=?, SIG=?, test: ??d??h??m Tel1=?...? Tel2=?...? Tel3=?...? Tel4=?...?

For designation of the **output** (OT1 – 3), character "?" is replaced with the logic state (i. e. the status) of the output:

- 0 – output switched OFF (inactive),

1 – output switched ON (active).

For designation of **inputs** (IN1 – 4), character "?" is replaced with the letter:

- i or t – input in normal status unbypassed (non-violated),
- I or T – input unbypassed violated,
- b – input bypassed.

For the **telephone line** (LT) designation, the "?" character is replaced with the following ones:

- ok – the telephone line in good working order,
- ?? – the telephone line out of order.

For description of the (SIG) **signal level**, the "?" character is replaced with digits from 0 to 4.

In the **test** field, the module will send the currently programmed number of days, hours and minutes of the test transmission period.

In the **telephone number** (Tel1 – 4) description, the ?...? characters are replaced by the programmed telephone number to be notified.

Note: *The module always acknowledges the stable status, in which the output remains after completing the control (for the monostable switched output – the status in which the output will go after the switching time expires).*

9.1.3 Controlling outputs by means of CLIP function

The module allows you to control the outputs by using the CLIP feature. To this end you should call the module number from a corresponding telephone number. The module will decode the number from which the connection is initiated, count the "*calling time*", reset the connection and perform control. If the module user answers the call earlier from the extension line (T-1, R-1), or if the calling party hangs-up, the function will be interrupted and the control will not be performed.

An option is provided to save 4 telephone numbers in the module memory and assign to these numbers suitable control of one output or some outputs simultaneously. Operating mode of the outputs is much the same as for control of the **zone violation**.

In order to start the CLIP control function, you should:

- program the **Calling time** (keep in mind that for value "0" the module will not answer any calls, thus making control through CLIP impossible),
- program the functions from the **CLIP control** submenu (telephone numbers, way to control the outputs).

Notes:

- *In some GSM networks the unanswered calls are, after elapse of a certain time delay, automatically transferred to the voice mailbox. If the "calling time" is longer than the call transfer time, the control will not be performed. If this is the case, you should limit the "calling time" so that the module can reset the connection by itself and perform the control.*
- *In order to fully utilize the CLIP control idea and to control the outputs without paying the charges for telephone connections, you should disable the voice mail function. Rejection of a call with enabled voice mail service will divert it to the voice mailbox, the call being counted as realized. The call charge is borne by the calling party.*

9.2 LOCAL CONTROL

9.2.1 Control by using module keys

During normal operation, pressing and holding one of the module's push-buttons for the duration of 1 second will result in enabling/disabling the output, the number of which

corresponds to the push-button's number. The message on the output's status is displayed on the LCD display and the module simultaneously generates the sound signal identical to that during remote control by DTMF signals. If the output is enabled permanently, it is indicated on the LCD display by the "O" character, and if disabled – by the "o" character. If the output is enabled for a specified time, the "O" character is blinking.

The following push-buttons are used for controlling the status of outputs or for bypassing/unbypassing the inputs:

ESC	– controlling OT1 ;	bypassing IN1
CHANGE	– controlling OT2 ;	bypassing IN2
NEXT	– controlling OT3 ;	bypassing IN3
OK	– switching OFF all outputs ;	bypassing IN4

The manual bypassing/unbypassing the inputs is also implemented by the GSM-4 module's push-buttons. Pressing one of these push-buttons three time will cause bypassing the input of the number corresponding to the number of a given push-button (see: description of module's push-button). The bypass of this input will be confirmed on LCD display by displaying character "b" in the field indicating the status of a given input, and by displaying the **INn bypassed** message, where n = 1,2,3,4 corresponds to the input's number. At the same time three short beeps are generated. If this input has been already bypassed, the execution of this operational sequence will result in unbypassing this input. Unbypassing should be acknowledged by changing the indication of the input's status, by displaying the message "**INn unbypassed**" and by audible signals (four short and one long beeps).

The function of manually bypassing particular inputs can be disabled. To do so, deselect the **INn bps.manual** option, where n denotes the input number. The inputs can be manually bypassed at all times.

9.2.2 Tone control from terminals R-1, T-1

In order to make possible bypassing/unbypassing the inputs and enabling/disabling the outputs, you must program the module accordingly:

- Enter the device service mode.
- Using the **IN1–4 bps.manual** function, indicate the inputs to be bypassed/unbypassed locally.
- Using the **Controllable out.** function, indicate the outputs to be controlled locally.
- Using the **Control** function, program a six-character **control code** to make possible bypassing/unbypassing the inputs and enabling/disabling the outputs.
- Hang up to exit the service mode.

In order to bypass/unbypass the input or enable/disable the output from terminals R-1, T-1, do the following:

- Pick up the receiver and enter the **control code** (if correct, the device will generate four short beeps and a long one).
- Bypass/unbypass the input, following the procedure described in the **Control** function.

Hanging the receiver up will restore normal, operating mode of the device.

9.3 CONTROLLING INPUTS AND OUTPUTS BY THE VIOLATION OF INPUTS

The violation of input, besides the telephone messaging, can also result in activating one or several inputs/outputs simultaneously. To initiate such control it is necessary to program functions: **Bypassing in.**, **Bypassed in.**, **IN1–4 -> Outputs**.

This control can result in:

- Bypassing the input(s).

- Enabling output – if a cut-off time has been programmed for the output, it will switch on for the time specified.
- Changing the output status.
- Disabling output.

10. MESSAGING

This function is related to the attendance of module's inputs, and is activated by violation or restoration to normal status (termination of violation) of the input, which is not bypassed. Activation of output OT4 or its restoration to normal status, can also initiate messaging, similar as for input.

Messaging will only be effected through the industrial mobile phone, maximally to four telephone numbers. The messaging can have a form of SMS message, the sound information or CLIP type information. For the voice messaging, it is possible to initiate the function of calling a given number twice (two phone connections with replaying the message each time).

Another form of messaging is the "test transmission". In order to inform the user of its operability, the module will send an SMS with suitable contents, or call selected telephone numbers within the programmed time period. Information on the status of outputs, inputs, and telephone line availability can be attached to the SMS message.

Checking the current module status is also possible, owing to the **CLIP -> Tel.** option. It will suffice to dial the industrial telephone number and hang up after a few call signals. A moment later the module will generate an additional test transmission (independent of those already programmed), i.e. it will send to the calling number an SMS message, CLIP signal (one-time, not requiring acknowledgement) or a voice message.

It is possible to disable the function of messaging individually for each input, if the cable telephone line is operative: messages will only be sent by module if the cable line is damaged. In order to do so, deselect the **TL ok, mess.Input n** option for the selected input, where n means the number of input. The status of such inputs will be indicated with "t" or "T" letter on LCD display and in SMS messages, provided that the telephone line is OK. However, when the analog telephone line is out of order, these symbols will change into "i" or "I", which means that messaging from those inputs will be effected.

The telephone numbers to be notified and the test transmission period can be remotely changed by sending SMS messages to the module. Such messages must contain the proper password and the programmable parameter (see: **Description of service functions**).

10.1 SMS MESSAGES

The SMS messages to be transmitted can have standard contents or can be modified by the user. The user's own message can be entered by using the module's push-buttons or by utilizing the SMS message sent from another telephone to the industrial telephone number. The contents of messages are entered by special service mode functions (submenu **Messaging**) or from the DLOAD10 program.

To change the contents of a standard message by using the module buttons, it is necessary to follow the steps:

- Initiate the service mode.
- Go to submenu **Messaging**.
- Select appropriate function for programming the contents of SMS message.
- Read the present contents of the message, after recalling the selected functions. By using push-buttons NEXT and CHANGE it is possible to enter your own contents of SMS message regarding the event which corresponds with the function's description.

- Accept the introduced changes by pressing push-button OK, and proceed with programming the next message, or abort the operation of service mode.

To enter the contents of the message by means of another cellular telephone, it is necessary to follow the sequence:

- After recalling the function for programming the contents of a message, simultaneously press and hold push-buttons NEXT and CHANGE.
- If the contents of present message are standard, the information "*Read-out from SMS*" will be displayed on LCD display, and the module will go into "awaiting for SMS message mode" for the duration of approx. 110 seconds.
- Send SMS message (previously prepared) from another cellular telephone to the industrial telephone number. The message to be sent should be of a special format. The contents of the message, which is to be loaded into the module's memory should be put into brackets and closed by asterisks, as follows: (***Contents of message***).

Notes:

- *If, after recalling the function, the contents of the displayed message is not standard, pressing and holding the push-button NEXT and CHANGE will cancel this message, the next pressing will result in displaying the standard message and only the successive pressing will make it possible to load the message by means of SMS message.*
- *Both push-buttons must be pressed simultaneously, otherwise the module will enter the mode for manual editing the message and it will be necessary to renew the procedure for reading the message from SMS.*
- **The length of the message stored in the module's memory is limited to 32 characters.**

The standard contents of the transmitted SMS messages are as follows:

"Input n violation"	}	for inputs; where n = 1,2,3,4
"Input n restore"		
"Phone line failure"	}	for output OT4
"Phone line restore"		
"Test message"		

10.2 VOICE MESSAGING

If the SM-2 voice synthesizer with recorded voice message is connected to the module, the violation of any input and its restoration or activation of output OT4 and its restoration can initiate sending this message to the selected telephone numbers. When sending the message, the module will display corresponding information. Since the module can transmit only one voice message, it is also possible to activate **the sound signaling** for indicating the reason why the messaging was initiated.

After getting connection, the module generates the respective sequence of sounds every 2 seconds:

1 short beep	– violation of input 1,
2 short beeps	– violation of input 2,
3 short beeps	– violation of input 3,
4 short beeps	– violation of input 4,
2 short and one long beep	– activation of output OT4,
1 long + 1 short beep	– restoration of input 1,
1 long + 2 short beeps	– restoration of input 2,
1 long + 3 short beeps	– restoration of input 3,

1 long + 4 short beeps	– restoration of input 4,
1 long, 1 short, 1 long beep	– restoration of input OT4,
2 long beep	– test message.

10.3 CLIP

Notification messaging is also possible owing to the CLIP service which consists in displaying the telephone number of the calling subscriber. This type of messaging consists in dialing a programmed telephone number by the cellular telephone and then breaking the connection after approx. 20 seconds. The message recipient can read number of the telephone from which the connection was initiated (cellular phone, ISDN, etc.).

If the selected number is busy, the module will repeat the call. The module will consider the messaging completed, if it does not receive the busy signal within approx. 10 seconds from dialing the number. The cellular phone user has an option to early "reject" the connection, but if he carries out this action too early, the module will repeat the call. Answering the call, either by the user or automatically by the "voice mail", is recognized by the module as completion of messaging.

10.3.1 CLIP with acknowledgement

The transmission acknowledgement consists in the telephone user rejecting or receiving the connection set up by the GSM-4 module. The acknowledgement may only come within 10 to 20 seconds of the connection set-up. In addition, the number of attempts (1–15) to transmit the information can be programmed individually for each telephone number. Having detected the acknowledgement of CLIP information reception, the module will finish dialing the given telephone number. The module will call in turn each of the programmed numbers. Having detected the acknowledgement of CLIP transmission, the module will finish dialing the given telephone number.

For each of the four telephone numbers to be programmed to be CLIP notified, you can select a separate option of sending SMS if there is no acknowledgement of receiving the CLIP information. If the module fails to detect such an acknowledgement after making a preset number of attempts, then it will send an SMS to the given telephone number, provided that the messaging mode with acknowledgement and SMS send is selected. The SMS contents will correspond to the existing situation.

10.3.2 CLIP without acknowledgement

In the "without acknowledgement" transmission mode, the module will dial the given telephone number once (provided the number is not busy), irrespective of the programmed number of test transmission attempts.

Notes:

- *If the cellular phone of the message addressee is OFF or outside the network range, and the voice mail service is inactive, then an automatic message on the existing situation is generated in the receiver and no busy signal is sent back. In such a case, the messaging is considered by the module as completed, while the user loses information on completion thereof.*
- *If the voice mail service is active, the user, after getting access to the network, may be notified, depending on the operator (e.g. by means of an SMS) of the telephone connection with the module number, without leaving any voice message.*
- *If the "CLIP with acknowledgement" messaging mode is not selected, the module, to execute the function, will call the selected telephone number once (unless the given number is busy), irrespective of the programmed number of redials.*

To enable the messaging, it is necessary – after switching ON the industrial telephone and connecting the sensors to the inputs – to program the module (submenu of service functions: **Messaging, Inputs/Outputs, GSM options**), as follows:

- Program at least one telephone number to which the message is to be transmitted (**Tel. 1 for mess. 1–4**).
- Determine if the output OT4, or if the inputs after violation or restoration will activate the messaging function (to which telephone number), and/or if the test messaging will be active, and also determine the way of messaging (SMS/CLIP/VOICE) – functions: **In. 1–4 -> Tel.; Rest. 1 -> Tel.; F. L. -> Tel.; Rest. L. Tel.; Test -> Tel.**
- If the voice messaging is selected, and several inputs can activate this messaging – set the option **Mess. sounds** to distinguish which input was violated.
- Program the required parameters for the inputs (**type, sensitivity, time to restore, automatic bypassing**).
- If the SMS messaging is selected, program the function **SMS Centre No.** and the SMS message texts.

11. TRANSMITTING SMS MESSAGES

If the alarm control panel has the function for messaging to pager system, it can be used for sending SMS messages.

To enable the SMS messages to be sent, pre-program telephone number of pager station at the alarm control panel and load appropriate text to be sent into the control panel memory.

The telephone number, as programmed in the control panel, must consist of:

1. The "pager station number" preprogrammed in the GSM-4 module (**Pager tel. No.** service function).
2. The cellular phone number to which the SMS message is to be sent. The required country code prefix can be entered before the basic cellular phone number, or it can be programmed by the separate **Prefix for SMS** function.
3. The "A" end-of-number character.

Note: *Parts of the number may not be separated from each other by any time interval (pause); the digits must be sent by the control panel as one sequence in DTMF or pulse mode. In case the module has any trouble with receiving the "pager" station number in the tone mode, it is necessary to set the **pulse dialing mode** in the control panel.*

11.1 DESCRIPTION OF THE PROCEDURE FOR CONVERTING PAGER MESSAGE INTO SMS MESSAGE

When the alarm control panel is "Off Hook" and after dialing the number – the module checks the first four digits of that number. If these digits agree with the programmed "**Pager tel. No.**" In the module, the module receives next digits up to the pause (telephone number to which SMS message will be sent); then the module sends handshake signal (similar as pager station) and receives the message sent by the control panel. Next, this message is transmitted via the industrial cellular telephone as SMS text message.

Notes:

- *The pager station number has the form of 4 optional digits for module firmware version 4.11 and earlier. For module firmware version 4.12 and later, the pager number is a sequence of 1 to 4 optional digits.*

- *Pager number must be unique and can not be the same as any prefix, outgoing numbers or the beginning of other telephone numbers.*

For the SMS messages to be sent, it is required to add the prefix with a country code (48 for Poland). This prefix is programmed by the service function **Prefix for SMS**. If the cellular telephone number is given by the control panel together with prefix, the function **Prefix for SMS** should not be programmed.

To enable the transmission of SMS messages, the SMS centre number is to be loaded into the module's memory by the service function **SMS centre No.**, depending on GSM network in which the telephone is activated.

The parameters of the pager system signal should be **programmed at the alarm control panel** (or telephone set DT-1) as follows:

control panel	1	C	2	2	0	A	0	E	7	0	8	A
DT-1	C	1	2	2	A	0	E	0	0	7	A	8

11.2 SENDING SMS MESSAGES FROM A STATIONARY TELEPHONE SET

The GSM-4 module user has an option to send SMS messages form a stationary telephone set which generates DTMF signals and is connected to the terminals R-1 and T-1.

1. In order to send an SMS you should:
2. Lift the handset of the telephone. Dial in one sequence the "PAGER station number" and the phone number to which the SMS is to be sent. The number should be entered rather quickly, without any time intervals between consecutive digits (the country prefix should be indicated depending on the programmed **Prefix for SMS** function).
3. The properly received number is acknowledged in the handset by two beeps generated by the module. Lack of acknowledgement or a busy signal means a dialing error and then the procedure must be started anew (to facilitate it, you can use the REDIAL option).
4. Enter the text of message following the instructions below (the time of module waiting for subsequent characters is not limited):

The module will accept characters in the numeric mode. Pressing each key of the telephone adds a corresponding digit to the message.

By pressing the [*] key twice you will enter the text mode. In the text mode, each numeric key (from 1 to 9) has three letters assigned to it (see Fig. 7). Pressing a key means selection of the middle letter. By pressing in turn the key and [*] you will select the left-hand letter on the given key. The right-hand letter is accessible by pressing the given key and [#]. In order to reach the space, press the [0] key. To reach the dash, press [0][*], the point – press [1]. In order to change between the text mode and the numeric mode, press the keys [0] and [#].

Pressing the [#] key when the module is in the numeric mode results in ending the programming and sending the message.

The GSM-4 module can store in its memory 62 alphanumeric characters to be sent as an SMS message. At an attempt to enter a longer message, the excessive portion of the text will be omitted. There is no possibility to check the content of entered message. If you hang-up the handset when entering the text, the function will be interrupted without sending any SMS.

Q . Z 1	A B C 2	D E F 3
G H I 4	J K L 5	M N O 6
P R S 7	T U V 8	W X Y 9
*	- _ 0	#

Figure 7. Assignment of alphanumeric characters to telephone keypad.

11.3 THE RULES FOR CONVERTING THE NUMBERS

In case when the GSM-4 module operates in telephone line simulation mode, the number received from the alarm control panel or normal telephone set (before sending it to industrial cellular telephone) is subjected to the required corrections. Thus, it is not necessary to take the connection route into consideration, while programming the telephone number for messaging or during dialing the number at normal telephone set. The built-in algorithm of the number conversion permits the module to be installed directly on subscriber's line (public exchange telephone line) or on extension lines as well. If such line is cut off or lost, the module will simulate the operation of PBX exchange and after receiving the number of "outgoing line" the module will simulate the access to public exchange telephone line.

The telephone number is processed by the module as follows:

- When dialing the number, the module checks that its first digits correspond to the pager station number, or any of the "outgoing numbers".
- 4 seconds since dialing the last digit, the module will recognize the dialing as completed and will proceed to convert the number. If an "outgoing number" has been selected, only the digits directly following the number will be subjected to conversion.

The algorithm of converting the number is as follows:

1. if the dialed number begins with one of permanent prefixes (prefix – digits added before the exact telephone number), the module skips to step 4,
2. if the dialed number begins with a "prefix to be erased" this prefix is erased and the module skips to step 4,
3. if the dialed telephone number have no prefixes known to the module, **Prefix to be added** is entered to the beginning of the dialed number, and the module skips to step 4,
4. if the dialed telephone number, after correcting in steps 1–3, is included in the list of allowable numbers (**Allowed numbers**), or if the first digits of the dialed number correspond to one of the pre-programmed numbers, or if the option **Any numbers** is set - the number is recognized as the correct one, and the module starts to make connection with the dialed telephone number via the industrial cellular telephone. Otherwise, the connection is disabled and a busy tone is generated.

12. MONITORING

The GSM-4 module enables operation with two independent monitoring stations (using GPRS transmission, SMS messages or audio channel). For this purpose it is necessary to program the transmission parameters. It can be done from a PC with DLOAD10 program (from version 1.00.031, tab: **GPRS/Monitoring**) or by using the module board buttons (**Service mode menu → GSM options → GPRS settings**).

Reporting to the monitoring station can include:

- GSM-4 module status,
- events from the control panel.

Note: Enabling the GPRS reporting option will disable the option of sending pager/SMS messages.

12.1 MONITORING GSM-4 MODULE STATUS

Monitoring the module status is possible both when the module is working independently of or in conjunction with the control panel.

The module is sending events pertaining to the **status of inputs IN1–IN4** (violation/end of violation) **status of telephone line** (line trouble/line restore), as well as the **test transmission**. The information can be sent in the **4/2** or **CID (Contact ID)** format.

12.2 MONITORING CONTROL PANEL EVENTS

Beginning from PCB version 1.7S, the GSM-4 module enables full-scope reporting of the control panel events to the monitoring station. It can be connected to the control panel telephone output (TIP, RING) or through the RS-232 port.

12.2.1 Connection through TIP, RING terminals

When connected to the control panel telephone output, the GSM-4 module will simulate the telephone monitoring station, i.e. the control panel will dial the monitoring station telephone number stored in its memory and, if it coincides with the station number programmed in the module, the module will take over the connection and will send events to the monitoring station through GPRS (function: **Tel.event->SMS** will only enable monitoring through SMS). Having sent an event to the station, the module will confirm delivery of the event with a preset duration signal (function **Kissoff period**) and will wait for further events.

If there are any problems with the delivery of events through GPRS (e.g. a failure of the monitoring station Ethernet card), the control panel will receive no confirmation that the event has been sent. In such a situation it will "hang up" and consider the monitoring attempt unsuccessful. After a specified number of unsuccessful attempts (function **CA tries**), the module can send an SMS message (its contents is determined by function **SMS GPRS trbl.**) to the number **GPRStrbl.tel.nr**, informing about the problem, and make another attempt of the control panel monitoring through an alternative path:

- audio channel – with the **Pass as audio** option selected, the module will not simulate the monitoring station but will establish connection to the monitoring station number, using the industrial cellular telephone (functions **MS1 tel.number/MS2 tel.number**),
- as SMS – with the **Pass as SMS** option selected, each event will be sent as a separate SMS message to the mobile telephone number on the monitoring station side (functions: **MS1 SMS tel.nr/MS2 SMS tel.nr**). Format of the SMS message to be sent is defined by the **MS1 SMS format/MS2 SMS format** function.

12.2.2 Connection through RS-232 port

If the GSM-4 module is working with an INTEGRA series control panel, the communication can also be effected through the RS-232 port. In such a case, the **External modem** and **ISDN/GSM/ETHM modem** options must be enabled on the control panel side. When working in this configuration, the module only enables monitoring through GPRS, according to the transmission parameters programmed in the control panel (the module GPRS settings - Station IP address, Station port, Station key, GPRS key and System identifier – will be reprogrammed). The **Tst.INTEGRA cn.** option makes it possible to check the connection between the INTEGRA panel (in version 1.06 or later) and the module. If there is no connection, the module will send information to the monitoring station. With the **RS monit.prior.** option enabled, monitoring the INTEGRA control panel events will have priority over reporting the module status.

13. DLOAD10 PROGRAM

The GSM-4 module delivery set includes the DLOAD10 program, which enables the module to be programmed from a computer.

The program is designed for IBM PC/AT compatible computers. It works in any computer hardware configuration in the **WINDOWS** (9x/ME/2000/XP) environment. It is recommended that the program be installed on the computer hard drive.

The GSM-4 module communicates with the computer via the RS-232 interface. To connect the ports, use the cable made as shown on Fig. 8 (the cable symbol acc. to pricelist: DB9F/RJ-KPL).

The program installation consists in running the **setup.exe** program from a floppy disk delivered with the module. After installation, the program should be launched. Access to the program is protected with an **access code**. After installation of the program, the access code is: **1234** and can be changed in any string of 16 alphanumeric characters. As long as the code has its factory form, pressing the "ENTER" key (without entering any code) will start the program with the default access code (1234).

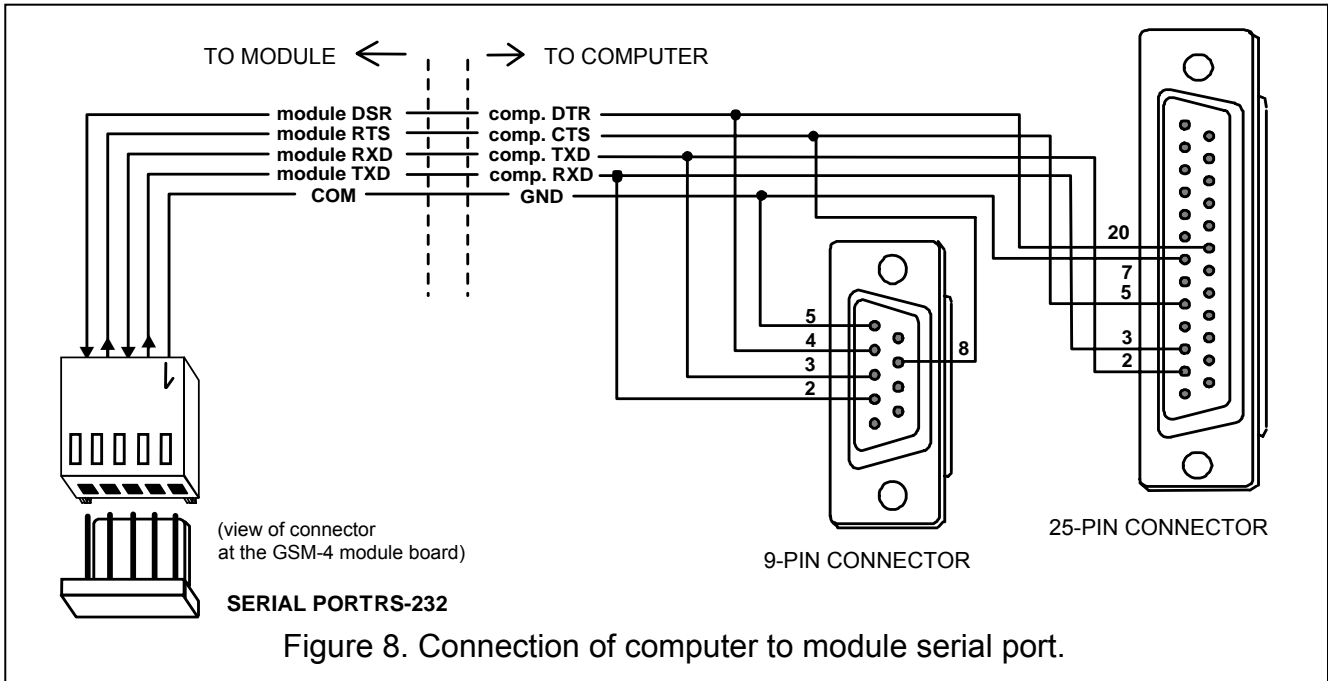

In order to establish communication between the DLOAD10 program and the module, you should follow the procedure below:

1. Connect the RS-232 ports of module and computer with an appropriate cable.
2. Open the window with module data by selecting **File→New device→GSM4/LT module** in the program menu (see figure 9).

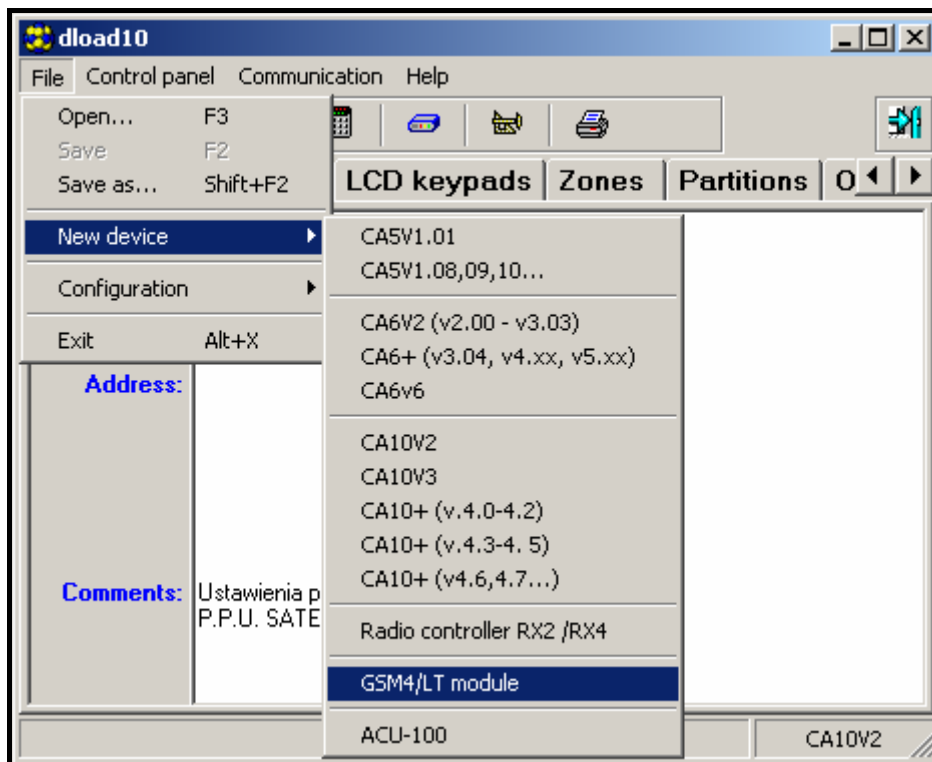



Figure 9.

3. Enter the option of module communication settings by clicking on the  icon (or through the **Communication** → **Configuration** menu) and select the port through which the computer connects with the module RS-232 port (see figure 10).

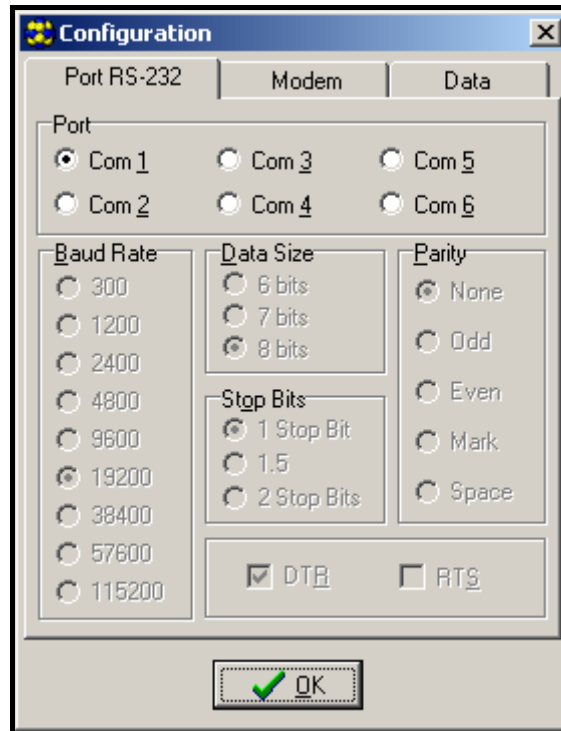



Figure 10.

4. Enter the DOWNLOADING password (preprogrammed in the module with **GSM-4 ident.** service function – see figure 11). By default, the password (AAAAAA) is not preprogrammed in the GSM-4 module.
5. Read out data from the module by clicking on the  icon. The communication establishing process is presented by an appropriated message on the GSM-4 task bar.
6. Program the module.
7. Save new data in the module by clicking on the  icon.
8. If necessary, you can save the programmed data as a file on the computer disk.
9. Disconnect the cable used for programming.

Note: Never carry out functional test of the module with cable connected to RS port.

13.1 “GSM-4” TAB

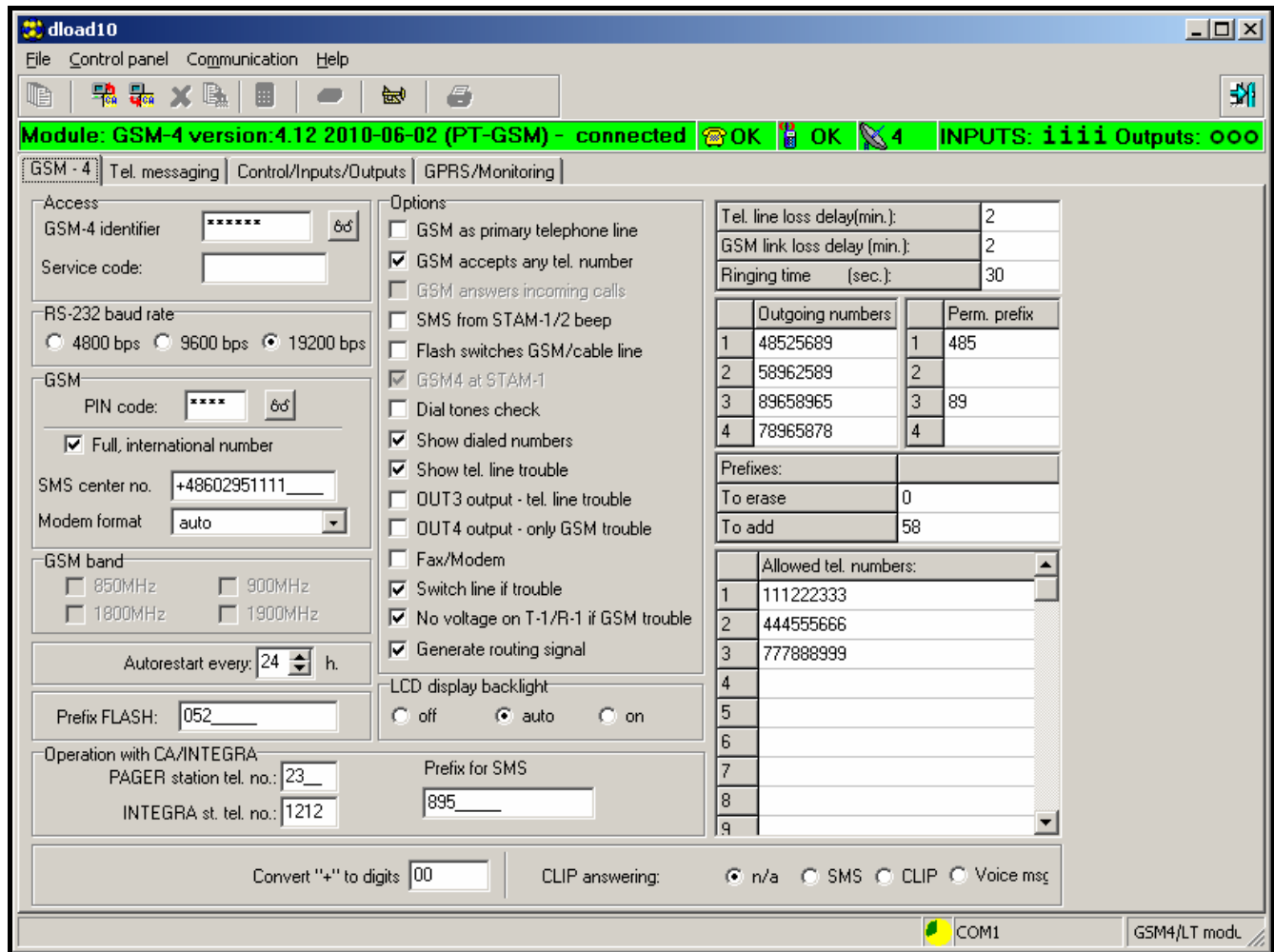

Figure 11.

This tab allows the user to configure the basic working parameters of the module. The parameters programmable in the GSM-4 tab correspond to the control functions and have been reviewed in section *Description of service functions*.

13.2 “TELEPHONE MESSAGING” TAB

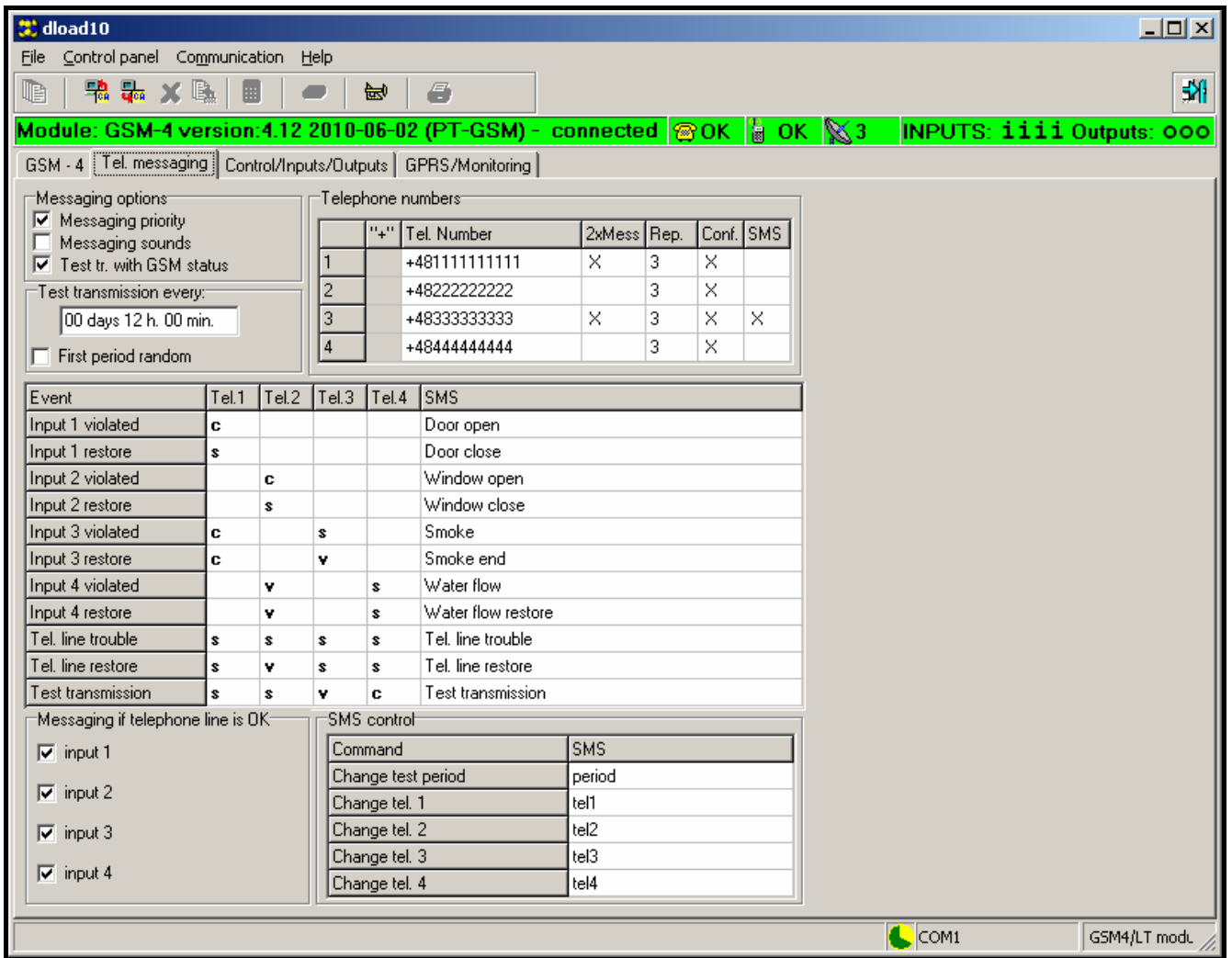

Figure 12.

The tab enables messaging parameters to be configured. The parameters programmable in the **Telephone messaging** tab correspond to the control functions and have been reviewed in section *Description of service functions*.

13.3 "CONTROL/INPUTS/OUTPUTS" TAB

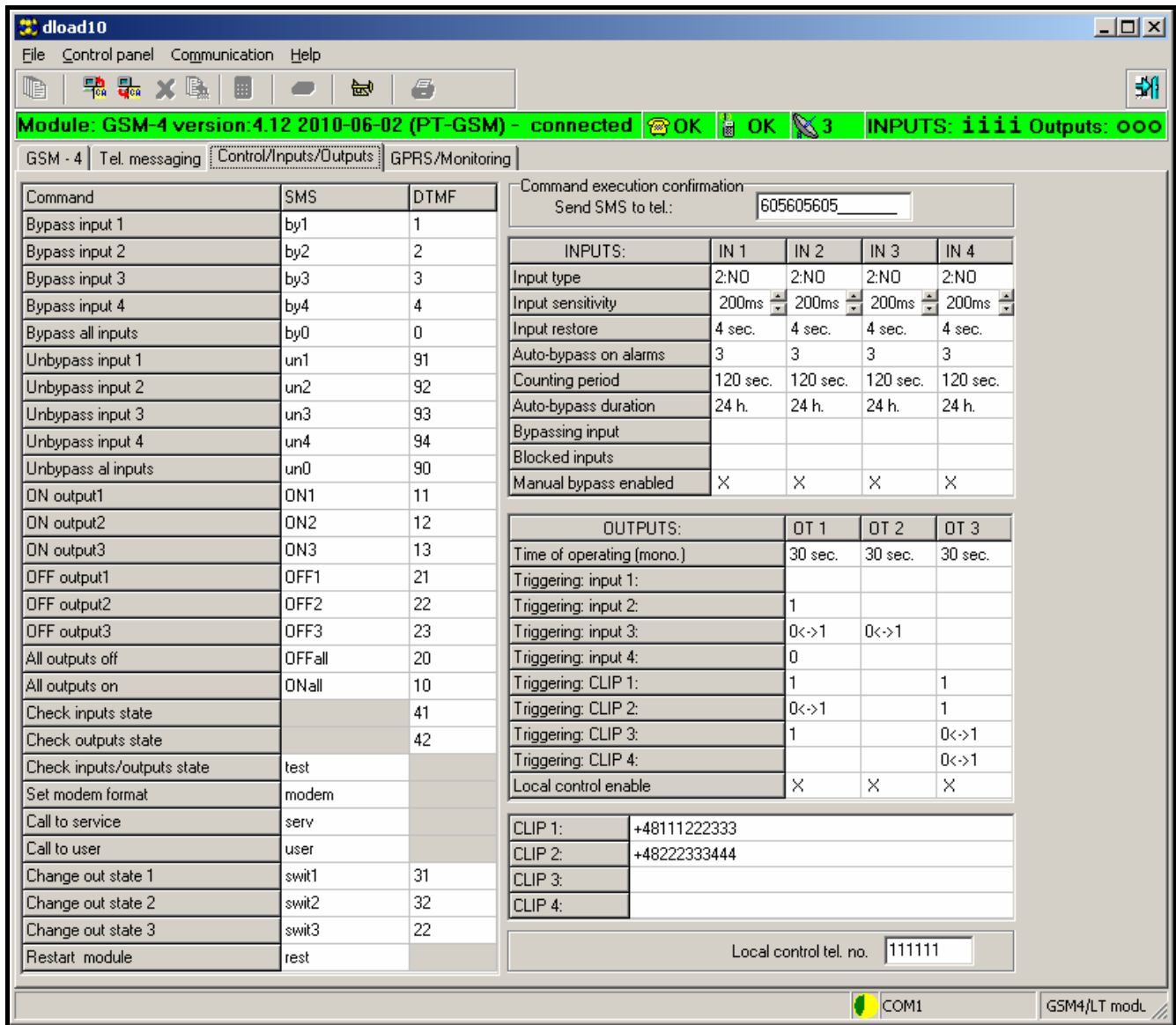

Figure 13.

The parameters programmable in the **Control/Inputs/Outputs** tab correspond to the control functions and have been reviewed in section *Description of service functions*.

13.4 "GPRS/MONITORING" TAB

Shown in Figure 14 is a view of the **GPRS/Monitoring** tab. The presented values are just example settings. By default, the GPRS transmission data are not programmed. All the options are discussed in detail in section *Description of service functions*.

Monitoring the module inputs requires that the format and codes of events be defined (**4/2** or **Contact ID**). For the CID format, the DLOAD program has a code generator (Figure 15), initialized by using the **...** button:

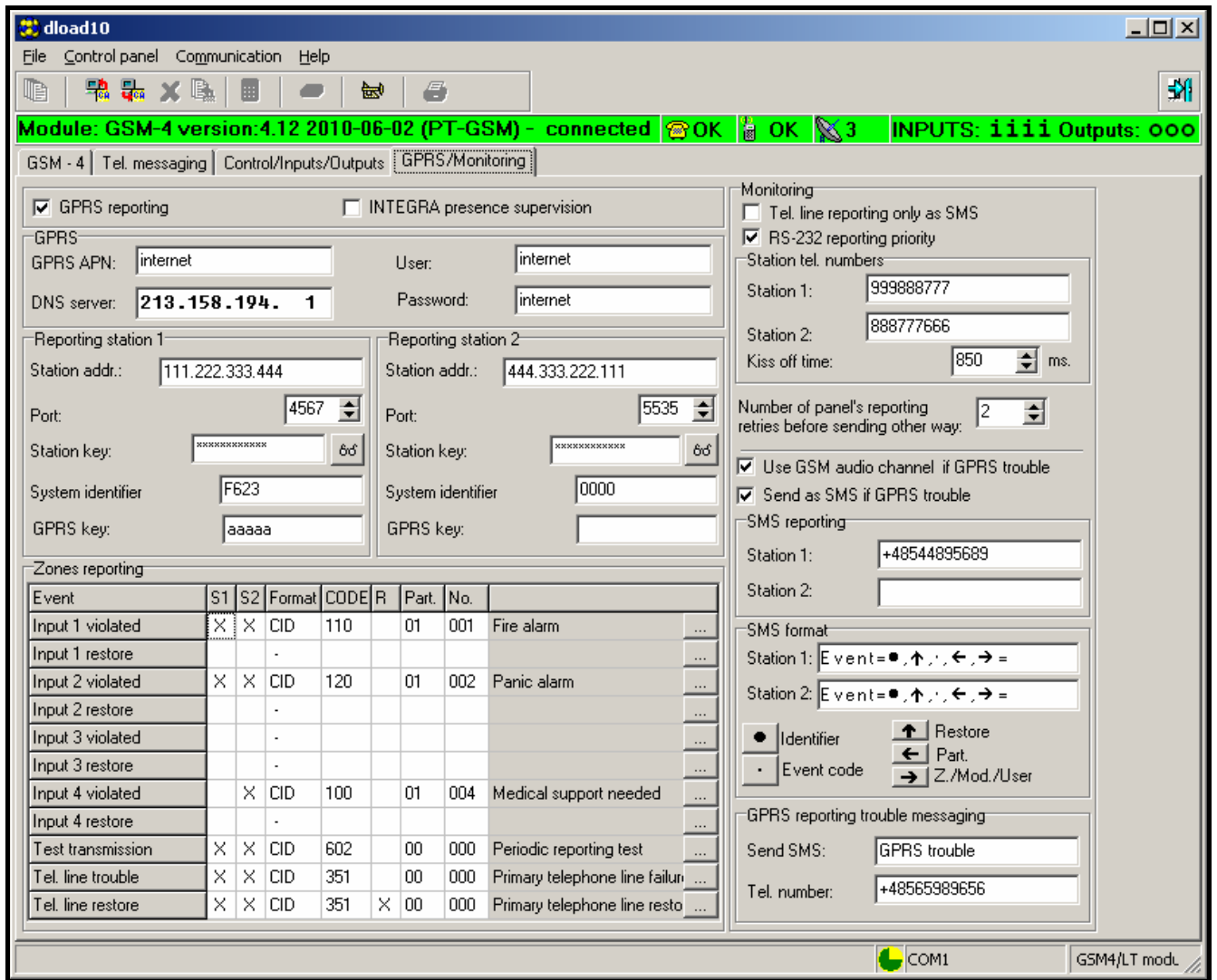

Figure 14.

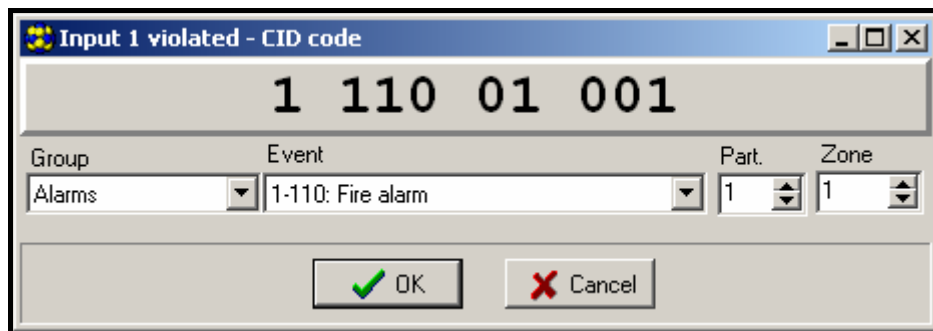

Figure 15. View of the generator of CID codes.

The generator enables CID code to be quickly defined for the following event:

- Group – type of the event,
- Event – code and description of the event,
- Partition – the partition number to be sent,
- Zone/Module/User – the number of zone /module/user to be sent.

A HELP system is provided which facilitates using the program and programming the module parameters. The system is available through the **HELP** menu or by pressing the **F1** key on the computer keyboard. For direct access to more detailed information, first select the

required element in the program window (by hovering over it with the mouse pointer and clicking the left mouse button), a then press the F1 key.

14. SERVICE MODE

The access to module's configuration is possible by entering the **service mode**. To enter this mode, simultaneously press and hold push-buttons **CHANGE** and **NEXT** approx. 1 second. While being in the service mode, the module makes the menu accessible (the menu is described below in this section). By using four push-buttons located on module's board, it is possible to go through the menu, select particular function and set the required parameters of these functions (options, numbers, passwords, time periods).

The access to the service mode can be protected by a code. The protection is activated by programming any code with the "Service code" function, and deactivated by deleting the code. The code consists of a combination of 1 to 8 digits from the range 0–9. The whole code can be erased in the process of its programming, when the **CHANGE** and **NEXT** keys are depressed at the same time.

When the code has been programmed, an attempt to enter the service mode will cause the module to display a suitable message and wait for entering the code. Unless the entered code is valid, the module will only enable the user to enter the service mode when all the settings are deleted. The "*Erase settings (123=yes):*" message is displayed – then, entering the digits 123 followed by pressing the OK key will initiate the test and erasing of the module memory (PCF), and then the service mode will be made available.

The push-buttons, while being used in the service mode, have the following meaning:

- ESC** – move within the menu to item **End of service**, return from submenu to the main menu, or exit from the function without saving the changes,
- CHANGE** – return to the previous function in menu or the change of selected element in the function (e. g. an option marker , a digit of a telephone number or a letter of a password),
- NEXT** – move to next function item within menu or move to next element of the function being programmed at present (e. g. successive digit of the telephone number or successive character of the password),
- OK** – entry into the function selected from menu (indicated by arrow on LCD display) for checking or changing the settings, exit from the function with saving the changes made.

The module in the service mode operates in the same way, as during normal mode i. e. it is possible to make and answer calls, but the status is not displayed. Instead of the status, the description of service functions are displayed, thus enabling the user to go through the menu of service mode and to make appropriate changes in the module's configuration. The features of manual controlling the outputs and manual bypassing the inputs are disabled. Holding any push-button will make that the pressing of that push-button is automatically repeated. When no push-button is pressed for the duration of approx. 1 minute, the module automatically exits the service mode.

Service mode menu:

- End of service
- Service code
- Line loss time
- GSM loss time
- Time of ringing
- Turn off TL volt
- Show T I.failure
- Show dialing.
- Signal testing
- CLIP -> number
- Any numbers
- Routing signal
- GSM main line
- Trbl. – switch I.
- FLASH – GSM/TL
- FLASH number
- Outgoing no 1
- Outgoing no 2
- Outgoing no 3
- Outgoing no 4
- Perm. prefix 1
- Perm. prefix 2
- Perm. prefix 3
- Perm. prefix 4
- Prefix to erase
- Prefix to add
- **Allowed numbers**
 - Tel. No 1 begin.
 - Tel. No 2 begin.
 - ...
 - Tel. No. 32 begin
- **Messaging**
 - Tel.1 for mess.
 - Tel.2 for mess.
 - Tel.3 for mess.
 - Tel.4 for mess.
 - Mess.x2 for t.1
 - Mess.x2 for t.2
 - Mess.x2 for t.3
 - Mess.x2 for t.4
 - Tries for tel.1
 - Tries for tel.2
 - Tries for tel.3
 - Tries for tel.4
 - Ack. CLIP tel.1
 - Ack. CLIP tel.2
 - Ack. CLIP tel.3
 - Ack. CLIP tel.4
 - SMS mess 1 fail
 - SMS mess 2 fail
 - SMS mess 3 fail

	<ul style="list-style-type: none"> — SMS mess 4 fail — SMS IN1 violat. — SMS IN2 violat. — SMS IN3 violat. — SMS IN4 violat. — SMS fail. line — SMS IN1 restor. — SMS IN2 restor. — SMS IN3 restor. — SMS IN4 restor. — SMS restor.line — SMS test — SMS tst.w.state — TL ok, mess.IN1 — TL ok, mess.IN2 — TL ok, mess.IN3 — TL ok, mess.IN4 — IN1 -> Tel. — IN2 -> Tel. — IN3 -> Tel. — IN4 -> Tel. — F.L. -> Tel. — Rest.1 -> Tel. — Rest.2 -> Tel. — Rest.3 -> Tel. — Rest.4 -> Tel. — Rest.L -> Tel. — Test -> Tel. — Test period — 1st test random — Mess. priority — Mess. sounds
SMS control	<ul style="list-style-type: none"> — SMS bypass IN1 — SMS bypass IN2 — SMS bypass IN3 — SMS bypass IN4 — SMS bypass all — SMS unbyps.IN1 — SMS unbyps.IN2 — SMS unbyps.IN3 — SMS unbyps.IN4 — SMS unbyps.all — SMS OT 1 on — SMS OT 2 on — SMS OT 3 on — SMS OT1 off — SMS OT2 off — SMS OT3 off — SMS chng. OT1 — SMS chng. OT2

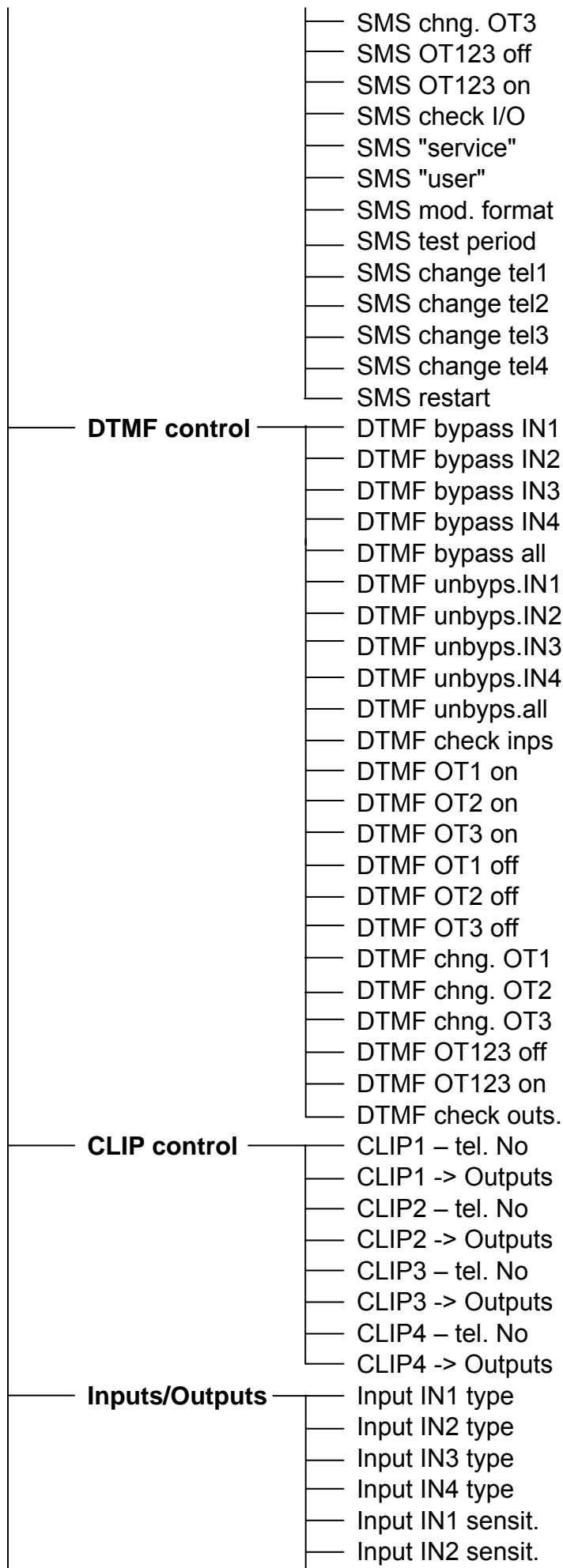

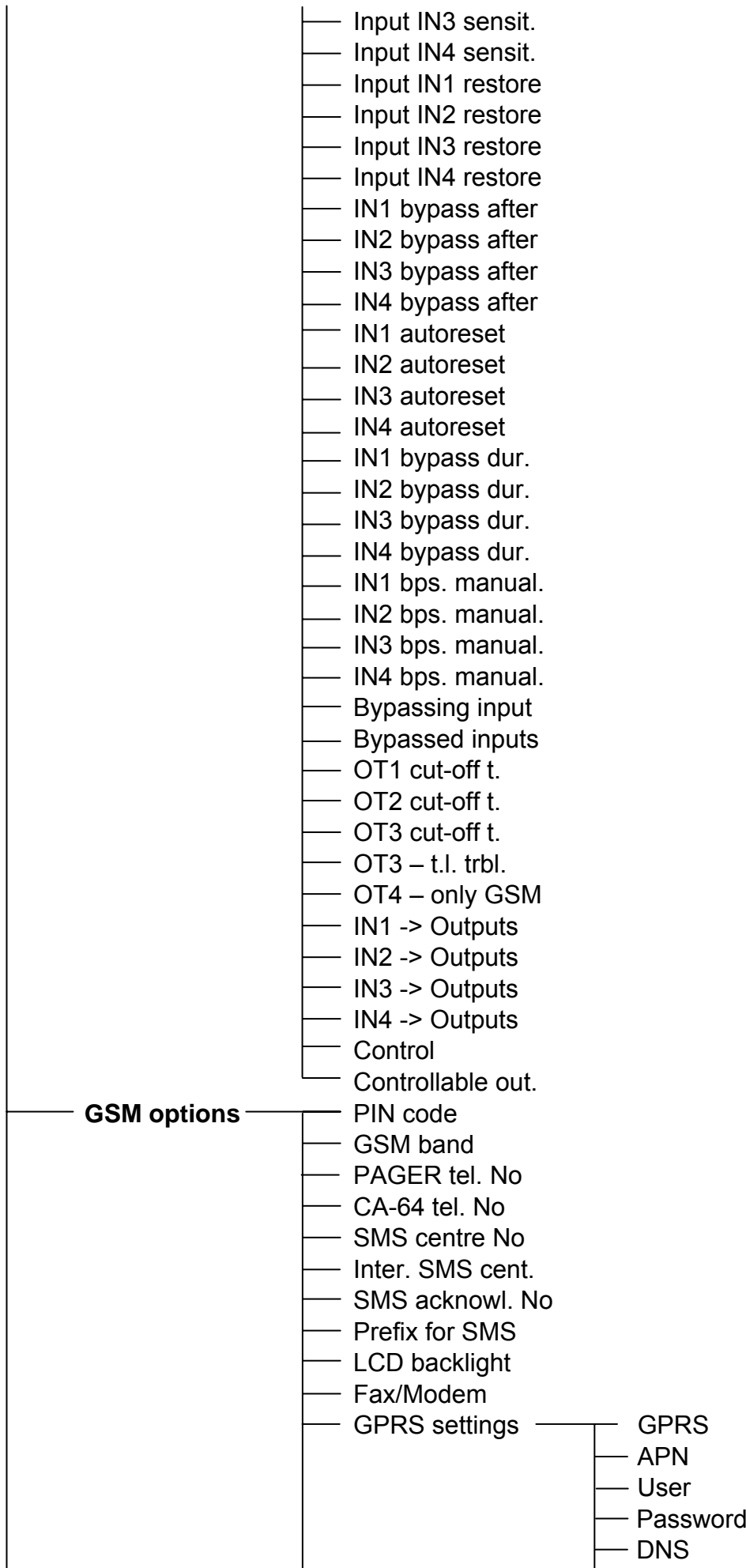

		<input type="checkbox"/> Tst.INTEGRA cn.
		<input type="checkbox"/> RS monit.prior.
		<input type="checkbox"/> MS1 address
		<input type="checkbox"/> MS1 port
		<input type="checkbox"/> MS1 key
		<input type="checkbox"/> GPRS 1 key
		<input type="checkbox"/> MS1 sys.ident.
		<input type="checkbox"/> MS2 address
		<input type="checkbox"/> MS2 port
		<input type="checkbox"/> MS2 key
		<input type="checkbox"/> GPRS 2 key
		<input type="checkbox"/> MS2 sys.ident.
		<input type="checkbox"/> MS1 tel.number
		<input type="checkbox"/> MS2 tel.number
		<input type="checkbox"/> Kissoff period
		<input type="checkbox"/> Tel.event->SMS
		<input type="checkbox"/> Pass as SMS
		<input type="checkbox"/> Pass as audio
		<input type="checkbox"/> MS1 SMS tel.nr
		<input type="checkbox"/> MS2 SMS tel.nr
		<input type="checkbox"/> MS1 SMS format
		<input type="checkbox"/> MS2 SMS format
		<input type="checkbox"/> CA tries
		<input type="checkbox"/> GPRStrbl.tel.nr
		<input type="checkbox"/> SMS GPRS trbl.
		<input type="checkbox"/> IN1 viol. code
		<input type="checkbox"/> IN2 viol. code
		<input type="checkbox"/> IN3 viol. code
		<input type="checkbox"/> IN4 viol. code
		<input type="checkbox"/> IN1 rest. code
		<input type="checkbox"/> IN2 rest. code
		<input type="checkbox"/> IN3 rest. code
		<input type="checkbox"/> IN4 rest. code
		<input type="checkbox"/> TL trouble code
		<input type="checkbox"/> TL restore code
		<input type="checkbox"/> Test trans.code
	<input type="checkbox"/> Autorestart	
	<input type="checkbox"/> Fax/Modem	
	<input type="checkbox"/> Modem format	
	<input type="checkbox"/> GSM-4 ident.	
	<input type="checkbox"/> Beep after SMS	
	<input type="checkbox"/> RS baud rate	
	<input type="checkbox"/> BTS test	
<input type="checkbox"/> Erase settings		

15. DESCRIPTION OF FUNCTIONS FOR PROGRAMMING THE MODULE

It is required for the functions for programming the module operation to set option, select items from the list, or possibly enter numeric or alphanumeric data (telephone numbers, SMS messages).

15.1 CHOICE OF OPTION

After the entry into the function (by pressing push-button OK) which requires choosing the option, pressing push-button **CHANGE** makes character **Y** display (option chosen). The repeated pressing the push-button CHANGE will erase this marker and switch off this option. Pressing the push-button **OK** will result in storing the present setting of option, and exiting from the function to the menu.

15.2 ENTERING NUMERIC OR ALPHANUMERIC DATA

After getting access to the function (by pressing push-button OK) which requires entering duration, telephone number, password or message, the blinking cursor is displayed on the module's display to show the field where the data can be entered. Each pressing the push-button **CHANGE** will result in changing the displayed digit or character. Digits are changing cyclically in the following order:

1→2→3→4→5→6 →7→8→9→0→#→*→+→ →1→2→3 and so on.

The content of the field for entering alphanumeric character is changing as follows:

A→a→B→b→C→c→D→d→E→e→F→f→G→g→H→h→I→i→J→j→K→k→L→l→M→m→N→n→O→o→P→p→Q→q→R→r→S→s→T→t→U→u→V→v→W→w→X→x→Y→y→Z→z→1→2→3→4→5→6 →7→8→9→0→.,+→-→*→/→:→;→=→!→@→#→\$→%→&→(→)→[→]→{→}→ →A→a→B→b and so on.

Pressing the push-button **NEXT** makes the cursor move to the next field to the right, or return to the first field on the left side of the number or password entered. Pressing the push-button **OK** results in storing the entered data and in exiting from the function.

15.3 DESCRIPTION OF THE SERVICE FUNCTIONS

End of service – completion of service mode and move to normal module operation.

Service code – combination of 1 do 8 digits from the range 0–9. Having programmed the code prevents access by the unauthorized users to the entered settings.

Line loss time – time that must elapse until the module will signal a trouble of the analog phone line by shorting the OT3 or OT4 output to ground (see functions: **OT3 – tel.l.trbl** and **OT4 – GSM only**). The time indicated here has no effect on how fast the line trouble will be found and the line replaced by the industrial cellular telephone – this will follow after approx. 16 seconds. Value from range 0–99 minutes, for 0 – no reaction.

GSM loss time – time that must elapse until the module will signal a trouble of the GSM telephone by shorting the OT4 output to ground (if the module fails to detect telephone presence for the time programmed here, SIM card is missing, there is no PIN code, antenna signal is zero, or the telephone is actually out of order). Value from range 0–99 minutes, for 0 – no reaction.

Time of ringing – time after which the connection to industrial cellular telephone number will be:

- rejected – if nobody answers the call from the extension line (T-1, R-1) and no control codes have been programmed,
- accepted – to make remote control possible, if there is any code to control inputs/outputs by using DTMF signals.

Range 0–99 seconds; for 0, no calls are answered or rejected by the module.

During the "*ringing time*", the module is sending the ring signal to terminals T-1, R-1 so that the call can be answered from a telephone connected to the extension line.

Turn off TL volt – turn off voltage on the telephone line terminals in the event of GSM failure (e.g. insufficient range, defective antenna).

Show T l.failure – the option activates the function of displaying a message about telephone line failure. It is used when the subscriber's line is permanently connected to the module.

Show dial. num. – the option which decides about displaying a telephone number when a call is made via the module (e.g. when the control panel is reporting an alarm).

Signal testing – selecting this option results in checking the tone in telephone line, after "pick-up". If no continuous tone is detected after approx. 2 seconds, the module will replace the cable line with GSM telephone and call the line trouble.

CLIP -> number – select the character, letter or digit to which the "+" character of the calling party number is to be converted during the CLIP control.

Any numbers – setting this option permits making outgoing calls from extension telephone, via the GSM-4 module, to any numbers (considering "outgoing line numbers", permanent prefixes, prefixes to be added and prefixes to be erased). If this function is disabled, it will be possible to call, via GSM telephone, only those telephone numbers, which the first digits (or complete numbers) are loaded into the module's memory by the function **Tel. No 1 begin.** ÷ **Tel. No. 32 begin.**

Routing signal – generation of the routing signal (audible signaling during connection set-up).

GSM main line – checking this option results in selecting the wireless industrial cellular telephone as the basic line to make connections (initiated from the T-1, R-1 terminals). If this option is unchecked, the cable line is the basic one.

Trbl. – switch l. – if this option is selected, the module will automatically switch over to the other line (cable / GSM) in the event of the basic line failure (GSM / cable).

FLASH – GSM/TL – this option activates the function of choosing the connection route (cable network/wireless GSM network) when making a call from a telephone connected to the T-1, R-1 terminals. If this option is selected and after picking up the receiver we press the FLASH key, then GSM-4 module switches from basic telephone line to alternative. Which line is the basic one (cable network or wireless GSM network) is determined with **GSM main line** function. If only one of lines be available, the module will choose it automatically without possibility of switching.

FLASH number – a string of 1 to 4 optional digits defined as a prefix for switching over from the alternative telephone line to the basic one. The module will only switch over to the corresponding line after it recognizes them.

Outgoing No. 1–4 – for these functions it is necessary to enter the telephone numbers, which will be treated as the numbers for getting subscriber's line (Public Exchange Telephone Line), in case that the module is not directly connected to subscriber line, but indirectly via private exchange (PBX) – see **The rules for converting the numbers.**

Perm. prefix 1–4 – initial digits of telephone numbers, that will not be corrected by calling with GSM telephone. It may be for example: codes for GSM network and numbers with area codes.

Prefix to erase – initial digits of telephone numbers, that will be deleted before sending a number to GSM telephone. For example, prefix to erase can have the value: "0" - standard outgoing number for a long-distance call.

Prefix to add – digits, that will be added at the beginning of telephone number before sending to GSM telephone. The prefix to be added is the area code, which is used in the

location where the GSM-4 module is installed. The local telephone number, before sending to GSM telephone, will be automatically complemented with the area code.

Allowed numbers – the move to submenu for programming the telephone numbers accepted by the module.

Tel. No. 1–32 beginning – for these functions it is required to enter the first digits (any number of digits), or complete telephone numbers, to which the calls can be made via industrial cellular telephone – if the "Any number" option is not set. When the **Any numbers** option is set, the above mentioned telephone numbers are of no importance. The numbers to be entered must have the same form as the numbers dialed by the GSM telephone i.e. must contain area code, for instance: "602 123456", "58 5551122". If the initial digits are programmed, the dialed number must contain all these programmed digits at the beginning.

Note: *The list of telephones 1–32 and the **Any numbers** option do not affect the selection of addressee of SMS messages.*

Messaging – submenu of functions for programming the data and options for messaging.

Tel. 1–4 for mess. – telephone numbers to which messaging on violation and restoration of inputs, or activation and switch OFF of output OT4 will be sent. The telephone number programmed by this function must have a complete form including country and area codes or cellular network code.

Mess. x2 for T. 1–4 – setting this option for a given telephone number will result in making a call twice to a dialed number and replaying the voice message each time – while executing the voice messaging.

Tries for tel. 1–4 – number of attempts to send CLIP to telephone nos. 1–4. It is possible to program from 1 to 15 attempts.

Ack. CLIP tel. 1–4 – with this option selected, the module will require that the user acknowledge receiving the CLIP sent to telephone nos. 1–4.

SMS mess 1–4 fail – if you select this option, an SMS message will be sent to the telephone number, if the module, having completed all the attempts, receives no acknowledgement of the CLIP reception from the selected telephone.

SMS violat. In.1–4 – contents of SMS message to be sent to cellular telephone number after violation of a given input (indication on LCD display $i \rightarrow I$). It is possible to choose a standard contents or to enter your own message. (up to 32 characters).

SMS fail. line – contents of SMS message to be sent to cellular telephone number after activating the output OT4. You can select standard contents (phone line failure) or enter your own message (up to 32 characters).

SMS restor. In.1–4 – contents of SMS message to be sent to cellular telephone number after the input is restored to normal state ($I \rightarrow i$).

SMS restor. line – contents of SMS message to be sent to cellular telephone number after restoration of input OT4 to normal state (telephone line available and operative).

SMS test – contents of SMS message to be sent to cellular telephone number in a test message.

SMS tst. w.state – enabling this option will result in information on the current status of the module outputs/inputs and the telephone line being attached to the SMS contents for test transmission.

TL ok, mess.IN1–4 – if this option is disabled for the particular zone, messages from this zone are sent only in case of the cable telephone line failure.

In. 1–4 -> Tel. and F. L. -> Tel. – programming the options for messaging. These options are used for selecting telephone numbers, to which the messages shall be sent after

violating the input or after failure of telephone line, and for choosing the type of messaging (SMS/CLIP/VOICE). The option is set by pressing push-button CHANGE.

The successive pressing makes the character display at the telephone numbers:

s – SMS,

c – CLIP,

v – voice message

(no display) given number is omitted while violating a given input.

Rest. 1–4 -> Tel. and **Rest. L -> Tel** – these functions are utilized for programming the second set of the messaging options. They are used for selecting telephone numbers to which the messages shall be sent after restoration of inputs to normal state or restoration of telephone line, and for choosing the type of messaging (SMS/CLIP/VOICE). The way of programming is the same as the violation of inputs.

Test ->Tel. – messaging options for test messages. You can indicate here to which telephone numbers what types of messages (s, c, v) will be sent during the test messaging. The test message period is programmed with the **Test period** function. The programming procedure is identical as for the input violation.

CLIP -> Tel. – type of answer (SMS/CLIP/AUDIO) to the user's CLIP to confirm availability of the device. The programming procedure is identical as for violation of inputs.

Note: *The telephone to which the GSM-4 module is to call back (CLIP and voice message) must be on the list of **permitted numbers**.*

Test period – test transmission period. It is possible to program up to **31 days 23 hours 59 minutes**. Entering the value 00 will reset the test transmission. The test transmissions are done independently of other connections related to messaging.

1st test random – the first period of test transmission done within a time randomly selected by the module. The next transmissions will take place according to the period preprogrammed using the **Test period** function.

Mess. priority – setting this option assigns the priority for messaging. In case of making a call, when the condition for tripping the messaging occurs, the call will be interrupted and the module will transmit the messaging. When this option is not set, the messaging shall be sent after the user hangs-up.

Mess. sounds – setting this option for voice messaging makes the module generate sounds, informing which inputs have been violated (see: **Messaging**).

SMS control – submenu of functions for programming the SMS passwords (6 alphanumeric characters) utilized for remote control by SMS messages.

SMS bypass In. 1–4 – passwords, which allow the system to bypass individual input.

SMS bypass all – password allowing the system to bypass all inputs simultaneously.

SMS unbyps. In 1–4 – passwords permitting the system to unbypass individual input.

SMS unbypass all – password permitting the system to unbypass all inputs simultaneously.

SMS OT1–3 on – passwords to enable particular outputs OT1–OT3. The outputs for which the cut-off time has been programmed will remain enabled for the specified time.

SMS chng. OT1–3 – SMS codes changing individual outputs OT1–OT3.

SMS off OT123 – password, which allows the system to switch OFF all outputs simultaneously.

SMS on OT123 – password permitting the system to switch ON all outputs simultaneously.

SMS check I/O – password allowing the system to check the state of all inputs and outputs. After receiving this password, the module sends the text message on the present state of outputs and inputs, telephone line status, transmission period and

telephone numbers to be notified – to the telephone number programmed by the function **SMS acknowl. No.**

SMS "service" – password which allows to start remote communication between the INTEGRA alarm panel and DLOADX program or CA-64 alarm panel and the DLOAD64 program (it applies to the CA-64 alarm control panel version 1.04.03 or later, and the DLOAD64 program version 1.04.04 or later). In order to start remote communication with the DLOADX/DLOAD64 program, send to the module the following SMS message: "**password=yyyy.**", where the "yyyy" means the telephone number to be called back by the control panel. Put a dot after the telephone number. If the sent message contains no telephone number, the panel will connect to the number preprogrammed in its memory. If the module has received the SMS message initiating connection with the INTEGRA control panel, and the access from DLOADX program is blocked, the module will send an SMS message informing that the "Remote access to DLOADX program is blocked" to the number predefined using the **SMS acknowl. No** function.

SMS "user" – password which allows to start remote communication between the INTEGRA alarm panel and GUARDX program or CA-64 alarm panel and the GUARD64 program (it applies to the CA-64 alarm control panel version 1.04.03 or later, and the GUARD64 program version 1.04.04 or later). In order to start remote communication with the GUARD64 program, send to the module the following SMS message: "**password=yyyy.**", where the "yyyy" means the telephone number to be called back by the control panel. Put a dot after the telephone number. If the sent message contains no telephone number, the panel will connect to the number preprogrammed in its memory.

SMS mod. format – password which allows to change the preprogrammed modem format. The preprogrammed modem format will be changed after sending a "**password=format code**" SMS. Two-digit codes assigned to corresponding formats are shown in the table at the description of the **Modem format** service function.

SMS test period – a password which enables remote change of the test transmission period. Sending to the module an SMS message containing the "**password=P**" string, where "P" is the parameter defining the test transmission period as described below:

0 – no test transmission,

1 – transmission period equal to 2 h 58 min,

2 – transmission period equal to 5 h 57 min,

3 – transmission period equal to 11 h56 min,

4 – transmission period equal to 23 h55 min,

5 – transmission period equal to 2 d 23 h53 min,

6 – transmission period equal to 6 d 23 h30 min.

SMS change tel1–4 – password which enables remote change of the telephone number to be notified. Sending to the module an SMS message containing the "**password=nnnn.**" string (password, equality sign, telephone number, dot), where **nnnn** is the new **telephone number for test transmission**, will change the parameter programmed with the function *Tel. no. for mess. 1–4*.

SMS restart – SMS code to restart the module.

DTMF control – submenu of functions for programming the DTMF codes (4 digits) to be used for remote control by dual tone phone keypad.

DTMF bypass In. 1–4 – DTMF codes permitting the system to bypass an individual input.

DTMF bypass all – DTMF code, which permits the system to bypass all inputs simultaneously.

DTMF unbyyps. In. 1–4 – DTMF codes enabling the system to unbyypass separate input.

DTMF unbypas. all – DTMF code permitting the system to unbypass all inputs simultaneously.

DTMF check inps – DTMF code permitting the system to check the status of module's inputs (bypassed/unbypassed). The way of signaling is described in section **Description of outputs and input** of this operating manual. After completing each command for bypassing/unbypassing, the module automatically executes this function.

DTMF OT1–3 on – DTMF code for enabling a single output. If a cut-off time has been programmed for the particular output, the output will be enabled for the specified time.

DTMF OT1–3 off – DTMF code for disabling a single output.

DTMF chng. OT1–3 – DTMF code, changing the individual output status to the opposite one.

DTMF off OT123 – DTMF code permitting the system to switch OFF all outputs simultaneously.

DTMF on OT123 – DTMF code allowing the system to switch ON all outputs simultaneously.

DTMF check outs – DTMF code allowing the system to check the state of all outputs. The way of signaling is described in section **Remote controlling by dtmf signals from touch - tone telephone keypad**.

CLIP control – opens the submenu of functions controlling the module outputs with the use of CLIP function. You can program four telephone numbers and the output operating mode suitable for the given telephone number.

CLIP1–4 tel. No – telephone numbers from which the control will be realized. The telephone number programmed with this function must be identical with that displayed during presentation of the caller ID in a cellular phone (e.g.: 502345678; 601555999). For a stationary network you should program the area code prefix followed by the actual phone number (e.g.: Gdańsk – 581111222; Warsaw – 225555666; etc.).

CLIP1–4 →Outputs – type of output control to be triggered with the CLIP signal. The programming consists in determination of the control separately for each of the module outputs (0 – disable output, 1 – enable output, x – change output, · – no reaction). Each of the CLIP numbers can perform control of a different kind. See: **Settings List**.

Inputs/Outputs – submenu of functions for programming the parameters of module's inputs and outputs.

Input 1–4 type – type of sensor connected to the input. Selection of a sensor (1 – NO; 2 – NC) is done by push-button CHANGE.

Input 1–4 sensit. – the sensitivity of each input. The following values (in msec) can be programmed: 20, 40, 60, 80, 100, 130, 160, 200, 250, 300, 400, 500, 600, 800, 1000, 1275.

Input 1–4 restore – time from the end of violation, after which the inputs shall be again supervised. The possible settings are 4 seconds or 4 minutes. The status of input is indicated as "violated" (I) until the restoration time expires.

Inp. 1–4 bypass # 1 – automatic bypassing of input after 1 preprogrammed number of violations (0–15, for 0 – no bypassing).

IN1–4 autoreset – time, after expiry of which the violation counters will be reset (0–127 seconds or minutes, 0 – counting violations with no time limits).

IN1–4 bypass dur. – time during which the input is bypassed (0–127 minutes or hours, 0 – permanently bypassed, until user intervention).

Inp.1–4 man.byp. – selecting this option will make manual bypassing/unbypassing of inputs available (by means of module buttons): **Y** – yes, **N** – no. After pressing three times the suitable key under the LCD display bypassing/unbypassing will occur.

This function also prevents bypassing the inputs from terminals T-1, R-1 (unbypassing will still be possible).

Bypassing input – input's number, violation of which will result in bypassing the remaining module inputs. This operation is bistable – the inputs bypassed will remain in such a status until the end of input violation (I → i) set by this function. This function is disabled by selecting (during programming) the option designated as "No number".

OT1–3 cut-off t. – output cutoff time (0–255 seconds or minutes, for 0 – permanently bypassed, until user intervention).

OT3 – tel.l.trbl. – with this option selected, the OT3 output will play the role of the analog telephone line indicator of (TIP, RING).

OT4 – GSM only – when this option is set, the OT4 output is activated only on the failure of GSM telephone. If this option is not set, the OT4 output is activated on GSM telephone failure and on the failure of cable telephone line (TIP, RING) as well.

In. 1–4 -> Outputs – the way of controlling the outputs to be tripped by the violation of input. Programming consists in choosing the type of control individually for each module's output. (see: **Settings List**).

Control – a six-digit code enabling manual (local) control of the module inputs and outputs (through DTMF) from a telephone set connected to the extension line (T-1, R-1).

The control function is available after dialing the code that has been programmed here (to confirm its readiness for control, the module will generate beeps: 4 short and 1 long). Then enter control sequences, consisting of the "*" character and 2 digits: the first digit defines the command, the other one – the input/output number ("0" meaning that the selected command is to apply to all inputs/outputs). Execution of the selected control sequence will be acknowledged by three short beeps (or two long beeps in case of an error). Entering the "*" character will each time begin a new control sequence. Available commands:

- 1 – bypass input,
- 2 – unby pass input,
- 3 – check input status (in response, the device will generate beeps):
 - 1 short beep – input unbypassed,
 - 3 long beeps – input bypassed.
- 4 – enable output(s),
- 5 – disable output(s),
- 6 – check output status (in response, the device will generate beeps):
 - 1 short beep – output disabled,
 - 2 short beeps – output enabled.

Controllable out. – selection of outputs which can be locally enabled/disabled from terminals T-1, R-1. This option does not affect the capability of enabling/disabling the outputs by means of the module buttons.

GSM options – submenu of functions for programming the data required for the operation of industrial cellular telephone.

PIN code – PIN code of the SIM card inserted in the cellular telephone. The code is entered in the module's memory once. It is possible to read out the loaded PIN code after calling this function. If necessary, the code is transmitted from the GSM-4 module to the telephone. Entering the wrong PIN code can result in blocking SIM card. In case of such situation, the message is displayed on the module's display with a request for

entering the PUK code. Entering the PUK code should be performed by using normal cellular telephone (after replacing the SIM card).

GSM band – the frequency range in which the module built-in phone can work. There are the following bands to choose from:

- 850 MHz,
- 900 MHz,
- 1800 MHz,
- 1900 MHz.

You can select any combination of bands. If all or none of them are selected, the module will recognize that all frequencies are available and will choose the most suitable one(s).

***Note:** The option is only available for some telephone models.*

PAGER tel. No. – 4 digits or a sequence of 1 to 4 digits (depending on the module firmware version) which activate the function for sending the message in a form of SMS text message. Detecting these digits at the beginning of the dialed number will result in classifying the remaining part of the number as the cellular telephone number, to which the message from the alarm control panel (in a form of a message to pager system) is to be transmitted.

CA-64 tel. No. – 4 digits of the telephone number, which enable the module to recognize the text message sent by the alarm control panel CA-64.

***Note:** The change of the number "pager station" and "alarm control panel CA-64" is up-dated in the module's memory after the exit from the service mode.*

SMS centre No. – the SMS centre number, which is required in order to send the text messages. The entered number depends on GSM network in which the telephone is activated and must be preceded by the country code suitable for the operated network.

Inter. SMS cent. – the option indicates whether the programmed number of SMS centre is a full international number.

SMS acknowl. No. – mobile telephone number to which the GSM-4 module will send the SMS message, confirming execution of the control (through SMS) and containing the current state of inputs and outputs. The number must be programmed in its full form, including the country code (for Poland: 48), in much the same way as the above SMS centre numbers.

Prefix for SMS – it is programmed if the cellular telephone numbers, taken from the alarm control panel while capturing the pager messages, do not possess such a prefix. Programming the prefix enables the module to send SMS messages to the cellular telephone number.

LCD backlight – setting the mode of display (available for the modules with backlit display). The following setting are possible:

- none,
- auto,
- permanent.

GPRS settings – configuration of GPRS transmission parameters

GPRS – enable GPRS transmission: – yes, – no,

APN – name of access point for Internet GPRS connection,

User – user name for Internet GPRS connection,

Password – code for Internet GPRS connection,

DNS – DNS server IP address to be used by the module. The DNS server IP address is necessary if the data are transmitted using GPRS technology, while the IP address of the monitoring station is entered in name form. If all the IP addresses are entered in numerical form (4 decimal numbers separated by dots), the DNS server address need not be programmed.

Tst.INTEGRA cn. – test the status of connection to INTEGRA control panel through RS-232 port: – yes, – no.

RS monit. prior. – priority of monitoring from the RS-232 port. With this option selected, monitoring the events of INTEGRA control panel connected to the module via the RS-232 port will have priority over reporting the state of GSM-4 module: – yes, – no.

Note: If the module is connected to the control panel telephone outputs, the transmission of events will always have priority over reporting the state of the module.

MS1 address/MS2 address – IP address of the monitoring station. It can be entered in the form of a name or in the form of a number.

MS1 port/MS2 port – number of the TCP port through which communication with the monitoring station will be effected. Values from 1 to 65535 can be entered. The port number must correspond to that defined in the monitoring station.

MS1 key/MS2 key – a sequence of 1 to 12 alphanumeric characters (digits, letters and special characters) which define the key for coding the data to be sent to the monitoring station. It must correspond to that defined in the monitoring station

GPRS 1 key/GPRS 2 key – a sequence of 1 to 5 alphanumeric characters to identify the GSM/GPRS module. It must correspond to that defined in the monitoring station ("ETHM/GPRS key").

MS1 sys.ident./MS2 sys.ident. – a sequence of 4 characters (digits or letters from A to F) to identify the module. Using the digit 0 in the identifier is not recommended. Default value: 0000 (this sequence means that there is no identifier).

MS1 tel.number/MS2 tel.number – the telephone number defined in the control panel for the given monitoring station. The module will simulate receiving the event codes by that station. If the parameter is not programmed or is inconsistent with that programmed in the control panel, the module will be unable to receive the event codes sent by the control panel.

Kissoff period – duration of the signal generated by the module to confirm receiving the event from the control panel. The entered value must be suitable for the control panel settings (selected monitoring format). Values from the 100 to 2550 ms range can be programmed (by default: 850 ms). Factory setting: 850 ms.

Tel.event.->SMS – monitoring events from the telephone line as SMS only. With this option selected, the events will only be sent from the control panel to the monitoring station as SMS messages (with no attempt to send them through GPRS): – yes, – no.

Pass as SMS – alternative transmission of the events through SMS: – yes, – no.

Pass as audio – alternative transmission of the events through audio channel: – yes, – no.

*Note: Settings of the options **List of permitted numbers** and **Any numbers** have no effect on the monitoring station telephone number to which the event is to be sent through the audio channel.*

MS1 SMS tel.nr/MS2 SMS tel.nr – numbers of the monitoring station mobile telephones to which SMS messaging will be effected (up to 16 digits, preceded by "+" character).

MS1 SMS format/MS2 SMS format – the SMS message format for SMS monitoring. It must be defined as required by the monitoring station. The SMS message format which is programmed by default corresponds to the default settings of the STAM-2 monitoring station (program version 1.2.0 or newer). The symbols used when programming the SMS format have the following meaning:

- - identifier;
- ↑ - beginning/end;
- - event code;
- ← - partition;
- - zone/module/user.

For the 4/2 formats, only the identifier and event code will be sent. Question marks will be sent instead of any other information.

CA tries – number of control panel attempts before sending event through alternative path. The parameter defines the number of failed attempts to send events through GPRS, after which the control panel will make an attempt to send them through an alternative path (2–255, by default: 3):

- audio channel – if the **Pass as audio** option is selected.
- as SMS – if the **Pass as SMS** option is selected.

GPRStrbl.tel.nr – mobile telephone number to which SMS message (its contents programmed with the **SMS GPRS trbl.**) will be sent if communication through GPRS is lost.

SMS GPRS trbl. – body of SMS message to be sent in case of problems with GPRS transmission (up to 32 characters, by default: GPRS monitoring trouble).

Note: *The SMS will only be sent if the module is connected to the control panel telephone outputs (the function is inactive for connection through the RS port).*

IN1–4 viol. code – code of violation of the inputs 1–4; in **ab,c,ddd,e,ff,ggg** forms, where:

- ab** – send event to monitoring station: a – Station 1, b – Station 2 (Y – yes, · – no),
- c** – event format (C – Contact ID, N – format 4/2, · – none),
- ddd** – event code,
- e** – input violation/restore (· – violation, r – restore),
- ff** – partition number,
- ggg** – zone/module number.

Example: CID code of the "AC loss" event to be sent to two monitoring stations from zone 5 of the second partition is: **YY C 301 · 02 005.**

IN1–4 rest. code – code of end of violation of the inputs 1–4. Settings as for the violation code.

TL trouble code – code of the telephone line trouble. Settings as for the violation code.

TL restore code – code of the telephone line restore. Settings as for the violation code.

Test trans.code – test transmission code. Settings as for the violation code.

Autorestart – the function enables programming the time (from the 1 hour to 25 hours) after which the module, if not used, will restart the phone. To use the module means to:

- answer a call when calling from the module,
- receive the ring signal in the module,

- confirm sending SMS message from the module,
- receive SMS message,
- use the module as external modem.

The first restart of the phone will take place after the preprogrammed time from the settings being written to the module has elapsed.

Fax/modem – with this option selected you can use the module as a fax/modem. The RS connector makes it possible to use all the modem and fax features of the industrial cellular telephone. The module starts working as a modem after it receives the AT signal through the RS port, and stops the operation when the computer DTR signal disappears.

Modem format – setting parameters of the modem the GSM-4 module communicates to. The table below shows all the available modem formats and the codes assigned to them, which are necessary to change the pre-programmed modem for another one by means of an SMS message:

format code	modem format
00	auto
01	300 V.21
02	1200 V.22
03	1200/75 V.23
04	2400 V.22bis
05	2400 V.26ter
06	4800 V.32
07	9600 V.32
12	9600 V.34
14	14400 V.34
65	300 V.110
66	1200 V.110/X.31
68	2400 V.110/X.31
70	4800 V.110/X.31
71	9600 V.110/X.31
75	14400 V.110/X.31

GSM-4 ident. – a code which allows starting of the module communication via the RS-232 port with the DLOAD10 program (version 1.04.15 or later) and with the STAM-1 and STAM-2 monitoring station program.

Beep after SMS – if this option is enabled when the module is used in conjunction with the STAM-1 / STAM-2 monitoring station, a sound signal will be generated to confirm sending each SMS message with the module from the STAM-1 / STAM-2 monitoring station.

RS baud rate – setting the data transfer rate via the RS-232 port. The following options are available:

- 4800 bps,
- 9600 bps,
- 19200 bps.

BTS test – starting the function will display on the LCD screen the following GSM network related information:

ARFCN, RXL, RXQ, MCC, MNC
 BSIC, CELLID, RLA, TXP,
 where:

ARFCN (absolute radio frequency channel number) – radio channel number

- RXL (receive level) – received signal level
- RXQ (receive quality) – received signal quality
- MCC (Mobile Country Code) – country code
- MNC (Mobile Network Code) – operator code
- BSIC (Base Station Identity Code) – base station code
- CELLID (Cell Identity) – cell identifier
- RLA (receive level acces minimum)
- TXP (transmit power maximum CCCH)

Erase settings – erasing all telephone numbers and prefixes and restoring default settings for options and times. All outputs are switched OFF and all inputs are unbypassed. Before canceling, the module requests for confirmation of such command.

Notes:

- *Each telephone number can consist of maximum 16 digits, and prefix can have maximum 8 digits.*
- *Erasing the telephone number is possible by erasing the last digit (push-button **CHANGE** and **NEXT** should be used), until the complete number is cancelled. The whole telephone number can be also erased by holding both push-buttons **CHANGE** and **NEXT** simultaneously.*
- *The outgoing line numbers 1–4, permanent prefixes 1–4 and telephone numbers 1–32 do not require that they must be entered consecutively, for example two outgoing line numbers can be entered in any two of four available fields **Outgoing No. 1–4**, not necessarily in two first fields.*

The changes entered in the service functions have in majority immediate results, i. e. immediately after the exit from the function by pressing push-button "OK".

16. EXAMPLES OF PROGRAMMING THE NUMBERS AND PREFIXES

Example 1:

- the module is directly connected to a subscriber line in Gdansk (area code for Gdansk - 58)
- outgoing calls via the module are to be allowed only to the following telephone numbers:
 - 111-00-11 – Security Dept.
 - 222-00-22 – Administration Dept.
 - 333-00-33 – residence telephone number of the owner
 - 0-602 440-440 – cellular telephone number of the owner
 - 0-501 550-550 – telephone number of the owner's partner
 - 0-39 77-88-99 – telephone number of the Service

Since the alarm control panel is connected to the subscriber line via the module, these numbers are to be programmed in the control panel as if the module did not exist (the letter "D" in the number indicates the mark of waiting for continuous dial tone):

- telephone numbers for messaging: "1110011",
 "2220022",
 "3330033",
 "0D602440440",
 "0D501550550".

The Service is accessible by dialing the following telephone number:

"0D39778899"

Configuring the module for such an operation requires programming the numbers and prefixes, and checking the settings of options, as given below:

- *Any number:* option OFF
- *Signal testing:* option chosen
- *Permanent prefix:* "602", "501", "39"
- *Prefix to erase:* "0"
- *Prefix to add:* "58"
- *Telephone numbers:* "581110011", "582220022", "583330033", "602440440", "501550550", "39778899"

The remaining prefixes and numbers should be blank.

Example 2:

- the module is connected to a PBX (private branch exchange), which has access to two subscriber lines (public telephone exchange lines) in Gdansk (area code – 58) after dialing the "outgoing numbers" 71 or 72; in addition, PBX has access to the trunk line KOMERTEL (code number – 39) after dialing the number 73.
- the calls via the module are to be allowed only to the following telephone numbers:
 - 111-00-11 – Security Dept.
 - 222-00-22 – Administration Dept.
 - 333-00-33 – residence telephone number of the owner
 - 0-602 440-440 – cellular telephone number of the owner
 - 0-501 550-550 – telephone number of the owner's partner
 - 0-39 77-88-99 – telephone number of the Service

While programming (at the alarm control panel) the telephone numbers for messaging, it is required to choose one of three ways of getting connection (the letter "D" indicates the mark of waiting for continuous dial tone):

"71D1110011" or "72D1110011" or "73D581110011"
 "71D2220022" or "72D2220022" or "73D582220022"
 "71D3330033" or "72D3330033" or "73D583330033"
 "71D0D602440440" or "72D0D602440440" or "73D602440440"
 "71D0D501550550" or "72D0D501550550" or "73D501550550"

The service can be rung up by dialing the following number:

"71DoD39778899" or "72D0D39778899" or "73D39778899"

In this case, the module is programmed as follows (items not shown below should be blank):

- *Any numbers* – option not chosen
- *Signal testing* – option chosen
- *Outgoing No.* – "71", "72", "73"
- *Permanent prefixes* – "602", "501", "39"
- *Prefix to erase* – "0"
- *Prefix to add* – "58"
- *Telephone numbers* – "581110011", "582220022", "583330033", "602440440", "501550550", "39778899"

Example 3:

- programming to enable the module to send SMS message to cellular telephone number: 602123123

Programming the module is as follows (items shown should be programmed):

- *Pager Tel. No.* – 1111
- *SMS centre No.* – 48602951111 (contact GSM representative for the correct number)
- *Prefix for SMS* – 48

The pager number to be programmed in the alarm control panel should have the following form (FS-87 to FS-90 in the control panel CA-6; FS-87 to FS-94 in the control panel CA-10):

1111602123123

The parameters of the paging system to be programmed in the alarm control panel should have the following form (FS-118 in the SATEL control panel CA-6 and CA-10):

1C 22 0A 0E 70 8A

Note: *The cellular network operator may require that the "+" character be entered before the country code (e.g., for Poland: +48 instead of 48).*

17. SPECIFICATIONS

Supply voltage	12 V DC \pm 15%
Outputs current-carrying capacity	4 x 50 mA
Current-carrying capacity, supply output (+V; -V).....	300 mA
Maximum current consumption in the telephone standby mode (without outputs supply)....	100 mA
Maximum current consumption in the GSM telephone active mode (without outputs supply)	250 mA
Required minimum output current of power supply unit.....	500 mA
Weight.....	952 g

ATTENTION: The SATEL Company recommends that performance of the GSM-4 communication module be regularly tested. An efficient GSM module, which interacts with the security system, greatly increases the chance of successful transmission of alarm information. However, for reasons beyond the Manufacturer's control, it cannot give 100% guarantees message delivery.

SATEL sp. z o.o.
ul. Schuberta 79
80-172 Gdansk
POLAND
tel. + 48 58 320 94 00
info@satel.pl
www.satel.eu