

Alarm Control Panel CA-4v1

MANUAL

Satel 

GDAŃSK
POLAND





WARNINGS

Due to safety reasons, alarm system should be installed by qualified personnel only.

Because alarm system may contain hazardous items, its components should be kept out of reach of unqualified personnel.

In order to avoid the risk of electric shock, read carefully this manual before proceeding to installation. Any connections should be made in deenergized state only (i.e. with power supply disconnected).

In the event of service operations consisting in fuse replacement, they must only be carried out after disconnecting the supply voltage. For the replacement, use only the fuses which have identical parameters as the original ones.

It is recommended that the manufacturer's required housings and power supply units be used.

Making any construction changes or unauthorized repairs is prohibited. This applies, in particular, to modification of assemblies and components.

CAUTION !

It is impermissible to connect a fully discharged battery (voltage on terminals without a load less than 11V) to the alarm panel. To avoid hardware damage, fully discharged or never used battery should be charged initially using proper charger.

Latest EC declaration of conformity and product approval certificates can be downloaded from our Web site www.satel.pl



CA-4V1 panel description

The alarm panel CA4-v1 is designed for small alarm systems. It is made in advanced microchip technology in accordance with the latest trends in burglary signaling.

Its features:

- new generation, interference-resistant microchip,
- 4 programmable parametrical zones,
- 2 independent alarm outputs with programmable operation time,
- the possibility of attaching up to 3 keypads showing system,
- 2 main access codes (4 to 6 digits long) for basic control of the panel (i.e. arming and disarming, codes setting, zone bypassing)
- one code for arming the system with bypassing the programmed zones ("stay arming"),
- one-time code for single arming and disarming the system,
- additional servicing code for accessing basic programming functions of the panel,
- extended control of the system status assuring its error-free operation: fuse status tests, signaling devices wiring tests, battery charge level and AC power control,
- acoustic in-keypad signaling of trouble, alarm and exit time countdown,
- possibility of arming the system with sirens disabled (alarm condition is signaled in the keypads only),
- PANIC type alarm,
- alarm after three unsuccessful attempts of entering access code,
- memory log for 7 most recent alarms,
- memory of the panel status before power/battery disconnection,
- non-voltage memory of all panel's parameters and programmed data.

Installation of the control panel

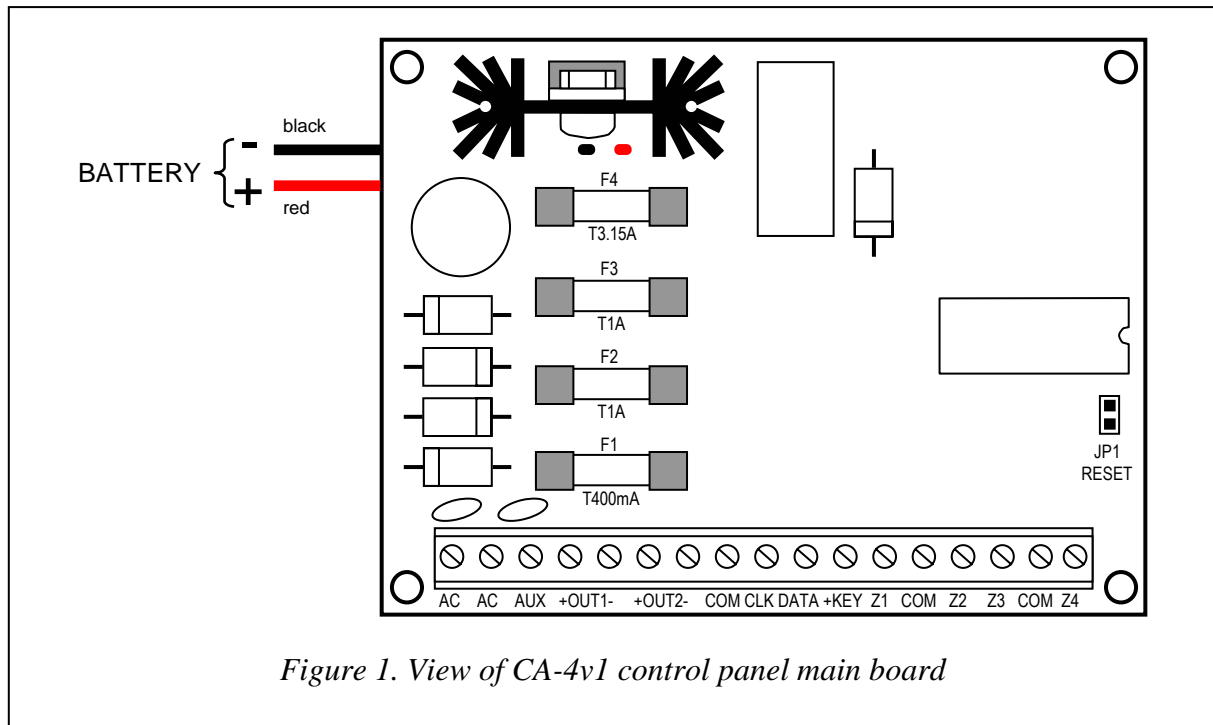

Figure 1. View of CA-4v1 control panel main board

BOARD TERMINALS:

AC	– module power supply inputs (17...24V AC)
AUX	– detectors power supply output (+12V DC)
Z1 to Z4	– zones
OUT1 to OUT2	– signaling outputs
+KEY	– keypad power supply output
DATA, CLK	– keypad bus terminals
COM	– ground

It is required that the control panel be permanently connected to the mains power. Therefore, prior to starting the work on the system cabling, make yourself familiar with the electrical installation of the site and select a circuit which is permanently alive to power the control panel. The circuit is to be protected with an appropriate fuse.

CAUTION!

The control panel is power supplied from the 230V AC mains. Carelessness or wrong connection may result in electric shock and pose a threat to life!

Therefore, exercise particular caution when connecting the control panel. In the process of installation and connection of the control panel, the cable to be used for mains supply must not be alive!

Connection of power supply

1. Connect the 230V alternating voltage leads to the transformer terminals marked "AC 230V".
2. Connect the output voltage wires of the transformer secondary winding to the "AC" terminals on the control panel main board.
3. Connect the wire of the electric shock protection circuit to the terminal block provided next to the transformer and marked with the ground symbol .

CAUTION!

As the control panel has no isolating switch to disconnect the mains supply, it is important that the owner or the user of the security system be informed on how the system is to be disconnected from the mains (e.g. by indicating the fuse which protects the control panel supply circuit).

The panel on-board DC power supply default setting is 13.6–13.8V and should not be changed.

Connection of keypad

The CA-4v1 control panel interfaces with LED keypads. The keypad should be connected to the system with a four-wire line. If the panel is meant to work with several keypads, they should be connected in parallel (up to tree keypads can be connected to the panel with the guarantee of its error-free operation). The maximum distance between keypads and the panel (assuming YTDY 6x0.5 wires are used) is 200m. Each of the keypads should be power-fed with its own wire.

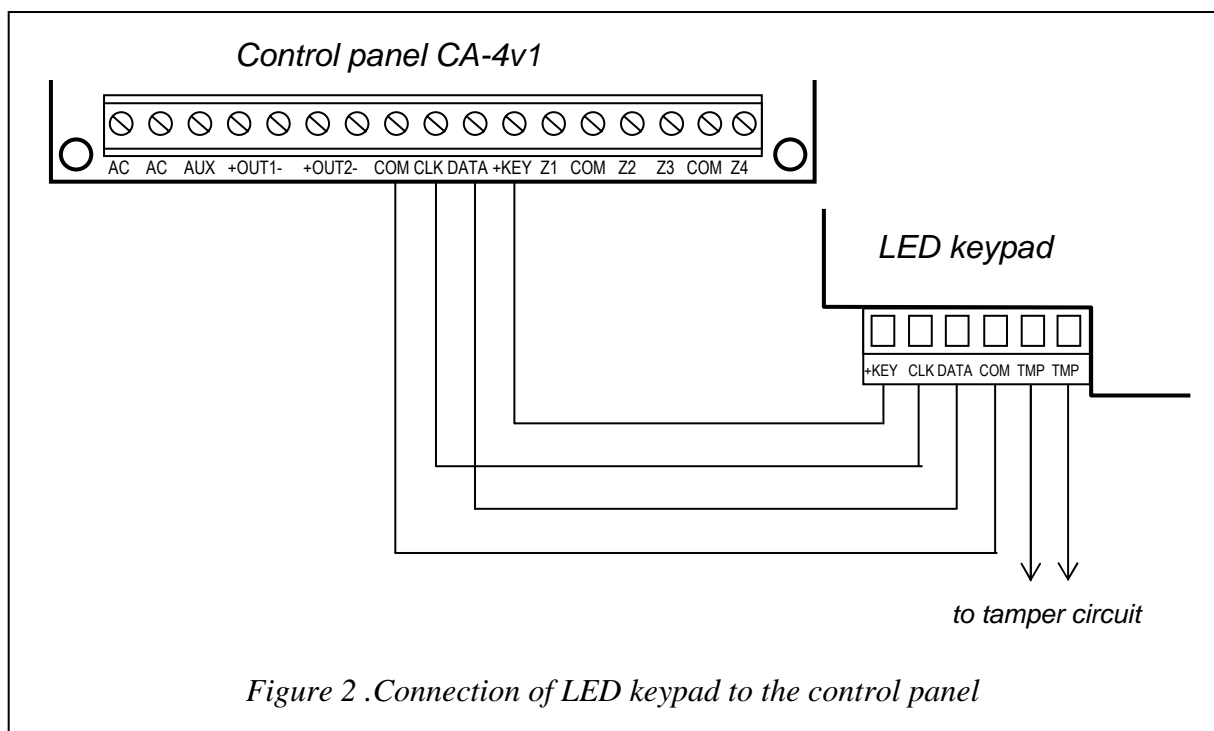

Connection of detectors

Detector wires should be connected to proper terminals on the main board. The way of connection 2.2kΩ EOL resistor shown on the scheme. For powering the detectors is intended to be used the AUX output. TMP terminals should be connected to a tamper circuit.

Connection of signaling devices

The signaling devices should be connected to OUT1 and OUT2 outputs. In the devices the 2.2kΩ resistors should be connected in parallel to enable the panel to control the signaling devices wiring. If few signaling devices are connected parallel to one output, the resistor should be mounted in the furthest signaling device from the control panel.

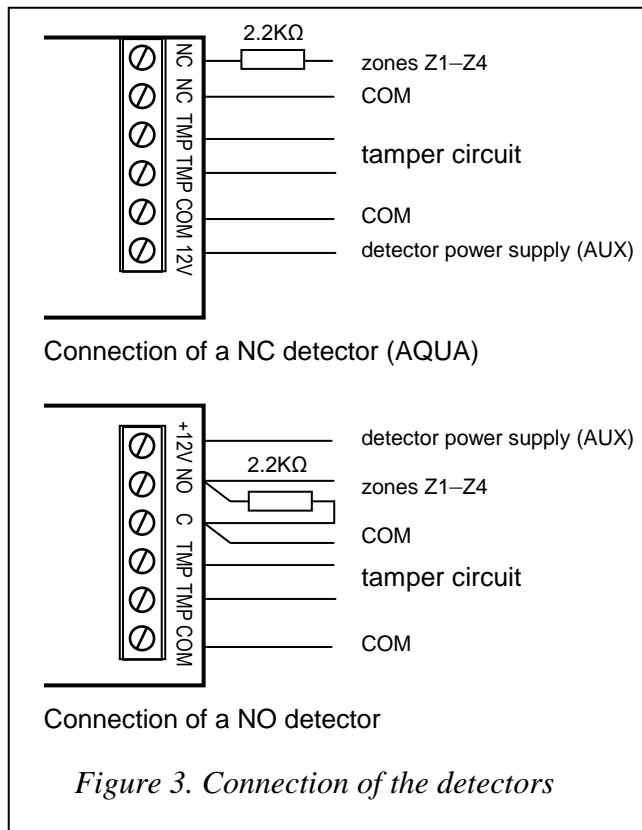

Caution:

- The signaling devices wires control cannot replace an tampering circuit which should be used to protect them.

The OUT1 and OUT2 outputs control the ground terminal. The +12V voltage is led through F2 and F3 fuses to +OUT1 and +OUT2 terminals. The -OUT1 and -OUT2 terminals are cut off in inactive state, in active state (alarm signaling) they are shorted to ground (0V).

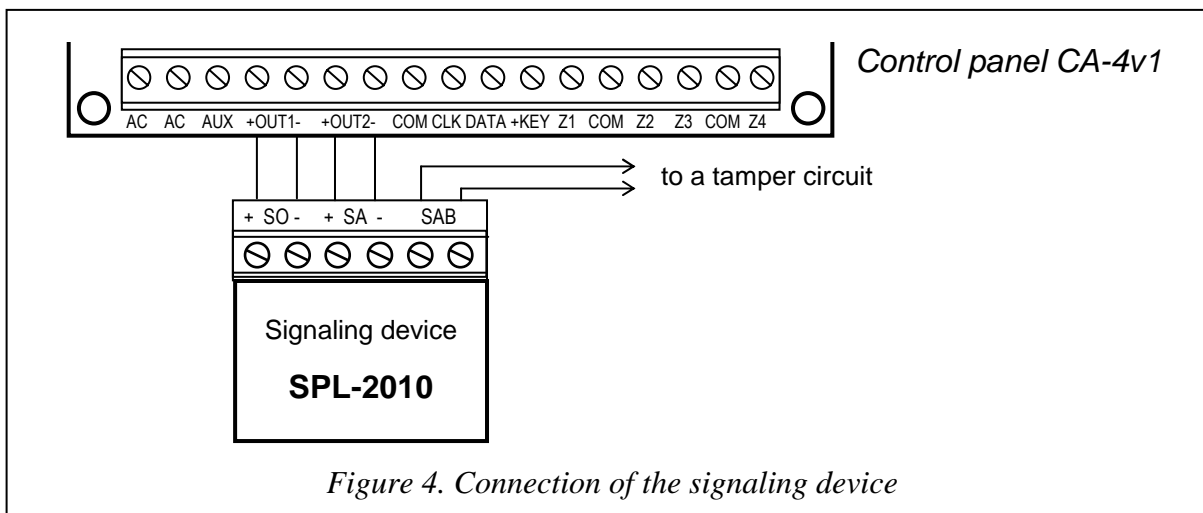

After all the parts are carefully and properly connected the system can be power up. It is recommended to start the alarm system only with power supply, without a battery connected.

Description of the LED keypad

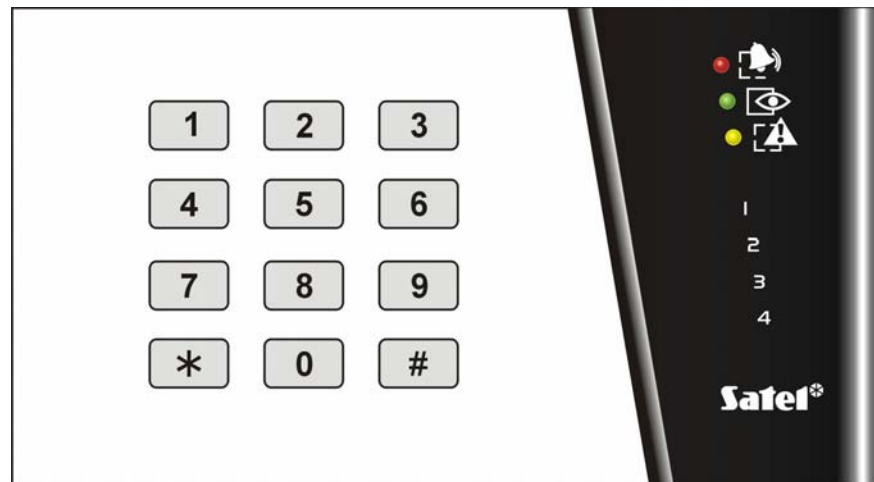



Figure 5. View of a LED Keypad

Sound signals produced by the keypad

- a) While working with the keypad the following sounds may be generated:
- 1 short** – key pressed confirmation,
 - 2 short** – correct access code entry confirmation before function number selection,
 - 3 short** – confirmation of the successful completion of an operation (for example arming/disarming of the system, function selection, successful programming completion),
 - 2 long** – error signal (for example: wrong password, entering wrong key sequence, exiting the function programming session without saving the parameters through depressing a key).
- b) The remaining situations (the sound signal is repeated every second):
- 1 short** – the entry delay time countdown,
 - 2 short** – the panel detected a trouble –  [TROUBLE] LED is on (sound signal can be temporary switched off by pressing the [*] key; signaling will be activated automatically after a new trouble event occurs)
 - 3 short** – alarm signalling (active till cancelled through the keypad),

Cautions:

- the entry delay time countdown is signaled after activating the function (see ADDITIONAL FUNCTIONS),
- in armed mode trouble sound signalling is not active.

LED signaled states



ALARM (red color) – alarm is signaled by the LED blinking. The LED goes out after alarm reset. (see Disarming, Cancelling alarm).



ARMED (green color) – the LED is ON with the system armed. The blinking LED indicates the countdown of the exit delay time.



TROUBLE (yellow color) – blinking LED indicates a failure in the alarm system. The type of trouble can be identified with function 7.



– (red color) LEDs indicating the status of system zones:

- ON – zone violated,
- blinking slowly – zone bypassed (indicated only with the partition disarmed).

The jumper pins on the keypad board are designated for setting a keyboard backlighting.

Basic functions

Arming

Enter one of the access codes (except the servicing code) and then press the [#] key. The panel will confirm the correct code entry with three short beeps and will start to countdown the exit delay time. During the countdown the  [ARMED] LED is blinking, and after armed mode is activated it is lit continuously.

Disarming

Enter one of the access codes (except the servicing one) and then press the [#] or [*] key. The panel will confirm the correct code entry with three short beeps and the armed mode will be deactivated. The  [ARMED] LED will extinguish.

Canceling the alarm







Is similar to disarming the system. If the alarm was activated in armed mode along with canceling the alarm the armed mode is deactivated.

PANIC alarm

Press and hold the [#] key for about 3 seconds. The function can be blocked (see ADDITIONAL FUNCTIONS)

Access code programming (functions 1, 2, 3, 4)

The default user first access code is 1234. The code should be changed for a safety reasons with *function 1* right after starting the system.

To changing or programming code enter one of the two master access codes and press the [*] key. The panel will confirm the correct code entry with two short beeps and will wait for the number of the access code to be programmed. In addition, the  [TROUBLE],  [ARMED] and  [ALARM] LEDs will blink simultaneously. Giving the number (1 through 4) will activate the programming mode. The panel will confirm the programming mode with three short beeps. The  [TROUBLE],  [ARMED] and  [ALARM] LEDs will blink in turns. A new access code should be entered and confirmed with the [#] key. The access code should be 4 to 6 digits long.







The access codes 1 and 2 are master codes.

The access code number 3 is designed to enable arming the system with bypassing the zones programmed with function 9 and armed mode without outside signaling devices activated (the alarm condition is signaled solely in the keypad, the option is deactivated with function 8).

The access code 4 can be used once only (the panel clears it after one-time entry).







The access codes 2, 3 and 4 can be cleared by pressing the [#] key immediately after activating the service programming mode.

Bypassing zones (function 5)





Enter one of the two master codes and press the [*] key. The panel will confirm the correct code entry with two short beeps and will wait for the function number entry (the  [TROUBLE],  [ARMED] and  [ALARM] LEDs will blink simultaneously). Press the 5 key (the panel will confirm the entry with three short beeps, the  [TROUBLE],  [ARMED] and  [ALARM] LEDs will blink in turns). Zone numbers to be bypassed should be entered. While programming the LEDs representing the bypassed zones will be on. After setting the bypass function for the selected zones the [#] key should be pressed.

Caution: the panel will signal an error if bypassing the 24-hour zone is attempted.

Reviewing the alarm memory log (function 6)

Enter one of the two master access codes and press the [*] key. The panel will confirm the correct code entry with two beeps and will wait for the function number entry (the  [TROUBLE],  [ARMED] and  [ALARM] LEDs will blink simultaneously). The 6 key should be pressed. The  [ALARM] LED will start blinking, and the remaining LEDs will indicate the origin of the last alarm (the  [ARMED] LED will indicate the alarm activated by entering three incorrect access codes, the  [TROUBLE] LED will indicate PANIC type alarm). Pressing any of the keys (except [*]) will classify the previous alarm. The panel logs the last three instances of alarm condition. Pressing of the [*] key exits the function.







Identifying trouble type (function 7)

If the  [TROUBLE] LED is on, the panel detected a trouble condition. The type of trouble is indicated after choosing function 7. In order to do that enter one of the two master codes and press the [*] key. The panel will confirm the correct code entry with two beeps and will wait for the function number entry (the  [TROUBLE],  [ARMED] and  [ALARM] LEDs will blink simultaneously). Press the 7 key. The  [TROUBLE] LED will start blinking, and the remaining LEDs will indicate the type of trouble.

- **LED 1** – detector power supply fuse (F1) trouble,
- **LED 2** – output OUT1 fuse (F2) trouble or disconnecting the signaling device attached to OUT1 output,
- **LED 3** – output OUT2 fuse (F3) trouble or disconnecting the signaling device attached to OUT1 output,
- **LED 4** – battery fuse (F4) trouble or low battery,
-  [ALARM] LED – no AC power supply.

Caution: the function can be used only when the  [TROUBLE] LED is on.







Setting the ADDITIONAL FUNCTIONS (function 8)

Enter one of the two master codes and press the [*] key. The panel will confirm the correct code entry with two beeps and will wait for the function number entry (the the  [TROUBLE],  [ARMED] and  [ALARM] LEDs will blink simultaneously). Press the 8 key. The panel will signal programming mode activation with three short beeps, the  [TROUBLE],  [ARMED] and  [ALARM] LEDs will blink in turns and the 1÷4

LEDs will indicate which of the functions are activated (a LED on signals activity of a function). The number of the function to be blocked or unblocked should be entered. After unblocking of the chosen functions the [#] key should be pressed. The following functions are possible:

- 1 alarm upon entering three wrong access codes,
- 2 PANIC alarm available,
- 3 the entry delay countdown signaling,
- 4 access code number 3 activates silent armed mode (signaling with the devices attached to outputs OUT1 and OUT2 is deactivated – the alarm condition is signaled through the keypad sounder).

The zones bypassed with access code 3 arming (function 9)

Enter any of the two master access codes and press the [*] key. The panel will confirm the correct code entry with two beeps and will wait for the function number entry (the  [TROUBLE],  [ARMED] and  [ALARM] LEDs will blink simultaneously). Press the 9 key. After entering the programming mode (the panel will confirm the entry with three beeps, the  [TROUBLE],  [ARMED] and  [ALARM] LEDs will blink in turns) the zones' numbers to be additionally bypassed should be entered. After programming the panel the [#] key should be pressed.

Programming

Programming the panel enables its users to adjust it to specific requirements of an alarm system.

In CA4-V1 the following parameters are user-programmable:

- bypassing zones (for example, not used),
- set delay zones (for protected facility easy entry),
- set 24-hour zones,
- entry delay time,
- exit delay time,
- the OUT1 output alarming time,
- the OUT2 output alarming time, or the signaling mode of the output.

Programming is possible with 10 service functions which are available the panel's activation in the service programming mode with a special service code. The mode is sustained until deactivated with an appropriate function.

On entering the programming mode the panel blocks any alarms showing only zone status. The  [TROUBLE],  [ARMED] and  [ALARM] LEDs blink simultaneously and on activating the function program the LEDs blink in turns.

Service functions

Below there is a list of all available service functions. The panel sound reactions to keys pressed are marked with dots where one dot = one beep.

If the reaction to a key pressed are two long sounds it means that the wrong key has been used. In such case the parameter being programmed won't be changed.

FUNCTION 0 – exit service mode

Activating sequence: 0.#...

FUNCTION 1 – service code programming

Activating sequence: 1.#...

Example: programming new code: 89354
8.9.3.5.4.#...

FUNCTION 2 – permanent zone bypassing

Activating sequence: 2.#...

Example 1: bypassing zone number 2 and 3
2.3.#...

Example 2: unbypassing zone 3
3.#...

FUNCTION 3 – 24 hour zones (are active although the system is not armed)

Activating sequence: 3.#...

Example: zone 4 is to be changed into 24 hours type
4.#...

FUNCTION 4 – delayed zones (the zones of this type activate the alarm after the time specified by using function 6)

Activating sequence: 4.#...

Example: zone 1 and 2 are to be changed into delayed type
1.2.#...

FUNCTION 5 – programming the exit delay time (from 0 to 99 seconds)

Activating sequence: 5.#...

Example: the exit delay time is to be set to 30 seconds
3.0...

FUNCTION 6 – programming the entry delay time (from 0 to 99 seconds)

Activating sequence: 6.#...

Example: the entry delay time is to be set to 8 seconds
0.8...

FUNCTION 7 – programming the alarm time at OUT1 output (from 001 to 999 seconds, for 000 the exit is active even until the alarm has been cancelled)

Activating sequence: 7.#...

Example: the alarm time is to be set to 5 minutes (300 seconds)
3.0.0...

FUNCTION 8 – programming the alarm time at OUT2 output (the output signals the alarm after being programmed to 001 through 998 seconds) or the way of armed status signaling (000 – 0V at OUT2 when the panel is armed; 999 – +12V at OUT2 when the panel is armed).

Activating sequence: 8.#...

Example: the alarm time is to be set to 5 seconds
0.0.5...

FUNCTION 9 – default settings restore. The following values are pre-programmed:

access code 1

1234

access code 2

not pre-programmed

access code 3	not pre-programmed
access code 4	not pre-programmed
service code	12345
zones bypassed	none
zones delayed	1
24 hour zones	4
exit delay time	5 seconds
entry delay time	10 seconds
alarm time at OUT1	5 seconds
alarm time at OUT2	10 seconds

Activating sequence: 9.#.. ...

Arm/Disarm status information

If arm/disarm status can be signaled with the OUT2 output, default setting may be changed using function 8. Normally, the output signals an alarm after the alarm time being programmed (from 001 to 998 seconds). If value **000** or **999** is entered, the function of the output is to signal arm/disarm status.

- Value 000 means that OUT2 will set the voltage to 0V (relative to the COM terminal) when the panel is armed.
- Value 999 means that OUT2 will set the voltage to 12V when the panel is armed.

The bias resistor (for example 1kΩ), that limits the input current from terminal +OUT2, must be connected to the output.

Activating sequence: 8.#.. ...

Example: programming of the armed mode signaling (while in armed mode the OUT2 will be set to 12V)
9.9.9.

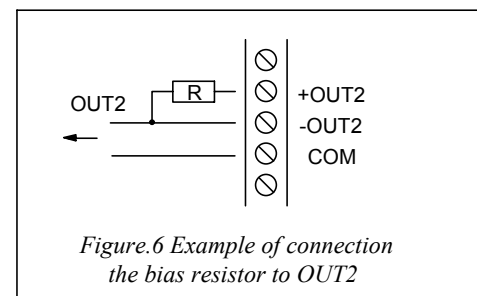

Resetting the panel

If the user forgets the access codes, entering service mode is possible through the following procedure:

1. disconnect the net and battery power supply sources,
2. short the JP1 RESET jumper pins (see figure 1),
3. connect the power supply,
4. after three short beeps in the keypad remove the JP1 jumper from the pins,
5. call function 9 to restore manufacturer settings and program the remaining parameters (using service functions 2 through 8).

Technical description

main board supply voltage	AC 17...24V
control panel DC power supply rated voltage	DC 13.6...13.8 V
DC power supply total current efficiency.....	1A
backup power supply	battery 12V/7Ah
battery charging current (changeover)	250mA
panel power consumption.....	23mA
keypad power consumption	32mA
guaranteed capacity of keypad output.....	3 keypads
detector power supply outputs.....	400mA delayed fuse protection
outputs OUT1 and OUT2.....	1A delayed fuse protection
battery protection	3.15A delayed fuse protection
number of zones.....	4
zone type	end of line resistor
EOL resistor.....	2.2kohm
entry parameter tolerance.....	+/-25%
number of delayed zones	1 through 4
number of 24 hour zones.....	1 through 4
exit delay time.....	0 through 99s
entry delay time	0 through 99s
alarm time at OUT1	1 through 999s (about 16.5 min.) or until cleared
alarm time at OUT2	1 through 998s (about 16.5 min.)
alarm memory log capacity.....	7 most recent alarms
board dimension	102x76mm
weight	92g

TABLE OF PROGRAMMING

– functions available after entering service code								
0	End of service mode							
1	Service code	1	2	3	4	5		
				Z1	Z2	Z3	Z4	
2	Permanent bypassed zones							
3	24-hour zones						x	
4	Delayed zones (enter/exit)			x				
5	Exit delay time	05	00–99 seconds					
6	Entry delay time	10	00–99 seconds					
7	Alarm time at OUT1	005	001–999 seconds 000 – alarm to cancelling					
8	Alarm time at OUT2	010	001–998 seconds 000 – 0V at OUT2 when is armed 999 – +12V at OUT2 when is armed					
9	Default settings restore							
– functions available after entering user master code								
1	User code (master)	1	2	3	4			
2	User code (master)							
3	User code							
4	User code (one time use)							
				Z1	Z2	Z3	Z4	
5	The zones bypassed by user							
6	Reviewing of the 7 last alarms memory log (the LED indicates the origin of the alarm): [digit] – previous alarm; [*] – exit the function			Z1	Z2	Z3	Z4	
				👁️ [ARMED] – 3 wrong access codes		🚨 [TROUBLE] – PANIC type alarm		
7	Identifying trouble type – LEDs indicate the type of trouble (available only when 🚨 [TROUBLE] LED blinking)			F1	F2	F3	F4	
				AUX	OUT1	OUT2	battery	
				🔊 [ALARM] – no AC power supply				
8	Additional functions		Alarm upon entering 3 wrong access codes				Z1	
			PANIC alarm available – press [#] key				Z2	
			The entry delay countdown signaling – sounds				Z3	
			Access code 3 – alarm only in keypad (silent armed mode)				Z4	
				Z1	Z2	Z3	Z4	
9	The zones bypassed automatically after entering access code 3							

Default settings are wrote or marked x in right bottom corner of field assigned to be filled.

The user functions can be called only with the master code (functions 6 and 7 without parameters):

[master user access code][*][number of function][parameter][#]

After entering a service mode **[service code][#]** (or **[service code][*]**) the functions (without function 9) are calling by:

[number of function][#][parameter][#] or **[number of function][#] [parameter]**

[0][#] – end of programming in service mode.

SATEL sp. z o.o.
ul. Schuberta 79
80-172 Gdańsk
POLAND
tel. + 48 58 320 94 00
info@satel.pl
www.satel.pl