



ISDN Module

USER MANUAL

Program version 1.06



isdn_e 01/06



IMPORTANT



The equipment requires an external 12 V DC power supply unit with 500mA current capacity.

Making any construction changes or unauthorized repairs is prohibited.

Prior to putting the equipment into operation, please read this manual carefully.

The mainboard of ISDN module contains electronics sensitive to electrostatic discharge. Prior to installation, remove the electrostatic charge, and be careful not to touch any components on the module board during the installation.

Incorrect configuration of the ISDN module may result in generation of unwanted telephone calls and, consequently, it may increase the equipment operating costs.

DECLARATION OF CONFORMITY		
Product: ISDN module	Manufacturer: SATEL spółka z o.o. ul. Schuberta 79 80-172 Gdańsk, POLAND tel. (+48 58) 320-94-00 fax. (+48 58) 320-94-01	
Product description: The ISDN module is a device suitable for interaction with the ISDN network on S/T interface. It works as a TA (terminal adapter) type of equipment, enabling devices designed for operation with analog telephone lines to be connected to the ISDN network.		
The product is in conformity with the following EU Directives: LVD 73/23/EEC+93/68/EEC EMC 89/336/EEG + 91/263/EEC, 92/31/EEC, 93/68/EEC R&TTE 1999/5/EC		
The product meets the requirements of harmonized standards: LVD: PN – EN 4100:2001 EMC: ETSI EN 300 386: v.1.3.2:2003; ETSI EN 300 386-2: v.1.1.3:1997 R&TTE: TBR3; ETSI ETS 300 012 (1992) + A2 (1996); ETSI ETS 300 153 (1992) + A1 (1995) [NET 3 part 1]; ETSI ETS 300 104 (1991) +A 1 (1994) [NET 3 part 2].		
Conformity with requirements of the Directives has been established on the basis of tests conducted in the accredited laboratories: regarding the EMC&LVD Directives: in the Testing Laboratory, Dept. of Electrical Engineering Institute, Gdańsk; regarding the R&TTE Directives: in the Teleinformatic Equipment Testing Laboratory, Communication Institute, Warsaw, the Laboratory seated in Gdańsk. LVD report No.: 133/LBS – 845/2004 EMC report No.: 129/LMC – 845/2004 R&TTE report No.: 08 50 0014 + technical opinion 207/2004		
Gdańsk, Poland	01.10.2004	Head of Test Laboratory: Michał Konarski 
Latest EC declaration of conformity and certificates are available for downloading on website www.satel.pl		

CONTENTS

1. Module Features.....	2
2. Module Description.....	2
3. Connecting the module.....	3
3.1 Connecting the power supply.....	3
3.2 Connecting the alarm control panel.....	3
3.3 Connecting the module to ISDN network.....	5
3.3.1 Preparation for work in point-to-multipoint configuration.....	5
3.3.2 Preparation for work in point-to-point configuration.....	8
4. Equipment Factory Settings.....	8
5. Modification of ISDN Module Settings with AT Commands.....	9
6. AT Commands Accepted by ISDN Module.....	9
7. Technical data.....	11
8. History of the manual updates.....	11

1. Module Features

- Operation as a terminal adapter, which enables the alarm control panel to be connected to an ISDN line without any changes in configuration of the panel or the monitoring station.
- Option to work in configurations "point-to-multipoint" and "point-to-point".
- Option to use the same ISDN line, to which other ISDN equipment is connected (e.g. telephones, faxes, modems).
- Option to set priority for connections initiated by the control panel.
- Monitoring for presence of ISDN line.
- Support of tone dialing.
- Digital data transmission in V.110 format in case the equipment is used as an external modem.
- Configuration by means of AT commands sent through the RS-232 port if the equipment is used as an external digital modem.
- 12V DC supply, typical for the alarm & security systems.

2. Module Description

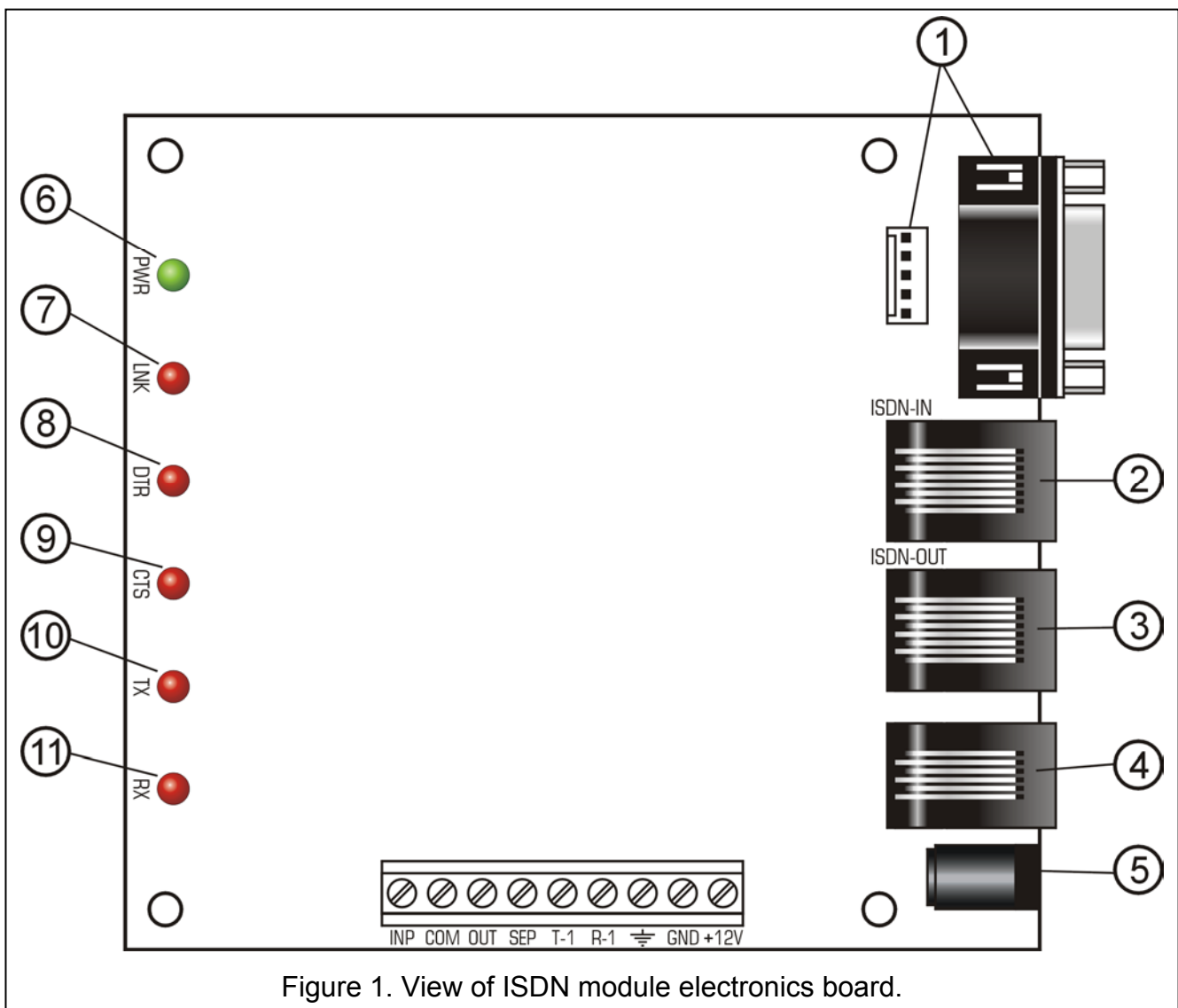

Legend to Fig. 1:

- 1 – RS-232 connectors
- 2 – RJ-45 connector, designated ISDN-IN – ISDN telephone line input;
- 3 – RJ-45 connector, designated ISDN-OUT – ISDN telephone line output;
- 4 – RJ-11 connector – analog telephone line output;
- 5 – power socket;
- 6 – PWR LED - power supply;
- 7 – LNK LED – ISDN line;
- 8 – DTR LED – DTR line status of RS-232 port - module readiness to receive data from a device connected to the RS-232 port (e.g. alarm control panel);
- 9 – CTS LED – CTS line status of RS-232 port - readiness of the device connected to the RS-232 port (e.g. alarm control panel) to interact with the module;
- 10– TX LED – sending data through the RS-232 port;
- 11– RX LED – receiving data through the RS-232 port.

Description of terminals:

- INP - control input – alarm signal from the control panel
- COM - common ground
- OUT - 12V output for separator to cut off equipment from telephone lines – connect to separator IN input
- SEP - control output for separator to cut off equipment from telephone lines – connect to separator SEP input
- T-1, R-1 - analog telephone output (e.g. to connect the alarm control panel)
- ⊕ - ground
- GND - power supply common
- +12V - +12V power supply

3. Connecting the module

3.1 Connecting the power supply

The equipment is supplied with +12V DC voltage. The power supply can be connected to the onboard terminals (+12V and GND) or to the power socket. **Never connect power supply both to the terminals and to the socket at the same time.** Correct power connection is indicated by lighting of the PWR LED.

3.2 Connecting the alarm control panel

The telephone line connecting the control panel and the ISDN module may be connected to the onboard terminals (T-1 and R-1) or to the RJ-11 telephone socket. **Never connect the analog telephone line both to the terminals and to the socket at the same time.**

If the module is used as an external digital modem by the CA-64 or INTEGRA alarm control panel, the two units should be additionally connected with the RS-232 cable. **Length of the RS-232 cable should not exceed 2.5 m. Never connect any equipment to both RS-232 sockets of the module at the same time.** Configuration of the ISDN modem is carried out

by means of the AT commands. The ISDN modem automatically recognizes the RS-232 speed, the following speeds being supported: 4800Bps, 9600Bps, 19200Bps.

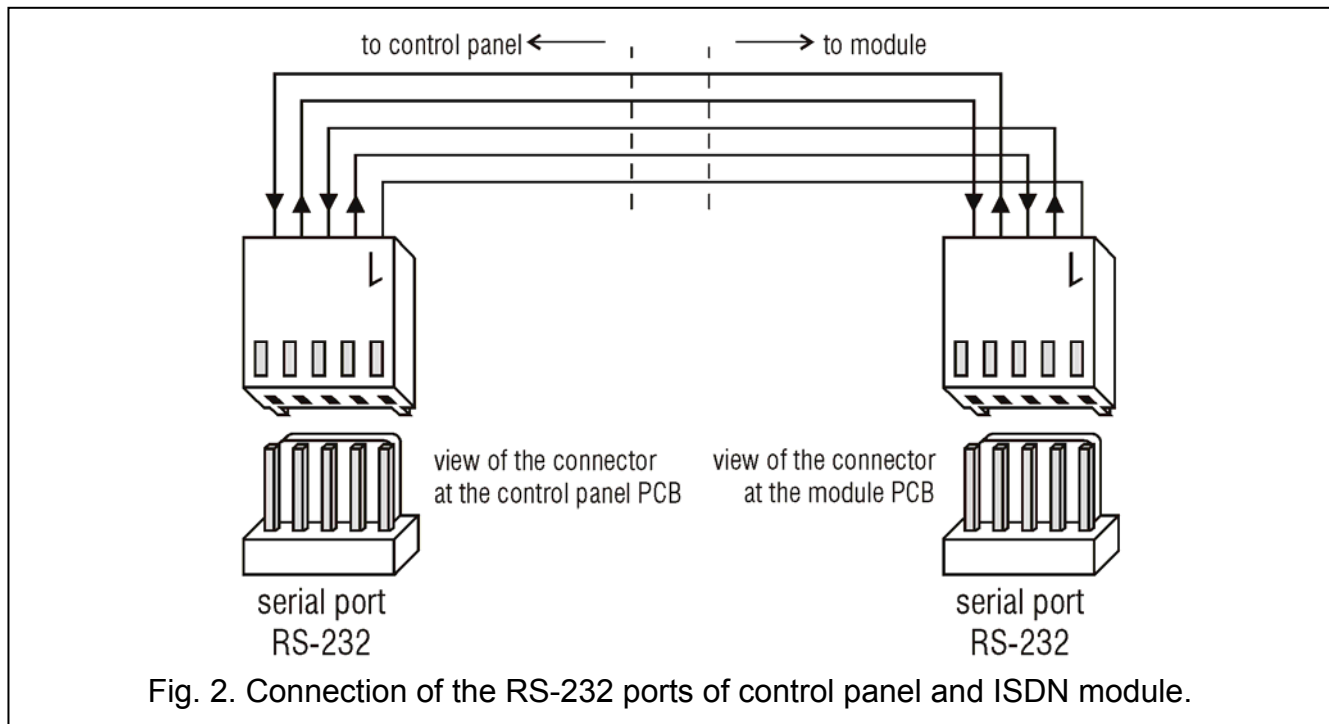

The ISDN module is provided with a feature ensuring priority to the control panel outgoing connections. To enable the control panel to make a connection, the other telephone lines may be cut off.

The module factory settings with regard to cutting off the telephone lines (\$C0) are based on the assumption that the ISDN module works in the point-to-multipoint configuration (\$M1) (see section "Connecting the module to ISDN network"), and that the signal is connected to the ISDN module from the control panel. It is recommended that the signal be connected from the control panel OC output (signal polarization: active status 0V; the output programmed as alarm one) to the INP and COM terminals of the ISDN module. With such settings the ISDN module will cut off the ISDN line from the other devices only when the control panel intends to make an alarm call, but it is impossible due to the line being occupied by other subscriber devices. When the ISDN line is busy, and the outgoing connection initiated by the control panel is not an alarm call, the ISDN module will not cut off the line to the other subscriber devices, but will be waiting until the line is available.

If the alarm signal cannot be supplied to the ISDN module, it is recommended that you change the line cut-off default settings to \$C1, or leave the factory settings (\$C0) and short-circuit the INP and COM terminals. Both the \$C1 setting and shorting the INP and COM terminals with the \$C0 setting will result in recognizing each connection initiated by the control panel as the alarm call, and if the line is busy, all the other subscriber devices will be cut off.

Telephone communication will be restored on all lines if no repeated demand to access the telephone line is made within 10 seconds after the control panel hangs up. However, if the panel fails to transfer all the programmed codes and messages, i.e. if at least one of the connections has not been established because of the receiver line busy status, the telephone communication will only be restored on all lines within 60 seconds after the control panel hangs up.

In the point-to-point configuration (\$M0) (see section "Connecting the module to ISDN network"), the outgoing call initiated by the control panel will always require that the line be

cut off from the other subscriber devices, therefore it is recommended in this configuration that you use the (\$C1) setting, or short-circuit the INP, COM terminals with the \$C0 setting.

3.3 Connecting the module to ISDN network

Correct connection of the module to the ISDN network, as well as selection of appropriate settings, depend on the ISDN network configuration, the user is offered by the provider of telecommunication services. There are two ISDN network configurations available on the market, namely:

- point-to-multipoint configuration (usually offered to an individual customer),
- point-to-point configuration (often used by corporate customers, because of the possibility to connect PABX equipment).

Prior to starting installation, you should determine the ISDN network configuration. The SATEL ISDN module is programmed by default for operation in the point-to-multipoint configuration. For the point-to-point configuration, it is necessary to program new module settings by means of AT commands and save the settings.

3.3.1 Preparation for work in point-to-multipoint configuration

A characteristic feature of the point-to-multipoint configuration (\$M1) is the possibility of connecting many devices directly to the NT network termination module. When connecting the ISDN module, you must take into account the maximum number of devices supported by the NT network termination module (usually 8). The ISDN module is recognized as one of the digital devices. The specific character of ISDN network in the discussed configuration allows for simultaneously making up to two connections on the B-channels. This means that the network can be simultaneously used by not more than 2 devices (e.g. 2 telephones or a telephone and fax). However, it can happen that both B-channels are used by one device (e.g. a modem connecting to the internet). In order to ensure tamper protection and correct interaction between the ISDN network, ISDN module, control panel, and the other subscriber devices, it is necessary to observe the essential principle of installation: the ISDN module must be the first device connected to the S/T interface of the NT network termination module. All the other subscriber devices (both analog and digital) must be connected by means of the ISDN module and, if necessary, ISDN separator.

Use the RJ-45 socket marked as the ISDN-IN to connect the module to the digital telephone network. Connect the equipment to the S/T interface of the network termination according to the network termination manufacturer's directions. **Length of the cable connecting the ISDN module with the network termination should not exceed 2.5 m.** Active state of the S/T interface of the network termination is indicated by lighting of the LNK LED.

Probably the most frequently encountered case is connection by means of the ISDN module to the ISDN network of the control panel and one digital subscriber device and/or one analog subscriber device. Diagram of such an installation is shown in Fig. 3.

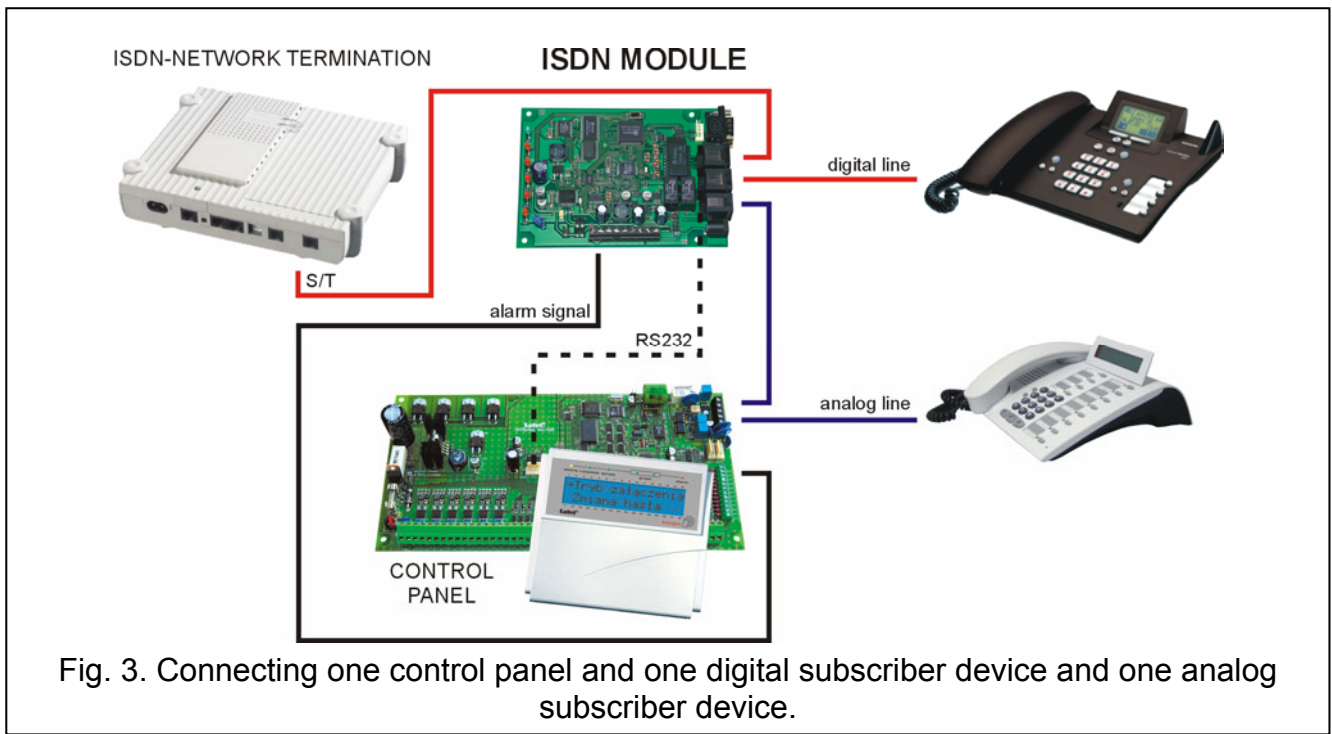

Fig. 3. Connecting one control panel and one digital subscriber device and one analog subscriber device.

Where the ISDN module is used as an adapter which enables the control panel to be connected to the ISDN network, the digital equipment should be connected to the ISDN module socket marked as the ISDN-OUT. Such a connection protects the alarm system against tampering.

Connecting a larger number of subscriber devices is more complicated. In such a case, an ISDN separator must be used.

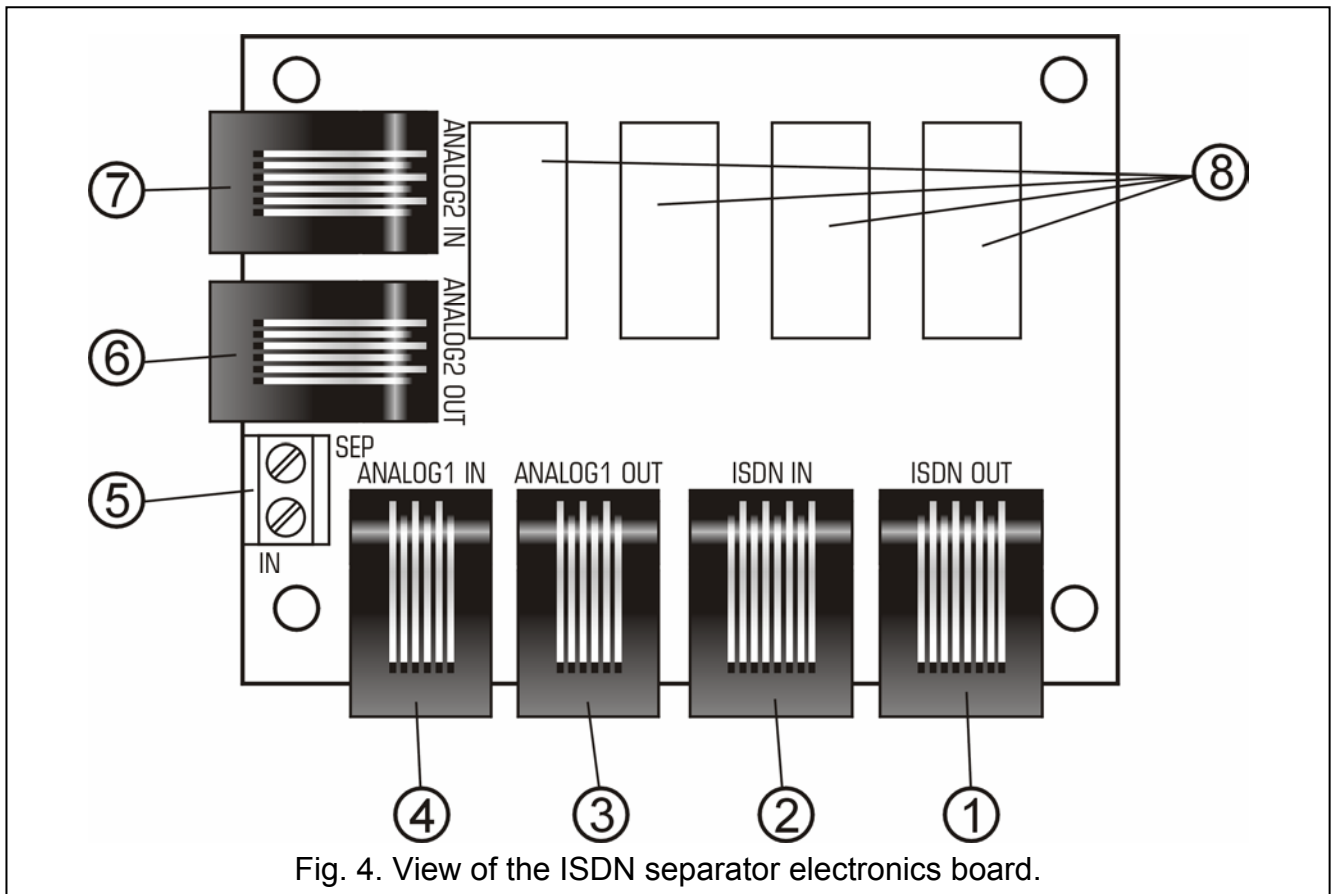

Fig. 4. View of the ISDN separator electronics board.

Legend to Fig. 4:

- 1 – RJ-45 connector, designated ISDN OUT – ISDN telephone line output;
- 2 – RJ-45 connector, designated ISDN IN – ISDN telephone line input;
- 3 – RJ-11 connector, designated ANALOG1 OUT – output, analog telephone line 1;
- 4 – RJ-11 connector, designated ANALOG1 IN – input, analog telephone line 1;
- 5 – SEP and IN terminals for connecting control signal from ISDN module;
- 6 – RJ-11 connector, designated ANALOG2 OUT – output, analog telephone line 2;
- 7 – RJ-11 connector, designated ANALOG2 IN – input, analog telephone line 2;
- 8 – relays.

The ISDN separator is to be connected to the ISDN module with two wires: connect the OUT terminal of the ISDN module to the IN terminal of the separator, and connect together the SEP terminals of both devices. The separator is fitted with a pair of RJ-45 ports for connecting one additional digital subscriber device, and two pairs of RJ-11 ports for connecting two additional analog subscriber devices. As the commercially available NT modules have, usually, two connectors for digital devices (so-called S/T interface) and two connectors for analog devices (so-called a/b interface), the design of ISDN module and the use of SATEL ISDN separator ensure a tamper protection through exercising control of all the four lines made available by the NT network termination module. An example of connecting additional subscriber devices via the ISDN separator is shown in Fig. 5.

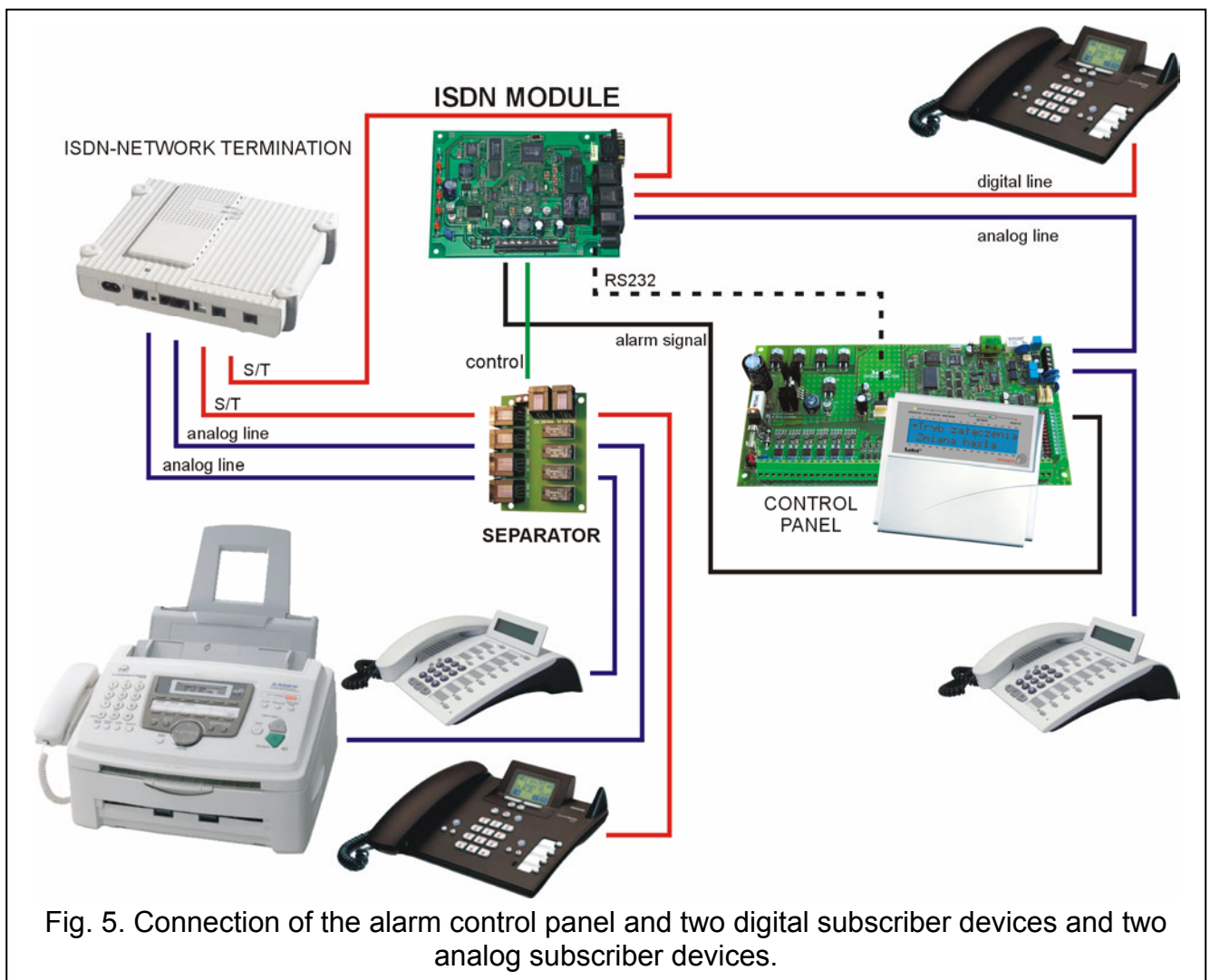

Fig. 5. Connection of the alarm control panel and two digital subscriber devices and two analog subscriber devices.

3.3.2 Preparation for work in point-to-point configuration

The point-to-point configuration is mainly offered to corporate customers. It enables just one device, usually a private exchange, to be connected to the NT network termination module. If it is required to use the ISDN module in this configuration, you should change the ISDN module settings, using AT commands, for operation in the point-to-point configuration (\$M0). In this case, the installation diagram will look as shown in Fig. 6.

It is assumed by default that another subscriber device, e.g. a private exchange is connected to the ISDN module ISDN-OUT socket (\$D1). For testing purposes or when the ISDN module is the only digital device connected to the NT network termination module, you should change the default settings related to presence of other devices to \$D0.

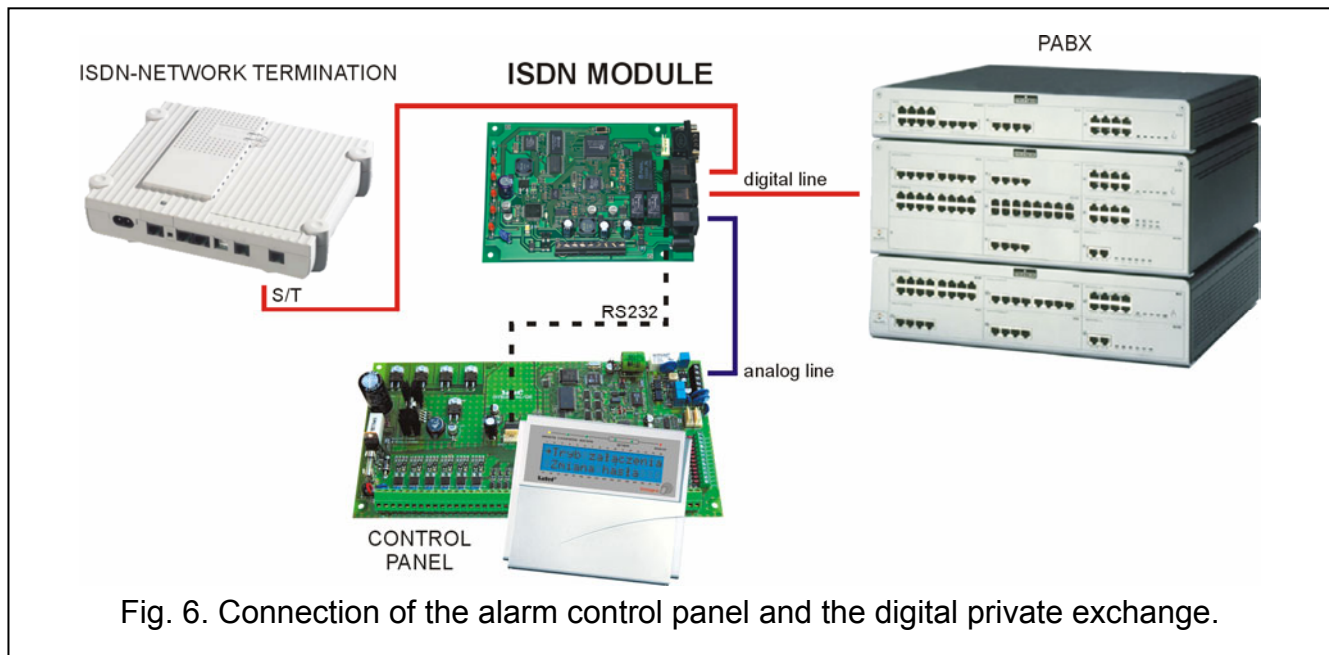

Fig. 6. Connection of the alarm control panel and the digital private exchange.

4. Equipment Factory Settings

- S0:000 - automatic answer to incoming calls OFF
- E1 - echo ON
- Q0 - display of result codes
- V1 - display of result codes as words
- W2 - CONNECT result code indicates speed of established connection
- X4 - busy status check / answer tone detection ON
- &D2 - functionality of DTR line
- \$A1 - automatic selection of TEI number in point-to-multipoint configuration
- \$C0 - cutoff of the other telephone lines is realized when all lines are busy, module alarm input is activated, and the control panel demands access to the telephone line
- \$D1 - in point-to-point configuration, another subscriber device is connected to the module ISDN-OUT socket
- \$L0 - ISDN line monitoring OFF
- \$M1 - point-to-multipoint configuration
- TEI:--- - no fixed TEI number

In most cases the factory settings will not need to be modified, as they ensure appropriate functionality of the equipment.

5. Modification of ISDN Module Settings with AT Commands

The RS-232 port enables the ISDN module to be connected to the computer, thus making it possible to modify the equipment settings by means of the AT commands (with *Terminal* type program – as is the case in the traditional modem). Having entered the command, confirm it by pressing the ENTER key.

The device settings are divided into 3 groups:

- ACTIVE SETTINGS – active settings, currently used by the ISDN module,
- USER PROFILE SETTINGS – user settings, defined by the user and stored in non-volatile memory,
- FACTORY SETTINGS – factory settings.

By entering the AT&V command, you can see all the setting profiles.

```

AT&V
ACTIVE SETTINGS:
S0:000 E1 Q0 U1 W2 X4 &D2 $A1 $C0 $D0 $L2 $M1 TEI:---
U110 9600

USER PROFILE SETTINGS:
S0:000 E1 Q0 U1 W2 X4 &D2 $A1 $C0 $D0 $L2 $M1 TEI:---
U110 9600

FACTORY SETTINGS:
S0:000 E1 Q0 U1 W2 X4 &D2 $A1 $C0 $D1 $L0 $M1 TEI:---
U110 9600

OK

```

Fig. 7. Window of the Hyper-Terminal program, showing the ISDN module settings.

After power-up, the user settings are loaded into the active profile. At the first start of the ISDN module, the active, user, and factory settings are identical. The active settings can be modified with the use of AT commands. For the modifications to be permanent, the new settings must be saved in the non-volatile memory (user profile) by means of the AT&W command. Loading the factory settings into the active profile is made possible by the AT&F command. In order to load the user settings into the active profile, enter the ATZ or ATZ0 command.

6. AT Commands Accepted by ISDN Module

The ISDN module accepts the following AT commands:

- A - answer incoming call
- B - select ISDN protocol:
 - B14 - V.110 at a rate of 4800 baud
 - B15 - V.110 at a rate of 9600 baud
- D - select number (max. 20 characters)

Example

```
ATD497 - select no. 497
```

- En - echo configuration
 - E0 - switch echo off
 - E1 - switch echo on

- H - hang up
- In - display equipment data
 I0 - display product code (1292 means DSS1)
 I1 - display equipment information (manufacturer, version)
- Qn - modification is not possible (default setting: Q0 - display result codes)
- Sn= - write to S registers
 S0 - number of rings after which the call is to be answered, min 0, max 255
- Examples:
- ATS0=5 - answer the incoming call automatically after 5 rings
 ATS0=0 - disable the function of automatic answer to the incoming calls
- Sn? - read contents of S registers
- Vn - modification is not possible (default setting: V1 - display result codes as words)
- Wn - modification is not possible (default setting: W2 - CONNECT result code indicates speed the connection is established with)
- Xn - modification is not possible (default setting: X4 - check of busy status and detection of answer tone are activated)
- Zx - restore given profile settings
 Z1 - restore factory settings
 Z, Z0- restore user settings saved in non-volatile memory
- &Dn - permanently set as &D2 and cannot be modified
- &F - restore factory settings
- &V - display settings for individual profiles
- &W - save the active settings in non-volatile memory as a new user profile
- &ZIn - save the MSN number (where n = 0 refers to analog connection, n = 1 connection in V.110 standard)
- Examples:
- AT&ZI0=123- entering this command makes the equipment receive ONLY the analog-type calls directed at no. MSN ending in the sequence 123, the sequence length being min. 1 and max. 20 digits
 AT&ZI0= - entering this command (without any MSN number) makes the equipment receive all the analog-type calls
- &ZI? - display entered MSN numbers
- \$An - selection of the mode to assign the TEI number in ISDN network
 \$A0 - non-automatic assignment of the TEI number (by default in point-to-point configuration)
 \$A1 - automatic selection of the TEI number (by default in point-to-multipoint configuration)
- \$Cn - configuration of function to realize cutoff of telephone lines
 \$C0 - cutoff of the other telephone lines is realized when all lines are busy, module alarm input is activated, and the control panel demands access to the telephone line
 \$C1 - cutoff of the other telephone lines is realized always when all lines are busy and the control panel demands access to the telephone line
 \$C2 - cutoff of the other lines is realized when alarm output is activated
- \$Dn - this option regards only the point-to-point configuration and defines whether the ISDN module is to interact with an additional subscriber device connected to the ISDN-OUT socket
 \$D0 - no devices connected to the ISDN-OUT output
 \$D1 - another subscriber device is connected to the ISDN-OUT output

- \$L** - configuration of the ISDN line detecting function
\$L0 - monitoring of ISDN line presence OFF
\$L1 - monitoring of ISDN line presence ON, which constantly checks the activity in physical layer
\$L2 - monitoring of ISDN line presence ON – the activity in physical layer checked every 30s
- \$Mn** - selection of ISDN network configuration
\$M0 - point-to-point configuration
\$M1 - point-to-multipoint configuration
- \$T=** - enters the TEI number if \$A0 option is selected, i.e. non-automatic assignment of the TEI number

Example:

AT\$T=0 - assignment of number TEI=0 to ISDN module

- \$T?** - displays the currently used TEI number

7. Technical data

Rated supply voltage	12V DC
Maximum current consumption	500mA
Interfaces:	digital interface BRI (2B+D) analog interface to connect analog subscriber equipment
Protocols:	DSS1 (Euro ISDN) V.110
Working temperature range:	+5° to +35°C

8. History of the manual updates

Described in the table below are changes as compared with the manual for the ISDN module with firmware in version v1.00.

DATE	PROGRAM VERSION	INTRODUCED CHANGES
2005-12	1.06	<ul style="list-style-type: none"> • Added information on work of the ISDN module in point-to-multipoint or point-to-point configuration (p. 2, 5 and 8). • Re-edited section 3 "Connecting the module" (p. 3-8). • Added drawing to illustrate connection of the RS-232 ports of control panel and ISDN module (p. 4). • Information on priority assignment to control panel outgoing connections has been moved to section 3.2 "Connecting the alarm control panel" and modified by adding the module operation in point-to-multipoint (p. 4) or point-to-point (p. 4) configuration. • Modified and supplemented information on ISDN separator (p. 6). • Modified and supplemented section 4 "Equipment factory settings" (p. 8). • Modified and supplemented section 5 "Modification of ISDN module settings with AT commands " (p. 9). • Modified and supplemented section 6 "AT commands accepted by ISDN module" (p. 9-11).

SATEL sp. z o.o.
ul. Schuberta 79
80-172 Gdańsk
POLAND
tel. + 48 58 320 94 00
info@satel.pl
www.satel.pl