

Alarm Control Panel

CA-5

Program Version 1.09

Satel 

GDAŃSK

USER MANUAL





WARNING

In order to avoid any operational problems with the control panel, it is recommended that you read carefully this manual before you start using the equipment.

Making any construction changes or unauthorized repairs is forbidden. This applies, in particular, to modification of assemblies and components. Maintenance or repair operations should be performed by authorized personnel (i.e. the installer or factory service).

The control panel can only work with **analog subscriber lines**. Connecting the telephone circuit directly to a digital network (e.g. ISDN) will result in damage to the equipment.

If the analog telephone network is to be replaced by the digital one, please consult the installer of your security system.

Pay special attention if the telephone line used by the control panel is frequently busy and/or failures are reported concerning the line and/or monitoring. Report such situations to the alarm system installer immediately.

CAUTION!

The alarm system is fitted with a battery which contains lead. After expiry of its service, the battery must not be thrown away, but disposed of as required by the existing regulations (European Union Directives 91/157/EEC and 93/86/EEC).

Latest EC declaration of conformity and product approval certificates can be downloaded from web site **www.satel.pl**



DEFINITIONS OF SOME TECHNICAL TERMS AS USED IN THIS MANUAL:

- **Service mode** – the control panel condition which permits calling of the service functions and programming of the security system parameters.
- **User function mode** – the control panel condition which permits performing the user code protected functions (which are described herein).

CONTENTS

1. TECHNICAL RELIABILITY OF THE SECURITY SYSTEM.....	2
2. ALARM SYSTEM OPERATING COSTS.....	2
3. GENERAL FEATURES	2
4. OPERATION	3
4.1 LED FUNCTIONS	4
4.2 STATUS OF CONTROL PANEL ARMED ZONES IN LCD KEYPAD	5
4.3 CONDITIONS SIGNALLED ACOUSTICALLY IN THE KEYPAD.....	5
4.4 EVENTS SIGNALLED ON THE OUT1 OUTPUT	6
4.5 USER ACCESS CODES.....	6
4.6 ARMED MODE OF THE CONTROL PANEL.....	7
4.6.1 FULL ARMED MODE.....	7
4.6.2 SILENT ARMED MODE.....	7
4.6.3 PARTIAL ARMED MODE WITH NO EXIT FROM THE SITE	7
4.7 ARMING [CODE][#]	7
4.8 QUICK ARMING [0][#]	8
4.9 DISARMING AND ALARM CLEARING [CODE][#]	8
4.10 REMOTE ARMING/DISARMING AND CLEARING ALARM	8
5. „HOLD DOWN” USER FUNCTIONS	9
5.1.1 LCD KEYPAD	9
5.2 ALARM MEMORY REVIEW [5].....	9
5.3 TROUBLE MEMORY REVIEW [6]	10
5.4 CURRENT TROUBLE CHECK-OUT [7]	10
5.4.1 DESCRIPTION OF SOME TROUBLE SIGNALING CAUSES.....	11
5.5 SWITCHING THE CHIME ON/OFF [8].....	11
5.6 FIRE ALARM [*]	11
5.7 AUXILIARY ALARM [0]	12
5.8 PANIC ALARM [#]	12
6. USER FUNCTIONS ACCESSIBLE WITH ACCESS CODE	12
6.1 START DOWNLOAD [CODE][*][0][#].....	13
6.2 CHANGE ACCESS CODE [CODE][*][1][#]	14
6.3 ADD USER [CODE][*][2][#].....	14
6.4 ERASE USER [CODE][*][3][#]	15
6.5 BYPASS ZONES [CODE][*][4][#]	15
6.6 ARM SILENT [CODE][*][5][#].....	16
6.7 SET TIME [CODE][*][6][#]	16
6.8 MONO OUTPUTS [CODE][*][7][#]	18
6.9 BI OUTPUTS [CODE][*][8][#]	18
6.10 POWER SUPPLY RESET [CODE][*][9][#]	18
6.11 EVENTS [FUNCTION 10 – ONLY LCD KEYPAD].....	18
6.12 TESTING OUTPUTS AND LED INDICATORS [CODE][*][11][#].....	19
6.13 SERVICE ACCESS [CODE][*][12][#]	19
7. HISTORY OF MANUAL UPDATES	20

1. TECHNICAL RELIABILITY OF THE SECURITY SYSTEM

The security system is built of technical devices, the reliability of which is vital for effectiveness of the site protection. The security system elements are exposed to a variety of outside factors, including the weather conditions (outside sirens), lightning (overhead telephone lines, power lines, outside sirens), mechanical damage (keypads, detectors. etc.). Maintaining a high level of the security system reliability is only possible by current control of the functioning of particular devices.

The control panel is equipped with a number of safeguards and auto diagnostic functions intended for testing the system reliability. The control panel signals trouble detection by switching on the TROUBLE LED on the keypad. **Such a situation requires an immediate response and, if necessary, consultation with the installer.**

It is necessary to periodically test the security system functioning. Make sure that the control panel reacts to violation of individual detectors, that their field of vision is not blocked, that there is a reaction to the opening of protected doors and windows, and that the functioning of sirens and telephone monitoring is correct.

The installer should provide specific instructions on how the system should be tested. It is recommended that periodical surveys be carried out by the installer, as requested by the user.

The user, in his own interest, should anticipate unexpected alarm conditions and plan adequate procedures. It is vital to be able to verify the alarm, to determine its source based on the keypad information, and to take appropriate measures, e.g. to organize evacuation.

2. ALARM SYSTEM OPERATING COSTS

The main task of the control panel is signaling and efficient reporting of alarm situations and, as far as the monitoring function is concerned, keeping the monitoring station informed about the protected facility status. Performance of these functions is to a large extent based on the use of a telephone line, which entails generating certain costs. Generally, the level of costs incurred by the alarm system owner depends on the amount of information the control panel has to transfer to the monitoring station. A failure of the telephone links, as well as incorrect programming of the control panel, may considerably increase these costs. Such a situation is usually related to an excessive number of connections made.

The installer can adjust functioning of the alarm system to the specific conditions and the type of protected site, however it is the user who should decide if his or her priority is transferring information at any price, or, if some technical problems occur, the control panel is allowed to skip some events, the reception of which has not been confirmed by the monitoring station.

3. GENERAL FEATURES

The CA-5 alarm control panel is an advanced, microprocessor based device designed for burglary and panic alarm systems. It is characterized by simplicity of operation, legibility of information for the user, and a high operational reliability. It has been fitted with a telephone communicator (dialer) which enables the security system to operate together with a monitoring station.

The control panel is intended for a variety of sites, including apartments, detached houses, warehouses, stores, kiosks, etc.

4. OPERATION

This manual contains description of operating the CA-5 alarm control panel by means of the keypad.

Operating the security system consists basically in arming / disarming the system (switching the supervision on/off), and in adequate reaction to the information indicated by the control panel.

By means of the control panel keypad, it is possible to trigger special alarms (PANIC, FIRE, HELP), to bypass the zones, to establish communication with the service computer, and also to control external electrical equipment, such as: electromagnetic lock, fan, lighting, etc.

The keypad provides information on the security system status by means of 10 light emitting diodes (LED) and audible signals.

The LCD keypad provides information on the alarm system status by means of a liquid-crystal display (2x16 characters), three light emitting diodes (LEDs), as well as audible signals.

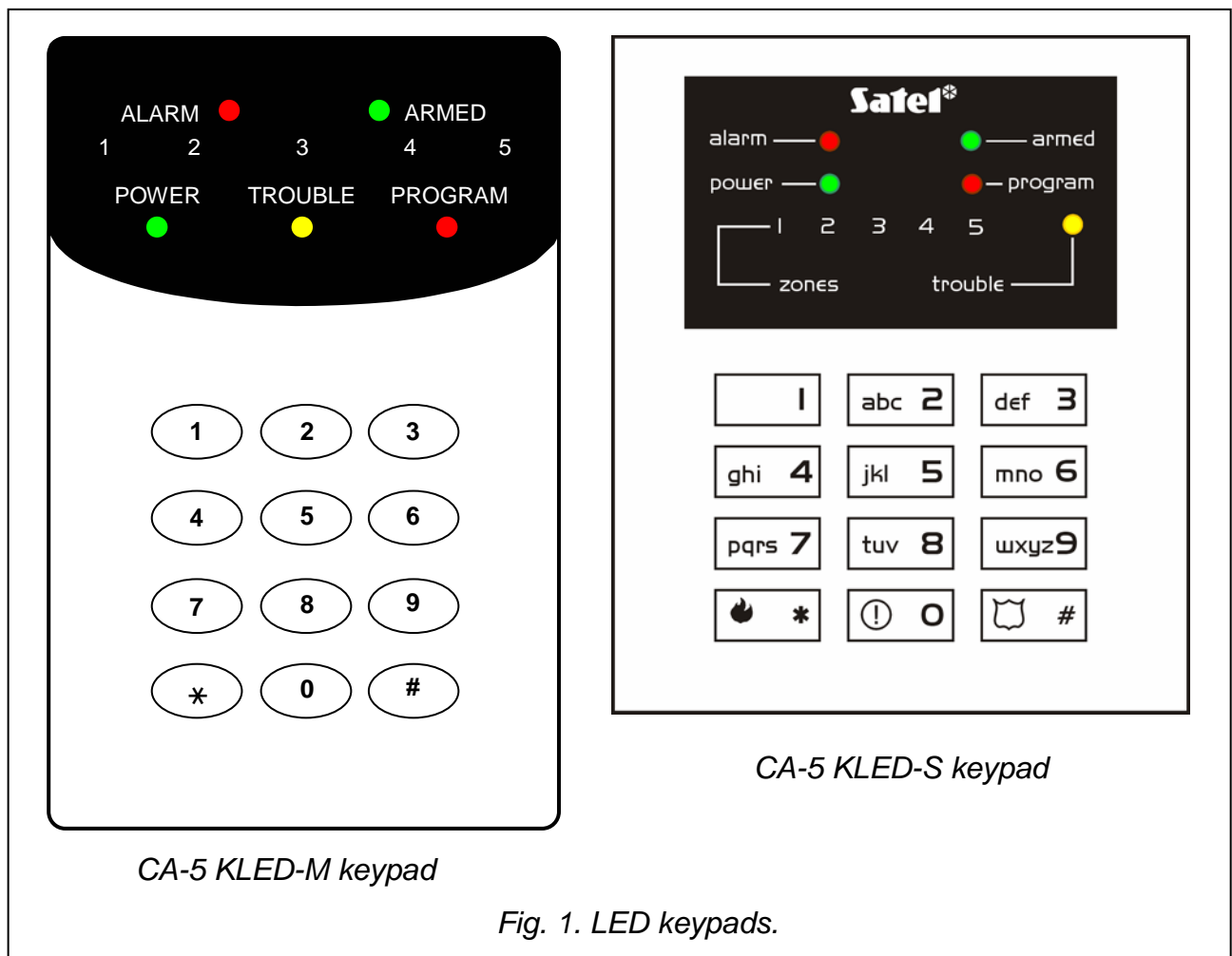

The LCD keypads are available in two versions i.e. (CA-5 KLCD-L and CA-5 KLCD-S) that differ in their overall dimensions and the display size.

The backlighting of keypad and display can be permanent or switched on automatically by pressing a key, or, alternatively, by violation of any control panel zone when in armed mode – the manner of backlight operation should be determined by the installer.

The letters on number keys help the user memorize the code by associating it with a particular word (e.g. the „[2][6][2][7][2]” code corresponds to the word „COBRA”).

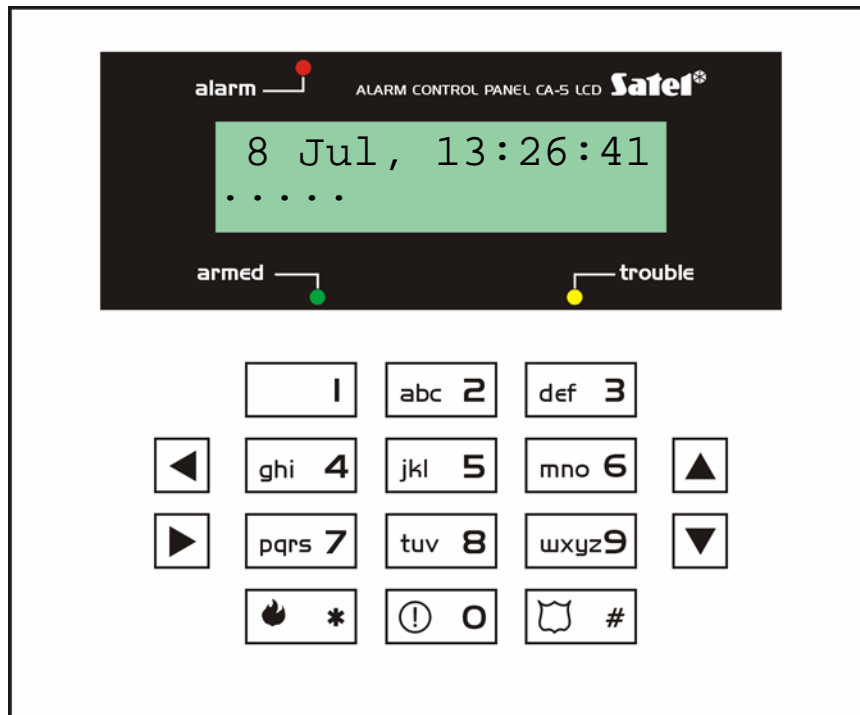

Fig. 2. CA-5 LCD keypad

Note: Access to all functions of the control panel in version 1.09 is made possible by: LCD keypads in program version 1.07 and later, CA-5 KLED-M keypads in version 1.2 and later, and CA-5 KLED-S keypads in version 1.1 and later.

4.1 LED FUNCTIONS

Some of the LEDs are only mounted in the LED keypads, their tasks in the LCD keypads being taken over by LCD display.

- **ALARM** (red) – signals an alarm condition.
- **ARMED** (green) – indicates the system status:
 - blinking (with the ALARM diode off) - countdown of the exit delay time,
 - on - the zone is armed (optionally, the LED can be extinguished by the control panel after elapse of 3 minutes from arming).
- **1+5** – the status of control panel supervision zones (red):
 - off - the zone is free (not violated)
 - on - the zone is violated
 - on with short extinguishing every 2 seconds - the zone tamper circuit is violated (memory of 2EOL zone tamper alarm)
 - blinking 0.5s/0.5s - the zone caused alarm (alarm memory)
 - blinking 0.25s/0.25s - the zone has been violated or caused alarm as the first one (counting from the moment of ending the exit delay countdown after arming)
 - blinking every 2 seconds - the zone tamper circuit has caused an alarm (for the 2EOL zone)
 - slow blinking (1s/1s) - the zone is bypassed

Notes:

- Depending on the options set, the memory of alarm from zone is active until disarming and alarm clearing, or until reviewing alarm log after previously disarming the system, or until rearming the system.

- *If, when the control panel is in armed mode, an ENTRY/EXIT or DELAYED zone will be violated as the first one, and then another zone will set off alarm, then the memory of the first alarm will be assigned to the zone which was violated first.*
- *If, after violation of an ENTRY/EXIT or DELAYED zone, the system will be disarmed without setting off alarm, then the memory of the first alarm (violation) will be automatically cleared.*
- **POWER** (green) – indicates the control panel power supply status:
 - on - power supply and battery OK
 - blinking - low battery
 - off - no mains power
- **TROUBLE** (yellow) – blinks when the control panel detects a technical problem or a monitoring problem. The LED will go out when the trouble cause is removed or after the function of checking the current troubles is performed (key 7 function).
- **PROGRAM** (red) – indicates the control panel operation in programming mode:
 - on – service mode (additionally, a short beep every 3 seconds) – pressing successively the [0][#] keys will result in return to the normal operation mode
 - slowly blinking – user function mode
 - fast blinking – programming of a function has been called (service or user); the alarm or trouble viewing function has been activated (HOLD DOWN user function).

4.2 STATUS OF CONTROL PANEL ARMED ZONES IN LCD KEYPAD

The first five characters (counting from the left) in the LCD display lower line indicate the state of detectors attached to the control panel armed zones. Stated below are the symbols which may be displayed there, as well as their respective meanings:

- - the zone is free (not violated)
- - the zone is violated
- - 2EOL zone tamper violated
- a - the zone caused an alarm condition (alarm memory)
- A - the zone has been violated or caused alarm as the first one (counting from the moment of ending the exit delay countdown after arming – see notes in the section on LED FUNCTIONS)
- s - zone triggered the tamper alarm (memory of 2EOL zone tamper alarm)
- S - tamper alarm caused as the first one (for 2EOL zone)
- b - the zone is bypassed

4.3 CONDITIONS SIGNALLED ACOUSTICALLY IN THE KEYPAD

The signals generated to confirm the operation on the keypad:

- **one short** – confirmation of pressing a key; activation of the review function in the keypad (HOLD DOWN: 5, 6, 7)
- **three short** - confirmation of entering the mode of user functions programming; deactivation of the chime signaling in the keypad (key 8), reset of the DURESS ALARM output activity,
- **one long** (lasting approx. 1.5s) - refusal to arm due to violation of some zones which are not supposed to be violated at the moment of arming,
- **two long** - a wrong access code, canceling a function or incorrect data for a function,

- **three long** - an attempt to arm the system when the control panel is not ready for the job (violated zones with the activated option of „*priority*” - see „Arming”), refusal to enter the function,
- **four short, one long** – arming/disarming, entering the service mode, successful completion of function programming, activating the chime signaling in the keypad.
- **six short** – partial arming (there are some zones bypassed).

System events signaling:

- **continuous signal** – alarm,
- **intermittent signal** - fire alarm,
- **one short signal every 3 seconds** - entry time countdown; service mode (with the PROGRAMMING LED on),
- **one long signal every 3 seconds** - exit delay countdown,
- **five short signals** - violation of the "CHIME" type zone.

Which events are to be signaled acoustically should be determined by the installer.

4.4 EVENTS SIGNALLED ON THE OUT1 OUTPUT

The installer may activate the signaling of arming/disarming and alarm clearing on the OUT1 output. If this output controls the siren operation, it will generate short sounds (in much the same way as in the car alarm systems). The signals have the following meanings :

- **one short sound** – arming,
- **two short sounds** – disarming,
- **four short sounds** – clearing the alarm or disarming and clearing the alarm.

Additionally, the OUT1 output signals the typical situations for the security system:

- **continuous signal** – burglary alarm,
- **intermittent signal 1s/1s** – fire alarm.

The installer may select an identical manner of signaling for the fire alarm as for the burglary alarm (i.e. the continuous signal).

4.5 USER ACCESS CODES

For everyday operation of the system it is necessary to know the user access code (**the access code** is a sequence of **4 to 8 digits** within the range of 0-9).

To enter the access code in the control panel, press the corresponding keys on the keypad in the order of the code digits and finish the full sequence by pressing the [#] or [*] keys (as may be required). The control panel comes with the following factory settings:

master user access code: **1234;**
service code: **12345.**

By using the master user code you can program **5 additional user access codes**, or to delete them if they were programmed before.

The installer can assign specific authority levels to some of the access codes to distinguish them from the other user codes:

- Access code No. 4 – **action under duress** (disarming or alarm clearing by means of this code results in sending a special code to the monitoring station, and activating the DURESS ALARM output)
 - access code cannot be changed with the user function 1;
 - the code does not reset activity of the DURESS ALARM output.

- Access code No. 5 - **does not disarm for other users** – permits disarming only when the same access code was used for arming the system, which makes it possible to control (block) access to the site for the user who has such an access code at his disposal.

The service code provides access to some of the user functions (besides creating and deleting the users, and arming or disarming the system).

4.6 ARMED MODE OF THE CONTROL PANEL

In order to adjust the security system to various situations, the CA-5 control panel offers several armed modes:

4.6.1 Full armed mode

The operating mode when detectors connected to the control panel control the protected site and violation of the protected areas is signaled by the control panel with any available means (monitoring, sirens, keypad).

4.6.2 Silent armed mode

The supervision mode during which the alarms are transmitted to the monitoring station, signaled in the keypad, and on the KEYPAD ALARM type of output.

4.6.3 Partial armed mode with no exit from the site

The armed mode with automatic bypassing of the zones (detectors) assigned by the installer. If, after arming the system, the user has not left the site and has not violated the entry/exit monitoring line during the exit delay, the selected zones of the control panel will be automatically bypassed, and activation of the detectors connected to those zones will trigger no alarm.

4.7 ARMING

[CODE][#]

The arming is only possible when the system is signaling no alarm and it is not in the armed mode: the ALARM and ARMED LEDs are off.

In order to arm the system, enter the user access code and confirm it with the [#] key. If you made a mistake when entering the access code, press the [*] key and re-enter the code. The access codes should be entered very carefully. Three consecutive mistakes may trigger the alarm recorded in the events log as the „3 wrong codes alarm”.

If the code is entered correctly and arming is possible, the control panel will confirm the entry with four short beeps followed by a long one and will get armed. In case the installer has pre-programmed the „exit delay”, the ARMED LED will start blinking to indicate beginning of that time countdown, and arming will take place when the countdown is over. The LCD keypad will display information about exit time delay.

The installer determines the length of the exit delay and the way the audible signaling works.

EXAMPLE: Arming with the user access code: 39763.

press in turn: [3][9][7][6][3] [#]

The control panel may fail to arm the system if:

- the panel is not ready for arming the system: **there are zones indicated by the installer which must not be violated while the system is being armed** („priority” option) and one of them is being violated – the panel signals this state with three long beeps and displaying the names of violated zones on LCD keypad.

In such a situation, you should wait until all the zones are ready (in the LED keypad the LEDs 1÷5 will go out; in the LCD keypad – symbols of zone violation) and then arm the system again (enter the access code). If one of the zones remains all the time violated (in the LED keypad one of the LEDs 1÷5 is always on, in the LCD keypad the symbol of

zone violation is displayed - it may be caused e.g. by the detector failure), the armed mode can be activated after bypassing the given zone (using the function 4);

- the access code is incorrect – this situation is signaled with two long beeps.
- at least one output in the system performs the DURESS ALARM function and is on (active). Using the code which does not carry out the „action under duress” function will reset the a.m. output activity (three short beeps) without arming the system; the system will only be armed on using any code again.

4.8 QUICK ARMING

[0][#]

Quick arming without using any access code is possible by consecutive pressing of two keypad keys:

EXAMPLE: [0][#] - arming

The control panel cannot arm the system when:

- an alarm condition is signaled by the panel (the ALARM LED is blinking);
- the panel is not ready to arm the system - which is signaled by the panel with three long beeps (see description in the previous paragraph of this manual);
- the function is disabled by the installer – this situation will be signaled with two long beeps.

4.9 DISARMING AND ALARM CLEARING

[CODE][#]

If the panel is armed (the ARMED LED is on or blinking) and/or it signals an alarm (the ALARM LED is on or blinking), entering the user access code and confirming it with the [#] or [*] key will disarm the system and clear the alarm. If, while entering the access code, you make a mistake, press the [*] key and re-enter the code. The control panel will confirm acceptance of the command by four short beeps and a long one, and by extinguishing the ARMED LED and/or ALARM LED (if it was on).

The service code can only clear the tamper alarm or the keyboard alarm when the ARMED LED is off (the control panel is disarmed).

The panel will not disarm the system or clear the alarm when the access code is wrong.

The user access code No. 5 will not clear the alarm in the armed mode if it has been assigned a special authority level, and the system was armed by another user.

Refusal to clear the alarm is signaled with three long beeps.

4.10 REMOTE ARMING/DISARMING AND CLEARING ALARM

The installer may install in the security system a special remotely controlled radio line, or a special button, designed for quick arming/disarming of the system or clearing of alarm. For this purpose, one of the control panel programmable zones is used. The system will be always armed in this mode (by violation of the zone), irrespective of the status (violation) of the other zones of the control panel.

The zone can work in two modes:

- bistable - the control panel is armed when the zone is violated, and it is disarmed when the zone is in its normal mode (not violated),
- monostable – each violation of the zone will change the control panel state to the opposite one (i.e. it will arm the system when the panel was disarmed, and it will disarm the system and clear the alarm if the panel was armed (and alarming). In the monostable mode, the installer may restrict the zone operation to arming only, while disarming and alarm clearing will require the user access code.

To facilitate remote control of the panel, the installer may activate the signaling of arming/disarming on the OUT1 alarm output (see: Events Signaled on the OUT1 Output).

5. „HOLD DOWN” USER FUNCTIONS

The functions are available to every user of the protected site (without using the access code). They are activated by **holding down** the function key until audible signal sounds in the keypad. The first three functions refer to viewing the alarms and troubles. Depending on the keypad type the viewing is done in different ways.

5.1.1 LCD keypad

To start the viewing, call the function and press any of the arrow keys - information on the most recent alarm condition, referring to selected function, will be displayed. The ([▲],[▼]) arrow keys on the right side of the keypad allow the user to scroll through the list of events provided by the alarm control panel. The events are displayed chronologically ([▲] - earlier ones, [▼] - later ones).

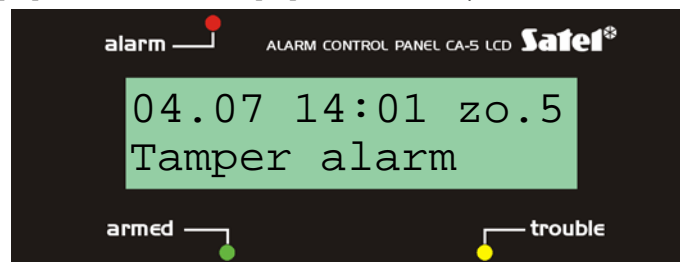

Fig. 3. Example of events description.

The event description contains:

date	- day and month
time of event	- hour and minutes
source code (if possible)	- <i>kpd.</i> keypad
	- <i>zo.n</i> , n=1,2,...,5 - zone number,
	- <i>us.n</i> , n=1,2,...,5 - ordinary user number
	n=6 - master user
	n=7 - service
name of event	- description in words

The ([◀],[▶]) arrow keys on the left side of the keypad make it possible to display the user name (default one or entered into the control panel memory by the installer using the DLOAD10 computer program). Pressing the same key again will restore the previous mode of event information display.

Pressing the [*] key terminates the viewing function.

The method of reading information from the LED keypad is described together with particular functions.

5.2 ALARM MEMORY REVIEW

[5]

Holding down the [5] key (until a single beep is heard) will display information on the most recent alarm condition. The PROGRAM LED will be blinking, and the LEDs 1-5 will indicate the cause of the alarm. Pressing any key (except for the [*] key, which gives you the option to quit the memory log review immediately) displays the previous alarm conditions, up to the earliest item recorded:

- **zone alarms:** one of the LEDs 1 to 5 is always lit up (burglary, panic, fire, tamper, and other alarms, depending on how the zone functions have been set up by the installer),

- **keypad alarms:** one of the LEDs is off, and the other LEDs 1 to 5 are on, the meaning of the extinguished diode being as follows:

LED No	ALARM DESCRIPTION
1	Fire alarm , keypad
2	Panic alarm , keypad
3	Auxiliary alarm , keypad
4	3 wrong access codes alarm
5	Keypad tamper alarm (short-circuiting of bus wires, cutting off of keypad)

5.3 TROUBLE MEMORY REVIEW

[6]

This function allows the panel user to review the detailed information on the system trouble conditions from the panel memory log.

On pressing and holding down the [6] key (until you hear a single beep), the PROGRAM LED will start blinking, and the LEDs from 1 to 5 will indicate the type of trouble according to the list contained in the description of the CURRENT TROUBLE CHECK-OUT function. The list of detectable troubles consists of two sets of five items each. Troubles relating to the first set are indicated by the number of a lit up LED, whereas troubles relating to the second set are indicated by the number of an extinguished LED (one of five).

The previous (earlier) troubles are available for readout by consecutively pressing any key of the keypad, except for the [*] key which cancels the trouble memory review function.

5.4 CURRENT TROUBLE CHECK-OUT

[7]

When the control panel signals a trouble detection (the TROUBLE LED is blinking), holding down the [7] key (until you hear a single beep) will activate the Current Trouble Check-out Function. On activating the function, the PROGRAM LED will start blinking, and the LEDs 1 to 5 will indicate any possible troubles from the first set (list of troubles as per the table). Pressing any key (except for the [*] key) will change the set of displayed troubles to the other one, which will be signaled by two short beeps. Consecutive pressing of any key will display information, alternately, on the first set of troubles and on the second one. Pressing the [*] key will quit the function.

The meaning of the LEDs is as follows:

LED No.	FIRST SET OF TROUBLES
1	230V AC power supply loss
2	Battery trouble (or F1 fuse)
3	OUT1 output trouble (F2 fuse)
4	Power supply outputs trouble (F3 fuse)
5	Clock loss
	SECOND SET OF TROUBLES
1	No voltage on telephone line
2	Problem with access to settings memory
3	Wrong communication codes (connections from computer blocked for 30 minutes by the panel)
4	Monitoring trouble
5	Dialing error

Note: During the **trouble memory review**, the extinguished LED No. 3 (a second set trouble) means „Unsuccessful DWNL (downloading)”. The meaning described in the table refers to the current trouble check-out only.

5.4.1 Description of some trouble signaling causes

230V AC power supply loss - the control panel is fitted with a backup power supply to enable a limited time operation without the mains supply; if the AC loss is indicated despite the electrical installation being OK, you should call the service.

Battery trouble - means that the battery voltage is too low (lower than 12V under load). This condition may hold for several hours after AC supply loss (or after connecting a discharged battery). The battery charging time depends on its capacitance (the battery is charged with direct current of approx. 350mA, the time necessary for testing the battery status is about 12 minutes). This signaling may also indicate blowing of the F1 fuse.

OUT1 output trouble - no load (e.g.: the siren wires cut off, the F2 fuse blown) or overload (installation short-circuiting) – usually requires intervention of the service personnel.

Power supply outputs trouble - information on the installation fault (F3 fuse), requires intervention of the service personnel (it can be only displayed during the trouble memory review).

Clock loss - occurs on disconnecting the power supply and restarting the control panel; the clock and date should be set with the user function 6.

No voltage on telephone line - means cut-off of the telephone line; it may be also caused by lifting the handset of the telephone connected to the same line for longer than the time specified by the installer.

Problems with access to settings memory – may occur when the RESET pins on the control panel main board are shorted. If the pins are open, and connecting the power off and on does not clear the trouble signaling, intervention of the service personnel is necessary.

Wrong communication codes – means that during three consecutive communication sessions with the computer the control panel hanged up after reading a wrong communication code three times – in such a case, the panel suspends communication with the computer for 30 minutes (upon answering a call it sends to the computer a message that the connection capability is disabled and „hangs up”).

Monitoring trouble - this message indicates multiple occupancy of the line, when the monitoring station fails to go "off hook", does not send the handshake, or the acknowledgement signal after receiving the codes. If this signaling persists, the monitoring is ineffective and requires intervention of the service personnel or the technicians from monitoring station.

Dialing error - information on the cause of an unsuccessful telephone connection (lack of the dialing tone after the handset is lifted, or presence of an intermittent signal instead of the continuous one). The signaling of trouble will remain on until next successful telephone connection.

Depending on the programmed options, the current trouble memory will be deleted on clearing the cause of trouble, or only after running the above-mentioned current trouble checkout function.

5.5 SWITCHING THE CHIME ON/OFF

[8]

This function (holding down the [8] key) makes it possible to switch on/off the chime signal (signaling the violation of selected zones when the control panel is disarmed) from the keypad. Three short beeps in the keypad confirm switching off the chime signaling function, whereas four short beeps and a long one mean that the signaling is on.

The installer specifies which zones will generate the chime signal.

5.6 FIRE ALARM

[*]

This function makes it possible to trigger the fire alarm from the keypad. The control panel activates signaling on the OUT1 output in the keypad and sends an appropriate code to the monitoring station. The function can be disabled by the installer.

5.7 AUXILIARY ALARM

[0]

The meaning of this alarm is specified depending on the needs. The function may transmit information on the auxiliary alarm to the monitoring station (it may be, for example, a call for medical assistance, as it was adopted in the Contact ID monitoring format).

The function may be disabled by the installer.

5.8 PANIC ALARM

[#]

This function makes it possible to trigger the panic alarm from the keypad. The control panel activates signaling on the OUT1 output in the keypad and sends an appropriate code to the monitoring station. The function can be disabled by the installer or limited to the keypad and monitoring only (the SILENT panic alarm).

6. USER FUNCTIONS ACCESSIBLE WITH ACCESS CODE

If the control panel is not armed and is signaling no alarm, the users can access several functions useful in everyday operation of the security system.

The user functions described in this section are activated by entering the **user access code** and confirming it with the [*] key (not the [#] key as is the case when arming the system).

LED keypad

The panel confirms entering the user function mode by the slowly blinking PROGRAM LED. Next, press the key with the number of selected function and then the [#] key.

LCD keypad

The panel confirms entering the user functions mode with three short beeps and displays the two first names out of the currently accessible user functions.

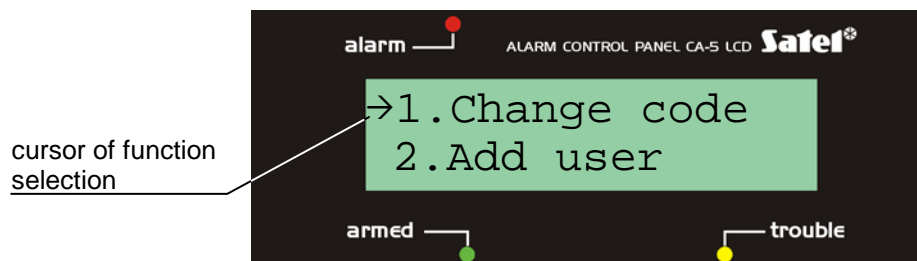

Fig. 4 Fragment of user functions menu - example.

To reach the required menu function, press the key with selected function number, or, alternatively, move the „→” selection cursor up or down using the [▲], [▼] keys so that it indicates the suitable function. The function is activated upon pressing the [#] or [▶] keys.

When activated, some functions require that data be entered or selection be made; if this is the case, the control panel waits for the user to take action (a corresponding message will appear on the LCD display; the PROGRAM LED will be blinking fast in the LED keypad).

USER FUNCTIONS MENU:

FUNCTION NR	FUNCTION NAME
0	Start DWNL (starts panel programming by the phone from service computer)
1	Change access code
2	Add user (adds new user code)
3	Erase user (deletes user code)
4	Bypass zones
5	Arm silent (activates silent armed mode)
6	Set time (programs panel clock)
7	MONO outputs (MONO SWITCH output on)
8	BI outputs (BI SWITCH output on/off)
9	Power supply RESET on RESETTABLE POWER outputs type
10	Events (only in LCD keypad)
11	Outputs & LEDs test
12	Service access

Notes:

- The functions 2, 3 and 12 are available to the master user only, while the functions 0, 10 and 11 - to the master user and the service.
- Pressing the [*] key at any time makes the control panel quit the user function mode.
- Having performed the function (or having refused to perform it), the control panel always quits the user function mode. To carry out a next function you must re-enter the access code, confirm it with the [*] key, select the function number and confirm it by pressing the [#] key.
- Refusal to perform the function is signaled with three long beeps (e.g. after calling the function 2, when all the access codes are already entered).

6.1 START DOWNLOAD**[CODE][*][0][#]**

The function connects the control panel by telephone with the service computer for remote programming of the security system parameters and downloading the event memory log. The function can be called by the master user and the service.

The computer program makes available to the computer operator a keypad working simultaneously with the real keypads installed in the system, and provides detailed monitoring of the system, including the status of its zones and outputs. The knowledge of the users' access codes makes it possible to use the computer pad in the same way as any additional system keypad (most of the user functions are available).

On activating the function, the panel engages the telephone line and connects to the service computer. During the data exchange the telephone line will be busy. The service can temporarily free the telephone line by suspending the downloading, and then calling the control panel again to continue the data exchange. The installer should make the users aware of it so that they will not answer the incoming calls to allow re-establishing of the connection and correct completion of the transmission.

The function is called in the same way as the user function 5.

Connection between the control panel and the computer (after the panel is appropriately programmed) can be initialized from outside by the computer calling the control panel, and also can be effected by the installer in local mode using the corresponding service function.

The meaning of audible signals generated on activating the function:

- three long beeps mean that the line is engaged by monitoring – wait and then repeat the function calling attempt,
- two long beeps mean lack of the programmed computer number or unavailability of the function to the given user.

Notes:

- The function enables connection between the panel and the computer, when the option to establish communication from outside (from the computer) is blocked.
- Initiation of the programming from the outside may be useful e.g. when the user is often absent from the site, and there is an urgent need for service intervention or remote testing of the security system .
- Programming the computer telephone number (when the function initiating the programming from the outside is available) is an extra safeguard against the panel being accessed by any computer except the service one (in case unauthorized persons know the communication access codes).
- It is possible to block the service computer access to the control panel for the time of armed mode.

6.2 CHANGE ACCESS CODE

[CODE][*][1][#]

The function permits changing the access code of the user who has activated the function. It is only unavailable to the user 4, if a special „duress action” authority level has been selected for him. Such an access code can only be changed by the master user by deleting and re-entering it.

Having called the function, enter the new access code and press the [#] key.

In the LED keypad the number of the lit up LED (1-5) indicates which access code is being changed. When changing the master code or the service code none of the LEDs 1-5 is on.

EXAMPLE: changing the access code from 1234 to 7890.

[1234] [*] - calling the "user function" mode, confirmed with three short beeps and in the LED keypad additionally with slow blinking of the PROGRAM LED,

[1][#] - calling the "change code" function, confirmed with two short beeps and in the LED keypad additionally with fast blinking of the PROGRAM LED (in the LCD keypad this function may be called using [▶] or [#] keys),

[78[90][#] - entering the digits of a new code and accepting it, confirmed with four short beeps and a long one – return of the control panel to the normal operating mode.

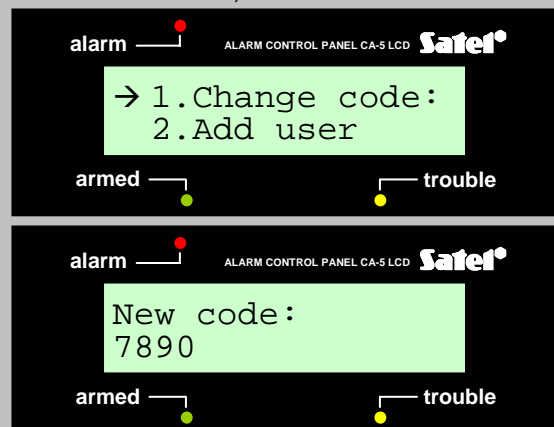

6.3 ADD USER

[CODE][*][2][#]

This function permits adding new users of the system (i.e. the access codes capable of controlling the panel operation). It is only available to the Master code user.

As new users are added to the system, they are automatically assigned consecutive numbers by the panel. If the function is called after the number of entered users has reached five, the control panel will generate three long beeps and will quit the *user function* mode. If any of the

codes have been deleted by means of the function 3, the control panel will allow new user access codes to be entered in their place.

After calling the function, the control panel waits for entering the new user access code (4 to 8 digits). Afterwards, the [#] key should be pressed.

In the LED keypad the number of the user code being programmed is indicated by blinking of one of the LEDs 1 to 5. In the LCD keypad the number of the user code is displayed.

EXAMPLE: entering the new user access code = 4938
(master user access code = 7890).

[7890] [*] - calling the "user function" mode, confirmed with three short beeps and in the LED keypad additionally with slow blinking of the PROGRAM LED,

[2][#] - calling the "enter new user access code" function, confirmed with two short beeps, and in the LED keypad additionally with lighting up of one of LEDs 1-5 and fast blinking of the PROGRAM LED (in the LCD keypad this function may be called with arrow keys),

[493827][#] - entering the new code digits and accepting it, confirmed with four short beeps and a long one – return of the control panel to the normal operating mode.

6.4 ERASE USER

[CODE][*][3][#]

The purpose of this function is to delete the access codes of existing users if the contents of their code is lost, or to revoke the current users' authority to operate the security system. The function is only available to the Master user.

After calling the function, the control panel will light up the LEDs with the numbers of current user codes, and will display their numbers in the LCD keypad. Pressing the key with the digit corresponding to the number of existing access code will extinguish the given LED (digit). In order to delete selected access codes, it is necessary to extinguish their corresponding LEDs (digits) and accept the selection with the [#] key. The LEDs (digits) indicate which access codes will remain in the system after quitting the function.

EXAMPLE: deleting the third and fifth user's access codes (Master user code = 7890).

[7890] [*] - calling the "user function" mode, confirmed with three short beeps and in the LED keypad additionally slow blinking of the PROGRAM LED,

[3][#] calling the "erase user" function, confirmed with two short beeps, and in the LED keypad additionally with lighting up of LEDs with the numbers of existing codes (e.g. 1,2,3,4,5) and with fast blinking of the PROGRAM LED (in the LCD keypad this function may be called using arrow keys),

[3][5] - indicating the numbers of deleted access codes – confirmed in the LED keypad by extinguishing of the LEDs with numbers 3 and 5 (the LEDs 1, 2 and 4 are still lit up), and in the LCD keypad by disappearing of digits 3 and 5 from the display (digits 1, 2 and 4 are still on),

[#] - deleting the selected access codes; four short beeps and a long one signal end of the function.



6.5 BYPASS ZONES

[CODE][*][4][#]

The function enables bypassing of the zones in order to arm a part of the system or to bypass malfunctioning detectors in the armed mode.

After calling the function, press the keys with numbers corresponding to the numbers of zones to be bypassed (the LEDs or digits corresponding to the selected zones will on) and confirm the selection with the [#] key.

After bypassing the zones and quitting the *user function* mode in the LED keypad, the corresponding LEDs start slowly blinking, in the LCD keypad letters "b" will appear on the display in the fields corresponding to the bypassed zones. The zones will remain bypassed until the next

disarming or their manual unbypassing with the same function. The unbypassing consists in extinguishing the LEDs (digits) which correspond to the bypassed zones. Bypassing/unbypassing a zone generates an event saved in the control panel memory.

Upon arming, the indication of bypassed zones is switched off.

Bypassing the Arm/Disarm type zones makes impossible the remote arming/disarming of the system, as well as the alarm clearing. This operation must then be performed by entering the access code from the keypad.

EXAMPLE: bypassing the zones 3 and 4 (user access code = 12321).

[12321] [*] - calling the "user function" mode, confirmed with three short beeps and in the LED keypad additionally with slow blinking of the PROGRAM LED,

[4] [#] - calling the "bypass zones" function, confirmed with two short beeps (in the LCD keypad this function may be called using arrow keys),

[3][4] - selecting the numbers of zones to be bypassed – in the LED keypad the LEDs 3 and 4 will light up, in the LCD keypad digit 3 and 4 will be displayed,

[#] - accepting the entered data - four short beeps and a long one signal end of the function.

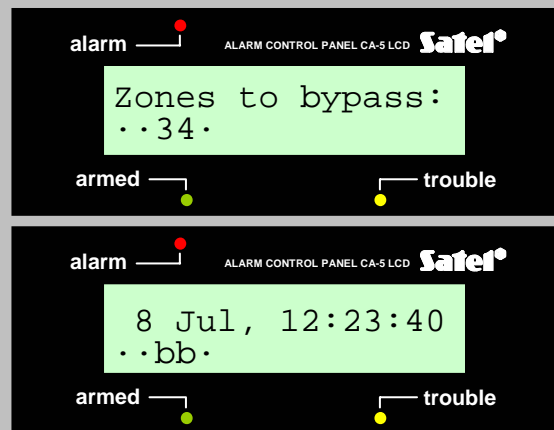

Note: The 24h zones (which are on duty, whether the system is armed or not) can only be bypassed by means of the service code.

6.6 ARM SILENT

[CODE][*][5][#]

In the silent armed mode, the alarms are not signaled on the OUT1 output and on the output programmed as BURGLARY ALARM. They are only signaled in the keypad and by sending a message to the monitoring station. The function is unavailable for service.

EXAMPLE: activating the silent armed mode (user code = 1230).

[1230] [*] - calling the "user function" mode, confirmed with three short beeps and in the LED keypad additionally slow blinking of the PROGRAM LED,

[5] [#] - activating the silent armed mode - four short beeps and a long one signal the end of the function (in the LCD keypad this function may be called using arrow keys).

Note: If a zone monitored during armed mode activation is violated on calling the function, the control panel will refuse to perform the function.

6.7 SET TIME

[CODE][*][6][#]

The function permits setting the control panel clock (day, month, hour). Present year is set by the installer with the service function. The real indications of time and date ensure correct interpretation of the events recorded in the panel memory log. The history of events may be downloaded by means of the LCD keypad or the computer and its program managing the CA-5 alarm control panel.

The programming procedure is as follows:

- HOURS, MINUTES - acknowledge ([H][H][M][M][#]),
- MONTH, DAY - acknowledge ([M][M][D][D][#]),

The hour should be given in the 24-hour format (with "zero" before the hour less than 10).

It is possible to leave the function earlier after programming the time (the date will remain unchanged) by pressing the ([#]) key twice.

Note: In order to reset the „Clock loss” trouble signal, the time and date must be programmed.

EXAMPLE: programming time: 7:45
and date: 25 July. (user access code = 1230)

[1230] [*] - calling the "user function" mode, confirmed with three short beeps and in the LED keypad additionally with slow blinking of the PROGRAM LED,

[6] [#] - calling the "set time" function confirmed with two short beeps and in the LED keypad additionally with fast blinking of the PROGRAM diode (in the LCD keypad this function may be called using arrow keys),

[0745] [#] - entering the hours and minutes confirmed with two short beeps,

[0725] [#] - entering the month and day confirmed with four short beeps and a long one, quitting the function.

The LCD keypad display present time, but in the LED keypad it is possible to check **the current hour and date** set in the control panel. In order to check the settings, call the user function 6 and pressing the [*] key twice look through the digits displayed on the LEDs (from 2 to 5) as they were programmed. The first digit is displayed immediately on calling the function.

Digits are presented in the binary code according to the table:

		LED INDICATIONS			
LED No.		2	3	4	5
DIGIT					
0		○	○	○	○
1		○	○	○	●
2		○	○	●	○
3		○	○	●	●
4		○	●	○	○
5		○	●	○	●
6		○	●	●	○
7		○	●	●	●
8		●	○	○	○
9		●	○	○	●

○ - LED off
● - LED on

EXAMPLE: checking the time and date of the panel clock (user access code = 1230) - next to the keys are shown examples of LED indications.

[1230] [*] - calling the "user function" mode confirmed with three short beeps and slow blinking of the PROGRAM diode,

- [6][#] ○○○● - calling the number of the „panel clock programming” function confirmed with two short beeps and fast blinking of the PROGRAM diode. The first digit (1) is displayed on the LEDs,
- [*][*] ○●○○ - (5)
- [*][*] ○○●● - (3)
- [*][*] ●○○● - (9)
- [*][*] - two long beeps (the LED indications remain unchanged),

Note: Pressing the [*][#] keys will quit the function, while for checking the date setting, it is necessary to press the [#] key.

- [#] ○○○○ - going over to the date checking step (pressing the [#] key - at this moment - will generate the „Clock programming” event), downloading of next digit (0),
- [*][*] ●○○● - (9)
- [*][*] ○○○● - (1)
- [*][*] ○○○● - (1)
- [*][*] - two long beeps (the LED indications remain unchanged),
- [*][#] - quitting the function without changing the date, signaled by two long beeps.

The following data have been downloaded from the control panel:

time: **15:39**

date: **September 11**

6.8 MONO OUTPUTS

[CODE][*][7][#]

The purpose of the function is determined by the installer. It can, for instance, activate electromagnetic locks, bells, signaling lamps or any other devices. The function is available when the MONO SWITCH type has been selected for one of the outputs.

Using this function switches on the output for a time specified by the installer. Performance is confirmed by four short beeps and a long one.

The function is called in a similar way as for the user function 5.

6.9 BI OUTPUTS

[CODE][*][8][#]

The purpose of the function is determined by the installer. It can be used, for example, for switching on the external lighting or any electrical devices.

The function is active when the BI SWITCH type is selected for one of the outputs.

Using the function permanently changes over the output status. If the output is off, the function will switch it on, and if it is on, the function will switch it off.

Switching the output on is confirmed by the keypad with four short beeps and a long one, while switching it off - with three short beeps.

The function is called in the same way as the user function 5.

6.10 POWER SUPPLY RESET

[CODE][*][9][#]

The function is used for handling special detectors equipped with individual on/off memory, which is cleared by shutting down power supply (for example, smoke detectors). Calling the function temporarily disconnects power supply for such detectors.

The function is active when the RESETTABLE POWER type is selected for one of the outputs.

The function is called in the same way as the user function 5.

6.11 EVENTS

[FUNCTION 10 – ONLY LCD KEYPAD]

The function is available in LCD keypad and makes it possible to view the whole contents of the events log (the last 255). To view the events, the user function menu should be opened

with master user code or with service code, and next the “Events” function should be called. The way of viewing is described in section HOLD DOWN USER FUNCTIONS.

6.12 TESTING OUTPUTS AND LED INDICATORS

[CODE][*][11][#]

The function makes it possible to check the current logical status of the control panel outputs (active/inactive), as well as functioning of the outputs and devices connected to them. After calling the function from the LED type keypad, the control panel will indicate the current status of outputs on LEDs with corresponding numbers: **1** – OUT1, **2** – OUT2, **3** – OUT3. The lit up LED means active output, the extinguished LED inactive output. In the LCD keypad, the status of outputs is displayed on the first three characters of the second line of the display. The active outputs are indicated by displaying a corresponding digit (1, 2, or 3), and the inactive - by displaying a dot. In order to carry out the functional test of the output (arm/disarm), press the key with the number of specified output. By repeatedly pressing the same key the output status will be toggled to the opposite one. Activation / deactivation of an output is acknowledged by three short beeps.

Additionally, the function enables the LEDs installed in the keypad to be checked for proper functioning. Pressing the key [0] when the function is active will light up all the LEDs (indicators and keypad backlighting) in all keypads connected to the alarm control panel. Pressing any key with other digit will extinguish all the LEDs which are inactive at the moment.

After quitting the function key [#] or [*], the control panel will restore the previous status of the outputs, from before calling the function.

6.13 SERVICE ACCESS

[CODE][*][12][#]

The function, which is available to the master user, allows the installer to access the system by using the service code. It requires some data to be entered i.e. the number of hours during which the control panel service mode will be available to the installer / service (up to 99). After this time period expires, the access will be blocked. In order to program the access time, call the function, enter two digits to indicate the number of hours (using zero in the beginning for numbers smaller than 10) and press the [#] key.

Two zeros entered with this function (for the number of hours) automatically block the access.

The access time countdown is running, whether the service mode is active or not. The countdown can only be interrupted by disconnection of power supply (230V mains and/or battery). By calling this function you can check how much time remains until the access is blocked by the service code - the 00 indication means that countdown of the last hour is going on.

7. HISTORY OF MANUAL UPDATES

The changes described refer to the manual drawn up for the CA-5 v1.07 control panel.

DATE	VERSION	DESCRIPTION OF CHANGES
September 2004	1.08	<p>An option to extinguish the ARMED LED on arming has been introduced (p. 4). Different indication of arming with bypassed zones has been introduced (p. 5). Information has been added, regarding the method of the TROUBLE indicator reset (p. 5). Description of the ARMED LED functioning is supplemented (p. 4). Description of the keypad audible signaling is supplemented (p. 5). Information on the TROUBLE LED functioning is added (p. 5). Description of the symbols of control panel zone status has been amended (p. 5). List of user functions has been updated (p. 13) by adding functions 11 and 12. Description of the user function 4 is supplemented by information on new zone-related events (p. 16) and a note on bypassing of 24h zones (p. 16). Description of new user functions is provided (p. 19).</p>
December 2004	1.09	<p>A different way of indicating the zone which caused alarm as the first one has been introduced (p. 4 and 5). A remark on resetting the indicators of alarm from zones has been added (p. 4). Information on properties of the code no. 4 - Duress (p. 6) and reasons for failure to arm has been supplemented (p. 8). User function no. 11: an option to carry out functional test of the keypad LEDs has been added (p. 19) and the function performance description has been updated.</p>

SATEL sp. z o.o.
 ul. Schuberta 79
 80-172 Gdańsk
 POLAND
 Tel. +48 58 320 94 00
 info@satel.pl
 www.satel.pl

LEDs 1+5 (zones state)

on - zone violated

off - zone OK

blinking fast - zone alarm memory

on with short extinguishing every 2 sec. - zone tamper violated

flashing every 2 sec. - zone tamper alarm memory

blinking slowly - zone bypassed

ARMED

on - partition armed,

blinking - exit time in progress

PROGRAM - panel in programming mode

on - service mode

blinking slowly - user function mode

blinking fast - function called

TROUBLE - indicates detection of technical trouble in system - to check press key [7] for 3 sec.

[6] - pressing for 3 sec. activates **trouble memory review**

TROUBLE TYPE DISPLAY:

1st SET OF TROUBLES

- 1 - AC power supply loss
- 2 - Battery trouble (F1 fuse)
- 3 - F2 fuse trouble (OUT1 output)
- 4 - F3 fuse trouble (power supplying outputs KPD and AUX)
- 5 - Clock loss

2nd SET OF TROUBLES (negation of lighting- LEDs off)

- 1 - No voltage on tel. line
- 2 - Problem with access to settings memory
- 3 - Wrong communication codes (connections with computer blocked for 30 minutes)
- 4 - No monitoring confirmation
- 5 - No signal on telephone line

[#] - pressing for 3 sec. activates **PANIC ALARM**

CODE+[#] - arming/disarming, clearing alarm

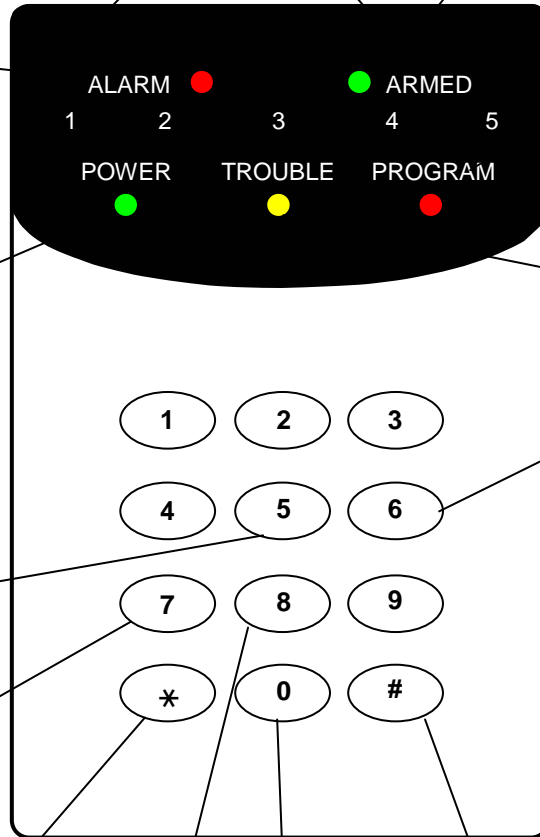

ALARM

on - site alarm

blinking - alarm memory

POWER

on - power supply OK

blinking - battery problem

off - mains supply failure

[5]- pressing for 3 sec. activates **alarm memory review**

[7]- pressing for 3 sec. activates **current trouble display**

[*] - pressing for 3 sec. activates **FIRE ALARM**

CODE+[*] - User Functions:

- CODE [*][0][#] - DOWNLOADING start
- CODE [*][1][#] - change code
- CODE [*][2][#] - add user
- CODE [*][3][#] - erase user
- CODE [*][4][#] - bypass zone
- CODE [*][5][#] - arm silent
- CODE [*][6][#] - set time
- CODE [*][7][#] - MONO outputs
- CODE [*][8][#] - BI outputs
- CODE [*][9][#] - supply reset
- CODE[*][11][#] - output test
- CODE[*][12][#] - service access

[0] - pressing for 3 sec. activates **AUX. ALARM**

[8] - pressing for 3 sec. activates/deactivates chime signaling

armed
on – partition armed,
blinking – exit time delay
in progress.

[5] - pressing for 3 sec.
activates **alarm
memory viewing**

[7] - pressing for 3 sec.
activates **current
trouble display**

[*] - pressing for 3 sec. activates
FIRE ALARM

CODE+[*] - User Functions:

0. Start DWNL
1. Change code
2. New user
3. Erase user
4. Bypass zone
5. Arm silent
6. Set time
7. MONO outputs
8. BI outputs
9. Power supply reset
10. Events
11. Output test
12. Service access

alarm
on - site alarm
blinking - alarm memory

LCD DISPLAY – date and hour
Status of armed zones:

- - zone OK
- - zone violated
- - 2EOL zone tamper violated
- a - zone alarm
- s - memory of 2EOL zone tamper alarm
- b - zone bypassed

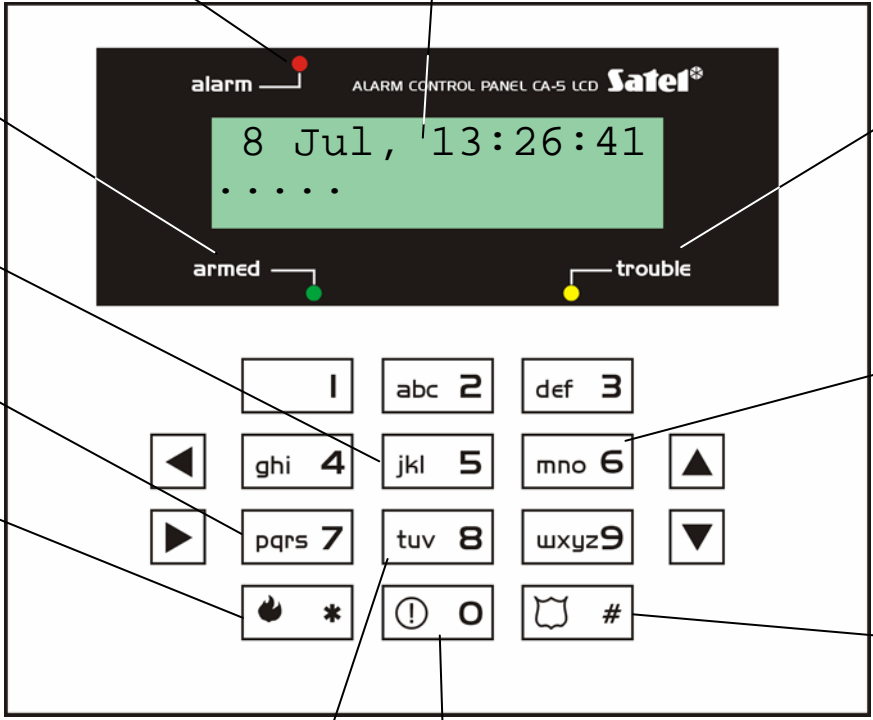

trouble – indicates
detection of technical
trouble in system - to check
press key [7] for 3 sec.

[6] - pressing for 3 sec.
activates **trouble
memory viewing**

[#] - pressing for 3 sec.
activates **PANIC ALARM**

CODE+[#] – arming/disarming,
clearing alarm

[8] - pressing for 3 sec.
activates/deactivates
chime signaling

[0] - pressing for 3 sec. activates
AUX. ALARM