

These manual apply to the CA64T v1.4 module with software version 4.00.

ca64ptsa_e 02/05

The synoptic board with software version **4.00** can interface with the **CA-64** alarm control panel, the **INTEGRA** series control panels, or the **STAM-1** monitoring station. The module automatically recognizes the equipment it is connected to.

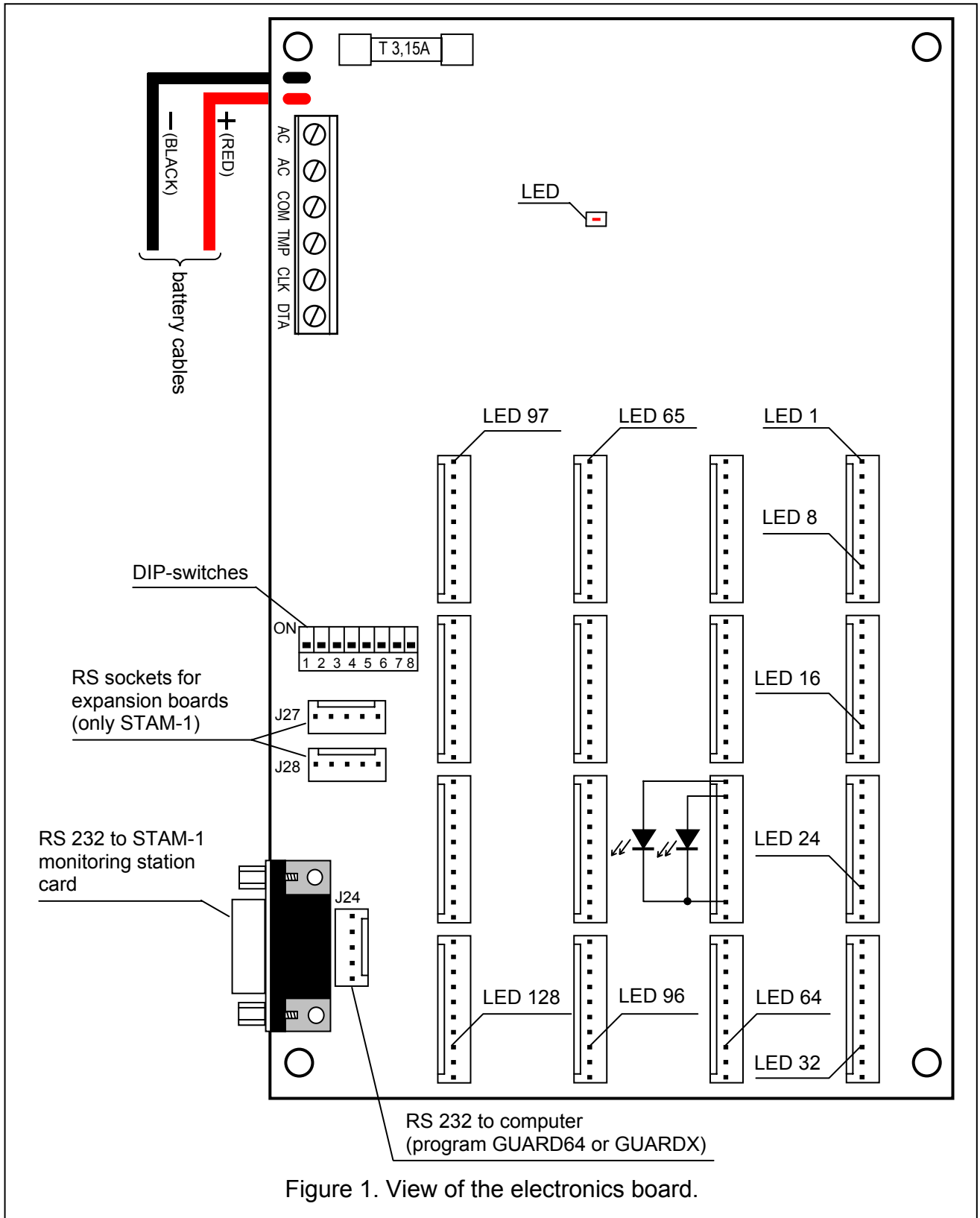

1. POWER SUPPLY CONNECTION

The board has its own independent power supply with a battery backup. To energize the board, connect the alternating voltage of 17..24 V from a mains transformer rated at least at 30VA to the AC inputs.

The battery connected to the synoptic board serves for backup of the LEDs' status in the event of mains power failure but is not necessary for correct operation of the system.

The power supply has a battery charging / testing circuit with disconnection of discharged battery - the battery cut-off voltage is 9,5V \pm 0,3V. The battery charging current is 350mA.

The LED indicator on the electronics board is on when the battery status is being tested by the module and when the discharged battery is being charged. In the process of testing, the processor reduces the power supply voltage, and the module and LEDs are battery supplied. The testing takes place every 4 minutes and lasts 10 seconds.

2. INTERACTION WITH ALARM CONTROL PANEL

The synoptic board is to be connected to the keypad bus of alarm control panel (synoptic board terminals: COM, CLK, DTA; main board terminals of control panel: COM, CKM, DTM). The TMP input serves the same purpose as the keypad tamper contact. If the TMP input is not used, it should be connected to COM terminal.

The synoptic board should be configured by means of the DIP-switches on the electronics board, only DIP-switches 1-6 being used (set the switches 7 and 8 in OFF position).

2.1 Synoptic board operation in monitoring mode

For the synoptic board to operate in the monitoring mode, set the switch 4 in OFF position. The status of DIP-switches 1-3 as well as 7 and 8 is irrelevant. The switches 5 and 6 are only important if the synoptic board is used in conjunction with the INTEGRA 128 control panel, and their position determines what is displayed on the LEDs. As regards the other control panels, position of the DIP-switches 5 and 6 has no meaning. Configuration of the synoptic board for interaction with the INTEGRA 128, depending on the position of DIP-switches 5 and 6, is shown in the table below.

Display mode	DIP-switches		LEDs		
	5	6	1 - 64	65 - 96	97 - 128
Zones 1...64 and partitions	OFF	OFF	zones 1 - 64	partitions armed 1 - 32	partition alarms 1 - 32
Zones 65...128 and partitions	OFF	ON	zones 65 - 128	partitions armed 1 - 32	partition alarms 1 - 32
Zones 1...128 only	ON	OFF	zones 1 - 64	zones 65 - 96	zones 97 - 128
	ON	ON			

If used with the CA-64, INTEGRA 24, INTEGRA 32, INTEGRA 64 control panels, the synoptic board always operates in the **Zones 1...64 and partitions** mode, because of the number of available zones in these control panels.

If necessary, the monitoring mode permits connection of any number of synoptic boards. The only operation performed in this mode by the board is the cyclic read-out of data on the status of the control panel zones and partitions, and representation of this status on the board LEDs. The logic of LEDs blinking is shown below. The 2-second sequence consists of 8 time segments and the LED can be ON or OFF in each of them. The digit 1 represents the LED ON, and the digit 0 - the LED OFF.

Zones:

Bypass	11110000
Trouble - long violation:	10101000
Trouble – no violation:	10100000
Tamper alarm:	10000000
Alarm:	10101010
Tamper:	11111110
Violation:	11111111
Tamper memory:	10000000
Alarm memory:	10101010
Zone OK:	00000000

Partitions:

Entry time delay:	11111110
Exit time delay < 10 s.:	10101010
Exit time delay > 10 sek.:	11110000
Armed:	11111111
Not armed:	00000000

Alarms:

Fire alarm:	11001100
Alarm:	11111111
Fire alarm memory:	10000000
Alarm memory:	11111110
No alarms:	00000000

2.2 Synoptic board operation in keypad mode

For the synoptic board to operate in this mode, set the DIP-switch 4 in ON position. The switches 1-3 are used for setting the board address. Position of the other DIP-switches has no meaning.

Note: The board address cannot be the same as the address of a keypad or another board.

In this mode, the board operates as in the monitoring mode, additionally reporting to the control panel on the following events: restart, battery / AC trouble and battery / AC restore, tamper and tamper restore. A computer with the Guard64 (CA-64 control panel) or GuardX (INTEGRA control panels) program installed can be connected to the synoptic board working in the keypad mode.

When in the keypad mode, it is possible to define the LED blinking pattern by program means, using the LCD keypad (→Service mode →Structure →Hardware →LCD keypads →Settings →select synoptic board), Dload64 program (CA-64 control panel) or DloadX program (INTEGRA series panels).

To define the LED operating mode you should program a 2-second blinking sequence for the corresponding **Zones state**, **Partitions armed** or **Alarms in partitions**. When programming, define whether the LED in the particular time segment is to be ON or OFF.

In the keypad, you can program the time sequence for particular states by entering the corresponding function in the service mode:

→Structure →Hardware →LCD keypads →Settings →select synoptic board →select indicated state

Illumination of the LED in any time segment is indicated by the ■ sign on the display. The illumination in the segment indicated by the cursor can be switched ON and OFF by pressing any numeric key. To move the cursor, press the ◀ ▶ arrow keys.

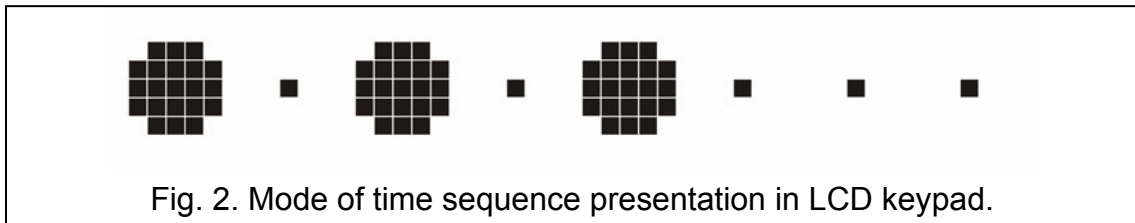

Fig. 2. Mode of time sequence presentation in LCD keypad.

Programming of the time sequence in the Dload64 and DloadX programs is effected by means of the mouse: move the cursor to select the time segment and click on it to switch the LED illumination ON or OFF. The LED "ON" status is indicated by orange color of the field corresponding to the time segment.

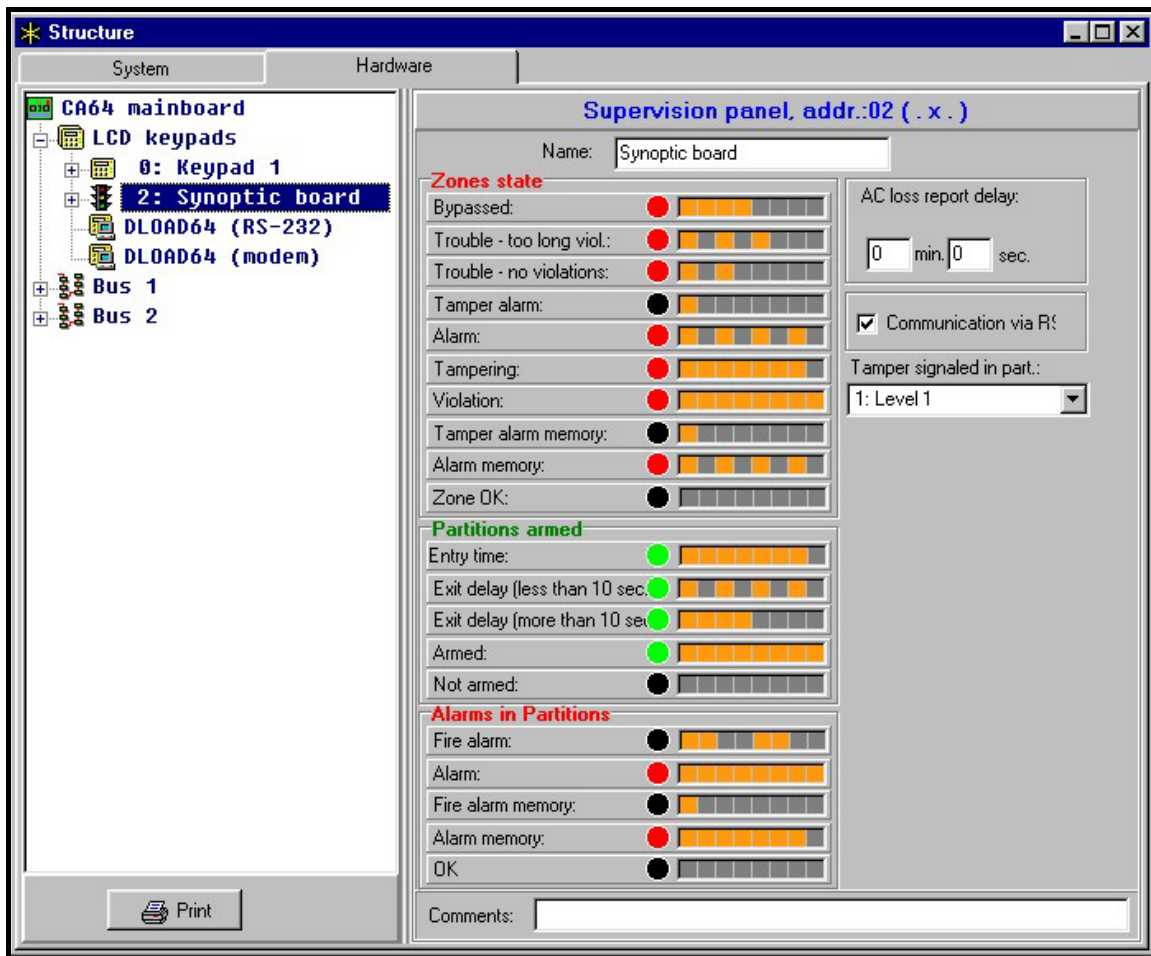

Fig. 3. Programming the synoptic board settings in the Dload64 program.

Using the LCD keypad, Dload64 or DloadX program you can also determine whether communication between the synoptic board and the Guard64 or GuardX program should be allowed. In case of the INTEGRA 128 alarm control panel, you can define the display mode, using the LCD keypad or a computer with DloadX program (the available display modes are described above in this manual).

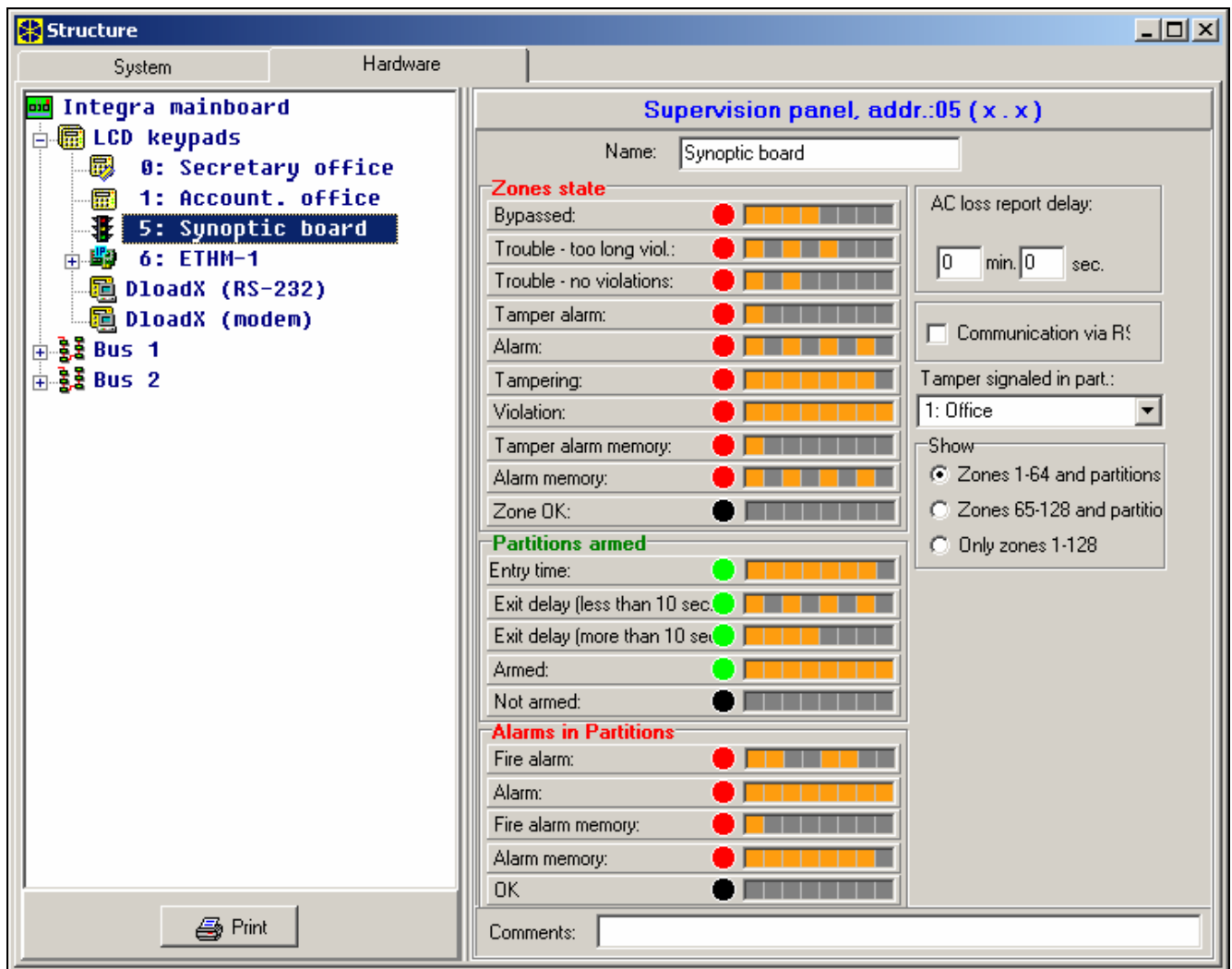

Fig. 4. Programming the synoptic board settings in the DloadX program for the INTEGRA 128 control panel.

3. INTERACTION WITH THE STAM-1 MONITORING STATION

The board is designed to work in conjunction with the SATEL STAM-1 monitoring station, based on software version 3.17 or later. The purpose of the board is visualization of the state of monitored objects by means of LEDs e.g. on a city map or a site plan. Each subscriber's status can be shown with two LEDs, which permits legible representation of the supervised objects when LEDs of different colors (e.g. red and green) are used. There is also an option to use one two-color LED instead of two one-color LEDs (for each subscriber), which makes it possible to obtain a third color of light when both LEDs are on at the same time (for a red-and-green LED, it will be yellow color). The mode of the LEDs illumination is defined by the supervisor, depending on the object state, in the STAM-1 program (in the menu 'Configuration| Synoptic Boards'). The following states can be distinguished:

- object is armed,
- object is partially armed,
- object is disarmed and trouble occurs,
- unattended alarm from an armed object,
- an object partition should be armed, but it is not,
- etc.

One synoptic board enables visualization of the state of 64 objects. For a greater number of objects, it is necessary to connect an expansion card to the basic board. Altogether, 63

synoptic boards can be connected in one system, which makes up 4032 visualized objects. If one board only is used and the number of subscribers in the system exceeds 64, the board will only show the subscribers with numbers from 1 to 64 (subscriber no. 1 on LEDs 1 and 2, subscriber no. 2 on LEDs 3 and 4, etc.).

3.1 Synoptic board connection

In order to hook up the synoptic board to the monitoring station, you need, besides the mother-board (STAM-1 P), also an terminal (STAM-1 K) card, to which the synoptic board is connected (apart from these two cards, expansion cards may also be used). The synoptic board is connected to the terminal card by means of a special cable, included in the synoptic board delivery. The consecutive synoptic boards are connected to the basic synoptic board with the use of RS cables, as are used for interconnecting the receiving cards. DIP-switches on the electronics board are intended for setting the synoptic board address, only the switches 1-6 being used (the switches 7 and 8 should be set in OFF position). Particular switches have significance as shown in the table below.

Switch number	1	2	3	4	5	6
Numerical equivalent (bit significance)	1	2	4	8	16	32

Examples of addressing:

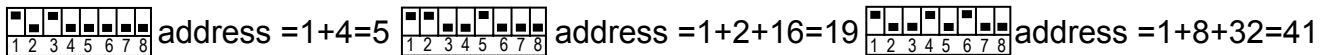

Depending on the set address, configuration of the board is as follows:

- address 0 - the board attends to subscriber numbers from 1 to 64,
- address 1 - the board attends to subscriber numbers from 65 to 128,
- address 2 - the board attends to subscriber numbers from 129 to 192,
- etc.

In the event of a 10-minute break in the data transmission from the STAM-1 station, the synoptic board will perform the restart procedure, which will be signaled by 5-second blinking of all the LEDs connected to it.

4. LEDs CONNECTION

The synoptic board is designed to accept typical LEDs with a current consumption of approx. 7mA. The LEDs are connected to the synoptic board by means of 10-pin plugs. Each plug enables 8 LEDs to be connected.

Figure 5 shows how the contacts are assigned to the corresponding zones or partitions when the synoptic board is used in conjunction with the alarm control panel. Figure 6 illustrates assignment of the contacts to the corresponding subscribers in the event when the synoptic board interfaces with the STAM-1 monitoring station.

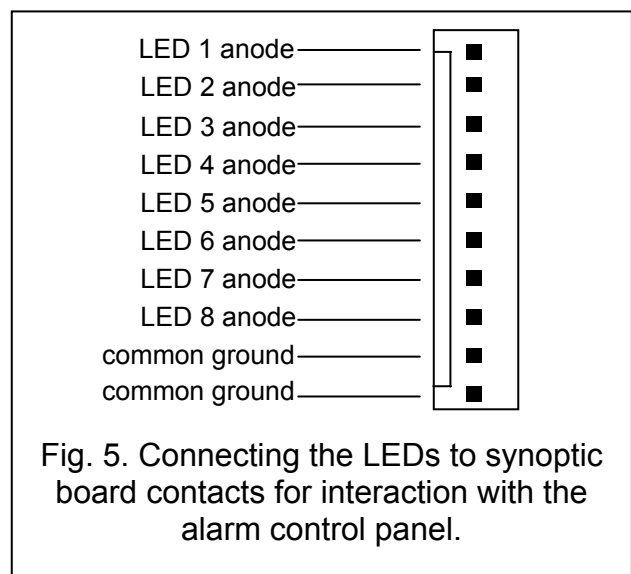

Fig. 5. Connecting the LEDs to synoptic board contacts for interaction with the alarm control panel.

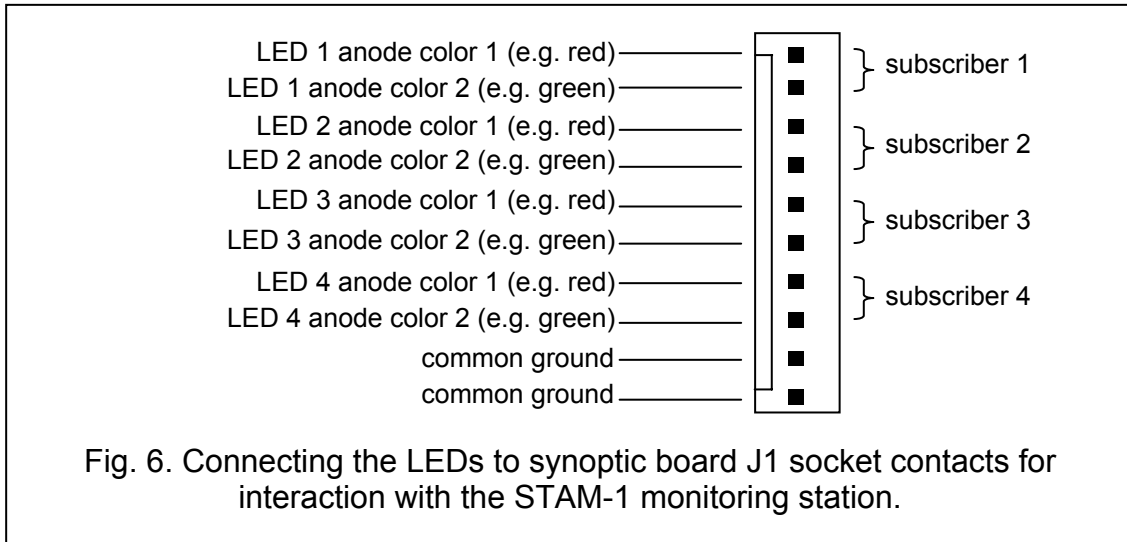

Fig. 6. Connecting the LEDs to synoptic board J1 socket contacts for interaction with the STAM-1 monitoring station.

5. TECHNICAL DATA

Supply voltage	AC 17...24V
Power supply current efficiency	1.3A
Battery charging voltage	13.7 ±0.1V
Battery cut-off voltage	9.5 ±0.3V
Dimensions	173x102x37mm

The latest EC declaration of conformity and certificates are available for
downloading on website **www.satel.pl**



SATEL sp. z o.o.
ul. Schuberta 79
80-172 Gdańsk
POLAND
tel. + 48 58 320 94 00
info@satel.pl
www.satel.pl