

The ACX-100 input/output expansion module interfaces with the ACU-100 wireless system controller. It enables the system to be expanded by additional 8 outputs and 4 control inputs. The ACU-100 controller accepts up to five ACX-100 modules. Both the outputs and the control inputs have the same features as in the ACU-100 controller.

## 1. DESCRIPTION OF ELECTRONICS BOARD

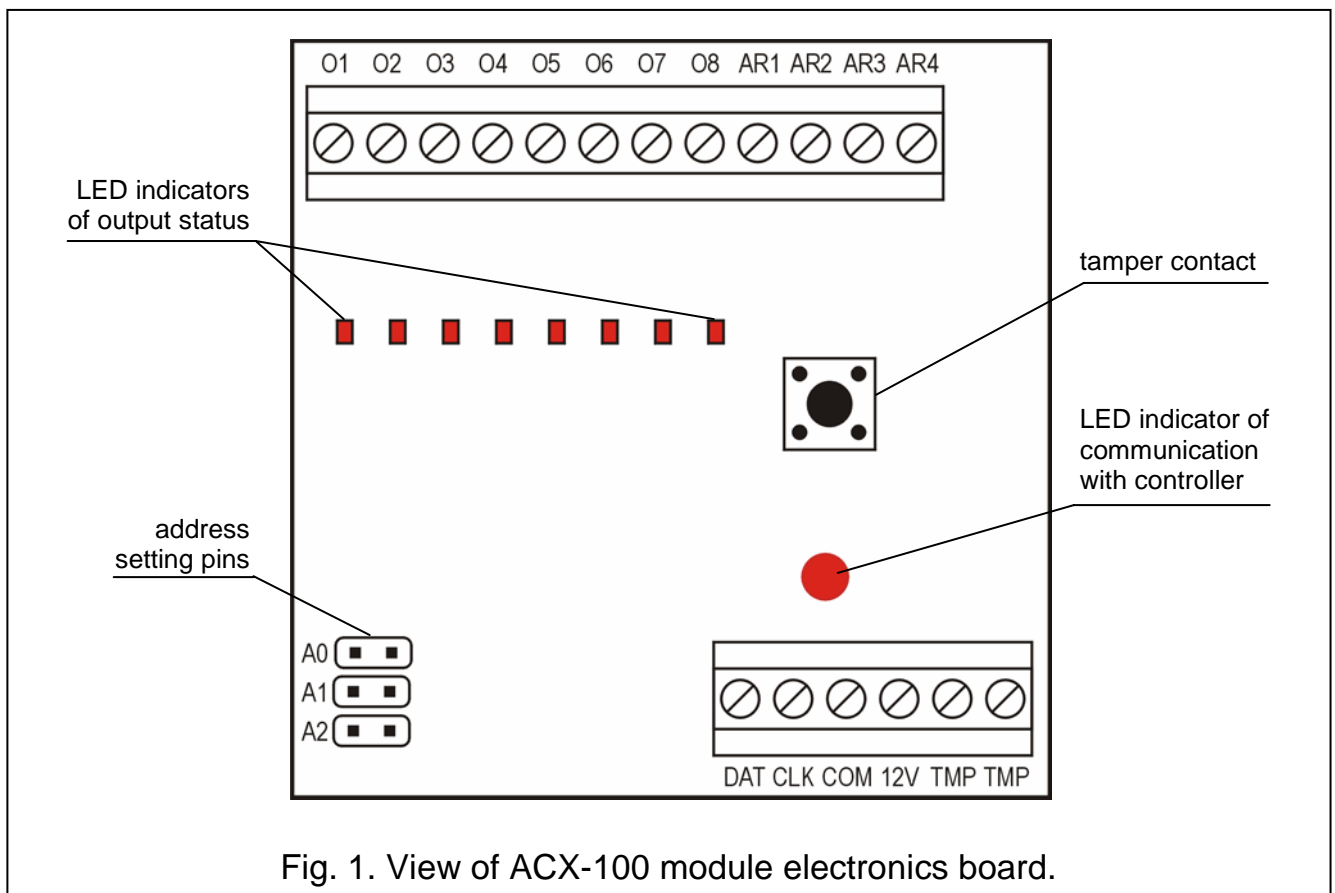

Fig. 1. View of ACX-100 module electronics board.

### Description of terminals:

- O1...O8** - outputs of information on state of wireless devices
- AR1...AR4** - control inputs
- DAT, CLK** - communication bus
- COM** - common (ground)
- 12V** - supply input
- TMP** - tamper contact terminals of the module (NC)

**The tamper contact** reacts to opening of the controller housing. The tamper contact terminals can be connected to the tamper circuit of the control panel.

**The communication bus (CLK, DAT)** of the module enables connection to the ACU-100 controller communication bus. If the ACX-100 module is connected to the















controller, the controller cannot be connected to the control panel through the communication bus.

**The LED indicator** situated at the communication bus terminals indicates by blinking the communication with the ACU-100 controller. The blinking frequency depends on the number of ACX-100 modules connected to the controller: it gets slower as the number of modules increases. If there is no communication with the controller, the LED is constantly on and, additionally, all the LEDs indicating the status of outputs come on.

**The pins A0, A1 and A2** are used for setting an individual address of the module (see Table 1). Each ACX-100 module connected to the ACU-100 controller must have a different address from the 0 - 4 range (if a higher address is set, it will be read as 4). The address must correspond to the number of a next module in the system according to Table 2. If one ACX-100 module is connected to the controller, it requires the address 0, if two - one of them requires the address 0 to be set, and the other - the address 1, etc.

Pins	A0	A1	A2
Numerical value (with jumper set)	1	2	4

Table 1.

Consecutive module number	Module address	Pins		
		A0	A1	A2
1	0			
2	1			
3	2			
4	3			
5	4			

 - pins shorted

 - pins open

Table 2.

The method of numbering the outputs and control inputs of the ACX-100 modules in the wireless system is described in the ACU-100 controller manual.

## 2. INSTALLATION

The ACX-100 input/output expansion module is installed in a plastic housing. It should be installed indoors, in spaces with a normal air humidity. It is recommended that all connections be made with power supply disconnected.

In view of the necessity to connect the module outputs/inputs with the alarm control panel, it is advisable to install the module in the vicinity of the control panel. Thus the length of the cables connecting the module with the panel will be minimized.

For further information regarding operation of the ACX-100 module in the wireless system and use of the outputs and control inputs please refer to the ACU-100 controller manual.

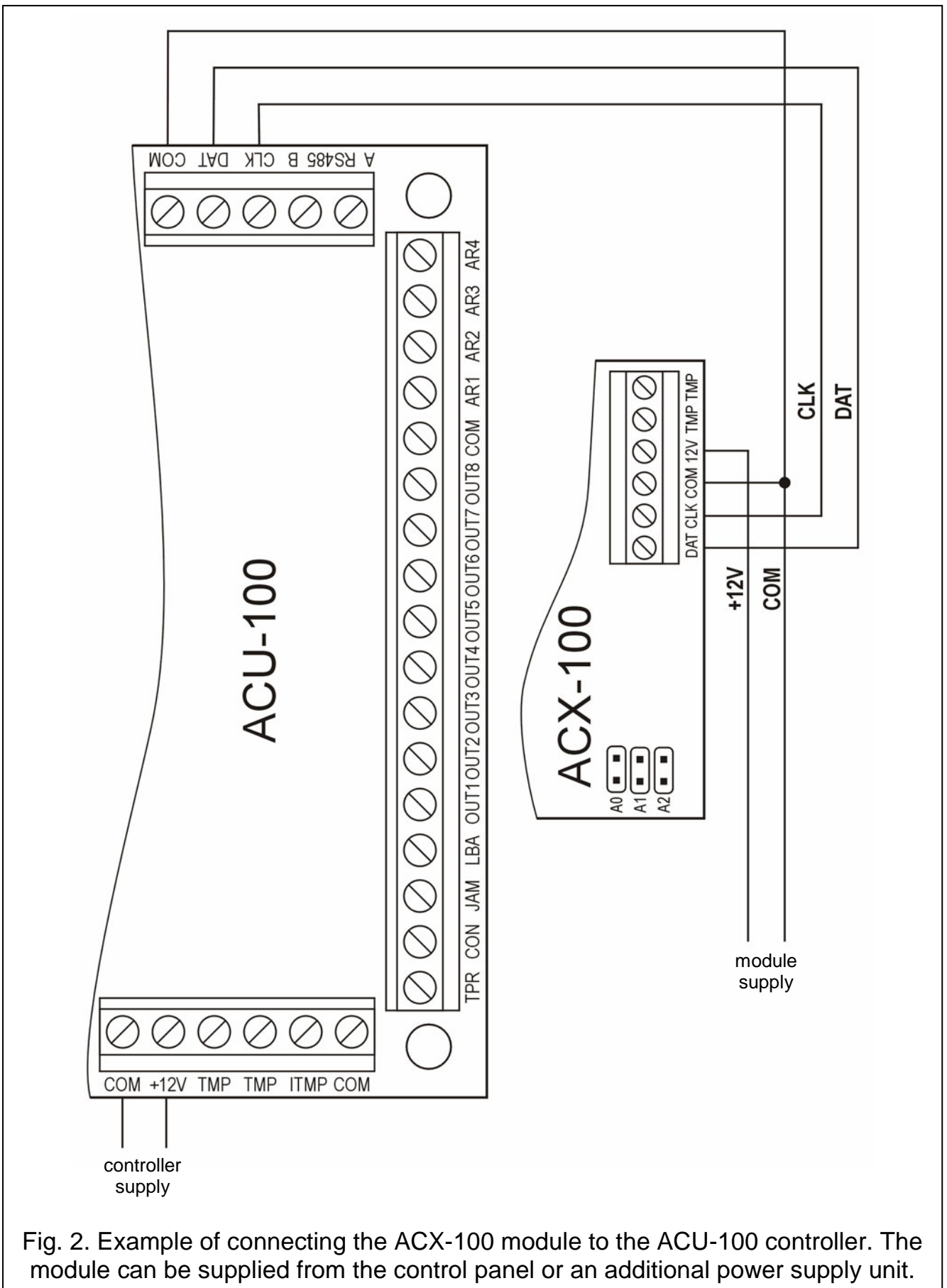

Fig. 2. Example of connecting the ACX-100 module to the ACU-100 controller. The module can be supplied from the control panel or an additional power supply unit.

### 3. TECHNICAL DATA

Nominal supply voltage .....	12V DC $\pm$ 15%
Current consumption, average .....	26mA
Outputs current-carrying capacity.....	50mA
Operating temperature range .....	0°C...+55°C
Housing dimensions .....	72x118x24mm

#### DECLARATION OF CONFORMITY

**CE1471**

**Product:**  
ACX-100 - Expander of ABAX Wireless System  
Controller

**Manufacturer:** SATEL spółka z o.o.  
ul. Schuberta 79  
80-172 Gdańsk, POLAND  
tel. (+48 58) 320-94-00  
fax. (+48 58) 320-94-01

**Product description:** The ACU-100 controller expander, increasing the number of the ACU-100 controller inputs and outputs. The device is intended to be used in burglary and panic alarm systems.

**This product conforms to the following EU Directives:**  
R&TTE 1999/5/EC

**This product meets requirements of the harmonized standards:**  
EMC: ETSI EN 301 489-1: v.1.5.1.; EN 301 489-3: v.1.4.1  
Safety: EN60950-1:2001

**Notified body taking part in conformity evaluation:**  
Identification No.: 1471

Gdańsk, Poland 2005-07-15

**Head of Test Laboratory:**  
Michał Konarski



The latest EC declaration of conformity and product approval certificates are available for downloading on our website j [www.satel.pl](http://www.satel.pl)