

**abox2**

Wireless smoke and heat detector

**ASD-200**

Firmware version 2.02

**EN**

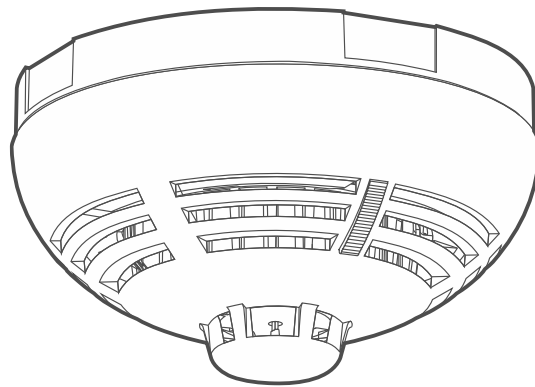

**CE**

asd-200\_en 05/24

**Satel**  <sup>®</sup>

SATEL sp. z o.o. • ul. Budowlanych 66 • 80-298 Gdańsk • POLAND  
tel. +48 58 320 94 00  
[www.satel.pl](http://www.satel.pl)

## IMPORTANT

The device should be installed by qualified personnel.

Prior to installation, please read carefully this manual in order to avoid mistakes that can lead to malfunction or even damage to the equipment.

Changes, modifications or repairs not authorized by the manufacturer shall void your rights under the warranty.

The rating plate of the device is located on the enclosure base.



The device meets the requirements of the applicable EU directives.



The device is designed for indoor installation.



The device must not be disposed of with other municipal waste. It should be disposed of in accordance with the existing rules for environment protection (the device was placed on the market after 13 August 2005).



The device meets the technical regulations of the Eurasian Customs Union.

SATEL aims to continually improve the quality of its products, which may result in changes in their technical specifications and software. Current information about the changes being introduced is available on our website.

Please visit us at:  
<https://support.satel.pl>

**Hereby, SATEL sp. z o.o. declares that the radio equipment type ASD-200 is in compliance with Directive 2014/53/EU. The full text of the EU declaration of conformity is available at the following internet address: [www.satel.pl/ce](http://www.satel.pl/ce)**

**In the EU, this radio equipment is only permitted to operate in the 868 MHz frequency band.**

The following symbols may be used in this manual:



- note,



- caution.

## CONTENTS

1	Features .....	2
2	Description.....	2
	Radio communication .....	2
	Fire alarm .....	3
	Operating modes .....	3
	Detector test .....	4
	Tamper .....	4
	Test mode.....	4
	LED indicator .....	4
	Energy saving mode (ECO).....	4
	Detection of optical chamber soiling .....	4
	Battery status control .....	4
3	Selecting a mounting location .....	4
4	Installation .....	5
5	Maintenance .....	7
6	Cleaning the optical chamber .....	7
7	Battery replacement.....	9
8	Specifications .....	9

The ASD-200 multisensor detector can detect the early stages of fire development when there is some visible smoke and/or temperature rise. It is designed for operation within the ABAX 2 / ABAX two-way wireless system. This manual applies to the detector with electronics version 1.2, which is supported by:

- ABAX 2:
  - ACU-220 / ACU-280 controller (firmware version 6.08 or newer),
  - ARU-200 repeater.
- ABAX:
  - ACU-120 / ACU-270 controller (firmware version 5.04 or newer),
  - ARU-100 repeater (firmware version 2.02 or newer),
  - INTEGRA 128-WRL control panel (firmware version 1.19 or newer and firmware version of processor used to operate ABAX system 3.10 or newer).



*The detector is not a construction product as defined in Regulation (EU) No 305/2011 of the European Parliament and of the Council of 9 March 2011.*

## 1 Features

---

- Visible smoke sensor.
- Detection of optical chamber fouling.
- Heat sensor.
- Selection of detector operating mode (Smoke and temperature detection / Smoke detection only / Temperature detection only).
- Built-in sounder.
- LED indicator.
- Test / reset button.
- Battery status control.
- ECO option for longer battery life (ABAX 2 system only).
- Encrypted two-way radio communication in the 866 MHz / 868 MHz / 915 MHz frequency band (AES standard for the ABAX 2 system).
- Transmission channel diversity – 4 channels for automatic selection of the one that will enable transmission without interference with other signals in the 866 MHz / 868 MHz / 915 MHz frequency band (ABAX 2 system only).
- Remote update of detector firmware (ABAX 2 system only).
- Tamper protection against enclosure opening.

## 2 Description

---

The ASD-200 detector occupies one position on the list of wireless devices.

### Radio communication

The detector connects to the controller / control panel at regular time intervals to provide information about its state (periodical communication). Additional communication takes place in the case of alarm (smoke / high temperature is sensed by the detector) or tamper (tamper switch has been opened) and after restore of alarm (smoke / high temperature is sensed no more by the detector) or tamper (tamper switch has been closed).

## Fire alarm

### **Smoke detection**

An optical method is used for the detection of visible smoke. When the concentration of smoke in the optical chamber exceeds a given threshold, an alarm is triggered. The smoke sensor operating parameters are modified depending on the temperature changes recorded by the heat sensor (thermistor). The detector automatically compensates for gradual changes in the optical chamber caused by deposition of dust.

### **Temperature detection**

The temperature exceeding 54°C or a too fast temperature rise (see table 1) will trigger an alarm.

Air temperature rise velocity	Lower limit of response time	Upper limit of response time
1°C/min	29 min	40 min 20 s
3°C/min	7 min 13 s	13 min 40 s
5°C/min	4 min 9 s	8 min 20 s
10°C/min	1 min	4 min 20 s
20°C/min	30 s	2 min 20 s
30°C/min	20 s	1 min 40 s

Table 1. Response time limits for the heat sensor.

### **Fire alarm signaling**

The alarm is indicated visually (LED indicator ON) and acoustically (continuous sound) for 5 minutes. Pressing the test / reset button (Fig. 1) during the alarm will clear the alarm condition.

### **Operating modes**

You can select the operating mode when configuring the ASD-200 detector settings (see the controller / control panel manual):

- Smoke and temperature detection – smoke and temperature sensors are enabled.
- Smoke detection only – only smoke sensor is enabled.
- Temperature detection only – only temperature sensor is enabled.

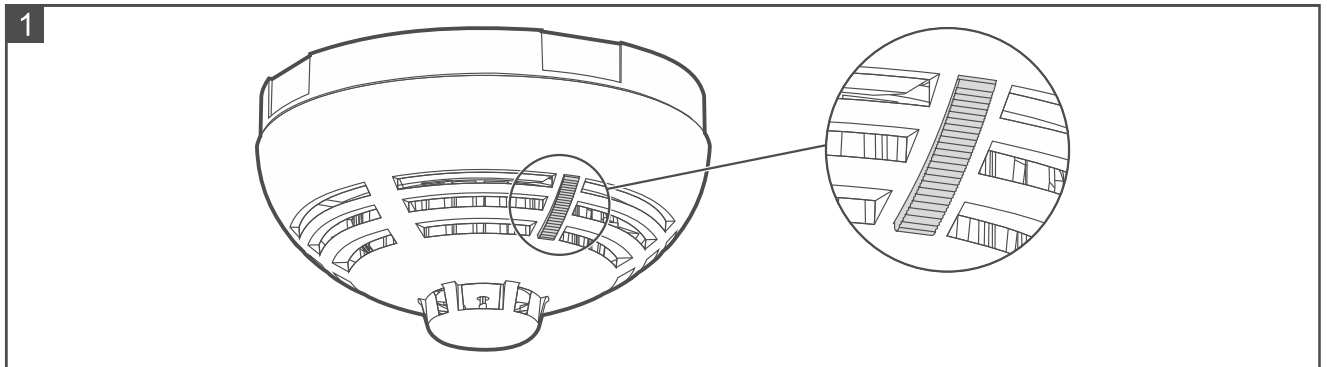

## Detector test

If you want to test operation of the detector, press the test / reset button (Fig. 1). A short sound will be heard. After a few seconds, the fire alarm should be triggered.

## Tamper

Opening the enclosure (opening the tamper switch) is treated as tamper.

## Test mode

The test mode makes diagnostics of the detector easier, because the detector LED indicator indicates periodical communication and alarm memory. How to start and end the test mode is described in the ABAX 2 / ABAX controller manual / the INTEGRA 128-WRL control panel manual.



*The alarm memory is cleared after ending the test mode.*

## LED indicator

LED indicator indicates:

- low battery – 3 short flashes every 30 seconds,
- alarm – ON for 5 minutes.

When the ABAX 2 / ABAX system is running in the test mode, the LED indicator indicates additionally:

- periodical communication – short flash (80 milliseconds), and when the chamber is soiled - 2 short flashes,
- memory of alarm triggered by smoke sensor – flashing rapidly,
- memory of alarm triggered by heat sensor – flashing slowly.

## Energy saving mode (ECO)

If you want to prolong the battery life, you can enable in the detector the *ECO* option. When the *ECO* option is enabled, the periodical communication takes place every 3 minutes. Thus the battery life can be increased as much as fourfold. The option is only available in the ABAX 2 system.

## Detection of optical chamber soiling

The detector is monitoring the state of the optical chamber. Deposition of dust in it may lead to malfunctioning of the device. When the optical chamber requires cleaning, it is indicated by the LED indicator.

## Battery status control

When the battery voltage is lower than 2.75 V, the detector indicates low battery: 3 short flashes of the LED indicator and 3 short beeps every 30 seconds. The low battery info is sent during each transmission to the controller / control panel.

## 3 Selecting a mounting location

---

- The detector is designed for indoor installation.
- The detector should be installed in location close to the building / apartment exit (e.g. in the hall, lobby etc. – Fig. A and B).

- In the typical home or office applications, the detector should be installed on the ceiling, as close as possible to the center of the room.
- Do not install the detector in places with high concentration of dust and/or formation and condensation of water steam.
- Do not install the detector near heaters, cookers, fans or air-conditioner outlets.
- Do not install the detector in places where there is no unobstructed movement of air (e.g. in recesses, niches, etc.).
- It is not advisable to install it in close vicinity of electrical systems, because it can adversely affect the range of radio signal.

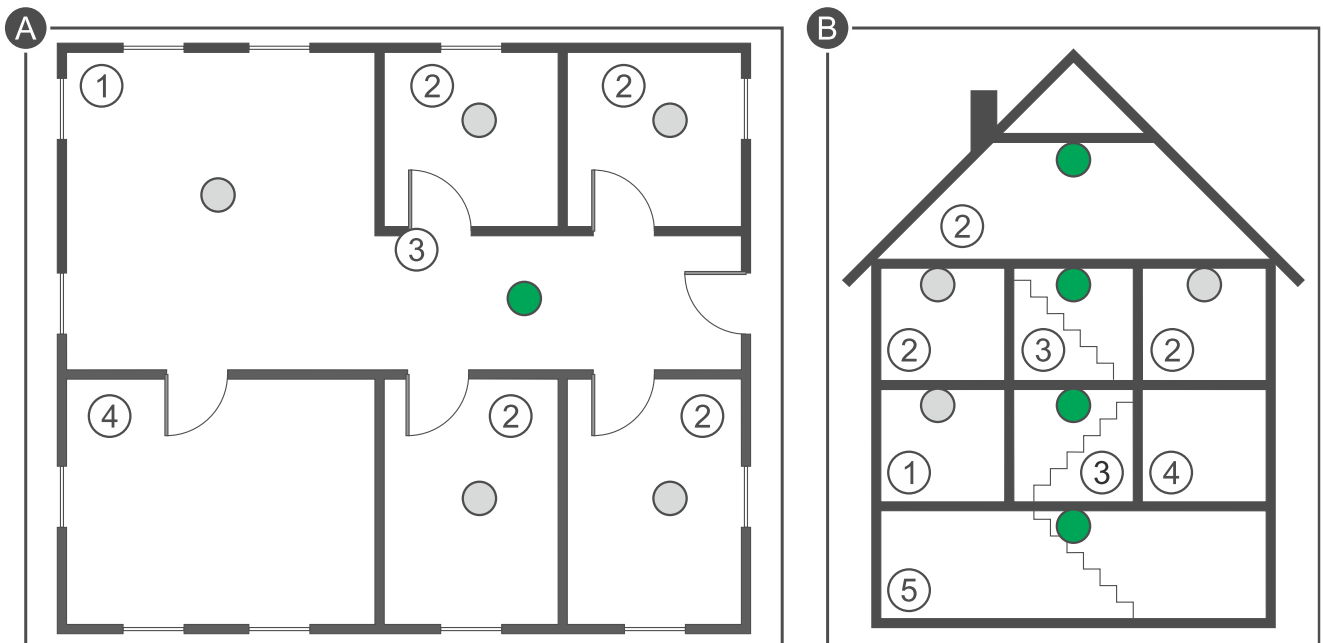

Legend for Figures A and B:

- ① living room.
- ② room.
- ③ hall, lobby, etc.
- ④ kitchen.
- ⑤ basement.
- basic location for detector installation.
- additional location for detector installation.

## 4 Installation



**The detector enclosure can not be closed without the battery inserted.**

**Do not install the battery if the sounder is disconnected.**

**There is a danger of battery explosion when using a different battery than recommended by the manufacturer, or handling the battery improperly. Do not crush the battery, cut it or expose it to high temperatures (throw it into the fire, put it in the oven, etc.).**

**Do not expose the battery to very low pressure due to the risk of battery explosion or leakage of flammable liquid or gas.**

**Be particularly careful during installation and replacement of the battery. The manufacturer is not liable for the consequences of incorrect installation of the battery.**

1. Remove the plastic dust cap.
2. Turn the cover counter-clockwise (Fig. 2) and remove it (Fig. 3).

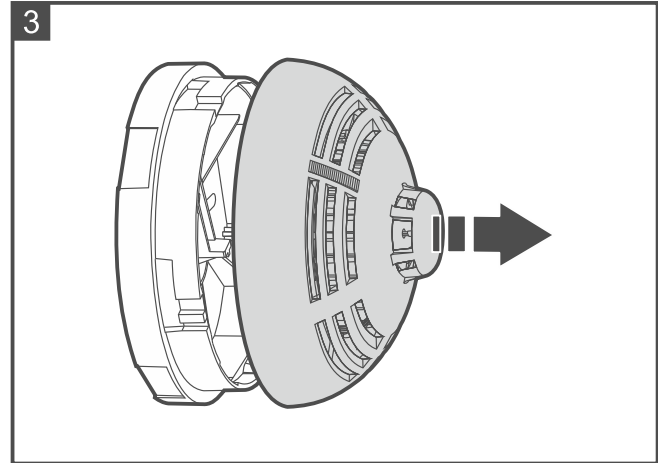
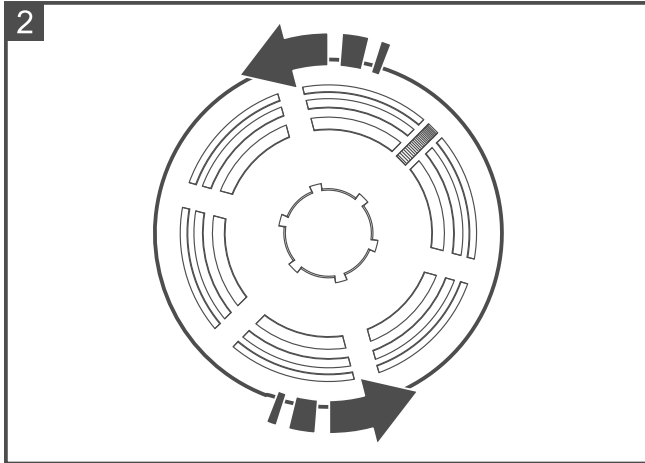

3. Install the battery.
4. Add the detector to the wireless system (see the ABAX 2 / ABAX controller manual or the INTEGRA 128-WRL control panel installer manual). The sticker with serial number which shall be entered when registering the detector in the system can be found on the enclosure base.



*In the INTEGRA / VERSA alarm system, the detector is identified as ASD-110.*

*Simultaneous operation of the detector by the ABAX 2 and ABAX controller / INTEGRA 128-WRL alarm control panel is not possible.*

5. Select the operating mode of the detector (see the ABAX 2 / ABAX controller manual or the INTEGRA 128-WRL control panel installer manual).
6. Replace the cover.
7. Put the detector at the place of its future installation.
8. Check the level of signal received from the detector by the ABAX 2 / ABAX controller or the INTEGRA 128-WRL control panel. If the signal level is lower than 40%, select another place for installation. Sometimes, it is sufficient to shift the device ten or twenty centimeters. You can also try to turn the enclosure to check if it improves the signal strength.



*The ARF-200 tester makes it possible to check the radio signal strength at the place of future installation without having to put the detector there.*

9. Remove the detector cover.
10. If the detector is to be mounted on the ceiling using a double-sided mounting tape:
  - stick the tape to the enclosure base (Fig. 4).
  - stick the enclosure base to the ceiling.
11. If the detector is to be mounted on the ceiling with screws:
  - place the enclosure base against the ceiling and mark the location of the mounting holes (Fig. 5).



- drill the holes in the ceiling for wall plugs (anchors). The wall plugs provided with the detector are intended for concrete or brick. For other types of surface (drywall, styrofoam), use other appropriately selected wall plugs.
- secure the enclosure base to the ceiling with screws.

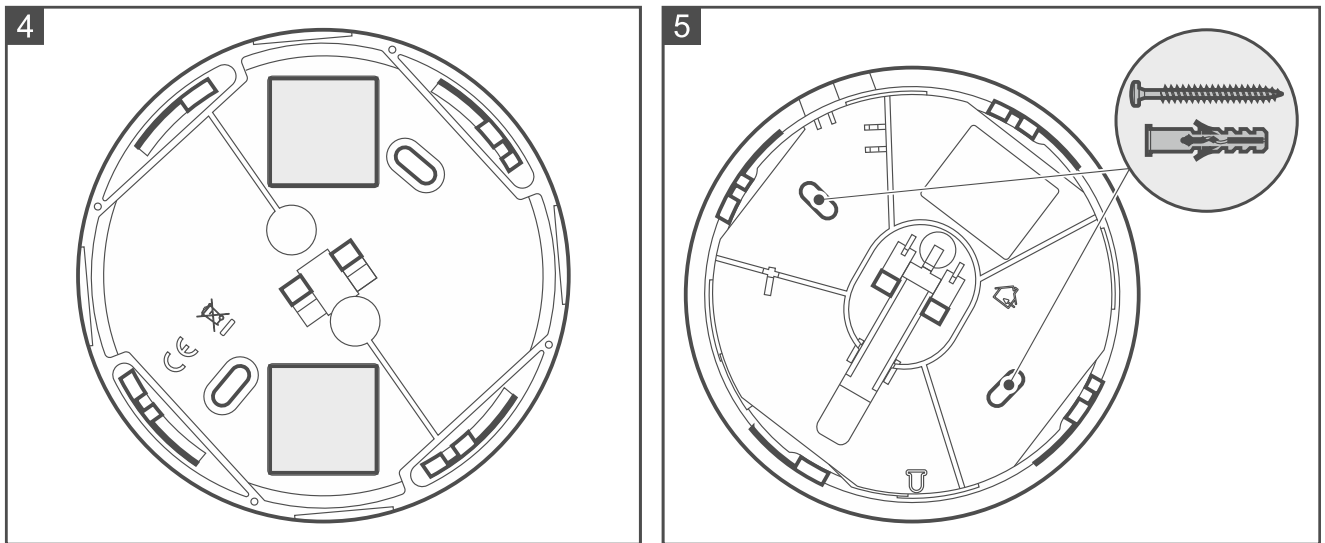

12. Replace the detector cover and lock it with a screw. The screw is provided in a bag together with the wall plugs and screws for mounting.
13. Press the test / reset button (Fig. 1). Fire alarm should be triggered.
14. Press again the test / reset button to clear the alarm.



*If in the premises where the detector is installed, any work is being carried out that may cause dirt to build up in the optical chamber, put a plastic dust cover on the detector. Remove it after the work is finished.*

## 5 Maintenance

The detector should be subjected to regular checks for correct functioning. The periodic checks should be carried out at least every 6 months. To check whether the detector is operating properly, press the test / reset button (Fig. 1). This should trigger a fire alarm.

## 6 Cleaning the optical chamber

It is recommended that you have the optical chamber cleaned at least once a year. Cleaning the chamber is necessary when the LED indicator indicates fouling of the chamber (2 short flashes during periodical communication with controller / control panel).

1. Start the service mode in the control panel (if the controller is connected to a SATEL alarm control panel).
2. Remove the cover locking screw.
3. Turn the cover counter-clockwise (Fig. 6) and remove it (Fig. 7).
4. Remove the battery.
5. Pull the release lever (Fig. 8) to unlock the electronics module and turn it counter-clockwise (Fig. 9).
6. Remove the electronics module with the optical chamber (Fig. 10).
7. Remove the element with the thermistor from the optical chamber cover (Fig. 11).
8. Release the mounting catch (Fig. 12) and remove the optical chamber cover (Fig. 13).

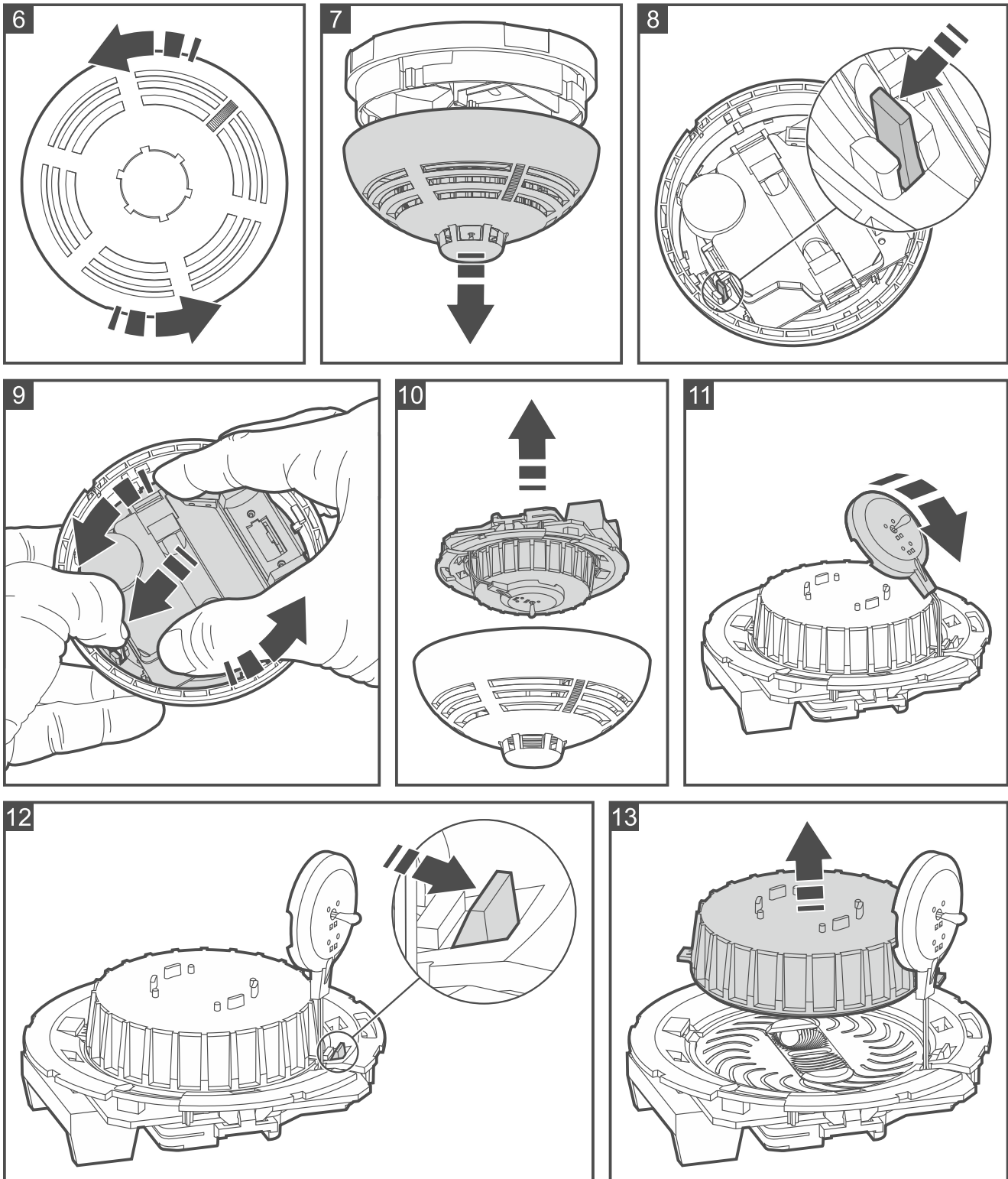

9. Using a soft brush or compressed air, clean the labyrinth in the cover, as well as the base of the optical chamber. Pay attention to the recesses where LEDs are installed.
10. Replace the cover of the optical chamber.
11. Replace the element with the thermistor on the optical chamber.
12. Secure the electronics module with the optical chamber in the cover and turn it clockwise.
13. Re-install the battery.
14. Replace the detector cover and lock it with a screw.
15. Press the test / reset button (Fig. 1). Fire alarm should be triggered.
16. Press again the test / reset button to clear the alarm.

## 7 Battery replacement



**The used batteries must not be discarded, but should be disposed of in accordance with the existing rules for environment protection.**

When the detector indicates low battery (3 short flashes of the LED indicator and 3 short beeps every 30 seconds), the battery must be replaced.

1. Start the service mode in the control panel (if the controller is connected to a SATEL alarm control panel).
2. Remove the cover locking screw.
3. Turn the cover counter-clockwise (Fig. 6) and remove it (Fig. 7).
4. Remove the discharged battery.
5. Install a new CR123A 3 V lithium battery.
6. Replace the detector cover and lock it with a screw.
7. Press the test / reset button (Fig. 1). Fire alarm should be triggered.
8. Press again the test / reset button to clear the alarm.

## 8 Specifications

Operating frequency band .....866 MHz / 868.0 MHz ÷ 868.6 MHz / 915 MHz – 928 MHz

Radio communication range (in open area)

ABAX 2

ACU-220 ..... up to 2000 m

ACU-280 ..... up to 1200 m

ABAX..... up to 500 m

Battery ..... CR123A 3 V

Battery life expectancy ..... up to 2 years

Standby current consumption .....30 µA

Maximum current consumption .....50 mA

Static response temperature ..... 54°C

Operating temperature range..... 0°C...55°C

Maximum humidity ..... 93±3%

Dimensions ..... ø108 x 61 mm

Weight..... 172 g