

abax2

Wireless dual technology motion detector

APMD-250

Firmware version 1.02

EN

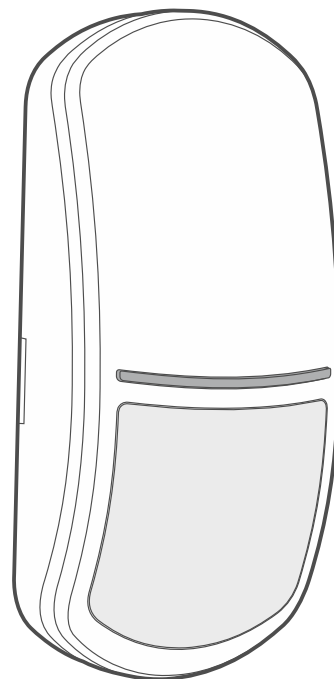

CE

apmd-250_en 02/23

Satel  [®]

SATEL sp. z o.o. • ul. Budowlanych 66 • 80-298 Gdańsk • POLAND
tel. +48 58 320 94 00
www.satel.pl

IMPORTANT

The device should be installed by qualified personnel.

Prior to installation, please read carefully this manual.

Changes, modifications or repairs not authorized by the manufacturer shall void your rights under the warranty.

The rating plate of the device is located on the enclosure base.

 The device meets the requirements of the applicable EU directives.



The device is designed for indoor installation.



The device must not be disposed of with other municipal waste. It should be disposed of in accordance with the existing rules for environment protection (the device was placed on the market after 13 August 2005).

 The device meets the technical regulations of the Eurasian Customs Union.

SATEL aims to continually improve the quality of its products, which may result in changes in their technical specifications and software. Current information about the changes being introduced is available on our website.

Please visit us at:
<https://support.satel.pl>

Hereby, SATEL sp. z o.o. declares that the radio equipment type APMD-250 is in compliance with Directive 2014/53/EU. The full text of the EU declaration of conformity is available at the following internet address: www.satel.pl/ce

In the EU, this radio equipment is only permitted to operate in the 868 MHz frequency band.

The following symbols may be used in this manual:



- note,



- caution.

CONTENTS

1	Features	2
2	Specifications	2
3	Description	3
	Radio communication	3
	Alarms	3
	Operating modes	3
	Energy saving mode (ECO)	4
	Test mode	4
	LEDs	4
	Supervision of motion detection system	4
	Battery status control	4
	Electronics module	5
4	Installation	5

The APMD-250 detector detects movement in a protected area. It is designed for operation within the ABAX 2 / ABAX two-way wireless system. This manual applies to the detector with firmware version 1.02, which is supported by:

- ABAX 2:
 - ACU-220 / ACU-280 controller,
 - ARU-200 repeater.
- ABAX:
 - ACU-120 / ACU-270 controller (firmware version 5.04 or newer),
 - ARU-100 repeater (firmware version 2.02 or newer),
 - INTEGRA 128-WRL control panel (firmware version 1.19 or newer and firmware version of processor used to operate ABAX system 3.10 or newer).

1 Features

- Motion detection with two sensors: passive infrared sensor (PIR) and microwave sensor (MW).
- Adjustable detection sensitivity of both sensors.
- Digital motion detection algorithm for both sensors.
- Digital temperature compensation.
- Capability of separate sensor testing.
- Option to enable / disable the creep zone protection.
- Ability to replace the lens with a curtain or long-range one.
- Encrypted two-way radio communication in the 866 MHz / 868 MHz / 915 MHz frequency band (AES standard for the ABAX 2 system).
- Transmission channel diversity – 4 channels for automatic selection of the one that will enable transmission without interference with other signals in the 866 MHz / 868 MHz / 915 MHz frequency band (ABAX 2 system only).
- Remote update of detector firmware (ABAX 2 system only).
- Remote configuration.
- Built-in temperature sensor (temperature measurement range from -10°C to +55°C).
- LED indicators.
- Supervision of motion detection system.
- “ECO” option for longer battery life (ABAX 2 system only).
- Battery status control.
- Tamper protection against enclosure opening and removal from mounting surface.
- Adjustable mounting bracket included.

2 Specifications

Operating frequency band.....866 MHz / 868.0 MHz ÷ 868.6 MHz / 915 MHz – 928 MHz

Radio communication range (in open area)

ABAX 2

ACU-220 up to 2000 m

ACU-280 up to 1600 m

ABAX..... up to 500 m

Battery	CR123A 3 V
Battery life expectancy.....	up to 2 years
Temperature measurement range	-10°C...+55°C
Temperature measurement accuracy	±1°C
Standby current consumption	75 µA
Maximum current consumption	13 mA
Microwave frequency	24.125 GHz
Detectable speed.....	0.3...3 m/s
Warm-up period	40 s
Recommended installation height.....	2 m...2.4 m
Coverage area	15 m x 24 m, 90°
Complied with standards.....	EN 50131-1, EN 50130-4, EN 50130-5
Security grade according to EN 50131-2-4 (detector mounted directly to the wall)	Grade 2
Environmental class according to EN 50130-5	II
Operating temperature range.....	-10°C...+55°C
Maximum humidity	93±3%
Dimensions	62 x 137 x 42 mm
Weight.....	152 g

3 Description

Radio communication

The detector connects to the controller / control panel at regular time intervals to provide information about its state (periodical communication). Additional communication may take place as a result of alarm (see “Operating modes”).

Alarms

The detector will report alarm:

- after detecting a motion in the protected area by both sensors within a time period shorter than 5 seconds (this alarm can only be reported in the active mode – see “Operating modes”),
- after detecting a fault in the motion detection system,
- after opening the tamper switch (tamper alarm).

Operating modes

Active – information about tamper alarm and motion detection alarm is sent immediately.

The microwave sensor is enabled after motion is detected by the infrared sensor.

Passive – only information about tamper alarm is sent immediately. The microwave sensor is disabled, therefore no alarm can be triggered after motion is detected. During periodical communication, information on whether the PIR sensor detects motion is sent.

This operating mode prolongs the battery life.

The detector operating mode is turned on remotely. If the detector is used in the INTEGRA / VERSA / PERFECTA 64 M alarm system, the operating mode may depend on the partition state (partition disarmed – passive mode; partition armed – active mode). For more information, refer to the ABAX 2 / ABAX controller manual / the INTEGRA 128-WRL control panel manual.

Energy saving mode (ECO)

If you want to prolong the battery life, you can enable in the detector the “ECO” option. When the “ECO” option is enabled, the periodical communication takes place every 3 minutes. Thus the battery life can be increased as much as fourfold. The option is only available in the ABAX 2 system. The detector with “ECO” option enabled meets requirements of the EN 50131-2-4 standard for Grade 2.

Test mode

The test mode makes the detector testing easier, because the LED indicators are enabled. How to start and end the test mode is described in the ABAX 2 / ABAX controller manual / the INTEGRA 128-WRL control panel manual.



After starting the test mode, automatic calibration of the microwave sensor is carried out. For 10 seconds after the test mode is started, there should be no moving object in the detection area of the microwave sensor, as this will prevent proper calibration of the sensor.

LEDs

The LEDs are flashing for about 40 seconds from inserting the battery, thus signaling the warm-up of the detector. The LEDs also work in the test mode, in which they indicates:

- periodical communication – short flash (80 milliseconds),
- motion detection – ON for 2 seconds.

Supervision of motion detection system

When the motion detection system starts malfunctioning, the detector will report an alarm during periodical communication. The alarm will keep going until the fault is cleared (long violation).

Battery status control

When the battery voltage is below 2.75 V, information about low battery is sent during each transmission.



In response to the battery voltage drop below 2.75 V, sensitivity of sensors in the detector is automatically lowered to eliminate false alarms.

When replacing the battery, wait about 1 minute between removing the old battery and installing the new one.

Electronics module



Do not remove the plastic cover from the circuit board to prevent damage to the components located on the board.

Do not touch the pyroelectric sensor, so as not to soil it.

- ① CR123A lithium battery.
- ② microwave sensor.
- ③ LED indicator.
- ④ element not used.
- ⑤ tamper switch activated by cover removal.
- ⑥ PIR sensor (dual element pyrosensor).

On the other side of the electronics module is a tamper switch activated by removing the detector from the wall.

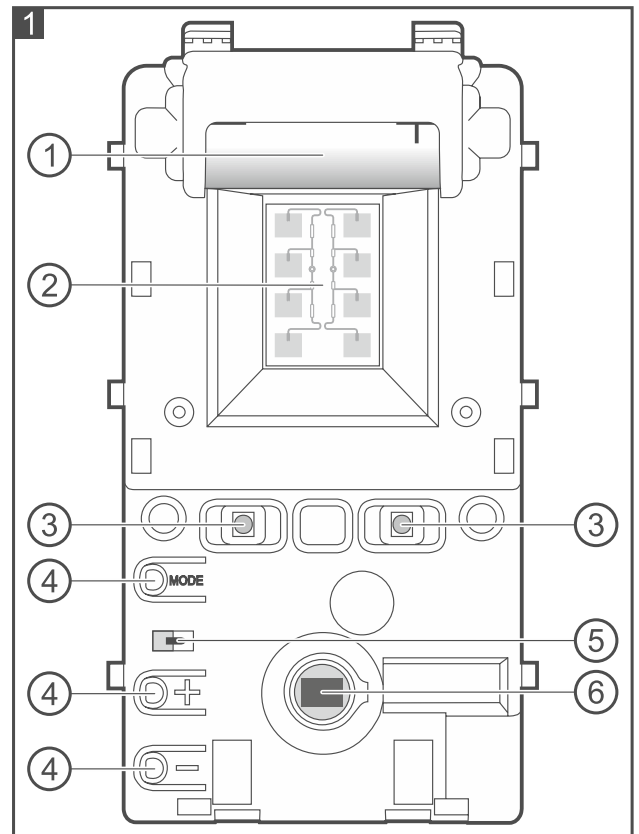

4 Installation

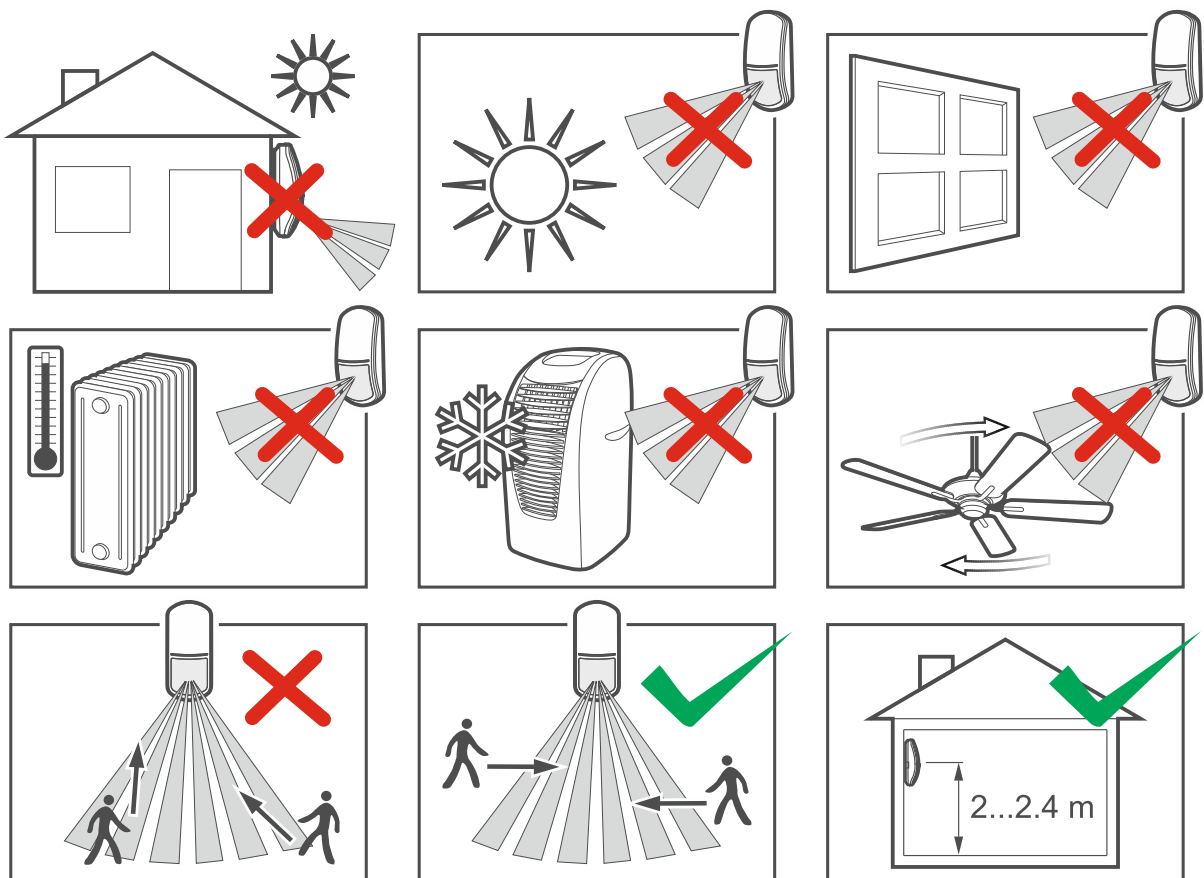

There is a danger of battery explosion when using a different battery than recommended by the manufacturer, or handling the battery improperly. Do not

crush the battery, cut it or expose it to high temperatures (throw it into the fire, put it in the oven, etc.).

Do not expose the battery to very low pressure due to the risk of battery explosion or leakage of flammable liquid or gas.

Be particularly careful during installation and replacement of the battery. The manufacturer is not liable for the consequences of incorrect installation of the battery.

The used batteries must not be discarded, but should be disposed of in accordance with the existing rules for environment protection.

1. Remove the front cover (Fig. 2).
2. Move the electronics module down to unlock it, and then remove it from the enclosure base (Fig. 3).
3. Install the battery and add the detector to the wireless system (see the ABAX 2 / ABAX controller manual or the INTEGRA 128-WRL control panel installer manual). The sticker with serial number which shall be entered when registering the detector in the system can be found on the electronics module.



In the INTEGRA / VERSA alarm system, the detector is identified as APMD-150.

Simultaneous operation of the detector by the ABAX 2 and ABAX controller / INTEGRA 128-WRL alarm control panel is not possible.

4. Place the electronics module in the enclosure base and then move it up to lock it.
5. Replace the cover.

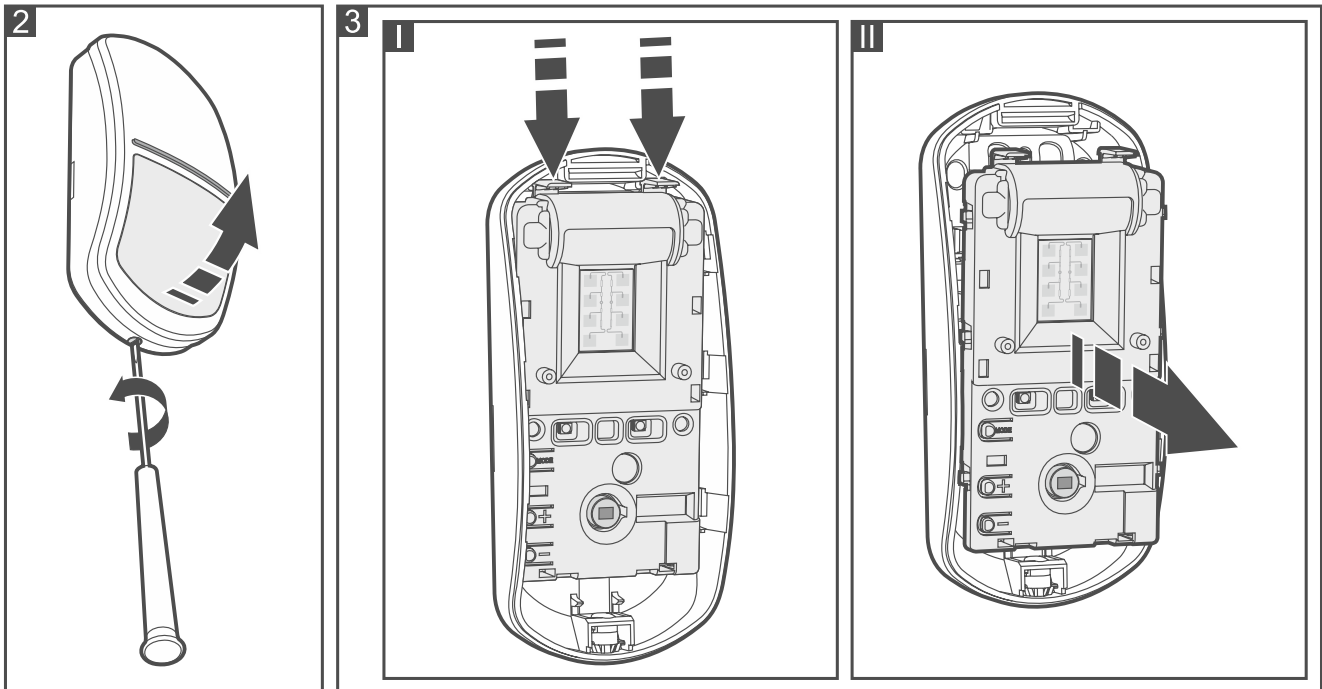

6. Put the detector at the place of its future installation.
7. Check the level of signal received from the detector by the ABAX 2 / ABAX controller or the INTEGRA 128-WRL control panel. If the signal level is lower than 40%, select another place for installation. Sometimes, it is sufficient to shift the device ten or twenty centimeters.

i The ARF-200 tester makes it possible to check the radio signal strength at the place of future installation without having to put the detector there.



8. Remove the front cover (Fig. 2) and remove the electronics module (Fig. 3).
9. Make screw holes in the enclosure base.
10. Secure the enclosure base to the wall (Fig. 4) or the bracket fastened with screws to the wall or ceiling (Fig. 5). The wall plugs (anchors) delivered with the device are intended for concrete, brick, etc. For other types of surface (drywall, styrofoam), use the appropriately selected wall plugs.

i If the detector is to comply with the EN 50131-2-4 requirements for Grade 2, do not install it on the mounting bracket (if installed on the bracket, the detector will comply with the standard requirements for Grade 1).

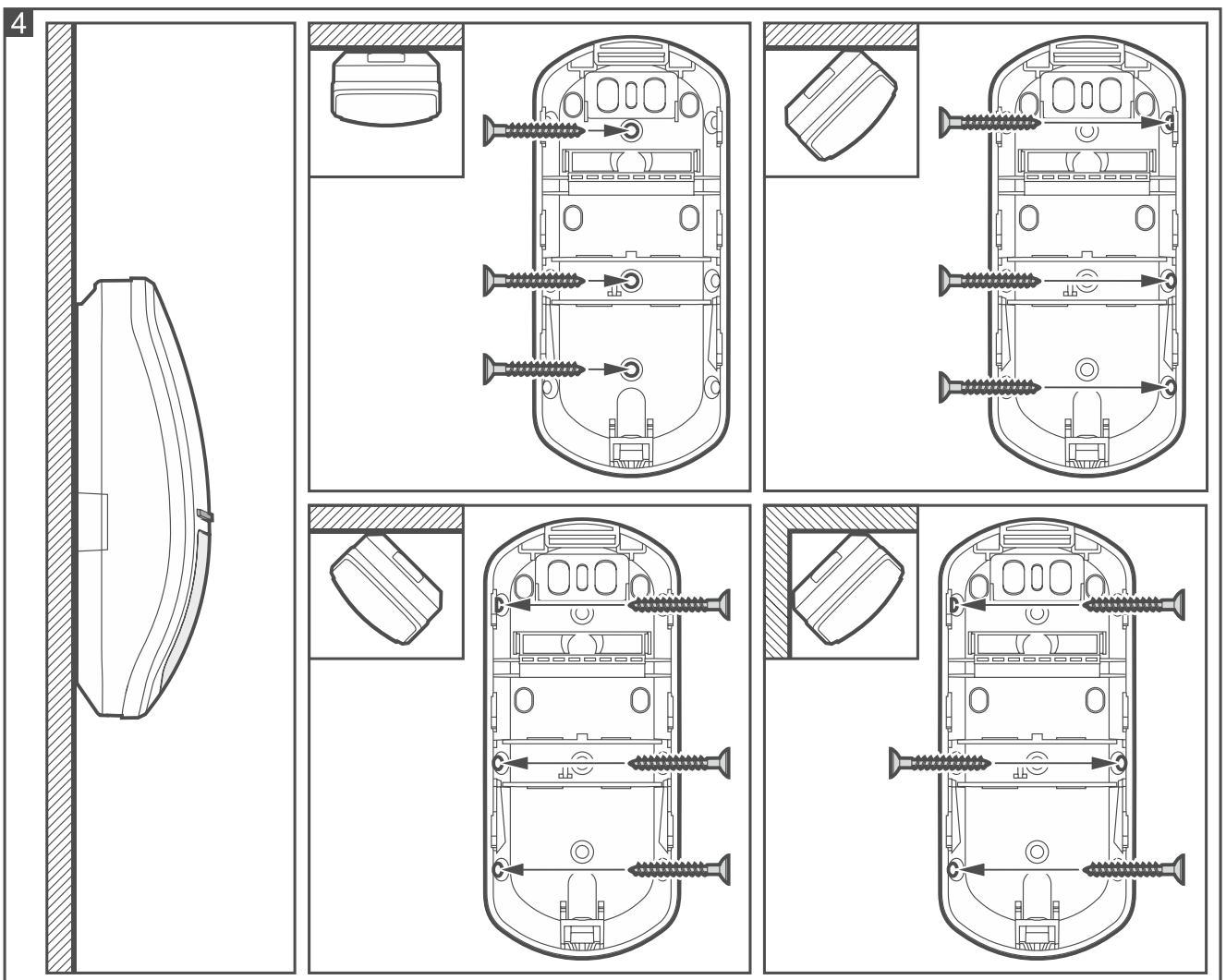
11. Fasten the electronics module in the enclosure.
12. If the detector is to protect the creep zone, the knob located on the inner side of the enclosure cover is to be set in position shown in Fig. 6-A. If the detector is NOT to protect the creep zone, set the knob to the position shown in Fig. 6-B.



13. Replace the cover.
14. Configure the detector settings (sensitivity of PIR sensor, sensitivity of microwave sensor, the way of operation in test mode, etc. – see the ABAX 2 / ABAX controller manual / the INTEGRA 128-WRL control panel manual).
15. Start the test mode (see the ABAX 2 / ABAX controller manual / the INTEGRA 128-WRL control panel manual).

16. Check whether moving around within the detector coverage area will get the LEDs to come on. Fig. 7 shows the maximum detection range  and the creep zone  of a detector placed at a height of 2.4 m.

i Fig. 7 shows the range of APMD-250 detector with the wide-angle (WD) Fresnel lens, which is installed in the detector as standard one. You can use the enclosure cover with another lens. The SATEL product range includes covers with the curtain (CT) lens as well as with the long-range (LR) lens.

17. End the test mode.

