

UWAGA

W przypadku montażu PK-1 na podłożu metalowym należy zastosować dystans minimum 10 mm

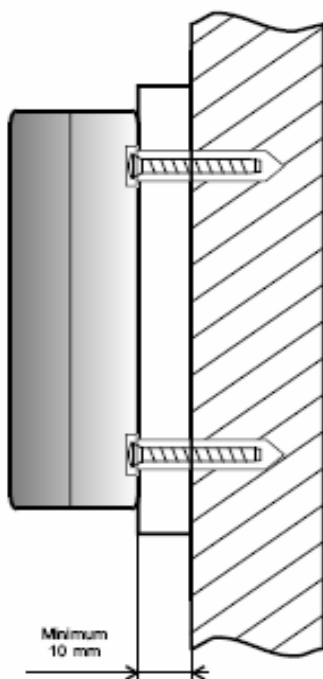

UWAGA

W przypadku montażu PK-1 na podłożu metalowym należy zastosować dystans minimum 10 mm.

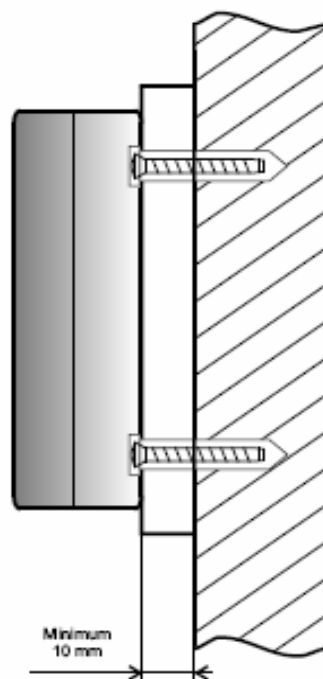

UWAGA

W przypadku montażu PK-1 na podłożu metalowym należy zastosować dystans minimum 10 mm

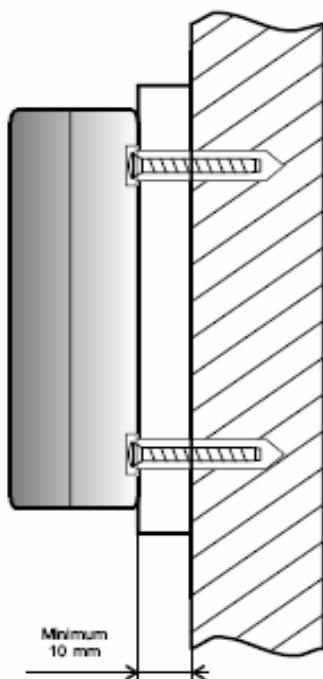

UWAGA

W przypadku montażu PK-1 na podłożu metalowym należy zastosować dystans minimum 10 mm

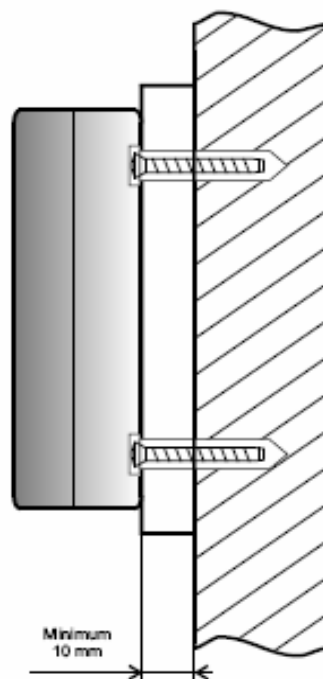

WARNING

When a PK-1 is mounted on a metal surface, a distance between PK-1 and the surface should not be lower than 10 mm.

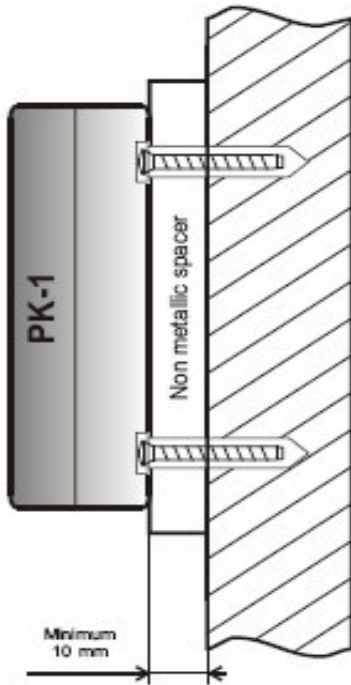

WARNING

When a PK-1 is mounted on a metal surface, a distance between PK-1 and the surface should not be lower than 10 mm.

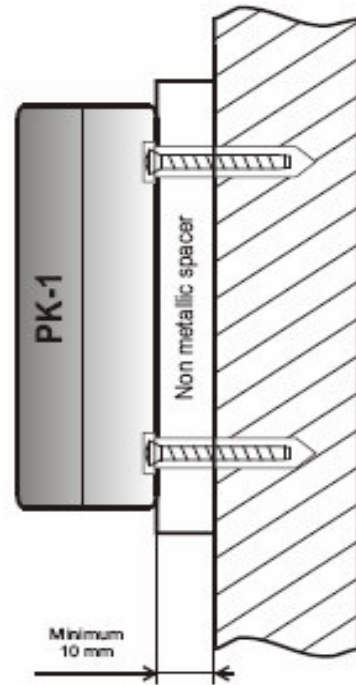

WARNING

When a PK-1 is mounted on a metal surface, a distance between PK-1 and the surface should not be lower than 10 mm.

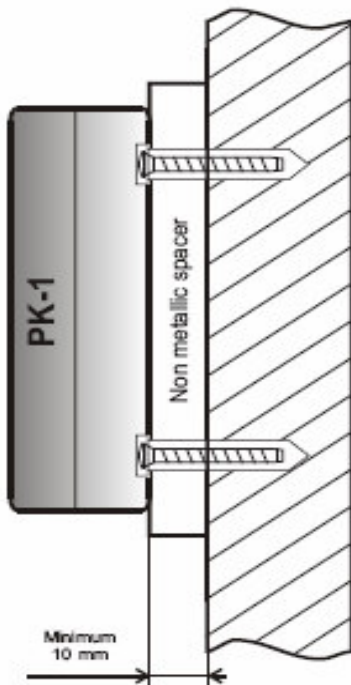

WARNING

When a PK-1 is mounted on a metal surface, a distance between PK-1 and the surface should not be lower than 10 mm.

