

Roger Access Control System

MCT80M / MCT82M / MCT84M Installation Manual

Firmware version: 1.1.6 and newer

Document version: Rev. B



This document contains minimum information that is necessary for initial setup and installation of the device. The detailed description of configuration parameters and functionalities is specified in respective Operating Manual available at www.roger.pl.

INTRODUCTION

The MCT reader is designed to operate in RACS 5 system as peripheral device connected to RS485 bus of MC16 access controller. Factory new reader is configured with default settings including ID=100 address. Before connecting to controller, the reader should be assigned with unoccupied address in range of 100-115. Programming of other parameters depends on the individual requirements and is not obligatory. Addressing of the reader can be done from computer by means of RogerVDM program or manually. Configuration of the reader with RogerVDM requires RUD-1 interface.

CONFIGURATION WITH ROGERVDM PROGRAM

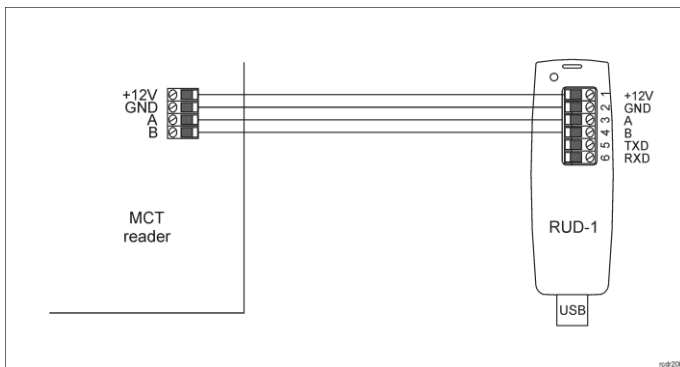

Fig. 1 Connection of MCT reader to RUD-1 interface for configuration

Programming procedure:

1. Connect the reader to RUD-1 interface (fig. 1) and connect the RUD-1 to computer's USB port.
2. Place jumper on MEM contacts (fig. 4).
3. Restart the reader (switch power supply off and on or short RST contacts for a moment) and orange LED SYSTEM will pulsate.
4. Start RogerVDM program, select *MCT* device, firmware version, *RS485* communication channel and serial port with RUD-1 interface.
5. Click *Connect*, the program will establish connection and will automatically display *Configuration* tab.
6. Enter unoccupied RS485 address in range of 100-115 and other settings according to requirements of specific installation.
7. Click *Send to Device* to update the configuration of reader.
8. Optionally make a backup by clicking *Send to File...* and saving settings to file on disk.
9. Remove jumper from MEM contacts and disconnect reader from RUD-1 interface.

Note: Do not read any cards nor press reader keypad when reader is configured with RogerVDM.

MANUAL ADDRESSING

Manual addressing procedure enables configuration of new RS485 address with all other settings unchanged.

Manual addressing procedure:

1. Remove all connections from A and B lines.
2. Place jumper on MEM contacts (fig. 4).
3. Restart the reader (switch power supply off and on or short RST contacts for a moment) and orange LED SYSTEM will pulsate.
4. Enter 3 digits of RS485 address in range of 100-115 with reader keypad or with any MIFARE card.
5. Remove jumper from MEM contacts and restart the reader.

Readers without keypad can be addressed with multiple card readings where the N number of readings emulates digit of the address. Three series of readings with any MIFARE proximity card are necessary to set the address. After each series wait for two beeps and proceed with the next digit. Zero digit is emulated with 10 readings.

Example:

Programming of ID=101 address with card readings:

1. Read card 1 time and wait for two beeps.
2. Read card 10 times and wait for two beeps.
3. Read card 1 time and wait for two beeps.
4. Wait till reader is restarted with the new address.

MEMORY RESET PROCEDURE

Memory reset procedure resets all settings to factory default ones including ID=100 address.

Memory reset procedure:

1. Remove all connections from A and B lines.
2. Place jumper on MEM contacts (fig. 4).
3. Restart the reader (switch power supply off and on or short RST contacts for a moment) and orange LED SYSTEM will pulsate.
4. Press [*] or read any MIFARE card 11 times.
5. Wait till reader confirms reset with long acoustic signal.
6. Remove jumper from MEM contacts and restart the reader.

FIRMWARE UPDATE

The update requires connection of reader to computer with RUD-1 interface (fig. 2) and starting RogerVDM software. The latest firmware file is available at www.roger.pl.

Firmware update procedure:

1. Connect the reader to RUD-1 interface (fig. 1) and connect the RUD-1 to computer's USB port.
2. Place jumper on FDM contacts (fig. 4).
3. Restart the reader (switch power supply off and on or short RST contacts for a moment).
4. Start RogerVDM program and in the top menu select *Tools* and then *Update firmware*.
5. In the opened window select device type, serial port with RUD-1 interface and path to main firmware file (*.hex) and in case of reader with keypad also path to additional firmware file (*.cyacd).
6. Click *Update* to start firmware upload with progress bar in the bottom.
7. When the update is finished, remove jumper from FDM contacts and restart the reader.

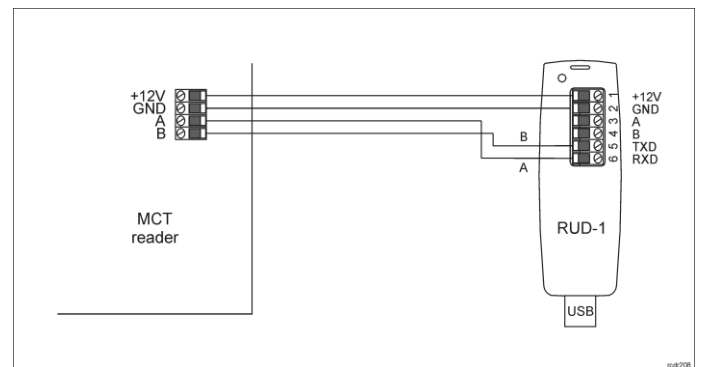

Fig. 2 Connection of MCT reader to RUD-1 interface for firmware update

APPENDIX

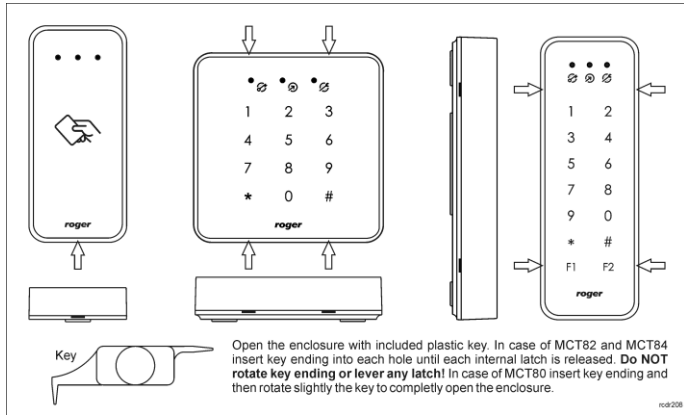

Fig. 3 Enclosure opening

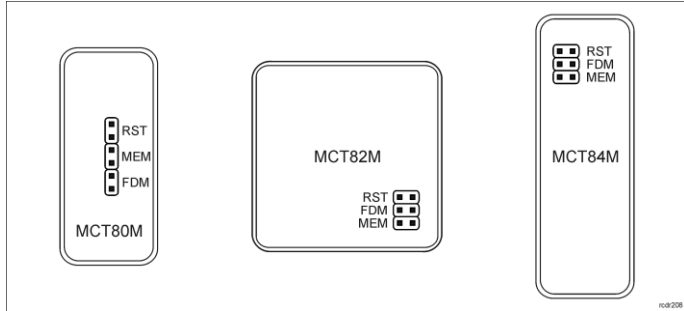

Fig. 4 Service contacts

Table 1. Screw terminals and wires		
Name	Wire colour (MCT80M)	Description
12V	Red	Supply plus
GND	Black	Ground
A	Yellow	RS485 bus, line A
B	Green	RS485 bus, line B
IN1		IN1 input line
IN2		IN2 input line
IN3		IN3 input line
IO1		IO1 output line
IO2		IO2 output line
NC		REL1 relay output (NC)
COM		REL1 relay common terminal
NO		REL1 relay output (NO)

Table 2. Specification	
Supply voltage	Nominal 12VDC, min./max. range 10-15VDC
Current consumption (average)	MCT80M: ~60 mA MCT82M/MCT82M-IO: ~60 mA MCT82M-BK/MCT82M-BK-IO: ~45 mA MCT84M: ~65 mA MCT84M-BK: ~50 mA
Inputs	Three parametric inputs (IN1..IN3) internally connected to the power supply plus through a 5.6kΩ resistor. Approx. 3.5V triggering level for NO and NC inputs.
Relay output	Relay output (REL1) with single NO/NC contact, 30V/1.5A DC/AC max. load
Transistor outputs	Two (IO1, IO2) open collector outputs, 15VDC/1A max. load
Tamper protection	Enclosure opening reported to access controller
Proximity cards	13.56MHz MIFARE Ultralight, Classic
Reading range	Up to 7 cm
Distance	1200m maximal cable length for RS485 bus between controller and reader
IP Code	MCT80M series: IP65 MCT82M/MCT84M series : IP41
Environmental class (according to EN 50133-1)	MCT80M: Class IV, outdoor general conditions, temperature: -25°C to +60°C, relative humidity: 10 to 95% (no condensation) MCT82M/MCT84M series: Class II, indoor general conditions, temperature: -10°C to +50°C, relative humidity: 10 to 95% (no condensation)
Dimensions H x W x D	MCT80M series: 100 x 45 x 16 mm MCT82M series: 85 x 85 x 22 mm MCT84M series: 130 x 45 x 22 mm
Weight	MCT80M: ~100g MCT82M series: ~100g

Certificates	MCT84M series: ~100g CE
--------------	----------------------------

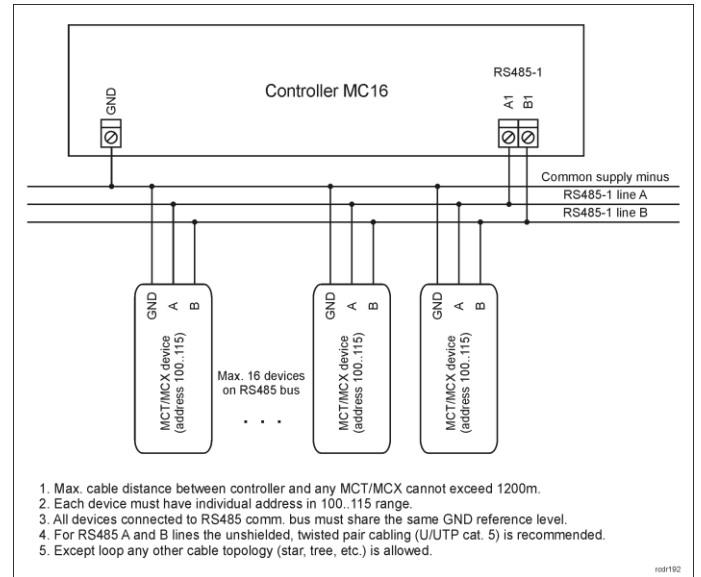

Fig. 5 Connection of readers and expanders to MC16 access controller

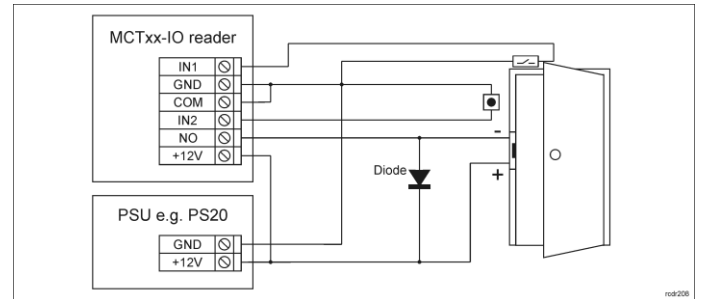
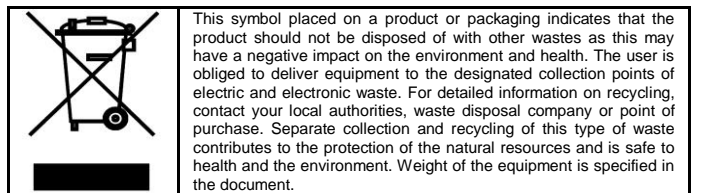

Fig. 6 Connection of door lock, door contact and exit button to MCTxx-IO reader



Contact:
Roger Sp. z o. o. sp. k.
82-400 Sztum
Gościszewo 59
Tel.: +48 55 272 0132
Fax: +48 55 272 0133
Tech. support: +48 55 267 0126
E-mail: biuro@roger.pl
Web: www.roger.pl