

The APS-524 power supply unit has been designed for use with 24 V DC electrical installations (e.g. access control systems). Due to application of an energy-efficient pulse power system, supplied directly from the mains with 230 V AC, the thermal losses have been minimized, while the reliability have been enhanced. The APS-524 has an input interference filter and a power factor compensation system, as well as short-circuit and overload protection.

Precision voltage control, microprocessor-based battery charge status control and automatic cut-off of the battery function in case of its excessive discharge, enable the battery to be used longer without any risk of being damaged. It is recommended that two series-connected 12 V lead batteries, 17 Ah capacity each, be used for operation with the APS-524.

The APS-524 is fitted with four LEDs, which indicate: the mains supply and battery condition, current overload, and excessive temperature rise. The detected troubles are signaled on the four OC type outputs and may be additionally signaled by the buzzer. During normal operation of the APS-524, the signaling outputs are shorted to ground (0V), but when a fault occurs, the respective output is cut off from the ground. The tamper contact, installed on the housing, makes it possible to include the APS-524 into the tamper circuit of the alarm system.

## 1. Power supply description

---

Four LEDs are provided on the power supply housing:

1  – **[MAINS]** (green):  
 ON – normal operation, with 230 V AC voltage present on the input,  
 OFF – no 230 V AC voltage or F1 fuse blown.

2  – **[BATTERY]** (green):  
 ON – battery voltage OK,  
 blinking – battery voltage drop below 22 V,  
 OFF – no battery or F3 fuse blown (6.3 A).

**Note:** *If there is no load at the power supply output, the  LED indication can be unstable. For a proper battery state indication, at least 200 mA load of the output is required.*

3  – **[OVERLOAD]** (yellow):  
 OFF – normal operation.  
 ON – current consumption in excess of 5 A.

4  – **[TEMPERATURE]** (red):  
 OFF – normal operation  
 blinking – elevated working temperature (above 45 °C) if there is no fan, or fan trouble (if the fan is installed).  
 ON – dangerous working temperature (above 65 °C), which may cause damage to the power supply unit.

The APS-524 construction enables to connect a fan, which ensures air circulation that decreases operation temperature. The fan should have an impulse output, which indicates its

correct operation. When power supply temperature reaches 45 °C, the processor turns on the fan and, if there is no proper fan rotation, the [TEMPERATURE] LED starts blinking. When the temperature reaches 65 °C the red [TEMPERATURE] LED goes on and the AWT output goes into active mode (disconnection from common ground). When the temperature drops below 65 °C the LED goes off, and when it drops below 45 °C the fan turns off.

In normal working condition (the room temperature of the environment) the usage of the fan is not necessary.

If the power supply output is shorted to the common ground (mount failure, cable fault) the power supply is turned off – all four LEDs start blinking. This situation lasts until the failure is removed. The short circuit may damage the F3 fuse in the battery circuit (if the battery was connected).

Explanations to Figure 2:

- 1 – **F1 mains fuse T3.15 A** – input circuit protection.
- 2 – **F3 fuse T6.3 A** – protection of battery charging circuit.
- 3 – **battery connecting cables** (red +; black -).
- 4 – **pins for setting power supply working parameters** – ● symbol on the electronics board denotes shorted pins (jumper on), ○ denotes open pins (jumper off). By default, jumpers are set on all pins.

**AC FAIL DELAY** – determination of the time that must elapse from the moment of AC supply failure to the moment of signaling the same on the AWS output (1800 or 10 seconds). By default, 1800 seconds.

**BATT. CHARGE** – determination of the battery charging current (1 A or 2 A). By default, 1 A.

**BATT. CHECK** – battery test enabled/disabled. Disabling the test does not disable the battery discharge control feature. By default, the battery test is enabled.

**BEEP** – audible trouble signal enabled/disabled. By default, the buzzer is enabled.

- 5 – **buzzer** – audible trouble signal.

- 6 – **FAN** – connector for connection of a typical 12 V fan (e.g. used in computers).

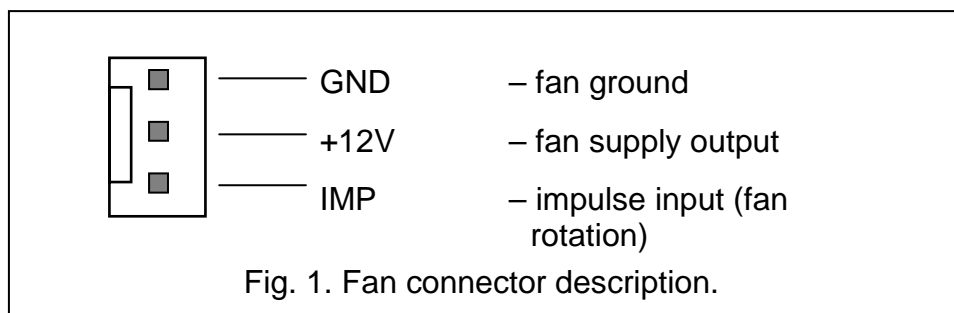

#### Description of terminals:

**230 and AC** – mains power supply inputs (230 V AC).

**+24V** – power supply outputs (27.2–27.6 V DC). Total current capacity of outputs 5 A.

**COM** – common ground (0V).

**AWT** – alarm output (OC): excessive permissible working temperature.

**AWB** – alarm output (OC): low battery voltage – below 22 V.

**AWP** – alarm output (OC): excessive permissible overload current – current consumption over 5 A.

**AWS** – alarm output (OC): loss of 230 V AC – output activation delay 1800 s or 10 s.

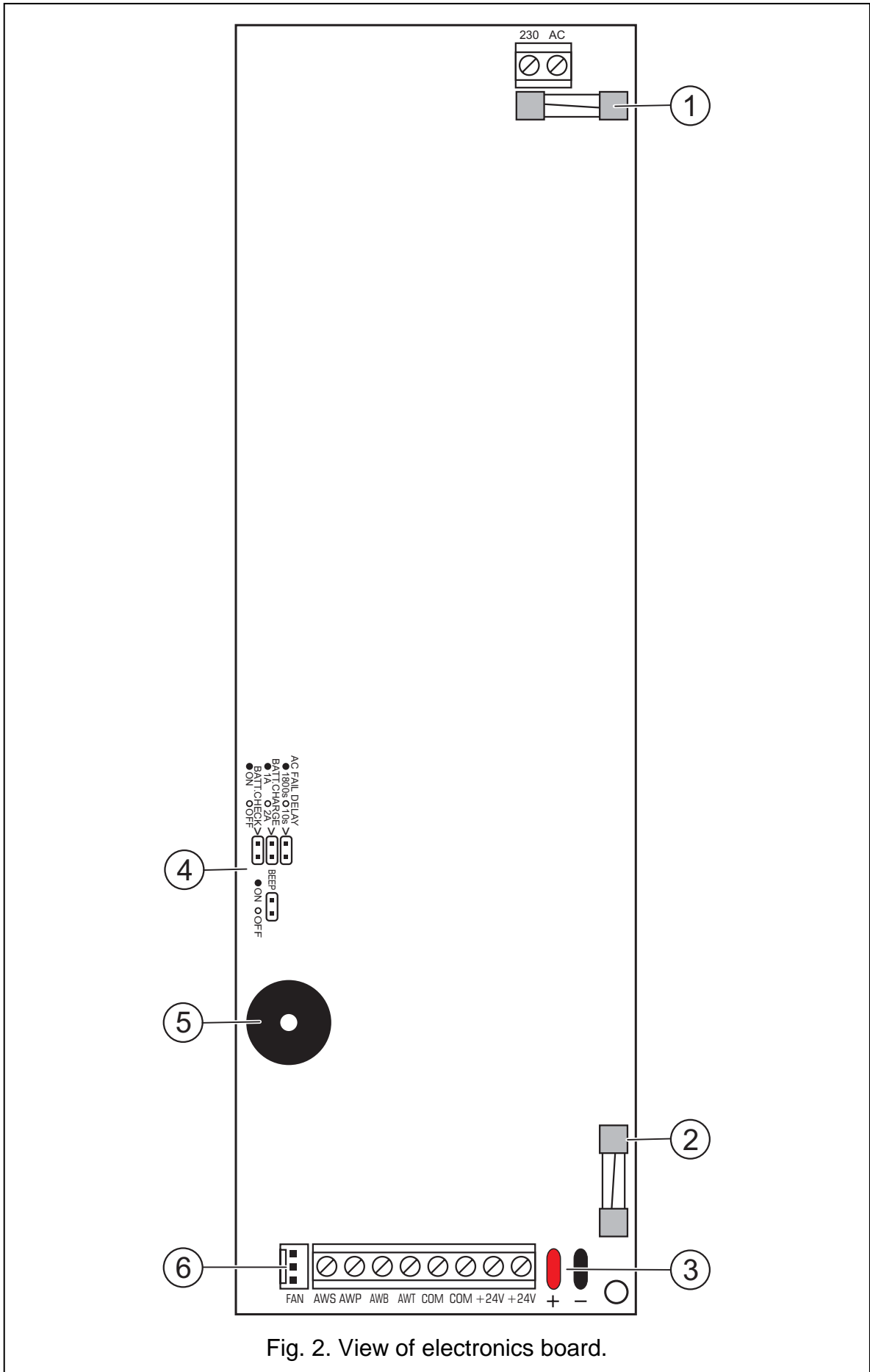

## 2. Installation

Prior to commencement of installation, load balance of the power supply should be drawn up. **The current derived from the APS-524 by external devices must not exceed 5 A.**

During operation, the APS-524 should be permanently connected to the mains supply. Therefore, get yourself familiar with electrical installation in the building before you proceed to making the cable connections. To supply the device, you should choose a circuit which is always alive and suitably protected.

The power supply should only operate while being permanently connected to mains supply. Hence, before making the connections it is necessary to familiarize with the electric system in the facility. For powering the device choose the circuit which is always live. The power supply circuit should be protected with a proper fuse.



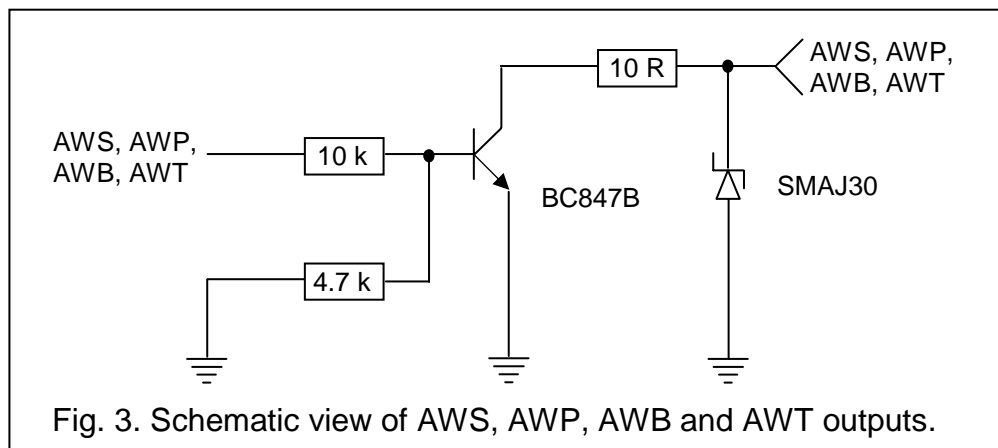

**Before connecting a device to the power supply circuit from which it will be powered, make sure the circuit is not alive.**

1. Attach the mounting (plastic) pins to the back side of the housing.
2. Mount the power supply housing in selected location and connect all electric leads .
3. Put the APS-524 board on the pins.
4. Fix the LED board to the housing lid with two steel sheet metal screws (green LEDs in upward position).
5. Connect the 230 V AC power wires to the 230 V and AC terminals of the APS-524. Connect the grounding wire to the terminal situated inside, on the rear panel of the metal housing and marked by the ground symbol .
6. Connect the supply cables for external devices to the terminals +24V and COM on the APS-524 board.
7. If necessary, make use of the trouble signaling outputs (e.g. to control relays or connect to the control panel zones).



8. By putting jumpers on the **AC FAIL DELAY** pins, set the time delay after which 230 V AC mains failure will be signaled on the AWS output. Possible time delay settings:
 





1800 seconds	–		Pins shorted
10 seconds	–		Pins open
9. Using the **BEEP** pins, determine, whether the buzzer is to signal troubles (jumper on), or not (jumper off).
10. Connect the batteries according to the color markings.  
The green LED  [BATTERY] lights up as soon as 230 V power supply is on, however the battery charge status will only be known after a full test, i.e. after approx. 12 minutes. The battery charge status check is performed every 4 minutes and lasts some ten to twenty

seconds. During the tests, the processor reduces the power supply voltage to approx. 21 V, and the loads are switched over to battery supply. If the battery voltage drops to approx. 22 V during three consecutive cycles, the APS-524 will report a trouble, and when the voltage drops down to 19 V, the APS-524 will disconnect the battery to prevent it from being fully discharged and damaged.

After completion of the test, the LED will remain ON if the APS-524 detects presence of a charged battery, or will start blinking if the battery is discharged, or will go out, if there is no battery supply.

**Note:** *If the battery is not detected after reconnection, the power supply circuit will only detect the presence of the battery on the AWB output when a full test is completed (approx. 12 min.).*

The battery test may be optionally disabled – to do so, remove the **BATT. CHECK** jumper. Disabling the test will also deactivate the battery trouble signaling on the AWB output, however it will not disable the circuit protecting the battery from complete discharge.

11. Switch on 230 V AC power supply (if all connections have been made properly, the LEDs  [MAINS] and  [BATTERY] should come on, while the LEDs  [OVERLOAD] and  [TEMPERATURE] should remain off).
12. Then, you can check the trouble control circuits for proper functioning (with BATT. CHECK jumper on):

**Disconnect mains supply** – the  [MAINS] LED will go out and the APS-524 will start audibly signaling the trouble. After the time set on the pins has elapsed, the AWS output status will change. After restoring the mains, the LED will come on with steady light, the sound will be muted, and – after expiry of the time set on the pins – the AWS output will stop signaling trouble.

**Disconnect battery** – after approx. 12 minutes the green  [BATTERY] LED will go out and the APS-524 will start audibly signaling the trouble. The AWB output will signal emergency condition. Reconnecting the battery will stop the trouble signaling by the LED indicator and buzzer after approx. 12 minutes.

When the APS-524 has been installed and tested for operation, its housing can be closed.



**As the APS-524 has no isolating switch to disconnect the mains supply, it is important that the user/owner of the device be advised on how it should be disconnected from the mains (e.g. by indicating the fuse which protects the supply circuit).**

### 3. Technical Data

Type of power supply unit .....	A
Supply voltage .....	230 V AC
Rated output voltage .....	24 V DC
Current capacity .....	5 A
Maximum battery charging current .....	1 A or 2 A
Energy efficiency .....	> 92%
Recommended battery .....	2 x 12 V/17 Ah
Load-carrying capacity, outputs: AWS, AWB, AWP, AWT (OC type) .....	max. 50 mA
Operating temperature range (Class I) .....	+5...+45 °C
Electronics board dimensions .....	233 x 73 mm
Housing dimensions .....	403 x 323 x 100 mm
Weight (without battery) .....	approx. 3.4 kg

#### WARNING

*This is a Class A device. It may cause radio interference in residential environment. In such cases, the user may be required to apply suitable countermeasures.*



**The control panel power supply unit has been designed for work with lead batteries or other batteries with a similar charging curve. Using any other batteries than recommended may cause a blow-up.**

The batteries, when used-up, must not be thrown away, but disposed of as required by the existing regulations (European Directives 91/157/EEC and 93/86/EEC).

The latest EC declaration of conformity and certificates are available for downloading on our website [www.satel.pl](http://www.satel.pl)



SATEL sp. z o.o.  
ul. Schuberta 79  
80-172 Gdańsk  
POLAND  
tel. + 48 58 320 94 00  
info@satel.pl  
www.satel.pl