

Roger Access Control System

User manual for CPR32-NET network controller

Firmware version: 1.0.14 or newer

Hardware version: 1.0

Document version: Rev. G



Contents

1. Introduction	3
1.1 This manual	3
2. Description and specification	3
3. Installation	4
3.1 Terminals and connection diagram	4
3.2 LED indicators	7
3.3 Power supply	7
3.4 Inputs and outputs	8
3.4.1 Inputs	8
3.4.2 Relay outputs	8
3.4.3 General purpose outputs	8
3.5 RS485 communication bus	8
3.5.1 Operation with PRxx1 and PRxx2 series access controllers	8
3.5.2 Integration with INTEGRA series alarm panels	9
3.6 Ethernet port	9
3.6.1 Integration with APERIO wireless door locks	9
3.7 Installation guidelines	9
4. Configuration	9
4.1 Configuration with web browser	9
4.2 Configuration with PR Master software	11
4.2.1 New subsystem with CPR32-NET	11
4.2.2 CPR32-NET options	12
4.3 CPR32-NET operation with memory card	17
4.4 Secure communication with CPR32-NET	18
4.4.1 Encrypted communication	18
4.4.2 Communication with CPR32-NET from dedicated host	19
4.5 Memory Reset	19
4.6 Firmware update	19
5. Ordering information	20
6. Product history	20

1. INTRODUCTION

1.1 This manual

This manual contains minimum information that is necessary to properly install CPR32-NET network controller within RACS 4 access control system. Full functional description of RACS 4 system and PR Master software is specified in following documents which are available at www.roger.pl:

- Functional description of PRxx2 series controllers
- Functional description of PRxx1 series controllers
- PR Master User manual

CPR32-NET can be applied in integrations with intruder alarm panels of INTEGRA series made by SATEL, with wireless door locks of APERIO system made by ASSA ABLOY. All integrations are described in dedicated documents which are available at www.roger.pl.

2. DESCRIPTION AND SPECIFICATION

CPR32-NET network controller is a successor to CPR32-SE network controller and it enables enhancement of RACS 4 access control system with following functionalities:

- events recording in central memory buffer
- configuration of antipassback zones (Global APB) in access control system
- concurrent arming/disarming of access controllers within particular alarm zone
- configuration of schedules and calendars (concerns PRxx1 series controllers)
- integration with wireless door locks APERIO (ASSA ABLOY) system
- integration with intruder alarm panels of INTEGRA series (SATEL)
- time synchronization with NTP server

The network controller is equipped with two RS485 ports which are used for communication with access controllers and for integration with INTEGRA system. The communication with computer (PR Master software) is performed by means of Ethernet port and is secured with AES128 CBC encryption standard. Events from access control system are stored in internal memory buffer (max. 240 000 events) or on optional AX-9 memory card (30 millions events). CPR32-NET operates with maximum number of APERIO door locks (16 pcs.) or maximum number of Integra alarm zones (32 zones) based on license which can be purchased from Roger company.

Note: The CPR32-NET requires PR Master software in version 4.5.4 or newer.

Note: Default, free of charge licence for CPR32-NET enables operation with 2 door locks of APERIO system and 2 alarm zones of INTEGRA alarm panel.

Table 1. Specification	
Supply voltage	Nominal 18VAC, min./max. range 17-22VAC Nominal 12VDC, min./max. range 10-15VDC Nominal 24VDC, min./max. range 22-26VDC
Backup battery	13.8V/7Ah, charging current app. 300mA
Average current consumption	100 mA for 18VAC (excluding loads connected to AUX/TML term.)
Inputs	Eight (IN1...IN8) NO/NC inputs, electrically biased to +12V via 15kΩ resistor, triggering level approx. 3.5V
Relay outputs	Two (REL1, REL2) relay outputs with single NO/NC contact, 30V/1.5A
Transistor outputs	Six (OUT1...OUT6) open collector outputs, 15VDC/1A (for OUT1 and OUT2) and 15VDC/150mA for remaining outputs
Power supply outputs	Two power supply outputs: 12VDC/0.2A (TML) and 12VDC/1A (AUX)

RS485 ports	Two RS485 communication ports
Ethernet port	10BASE-T 10/100Mb communication port
Distances	Between CPR32-NET and controller (RS485): max. 1200m
Environmental class (acc. to EN 50131-1)	Class I, indoor general conditions, temperature: +5°C to +40°C, relative humidity: 10 to 95% (no condensation)
IP code	n/a
Dimensions H x W x D	72 x 175 x 30 mm
Weight	approx. 200g
Certificates	CE

3. INSTALLATION

3.1 Terminals and connection diagram

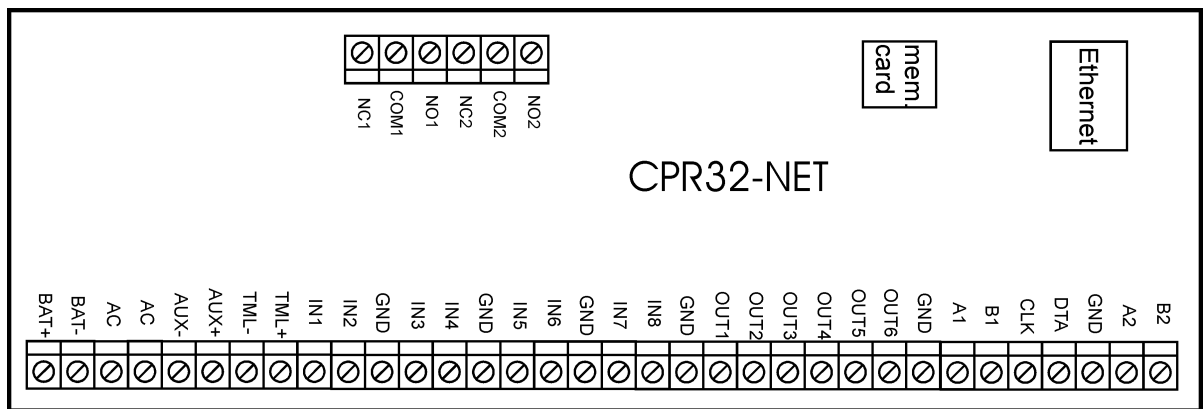

rcdr179

Fig. 1 CPR32-NET network controller board

Terminal	Description	Terminal	Description
NC1	REL1 relay output (NC)	IN5	IN5 input line
COM1	REL1 relay common terminal	IN6	IN6 input line
NO1	REL1 relay output (NO)	GND	Ground
NC2	REL2 relay output (NC)	IN7	IN7 input line
COM2	REL2 relay common terminal	IN8	IN8 input line
NO2	REL2 relay output (NO)	GND	Ground
BAT+	Backup battery	OUT1	OUT1 output line
BAT-	Backup battery	OUT2	OUT2 output line
AC	18VAC supply from transformer	OUT3	OUT3 output line
AC	18VAC supply from transformer	OUT4	OUT4 output line
AUX-	Built-in feeder output 12VDC/1A	OUT5	OUT5 output line
AUX+	Built-in feeder output 12VDC/1A	OUT6	OUT6 output line

TML-	Built-in feeder output 12VDC/0.2A	GND	Ground
TML+	Built-in feeder output 12VDC/0.2A	A1	RS485 -1 communication bus (controllers)
IN1	IN1 input line	B1	RS485-1 communication bus (controllers)
IN2	IN2 input line	CLK	not used
GND	Ground	DTA	not used
IN3	IN3 input line	GND	Ground
IN4	IN4 input line	A2	RS485-2 communication bus (integrations)
GND	Ground	B2	RS485-2 communication bus (integrations)

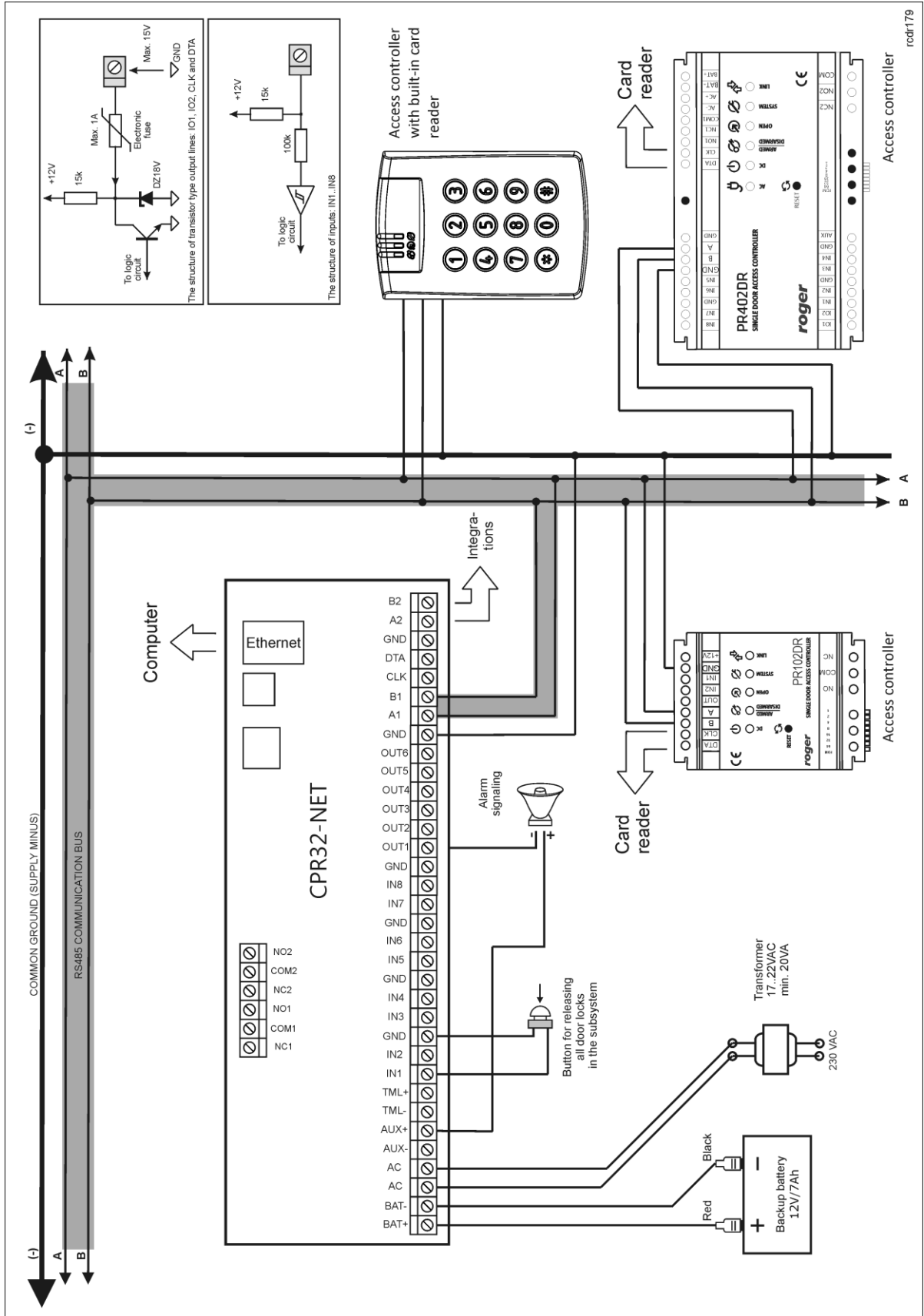

Fig. 2 Typical connection diagram of CPR32-NET

3.2 LED indicators

LED indicators are used for signalling various functions and actions conducted by CPR32-NET. In the table below all LED indicators are described.

LED 1: TAMPER	steady light – Tamper alarm activated (input line with function [02]: Tamper alarm was activated)
LED 2: CPR ON/OFF	steady light – CPR32-NET is on (by means of PR Master software) flashing light – CPR32-NET is off (by means of PR Master software)
LED 3: LOW BATTERY	steady light – low level of backup battery
LED 4: AC LOST	steady light – 18VAC power supply shortage
LED 5: BATTERY FAILURE	steady light – backup battery failure
LED 6: EVENT BUFFER	steady light – events buffer is full (the oldest events are being overwritten by the latest ones) flashing light – CPR32-NET events buffer is filled in 75%
LED 7: MEMORY CARD	steady light: memory card error or no card detected
LED 8: SYSTEM	steady light – firmware memory error infrequently flashing light – data memory error frequently flashing light – RTC error

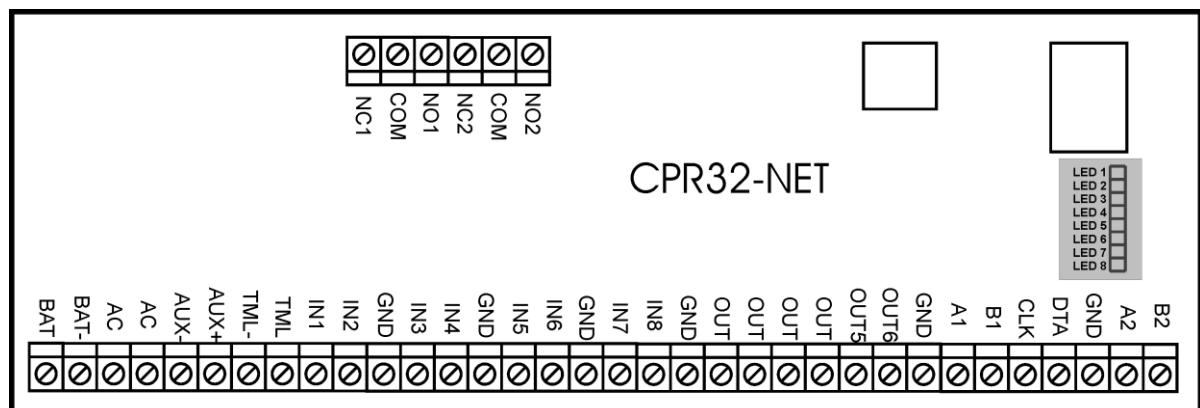

Fig. 3 LED indicators on CPR32-NET board

rcdr179

3.3 Power supply

Basically, CPR32-NET is designed for power supply from 230VAC/18VAC transformer with minimal power output 20VA, but it can also be supplied with 12VDC or 24VDC. The connection of power supply is shown in fig. 4.

If CPR32-NET network controller is supplied with 18VAC or 24VDC, then 12V backup battery can be connected in order to provide power supply in case of mains supply shortage.

CPR32-NET charges backup battery with 300 mA stabilized current up to 13.8V. Backup power supply is activated automatically in case of main powers supply shortage. If the voltage at backup battery drops below approx. 10V then the battery is automatically disconnected from CPR32-NET and remains disconnected until mains power supply returns. Depending on charging phase of backup battery, the voltage at AUX and TML terminals may vary in range of 11V (initial charging phase) to 13.8V (final charging phase) which is not a symptom of erroneous behaviour but it results from applied concept of battery charging.

In case of 12VDC power supply, backup battery cannot be directly connected to CPR32-NET and in such case backup power supply must be provided by 12VDC power supply unit. In case of maximal load at supply outputs AUX (1A) and TML (0.2A), the CPR32-NET requires 20W power output.

Note: The CPR32-NET cannot be started if it is supplied only from backup battery.

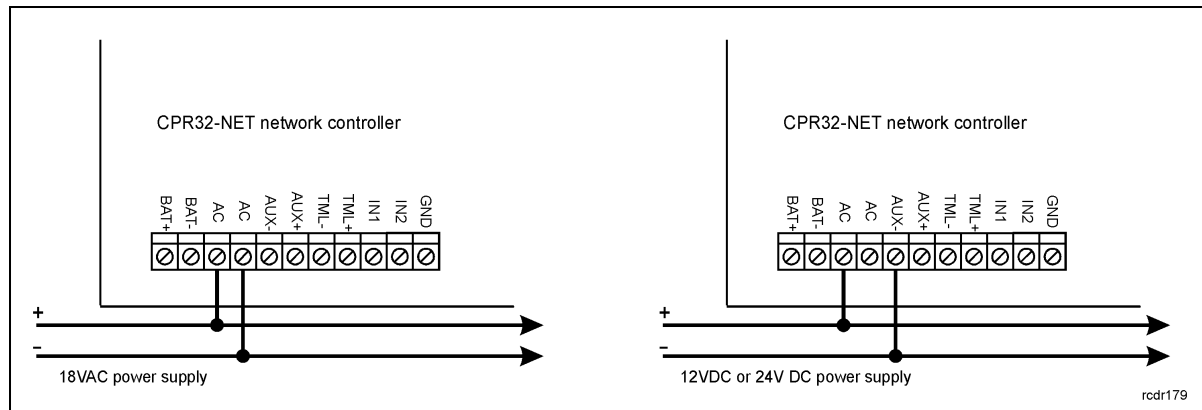

Fig. 4 Connection of CPR32-NET power supply

3.4 Inputs and outputs

Functions are assigned to inputs and outputs by means of PR Master software. Lists of available functions are specified in tables 4 and 5.

3.4.1 Inputs

All inputs (IN1...IN8) of CPR32-NET have identical electric structure and can be configured as NO or NC lines using PR Master software. The NO input is triggered by shorting it to supply minus (GND) while the NC input must be normally shorted to supply minus (GND) and it becomes triggered when connection with ground is interrupted. Every input is internally connected (pulled up) to the power supply plus (+12V) through a 15kΩ resistor.

3.4.2 Relay outputs

CPR32-NET network controller offers two relay type outputs (REL1, REL2), each with single switching contact rated 30V/1.5A. In the normal state (relay is off) the NC-COM contacts are shorted. In the triggering state (relay is on) the NO-COM contacts are shorted. In case of power outage, both relays remain in the off state.

3.4.3 General purpose outputs

CPR32-NET network controller offers six transistor outputs (OUT1...OUT6). All outputs are open collector type, i.e. in the normal (off) state they are pulled to supply plus via 15 kΩ resistor and when on, they short to supply minus. Maximum load for each output equals to 15VDC/1A. In case of overcurrent state, outputs are automatically switched off and CPR32-NET automatically restarts.

3.5 RS485 communication bus

CPR32-NET is equipped with two RS485 communication ports marked as RS485-1 and RS485-2. Each port includes two signal lines A and B which can be connected to RS485 communication bus. RS485-1 port is reserved for communication with PRxx1/PRxx2 series controllers, while RS485-2 port can be used in integration of access control system with alarm panel of INTEGRA (SATEL) series.

3.5.1 Operation with PRxx1 and PRxx2 series access controllers

PRxx1/PRxx2 series controllers are connected to CPR32-NET by means of two signal lines (A and B) which form communication bus of access control system. Such communication bus can be freely arranged in the form of star, tree or combination of aforementioned ones but it cannot be in the form of loop. The matching resistors (terminators) connected at the ends of RS485 transmitting lines are not required in RACS 4 system. In most cases communication works with any cable type

(standard telephone cable, shielded or unshielded twisted pair, etc.) but the recommended cable is unshielded, twisted pair (U/UTP cat.5). Shielded cables should be limited to installations subject to strong electromagnetic interferences. The RS485 communication standard used in the RACS 4 system guarantees proper communication in a distance of up to 1200 meters (counted as cable length from CPR32-NET to the furthest controller) as well as high resistance to interferences.

3.5.2 Integration with INTEGRA series alarm panels

CPR32-NET can operate with INTEGRA series alarm panels through INT-RS (SATEL) communication interface which is connected to RS485-2 port of CPR32-NET by means of RS232-RS485 converter (e.g. UT-2). The integration between access control system and alarm system enables synchronization of alarm zones in both systems. Therefore it is possible to arm/disarm alarm zones of INTEGRA system by means of readers in access control system and vice versa, i.e. arming and disarming of alarm zones in alarm system results in arming/disarming of associated alarm zones in access control system. Basically, up to 8 Integra alarm panels and up to 32 alarm zones can be integrated in RACS 4 system. More information on integration with INTEGRA series alarm panels is given in the document: Integration of RACS 4 and INTEGRA (SATEL) intruder alarm system.

3.6 Ethernet port

CPR32-NET is equipped with 10BaseT Ethernet port which is used for communication with computer (PR Master software) and other devices/systems in LAN/WAN. Communication with CPR32-NET and connected access controllers does not require additional communication interface and is performed by means of available Ethernet port.

Note: The operation of CPR32-NET in dedicated LAN is guaranteed by Roger. Practical tests proved that CPR32-NET can be also used in LAN, where multiple systems are operated as well as in WAN but in such case CPR32-NET functioning is not guaranteed by Roger due to number of possible and unpredictable network conditions.

3.6.1 Integration with APERIO wireless door locks

CPR32-NET can operate with ASSA ABLOY wireless door locks by means of APERIO hubs which are connected to CPR32-NET through LAN. Door locks from APERIO system are operated in RACS 4 as additional access controllers which means that CPR32-NET can operate 48 doors i.e. 32 doors with PR series single door controllers and 16 doors with APERIO system door locks. More information on integration with wireless door locks of APERIO system is given in the document: Integration of RACS 4 and APERIO (ASSA ABLOY) wireless lock system.

3.7 Installation guidelines

- Install devices in such way as to ensure easy access to screw terminals and jumpers.
- All electric connections must be made with power supply switched off.
- All devices connected to the same communication bus (RS485 and RACS Clock&Data) should be connected to the same negative potential (GND). Therefore all GND terminals from various power supply units used in the system should be connected with each other.
- Common supply minus (GND) of the entire system can be earthed however in one, arbitrary selected, point only.
- Positive terminals of power supply outputs cannot be shorted.

4. CONFIGURATION

4.1 Configuration with web browser

In order to communicate with CPR32-NET unit and use it within RACS 4 system it is necessary to know its IP address and port. Default parameters of CPR32-NET are as follows:

IP address=192.168.0.80
Subnet mask=255.255.255.0
Default gateway=192.168.0.1
Administrator login: admin

Administrator password: admin
UDP port = 3544
Events recorded in internal flash memory
Encrypted communication with default password

It is assumed that mentioned above parameters will be changed in particular access control installation, specifically IP address and administrator password. These parameters can be modified by means of CPR32-NET webpage (see fig 5) opened with web browser.

Note: In order to connect with CPR32-NET in local area network (LAN), the computer must be in the same subnet. In case of CPR32-NET with default IP address, the IP address of computer should be 192.168.0.xxx.



Fig. 5 CPR32-NET webpage in web browser

Following options are available on CPR32-NET web page:

Network

In this window following parameters of CPR32-NET can be modified

- IP address
- subnet mask
- UDP port
- and other communication parameters

Passwords

In this window administrator password as well as communication password for encrypted communication between CPR32-NET and computer with PR Master software can be modified. More information on encryption is given in paragraph 4.4.1 Encrypted communication.

Events buffer

In this window there is given information on CPR32-NET status and time, errors, selected buffer memory, maximum and current number of events in memory buffer.

Network Statistics

In this window some statistics regarding connection with CPR32-NET are available.

Firmware upgrade

In this window CPR32-NET firmware can be upgraded. More information is given in paragraph 4.6 Firmware update.

4.2 Configuration with PR Master software

After connection of CPR32-NET to access controllers within RACS 4 system and to computer in LAN/WAN, the installer can proceed with installation and configuration of PR Master software. CPR32-NET acts as central unit with event buffer and Ethernet-RS485 communication interface for communication with various devices in RACS 4 system, including access controllers.

4.2.1 New subsystem with CPR32-NET

In order to create new subsystem with CPR32-NET unit and to detect access controllers, it is necessary to select the option **Networks** in the main window of PR Master software and then click the button **Add network** (see fig. 6). In the newly opened window (see fig. 7) in the field **Communication port** select CPR32-NET, in the field **Server IP** enter IP address of CPR32-NET and in the field **Server Port** enter UDP port of CPR32-NET. In case of operation in the same LAN subnet, IP address and port of CPR32-NET can be automatically detected by PR Master software as in window shown in fig. 7.

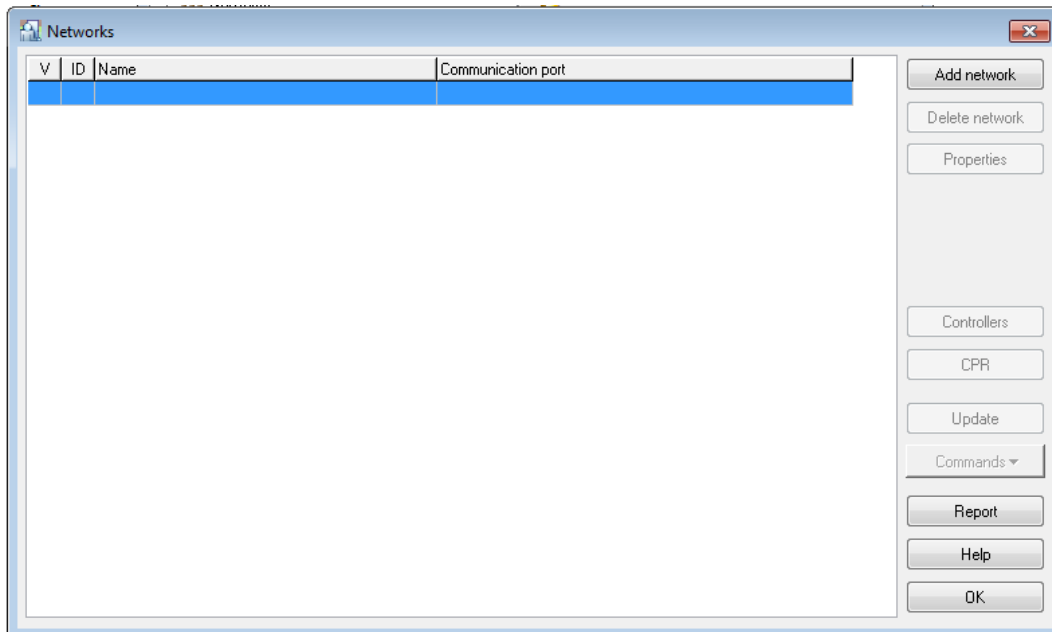

Fig. 6 Network window

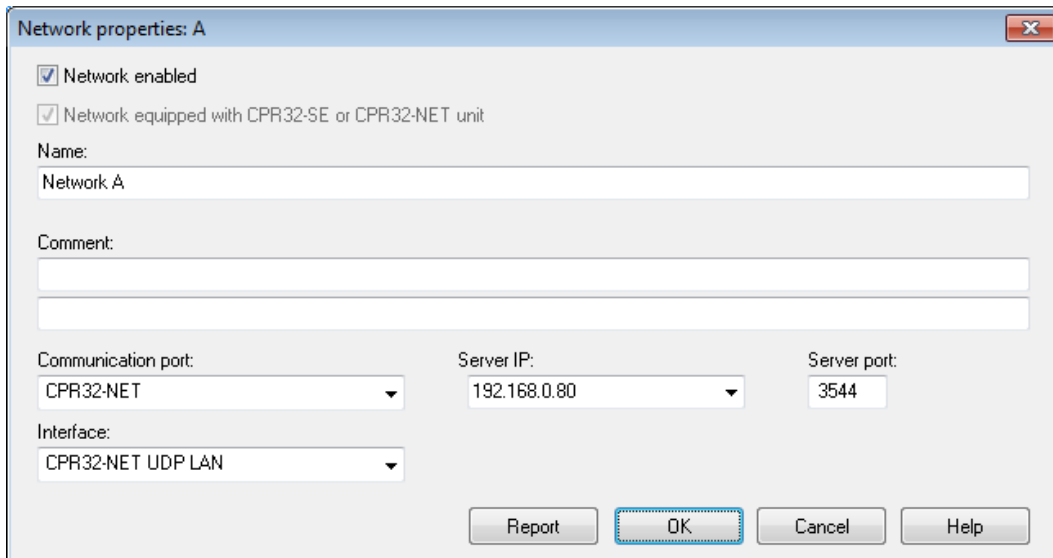

Fig. 7 Network properties window

In the next step close the window by means of **OK** button and in the window shown in fig. 6 click the button **Controllers**. In the newly opened window click the button **Add** in order to detect all controllers connected to RS485-1 bus of CPR32-NET. The maximum number of PR series access controllers connected to CPR32-NET equals to 32 units. Each controller connected to CPR32-NET must have unique address. Example of RACS 4 system consisting of two network (subsystem) is shown in fig. 8. Multiple CPR32-NET units forming multiple subsystems can operate within single RACS 4 system. Each CPR32-NET unit must have individual IP address but they can use the same UDP port.

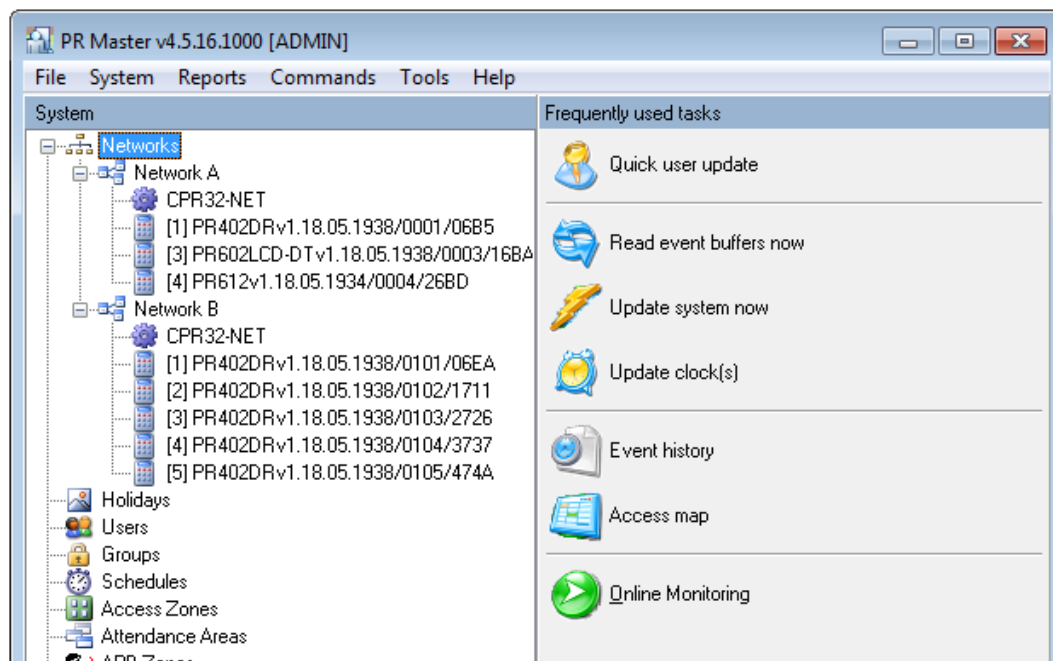

Fig. 8 Main window of PR Master software

4.2.2 CPR32-NET options

After detection of CPR32-NET unit and controllers connected to its RS485-1 bus, the CPR32-NET is ready for operation in typical RACS 4 system. It is possible to configure some additional options by clicking **CPR32-NET** option in the main window of PR Master software which results in opening

[09]	Set all doors to Unlocked mode	ON monitored	When the input is activated then Unlocked Door Mode is activated at all controllers (doors) within subsystem (network).
[10]	Set all doors to Cond. Unlocked mode	ON monitored	When the input is activated then Conditional Unlocked Door Mode is activated at all controllers (doors) within subsystem (network).
[11]	Set all doors to Locked mode	ON monitored	When the input is activated then Locked Door Mode is activated at all controllers (doors) within subsystem (network).
[12]	Clear all alarms in subsystem	ON monitored	When the input is activated then all alarms in CPR32-NET and controllers within particular subsystem (network) are cleared. The function [12] operates as a sum of [01] and [13] functions.
[13]	Clear alarms in all controllers	ON monitored	When the input is activated then all alarms in controllers within particular subsystem (network) are cleared.
[14]	Reset APB	ON monitored	When the input is activated then APB Register in subsystem is cleared.
[15]	Set Armed mode	ON monitored	When the input is activated then all alarm zones in subsystem and all controllers (doors) not assigned to alarm zones become armed.
[16]	Set Disarmed mode	ON monitored	When the input is activated then all alarm zones in subsystem and all controllers (doors) not assigned to alarm zones become disarmed.
[17]	Set all doors to Unlocked mode (momentary)	ON/OFF monitored	As long as the input is activated, Unlocked Door Mode is activated at all controllers (doors) within subsystem (network). When the input is deactivated then Normal Door Mode is restored at all controller (doors) within subsystem.

Menu: Configuration->Outputs

In the window opened by means of this option it is possible to assign functions to CPR32-NET transistor and relay outputs as well as specify their type. Output lines can be normal or inverted type. The list of available functions is shown in table 5.

Table 5. Output functions		
No.	Function	Description
[00]	None	Output line is not used.

[65]	External buzzer	<p>The output is dedicated to connection of external speaker in order to signal acoustically following alarms:</p> <ul style="list-style-type: none"> • firmware memory error – infinite, modulated signal (3 sec. of sound /3 sec. of pause) • configuration error – repeated double short acoustic signals • event memory error – repeated three short acoustic signals • RTC error – repeated four short acoustic signals • Tamper alarm or Power supply alarm – the signal is modulated (1 sec. of sound/ 1 sec. of pause) and lasts 3 minutes
[67]	Alarm in CPR - modulated	The output is activated for 3 minutes if Tamper Alarm or Power supply alarm is raised. The function [67] operates as a sum of [81] and [82] functions. The signal is modulated (1 sec. of signal/ 1 sec. of pause).
[71]	Alarm in subsystem (network)	The output is activated for 3 minutes if Tamper Alarm, Power supply alarm or any alarm in one of controllers is raised. The function [71] operates as a sum of [81], [82] and [72] functions.
[72]	Alarm in controllers	The output is activated for 3 minutes if any alarm is raised in one of PR series controllers within the subsystem (network).
[73]	Alarm in CPR	The output is activated for 3 minutes if Tamper Alarm or Power supply alarm is raised. The function [67] operates as a sum of [81] and [82] functions.
[74]	Low battery	The output remains activated as long as charge level of backup battery connected to CPR32-NET unit is low.
[75]	18VAC supply lost	The output is activated after 15 minutes of 18VAC power supply shortage to CPR32-NET unit and remains activated until the power supply is restored.
[76]	Battery failure	The output is activated in case of battery failure (no battery or internal damage of battery). If the output is activated then the battery must be checked by maintenance personnel. The output remains activated until the problem is eliminated.
[77]	CPR on	The output signals that CPR32-NET is switched on by PR Master software.
[78]	CPR off	The output signals that CPR32-NET is switched off by PR Master software.
[79]	Internal failure	The output is activated when internal testing detects RTC failure, firmware memory failure or data memory error. Internal test is performed every 20 minutes. The output is activated until the failure/error is removed.
[80]	Buffer alarm - modulated	The output is activated when the event memory buffer is full and remains activated until the buffer is cleared. The signal is modulated (1 sec. of signal/ 1 sec. of pause).
[81]	Tamper alarm	The output is activated for 3 minutes if anti-sabotage (tamper) alarm is raised. The alarm is raised when the input with function [02] is activated.

[82]	Power supply alarm	The output is activated for 3 minutes if problem with CPR32-NET power supply occurs. The function [82] is a sum of [74], [75] and [76] functions.
[83]	Communication lost	The output is activated as long as the communication with any PR series controller within particular subsystem (network) is lost.
[84]	Buffer alarm	The output is activated when the event memory buffer is full and remains activated until the buffer is cleared.
[85]	Buffer prealarm	The output is activated when the event memory buffer is filled in 75%.
[86]	Internal failure (3 min)	The output is activated for 3 minutes when internal testing detects RTC failure, firmware memory failure or data memory error. Internal test is started every 20 minutes.
[87]	Communication lost (3 min)	The output is activated for 3 minutes if the communication with any PR series controller within particular subsystem (network) is lost.
[88]	Buffer alarm (3 min)	The output is activated for 3 minutes when the event memory buffer is full.
[89]	Buffer prealarm (3 min)	The output is activated for 3 minutes when the event memory buffer is filled in 75%.
[90]	Low battery (3 min)	The output remains activated for 3 minutes if charge level of backup battery connected to CPR32-NET unit is low.
[91]	18VAC supply lost (3 min)	The output is activated for 3 minutes after 15 minutes of 18VAC power supply shortage to CPR32-NET unit.
[92]	Battery failure (3 min)	The output is activated for 3 minutes in case of battery failure (no battery or internal damage of battery). If the output is activated then the battery must be controlled by maintenance personnel.
[93]	Zone Armed	The output is activated as long as associated alarm zone is armed.

Menu: Configuration->Integra

In the window opened by means of this option it is possible to enable integration with INTEGRA alarm system. The integration is described in dedicated manual which is available at www.roger.pl.

Menu: Configuration->Time synchronization (NTP)

In the window opened by means of this option it is possible to enable time synchronization between CPR32-NET and NTP server. IP address of NTP server can be entered manually or selected from the list. NTP provides Coordinated Universal Time (UTC), therefore all time zones and daylight saving times are not included and have to be configured in CPR32-NET (e.g. select UTC+1:00 in the field **Time zone**).

If CPR32-NET is connected in LAN then port 123 must be forwarded at router in order to enable communication of CPR32-NET with NTP. If several CPR32-NET are installed in particular access control system then one of them can be connected with NPT, while the others can synchronize their clocks with mentioned CPR32-NET. In such case enter IP address of such CPR32-NET as if it was NTP server for remaining CPR32-NET units.

Menu: Configuration->Aperio

In the window opened by means of this option it is possible to enable integration with APERIO wireless door lock system. The integration is described in dedicated manual which is available at www.roger.pl.

Menu: Commands

Commands which are available within that option are used for control of CPR32-NET unit. Following commands are available:

- CPR ON/OFF
- Read CPR real time clock
- Set clock
- Number of events in CPR
- Read events buffer
- Clear events buffer
- Clear CPR alarm
- Read voltage
- CPR Restart
- Restore defaults

Menu: Tools->License

In the window opened by means of this option it is possible to verify current licence for CPR32-NET and read its serial number which is used for generating new license.

CPR32-NET with default license is limited to maximum 2 alarm zones in case of integration with INTEGRA alarm panels and to maximum 2 wireless door locks in case of integration with APERIO system. In order to increase these limits it is necessary to purchase license from Roger company and then copy license *.ini file to Licenses folder of PR Master software. Default path is C:\Roger\Access Control System 4.5\Licenses.

4.3 CPR32-NET operation with memory card

CPR32-NET is equipped with built-in memory buffer with capacity for 240 000 events. During normal operation of RACS 4 system all events can be automatically or manually uploaded to PR Master software. Such upload clears CPR32-NET memory buffer

There are situations when event buffer with greater capacity is required. It could results from very irregular manual downloading of events to PR Master or enormous generation of events in short time or because of backup requirements.

CPR32-NET network controller can operate with optional AX-9 memory card which can be purchased from Roger. Such card enables recording of 30 million events. The socket for card is shown in fig. 1 and it is located under CR2032 battery.

Switching between built-in flash memory and flash memory card in CPR32-NET can be done by means of the PR Master option which can be accessed in CPR32-NET properties i.e. PR Master->CPR32-NET->Configuration->Settings->Events buffer – see fig. 10.

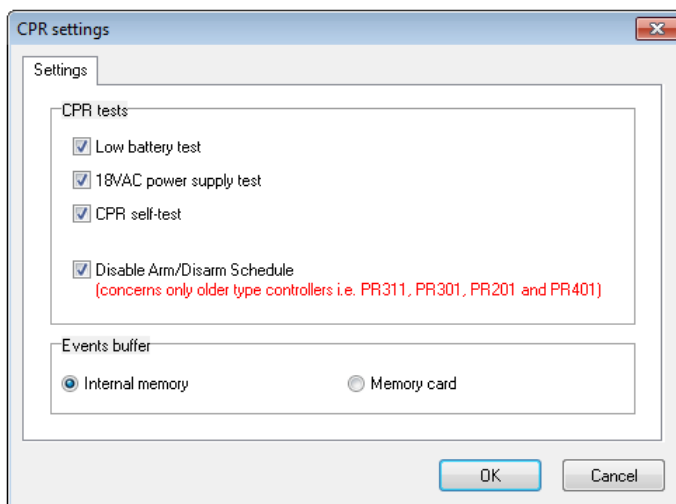

Fig. 10 Events buffer option

4.4 Secure communication with CPR32-NET

4.4.1 Encrypted communication

The communication between PR Master software and CPR32-NET as well as between CPR32-NET units in RACS 4 system unit is encrypted by means of AES128 CBC algorithm. By default null password (empty) is used but it is recommended to specify own communication password during configuration of CPR32-NET.

Communication password is defined by means of CPR32-NET webpage (menu: Passwords) where it must be entered into following fields: **Communication password** and **Retype communication password** –see fig. 11. Moreover the same password must be entered in PR Master software (menu: Tools->Options->CPR32-NET – see fig. 12).

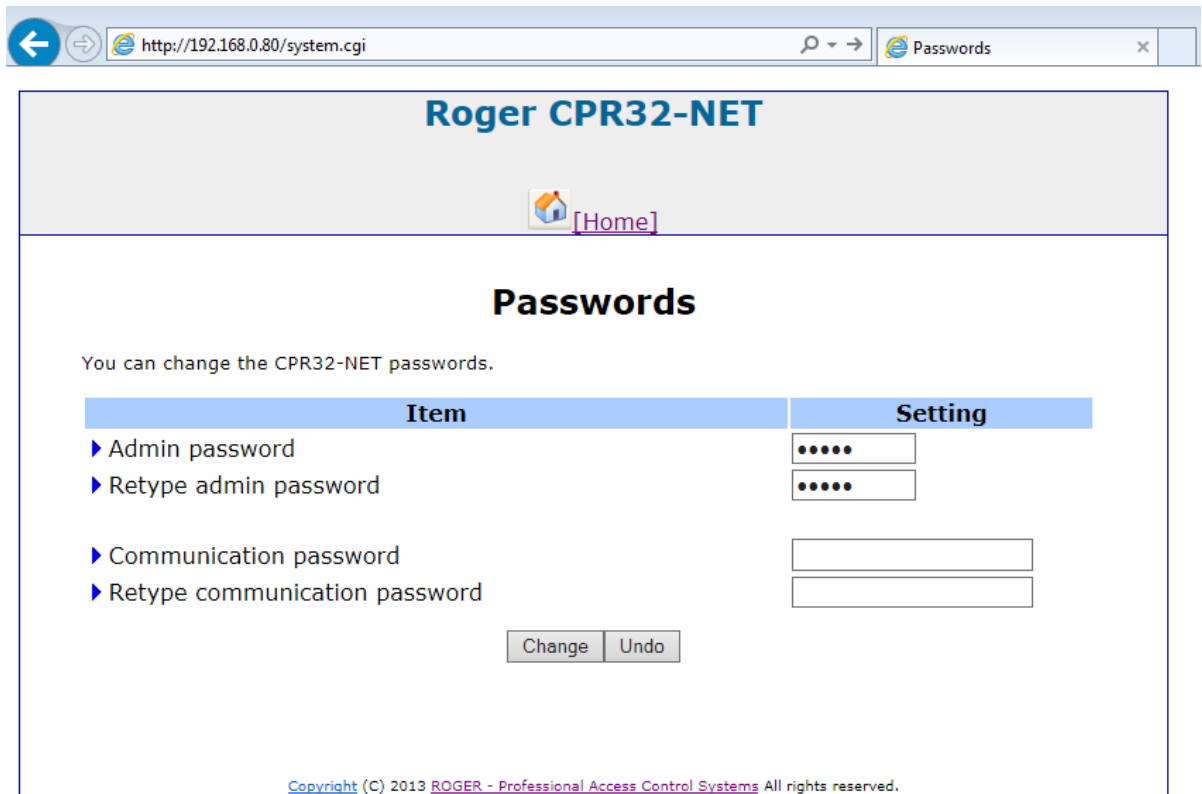

Fig. 11 Encrypted communication in CPR32-NET

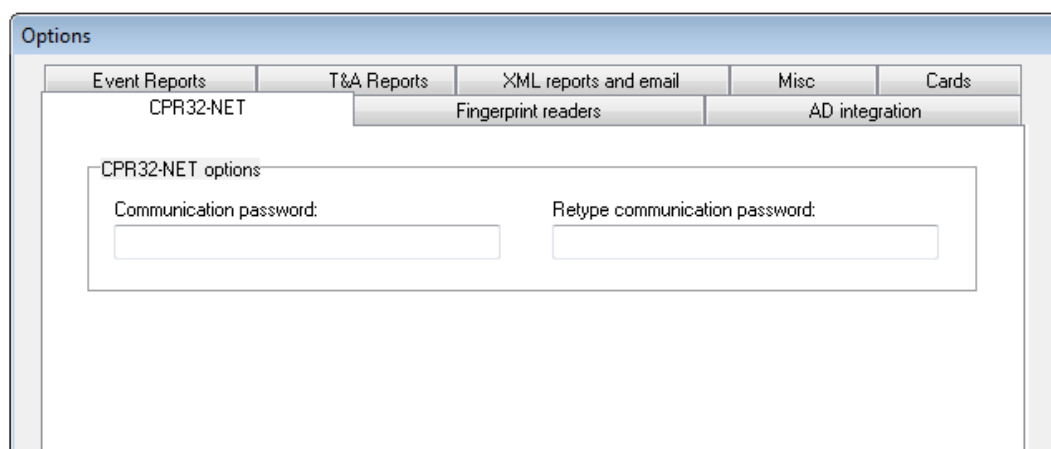

Fig. 12 Encrypted communication in PR Master

4.4.2 Communication with CPR32-NET from dedicated host

It is possible to limit communication with CPR32-NET to dedicated host with particular IP address in order to increase security of communication. This is can be configured by means of CPR32-NET webpage in the menu **Networks**, in the field **Dedicated host**, where IP address of such authorized computer can be entered.

4.5 Memory Reset

Memory Reset of CPR32-NET results in erasing of current settings and restoring of default settings.

Memory Reset procedure

- Switch off CPR32-NET power supply
- Remove connections to CLK and DTA terminals (if applicable)
- Connect CLK terminal with DTA terminal
- Switch on CPR32-NET power supply, all LEDs shall be on
- Wait until all LEDs start to flash
- Disconnect CLK and DTA terminals
- After a few seconds the CPR32-NET shall restart automatically and switch to normal mode with default settings. Default settings of CPR32-NET are specified in paragraph 4.1 Configuration with web browser

4.6 Firmware update

CPR32-NET firmware can be updated by means of CPR32-NET webpage or through RS485-1 port. In both cases, it is necessary to upload *.frg firmware file to the CPR32-NET. Firmware update by RS485-1 port is considered as emergency update which needs to be applied when CPR32-NET webpage cannot be accessed by any reason.

Note: After firmware update it might be necessary to perform Memory Reset according to section 4.5 Memory Reset.

Firmware update by web browser

Connect with CPR32-NET webpage, select the option **Firmware Upgrade**, select *.frg firmware file and then click the button **Send**. Restart CPR32-NET by means of **Reboot** button.

Firmware update by means of RS485-1 port

1. Connect CPR32-NET to computer with Roger CLD software by means of RS485 communication interface (e.g. UT-2USB or RUD-1). RS485-1 terminals of CPR32-NET must be connected respectively to RS485 terminals of communication interface.
2. Start Roger CLD software (see fig. 13).
3. Select serial port COMx with connected communication interface (UT-2USB or RUD-1).
4. Select *.frg firmware file by means of **Open FRG file** button.
5. Select the button **Send**.
6. Restart CPR32-NET by switching power supply off and on.
7. After CPR32-NET restart, Roger CLD shall automatically start uploading of firmware to CPR32-NET. Progress bar shall be shown in Roger CLD.

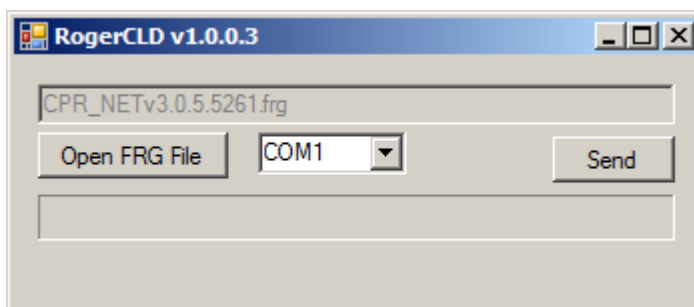

Fig. 13 Roger CLD software window

5. ORDERING INFORMATION

Table 6. Ordering information	
CPR32-NET-BRD	CPR32-NET network controller
ME-1	Metal enclosure for single unit
ME-2	Metal enclosure for multiple units
ME-5	Metal enclosure for multiple units
AX-9	Flash memory card
RUD-1	Portable USB-RS485 communication interface with 12VDC power supply output.

6. PRODUCT HISTORY

Table 7. Product history		
Product version	Released	Description
1.0	08/2013	The first commercial version of the product

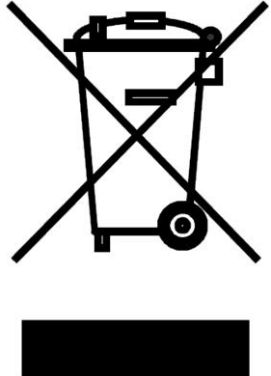
	<p>This symbol placed on a product or packaging indicates that the product should not be disposed of with other wastes as this may have a negative impact on the environment and health. The user is obliged to deliver equipment to the designated collection points of electric and electronic waste. For detailed information on recycling, contact your local authorities, waste disposal company or point of purchase. Separate collection and recycling of this type of waste contributes to the protection of the natural resources and is safe to health and the environment. Weight of the equipment is specified in the document.</p>
---	---

Contact:
Roger sp. z o.o. sp.k.
82-400 Sztum
Gościszewo 59
Tel.: +48 55 272 0132
Fax: +48 55 272 0133
Tech. support: +48 55 267 0126
E-mail: support@roger.pl
Web: www.roger.pl