

CODICE	PSP4/62T0Q
DESCRIZIONE	S-PARK 4/6 BARRIERA AUTOMATICA CON Q90BD

Elenco ricambi:

	Codice	MSPCAR02								
	Descrizione	BILANCIERE BARRIERA S-PARK ZINCATO								
	Prezzo	38,00 €								
	Lotto Minimo	1								
 <table border="1" data-bbox="383 1008 734 1097"> <thead> <tr> <th colspan="2">ELENCO RICAMBI</th> </tr> <tr> <th>NUMERO PARTE</th> <th>DESCRIZIONE</th> </tr> </thead> <tbody> <tr> <td>SMRSP90</td> <td>MOTORIDUTTORE S-PARK</td> </tr> <tr> <td>SMT20990</td> <td>MOTORE 24V CON ENCODER PER S-PARK4</td> </tr> </tbody> </table>	ELENCO RICAMBI		NUMERO PARTE	DESCRIZIONE	SMRSP90	MOTORIDUTTORE S-PARK	SMT20990	MOTORE 24V CON ENCODER PER S-PARK4	Codice	SMRSP490
	ELENCO RICAMBI									
	NUMERO PARTE	DESCRIZIONE								
	SMRSP90	MOTORIDUTTORE S-PARK								
SMT20990	MOTORE 24V CON ENCODER PER S-PARK4									
Descrizione	MOTORIDUTTORE S-PARK 4 24V									
Prezzo	400,00 €									
Lotto Minimo	1									
	Codice	SMRSP90								
	Descrizione	MOTORIDUTTORE S-PARK								
	Prezzo	230,00 €								
	Lotto Minimo	1								
	Codice	MSF06								
	Descrizione	SFERA D6 G10								
	Prezzo	0,20 €								
	Lotto Minimo	1								

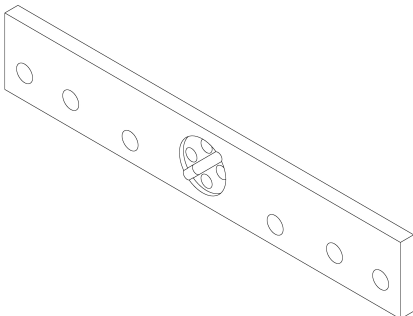
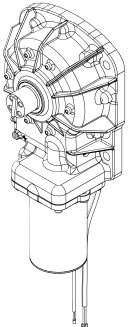
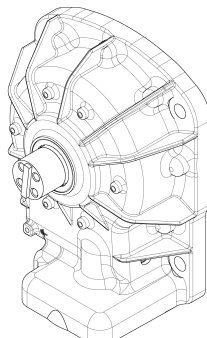
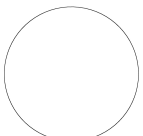
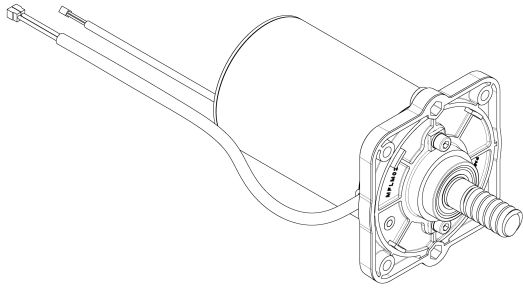

Codice	SMT20990
Descrizione	MOTORE 24V S-PARK 4 FINITO
Prezzo	240,00 €
Lotto Minimo	1

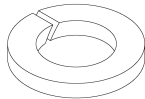

Codice	MRO05EZ
Descrizione	RONDELLA D5 ELAST. ZINC. UNI 1751
Prezzo	0,10 €
Lotto Minimo	1

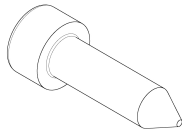

Codice	MVI6322CZ
Descrizione	VITE TCEI 6,3x22 AUTOFIL ZINC.
Prezzo	0,25 €
Lotto Minimo	1

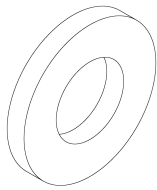

Codice	MRO06Z
Descrizione	RONDELLA D6 ZINC. UNI 6592
Prezzo	0,15 €
Lotto Minimo	1

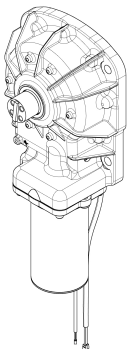

ELENCO RICAMBI	
NUMERO PARTE	DESCRIZIONE
SMT21090	MOTORE 24V S-PARK 6 FINITO
SMRSP90	MOTORIDUTTORE S-PARK

Codice	SMRSP690
Descrizione	MOTORIDUTTORE S-PARK 6 24V
Prezzo	420,00 €
Lotto Minimo	1

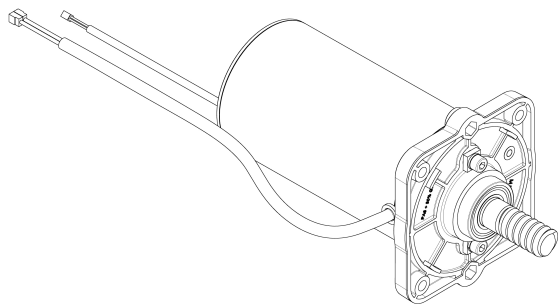

Codice	SMT21090
Descrizione	MOTORE 24V S-PARK 6 FINITO
Prezzo	250,00 €
Lotto Minimo	1

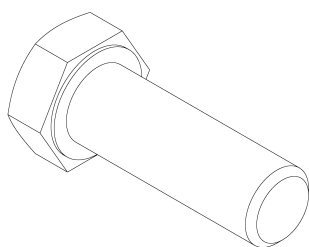

Codice	MVI1235AZ
Descrizione	VITE TE 12x35 ZINC. -UNI 5739-
Prezzo	0,80 €
Lotto Minimo	1

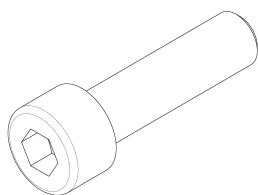

Codice	MVI0830CG
Descrizione	VITE TCEI 8.8 8x30 ZINC. UNI 5931 GEOMET
Prezzo	0,50 €
Lotto Minimo	1

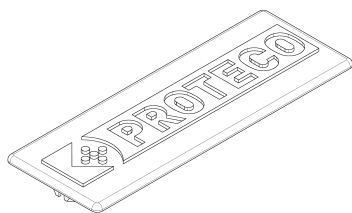

Codice	MPLSP08
Descrizione	MASCHERINA PER FORI FOTOCELLULA S-PARK
Prezzo	3,00 €
Lotto Minimo	1

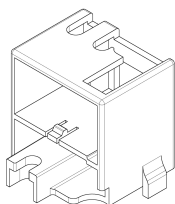

Codice	MPLSP12
Descrizione	SCATOLA PER MORSETTIERA 3P S-PARK E MATRIX
Prezzo	1,80 €
Lotto Minimo	1

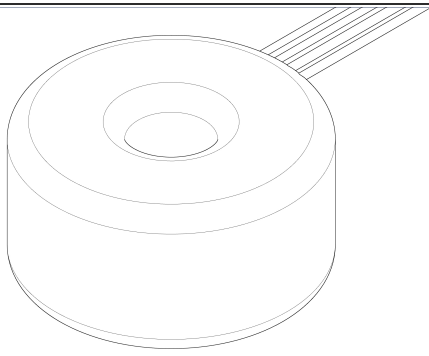

Codice	MTR17
Descrizione	TRASFORMATORE TOROID 230V/20V 130VA (Q20-Q90BD)
Prezzo	60,00 €
Lotto Minimo	1

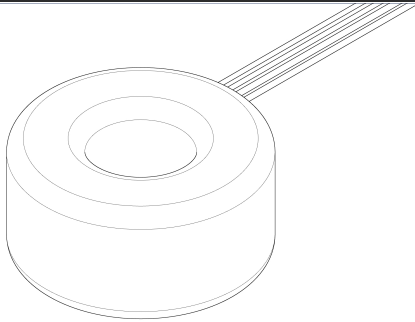

Codice	MTR21
Descrizione	TRASFORMATORE TOROID 230V/20V 200VA (Q90BD)
Prezzo	95,00 €
Lotto Minimo	1

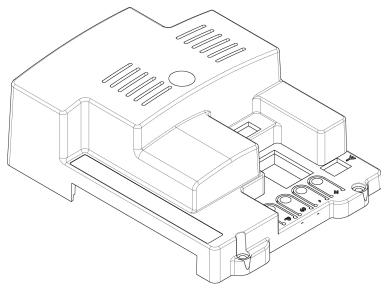

Codice	MPLSP04
Descrizione	COPERCHIO PER ARMADIO ELETTRONICA S-PARK /MATRIX
Prezzo	10,00 €
Lotto Minimo	1

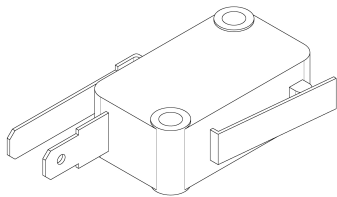

Codice	MMI12
Descrizione	MICRO 32500041 S-PARK N.A.
Prezzo	2,20 €
Lotto Minimo	1

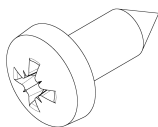

Codice	MVI3595D
Descrizione	VITE TC AUT. 3,5x9,5 -UNI 6954- ZINC.
Prezzo	0,10 €
Lotto Minimo	1

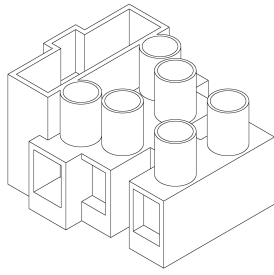

Codice	MMR09
Descrizione	MORSETTO CON PORTAFUSIBILI 3 POLI
Prezzo	0,30 €
Lotto Minimo	1

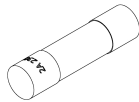

Codice	MFU2A
Descrizione	FUSIBILE 5x20F STD 2A 250V
Prezzo	0,60 €
Lotto Minimo	1

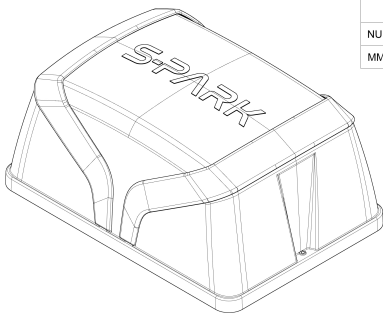

ELENCO RICAMBI	
NUMERO PARTE	DESCRIZIONE
MMR10	PRESA DI ALIMENTAZIONE DC 16V 1A

Codice	SCPSP0190
Descrizione	CUPOLA PER S-PARK FINITA
Prezzo	90,00 €
Lotto Minimo	1

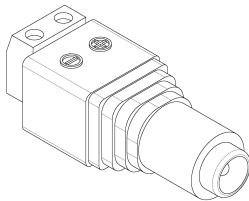

Codice	MMR10
Descrizione	PRESA DI ALIMENTAZIONE DC 16V 1A
Prezzo	0,00 €
Lotto Minimo	1

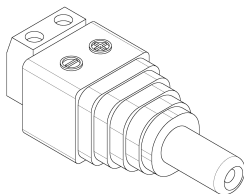

Codice	MMR11
Descrizione	CONNETTORE DI ALIMENTAZIONE DC 16V 2A
Prezzo	0,00 €
Lotto Minimo	1

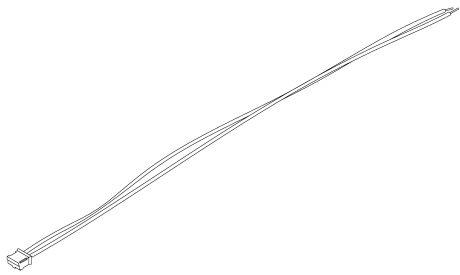

Codice	MCE15
Descrizione	CAVO LAMPEGGIANTE CUPOLA S-PARK
Prezzo	1,50 €
Lotto Minimo	1

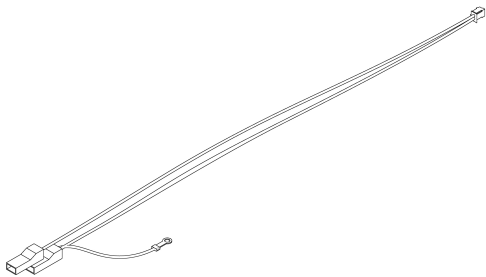

Codice	MCE16
Descrizione	CAVO SWITCH ARMADIO PER S-PARK
Prezzo	3,50 €
Lotto Minimo	1

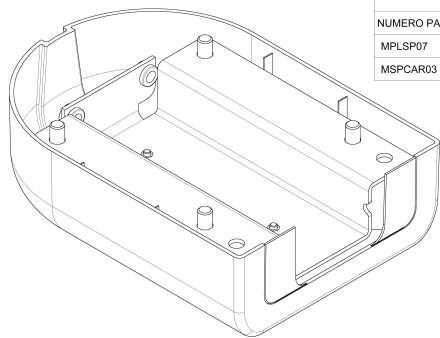

ELENCO RICAMBI	
NUMERO PARTE	DESCRIZIONE
MPLSP07	PARAMANO PER CONTROPIASTRA ASTA S-PARK
MSPCAR03	CONTROPIASTRA ZINCATA ASTA S-PARK

Codice	SSASP01
Descrizione	DOTAZIONE PER BARRIERA S-PARK
Prezzo	62,00 €
Lotto Minimo	1

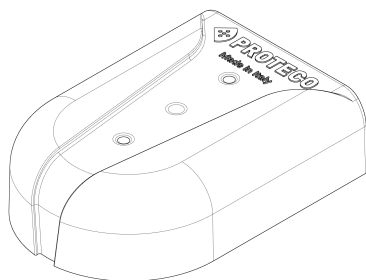

Codice	MPLSP07
Descrizione	PARAMANO PER CONTROPIASTRA ASTA S-PARK
Prezzo	14,50 €
Lotto Minimo	1

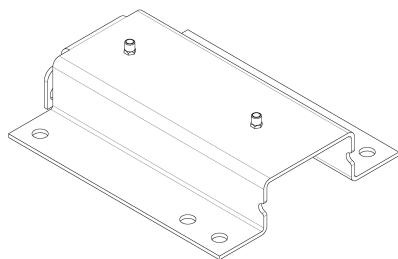

Codice	MSPCAR03
Descrizione	CONTROPIASTRA ZINCATA ASTA S-PARK
Prezzo	56,00 €
Lotto Minimo	1

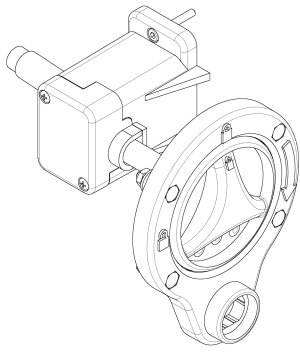

Codice	PLSSP0190
Descrizione	MANIGLIA DI SBLOCCO PER S-PARK
Prezzo	21,00 €
Lotto Minimo	1

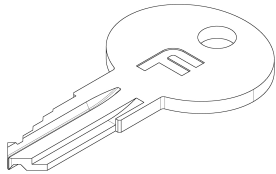

Codice	MCH21
Descrizione	CHIAVE PER SBLOCCO E SPORTELLO S-PARK
Prezzo	2,00 €
Lotto Minimo	1

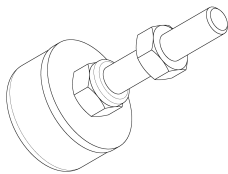

VALIDO FINO AL 10/2022

Codice	PAVSP0190
Descrizione	ANTIVIBRANTE REGOLAZ. FINECORSA S-PARK
Prezzo	0,00 €
Lotto Minimo	1

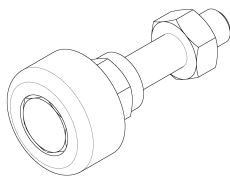

Codice	PAVSP0590
Descrizione	ANTIVIBRANTE REGOLAZ. FINECORSA S-PARK NEW
Prezzo	0,00 €
Lotto Minimo	1

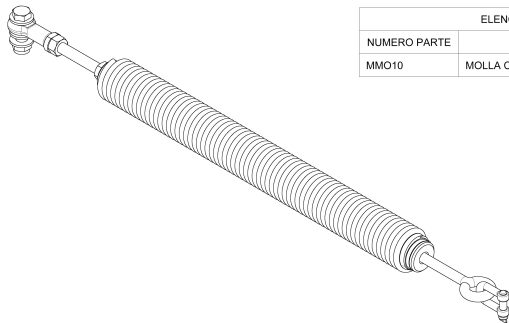

ELENCO RICAMBI	
NUMERO PARTE	DESCRIZIONE
MMO10	MOLLA CON TAPPI PER S-PARK 4m

Codice	SMO1090
Descrizione	GRUPPO MOLLA S-PARK 4
Prezzo	80,00 €
Lotto Minimo	1

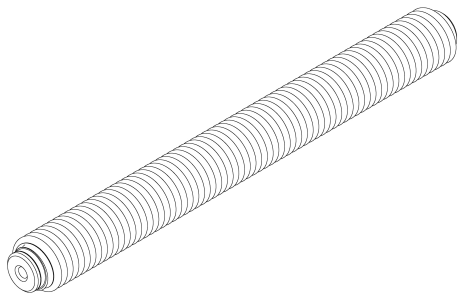

Codice	MMO10
Descrizione	MOLLA D50 L=480 mm CON TAPPI PER S-PARK 4 m
Prezzo	50,00 €
Lotto Minimo	1

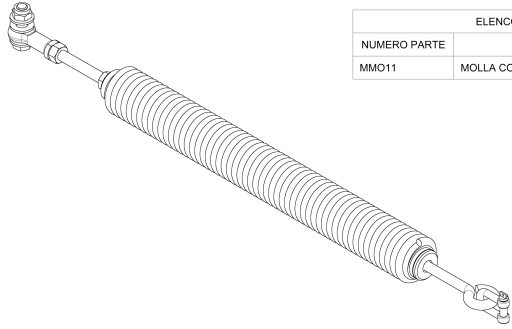

ELENCO RICAMBI	
NUMERO PARTE	DESCRIZIONE
MMO11	MOLLA CON TAPPI PER S-PARK 6m

Codice	SMO1190
Descrizione	GRUPPO MOLLA S-PARK 6
Prezzo	86,00 €
Lotto Minimo	1

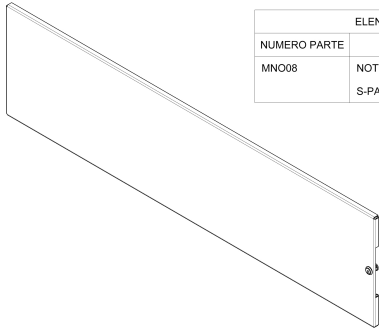

ELENCO RICAMBI	
NUMERO PARTE	DESCRIZIONE
MNO08	NOTTOLINO SBLOCCO PER S-PARK (CON 2 CHIAVI)

Codice	PSPCAR0590
Descrizione	SPORTELLO ARMADIO BARRIERA S-PARK CON NOTTOLINO
Prezzo	90,00 €
Lotto Minimo	1

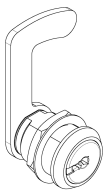

Codice	MNO08
Descrizione	NOTTOLINO SBLOCCO PER S-PARK (CON 2 CHIAVI)
Prezzo	9,50 €
Lotto Minimo	1

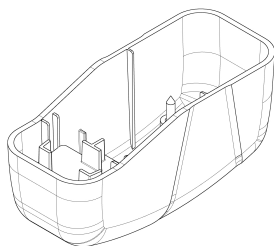

Codice	SSASP02
Descrizione	DOTAZIONE PER ASTA S-PARK
Prezzo	14,00 €
Lotto Minimo	1

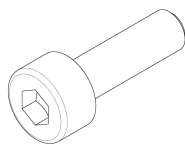

Codice	MVI0310CI
Descrizione	VITE TCEI 3x10 INOX UNI 5931
Prezzo	0,00 €
Lotto Minimo	0

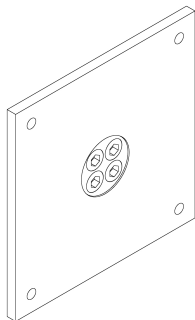

Codice	PSPCAR04
Descrizione	PIASTRA FISSAGGIO ASTA S-PARK ZINCATA CON VITI
Prezzo	52,00 €
Lotto Minimo	1

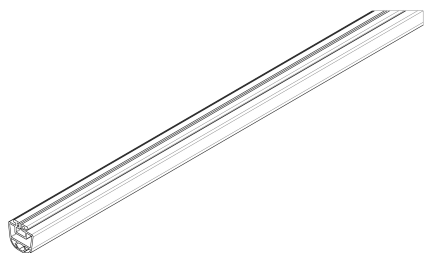

Codice	MSPAG6T0
Descrizione	PARACOLPI IN GOMMA L=6 m PER S-PARK
Prezzo	0,00 €
Lotto Minimo	0

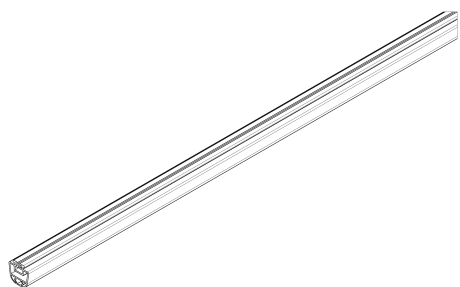

Codice	MSPAG4T0
Descrizione	PARACOLPI IN GOMMA L=4 m PER S-PARK
Prezzo	0,00 €
Lotto Minimo	0

PROTECO SRL - Via Neive 77, 12050 Castagnito (Cn) - Italy
Hai bisogno di aiuto? Chiamaci!
Dal lunedì al venerdì dalle 8.30 alle 12.00 e dalle 13.30 alle 17.00.
Tel. +39 0173 210132