

Q36S NEW

CONTRN UNIT FOR SLIDING GATES 230V

PROTECO S.r.l.
Via Neive 77 - 12050 Castagnito (CN) ITALY
Tel. +39 0173 210.111 - Fax +39 0173 210.199
www.proteco.net info@proteco.net

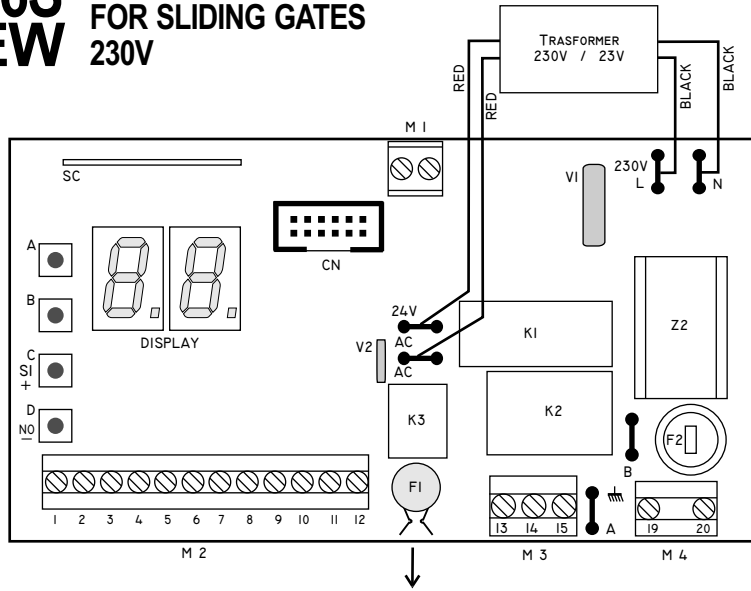

CONTROL UNIT COMPONENTS

- A TOP LEVEL MENU BUTTON
- B LOWER LEVEL MENU BUTTON
- C BUTTON TO INCREASE OR CHANGE TO YES (SI)
- D BUTTON TO DECREASE OR CHANGE TO NO
- F1 24V FUSE (RESTORABLE) 1,6A
- F2 230V FUSE 2A
- DISPLAY 7 SEGMENTS DISPLAY
- M1 RADIO/AERIAL TERMINAL BLOCK
- M2A/M2B CONTROLS AND SAFETY DEVICES TERMINAL BLOCKS
- M3 MOTOR TERMINAL BLOCK
- M4 MAIN POWER TERMINAL BLOCK
- A C EARTH CONNECTIONS
- B
- SC RADIO UNIT
- CN NOT USED CONNECTOR
- Z2 FILTER
- K1/ K2 MOTOR RELAY
- K3 BLINKER RELAY
- V1 PRIMARY VARISTOR
- V2 SECONDARY VARISTOR

RESTORABLE FUSE 24V
IMPORTANT: IF A TEMPORARY SHORT CIRCUIT OCCURS THE FUSE WILL RESTORE ITSELF AFTER FEW SECONDS.

IN CASE OF A PERMANENT SHORT CIRCUIT, CUT THE MAIN POWER OFF, REMOVE THE TERMINAL BLOCKS 2A AND 2B, WAIT FEW SECONDS AND THEN POWER THE UNIT AGAIN. THE FUSE WILL BE AUTOMATICALLY RESTORED. FIND AND REMOVE THE SHORT CIRCUIT CAUSE BEFORE PLUGGING THE TERMINAL BLOCKS IN.

PARAMETERS

B use **button B** to move to next parameter
C use **button C** to **INCREASE** a numeric value or change **NO** to **YES**
D use **button D** to **DECREASE** a numeric value or change **YES** to **NO**
 To save changes and to ensure that they are not lost when power is removed, use **button B** to step through **SU** parameter, the press and hold **button C** until the display reverts to idle display .

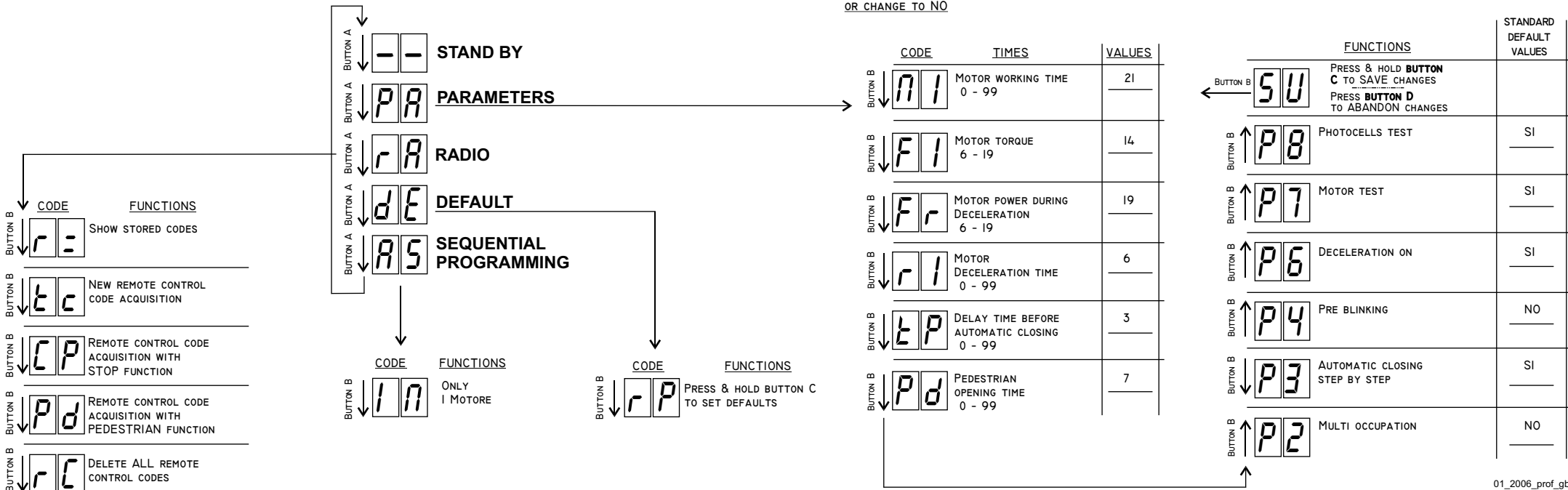
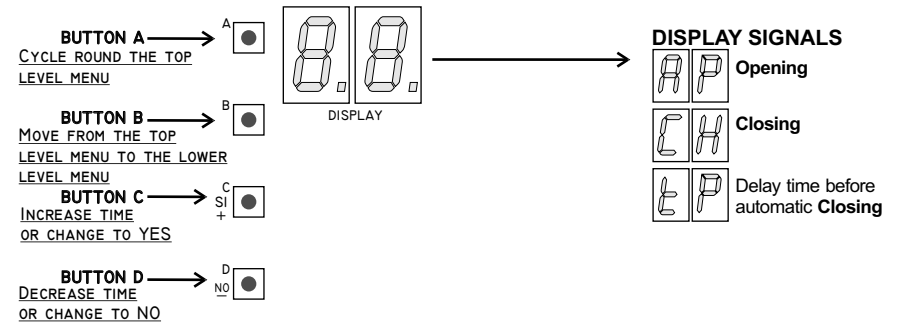



CODE	TIMES	VALUES
01	MOTOR WORKING TIME 0 - 99	21
F1	MOTOR TORQUE 6 - 19	14
Fr	MOTOR POWER DURING DECELERATION 6 - 19	19
r1	MOTOR DECELERATION TIME 0 - 99	6
tP	DELAY TIME BEFORE AUTOMATIC CLOSING 0 - 99	3
Pd	PEDESTRIAN OPENING TIME 0 - 99	7

FUNCTIONS	STANDARD DEFAULT VALUES
PRESS & HOLD BUTTON C TO SAVE CHANGES PRESS BUTTON D TO ABANDON CHANGES SU	
P8 PHOTOCELLS TEST	SI
P7 MOTOR TEST	SI
P6 DECELERATION ON	SI
P4 PRE BLINKING	NO
P3 AUTOMATIC CLOSING STEP BY STEP	SI
P2 MULTI OCCUPATION	NO

PROGRAMMING THE RADIO

IMPORTANT: BEFORE PROGRAMMING FOR THE FIRST TIME THE RADIO RECEIVER, DELETE ALL THE RECORDED TEST CODES. SEE FUNCTION  AT THE BOTTOM OF THIS CHAPTER



DISPLAYING STORED CODES

- Press the **button A** repeatedly until the display shows 
- Press **button B** until the display shows 
- The display will now cycle through each stored code from 01 to 50.



TO ERASE A SINGLE STORES CODE

- Press **button D** when the number of the code to be removed is displayed



STORING NEW REMOTE CONTROL CODE

- Press the **button A** repeatedly until the display shows 
- Press **button B** until the display shows 
- Press and hold the remote control button until a dot appears on the display (this means that the receiver is ready to store a new code) and simultaneously press **button C** to store the new code



STORING NEW REMOTE CONTROL CODE with STOP function

- Press the **button A** repeatedly until the display shows 
- Press **button B** until the display shows 
- Press and hold the remote control button until the dot appears on the display and simultaneously press **button C** to store the new code.

STORING NEW REMOTE CONTROL CODE with PEDESTRIAN function

- Press the **button A** repeatedly until the display shows 
- Press **button B** until the display shows 
- Press and hold the remote control button until the dot appears on the display and simultaneously press **button C** to store the new code





DELETING ALL STORED CODES

- Press the **button A** repeatedly until the display shows 
- Press **button B** until the display shows 
- Press and hold **button D** until the display shows 
- This indicates that all the codes have been erased

PROGRAMMING THE Q36S NEW PARAMETERS

SEQUENTIAL PROGRAMMING (method 2)

SLIDING GATE SEQUENTIAL PROGRAMMING

- Press **button A** (steps through the top menu) until the display shows 
- Press **button B** (steps through the sub-menu) until the display shows 
- Give a **START** signal: the leaf starts opening and the display shows 
- Wait until the leaf has done the 90% of the opening cycle and then give another **START** signal: the display shows  and the deceleration phase begins.
- When the opening phase has been completed (**OPENING LIMIT SWITCH**) and the display shows , the control board has stored the opening and deceleration times and starts calculating the "stay open" (pause) time
- At the reaching of the desired pause time, give another **START** impulse. The control board has stored the "stay open" time and the gate starts the closing cycle.
- When the closing cycle has completely finished, till the complete closure of the gate, the control unit automatically exits from the sequential programming process and all the working times have been saved.

Method 1 = **STANDARD**
Method 2 = **SEQUENTIAL**

Warning:

Before powering up and programming the control unit refer to the wiring scheme and then:

- Check that the motor connections are correct
- Check that the photocell connections are correct

Important:

If the photocells are not installed in closing phase, you must link terminals 3 and 9.
If the photocells are not installed in opening phase, you must link terminals 4 and 9.

- Check that the control connections are correct.

Important:

If an emergency stop button is not fitted, you must link terminals 2 and 8.

- Use the motor release key supplied to disengage the electric motor from the mechanical drive; then close the gate and re-engage.
- Power the control unit up



STANDARD PROGRAMMING PROCESS (Method 1)



- Give a **START** signal (terminal 1 and terminal 8). After an opening movement of about 240mm, the deceleration phase will start (since the control board is pre-adjusted for an opening of 2,50 m). The motor will wait about 3 seconds and after that will start again with the closing phase.
- Give a **START** signal to verify which functions and times are not suitable with the installation and take note.
- Enter the programming phase through the **buttons A** and **B** to reach the wished parameter
- Use the **buttons C** and **D** to change or confirm every single parameter
- IMPORTANT:** save the changes by selecting the parameter  and pushing the **button C**.



Example:



Increase the motor working time by 5 seconds



With the switched on control board, ensure that the display shows :  --

Press **button A** until the display shows  

Press **button B** until the display shows  

Wait until the display shows  

Press 5 times the **C** until the display shows  

Press **button B** until the display shows  

Press the button C for some seconds until the display shows  --

The motor working time has been increased from 21 to 26 seconds

SELF-DIAGNOSIS DISPLAY MESSAGES



PHOTOCELL'S TEST ERROR



FOTOCPELLULA O
COSTA DI SICUREZZA
IN APERTURA



CLOSING PHASE PHOTOCELL
BEAM INTERRUPTED
OR WIRING FAULT



BOTH OPENING AND CLOSING
PHASE PHOTOCELL BEAM
INTERRUPTED OR WIRING FAULT



STOP PRESSED
(OR OPEN CIRCUIT BETWEEN
TERMINAL 2 & 8)



LIMIT SWITCH
IN OPENING PHASE



LIMIT SWITCH
IN CLOSING PHASE



PEDESTRIAN START SIGNAL
(SHORT CIRCUIT BETWEEN
TERMINAL7 & 8)



START SIGNAL
(SHORT CIRCUIT BETWEEN
TERMINAL 1 & 8)



RADIO FOB
CONTINUOUSLY
TRANSMITTING



MOTOR PROBLEM (WIRING
FAULT, OBSTRUCTION OR
TORQUE SETTING TOO LOW)

SPECIAL FUNCTIONS



AUTOMATIC CLOSING FUNCTION

When set to **YES** ("SI"):

- an impulse during the opening phase will stop the motors until another impulse is received
- an impulse during the closing phase will stop and reverse the motors

When set to **NO**, the step-by-step operation is active:

- 1st impulse starts the **opening phase**
- 2nd impulse stops the **opening phase**
- 3rd impulse starts the **closing phase**



MULTI-USER FUNCTION

when set to **YES** ("SI"):

The control unit will not accept any command during the opening phase

TERMINAL BLOCK CONNECTIONS

All the connections must be done without power supply.

TERMINAL BLOCK 1

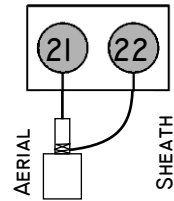

TERMINAL BLOCK 2

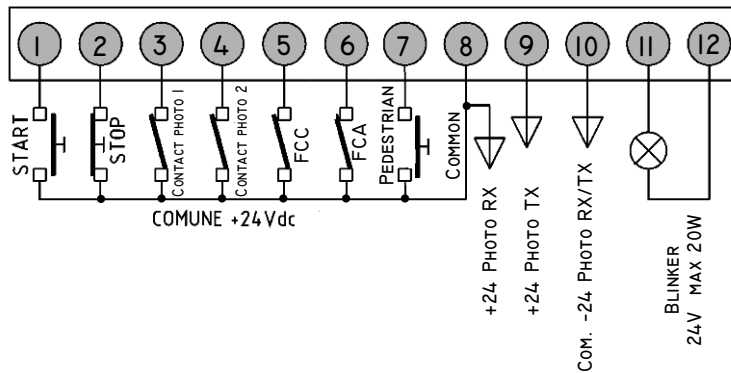

TERMINAL BLOCK 3

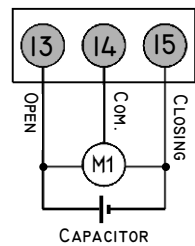

TERMINAL BLOCK 4

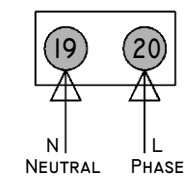

EARTH TERMINAL BLOCK CONNECTIONS

Connect the yellow/green motors cable to earth terminal **A**.
Connect the yellow/green network cable to earth terminal **B**.

TERMINAL BLOCK1 CONNECTIONS

21 Antenna or radio receiver signal
22 Sheath or negative for radio receiver

TERMINAL BLOCK 2 CONNECTIONS

1-8	Start control normally open (NA) for button, key selector, radio receiver or Timer clock connection. The Start control starts the programmed running cycle.
2-8	Stop control normally closed (NC). Emergency button. When pressed the gate stops immediately. In Opening phase and Break-time: at the first impulse the gate closes. In Closing phase: at the first impulse the gate opens. If, temporarily, the Stop contact is not used, link terminal 2 with terminal 8.
3-8	Input of one safety photocell in closing phase. Input of safety rubber edges and of safety photocell in closing phase. Input of several safety photocells in closing phase. The receiver contacts must be connected in series. Normally closed (NC). In opening phase: does not work In closing phase: Stop, break-time for 2 seconds, opening phase again. If, temporarily, the photocell contacts are not used, link terminal 3 with terminal 9.
3-9	Input only for safety rubber edges in closing phase. The contacts must be connected in series if there is more than one safety rubber edge. Normally closed (NC). In opening phase: does not work. In closing phase: Stop, break-time for 2 seconds, opening phase again.
4-8	Input for safety photocells in opening phase (for sliding gate). Normally closed (NC). In opening phase: Stops and changes direction for 3 seconds In closing phase: does not work If you also want to connect the safety rubber edges, you must connect in series their contacts with the photocell ones. If, temporarily, the photocell contacts are not used, link terminal 4 with terminal 9.
4-9	Input safety rubber edges in opening phase (for sliding gate). Normally closed (NC). In opening phase: Stops and changes direction for 3 seconds In closing phase: does not work Using more than one safety rubber edges, the contacts must be connected in series.
5-8	Limit switch input in closing phase.
6-8	Limit switch input in opening phase.
7-8	Pedestrian start input. Normally open (NA). Only one leaf start to open
8-10	Output for photocell receiver power supply. Output for extra 24V dc accessories power supply. With all Standard accessories included 100 mA are still available for extra accessories.
9-10	Output for photocell transmitter power supply.
11-12	Blinker intermittent output. 24V 20W max.

TERMINAL BLOCK 3 CONNECTIONS

13 **Motor M1- output** (13 Black; 14= Blue; 15= Brown)
14 The motor is preset to be fixed on the right side of the gate (looking from the interior side). If you fix the motor on the left side, you have to exchange the wire 13 with the 15 (motor) and the wire 5 with the 6 (limit switch) in the control board.
15 Capacitor between connector 13 and 15.

TERMINAL BLOCK 4 CONNECTIONS

19-20 Power input 230-240 Vac - 50/60 Hz. (19=Neutral - 20=phase)

WIRING SCHEME FOR THE Q36S NEW CONTROL UNIT

1 START

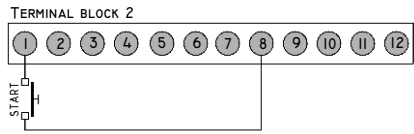

2 PEDESTRIAN START

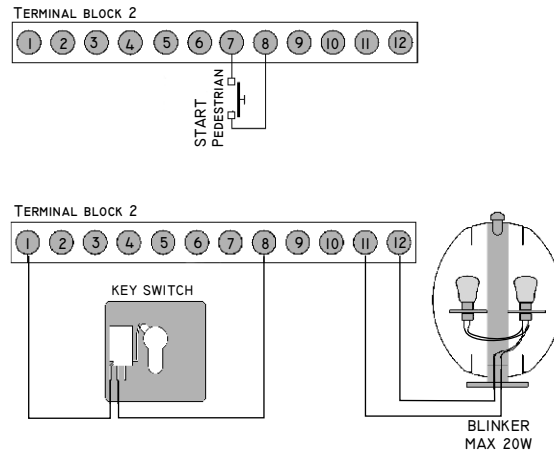

3 PERMANENT START COMMAND WITH TIMER

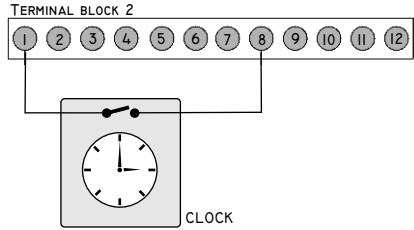

4 EMERGENCY STOP BUTTON

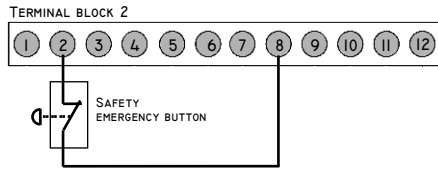

N.B.: Link terminals 2 and 8 if an emergency STOP button is NOT USED

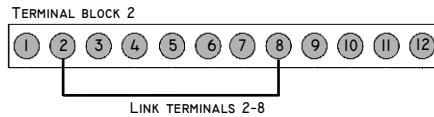

5 MOTOR AND LIMIT SWITCH

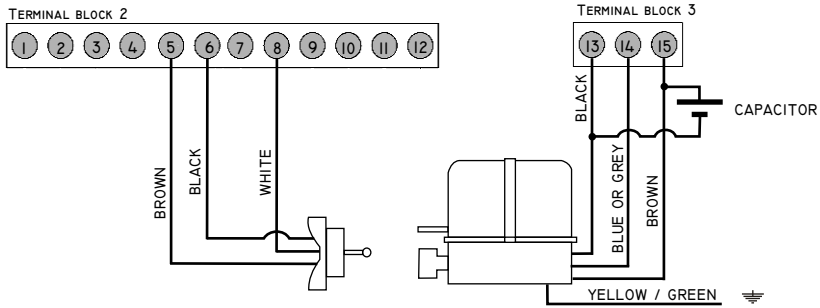

IF IT IS MOUNTED ON THE LEAF-HAND SIDE (looking the inside) TO INVERT WIRE 13 WITH WIRE 15 END WIRE 5 WITH WIRE 6

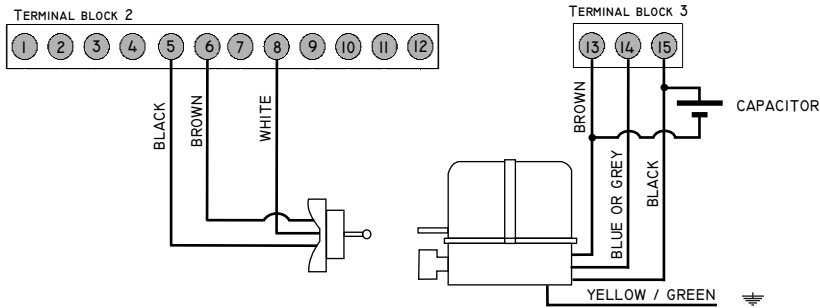

6 CONNECTING PHOTOCELL IN CLOSING PHASE

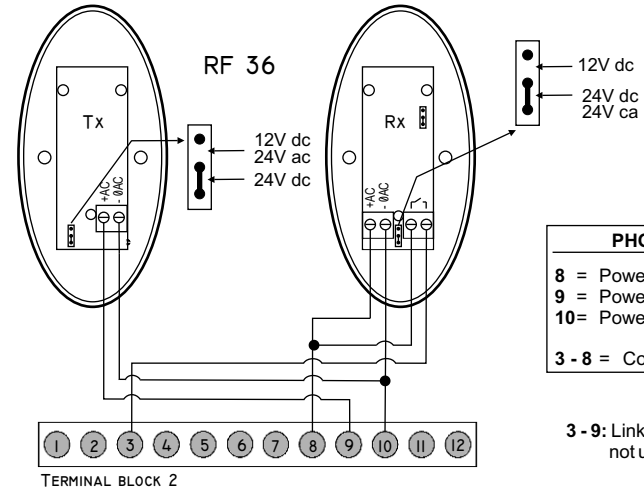

PHOTOCELLS CONNECTIONS

- 8 = Power supply + PHOTO RX
- 9 = Power supply + PHOTO TX
- 10 = Power supply - COM. PHOTO TX/RX
- 3 - 8 = Connections photocells

3 - 9: Link terminals 3 and 9 if the photocells are not used in the closing phase.

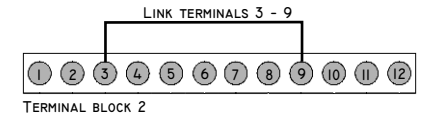

CONNECTING PHOTOCELL IN OPENING PHASE

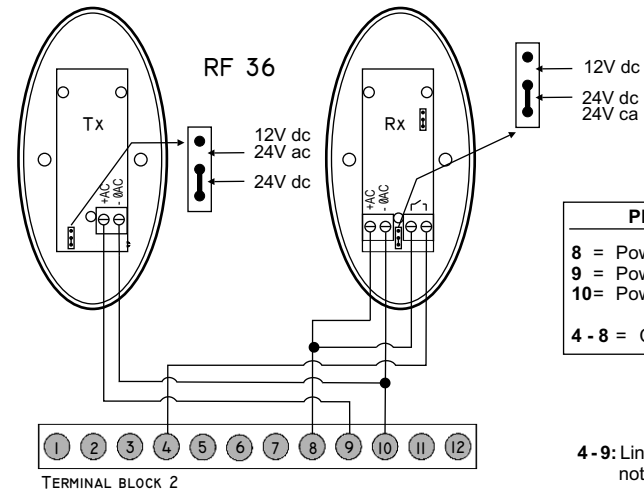

PHOTOCELLS CONNECTIONS

- 8 = Power supply + PHOTO RX
- 9 = Power supply + PHOTO TX
- 10 = Power supply - COM. PHOTO TX/RX
- 4 - 8 = Connections photocells

4 - 9: Link terminals 4 and 9 if the photocells are not used in the opening phase.

