

MATRIX

Q90SA Control Unit

Installation and User manual





INDEX

1. WARNING	4
2. FEATURES	4
2.1 Technical features	4
2.2 Control unit layout	4
3. Wirings	5
3.1 Main power 230V	5
3.2 Stand-alone Antenna (optional)	5
3.3 Wiring diagram	5
3.4 Terminals	6
3.4.1 START	6
3.4.1.1 START - wired contacts, key switch, key pad, timer	6
3.4.1.2 STOP – emergency push button or similar devices	6
3.4.1.3 PED (Pedestrian: partial opening)	6
3.4.2 RX and TX - Photocells	6
3.4.2.1 CL (RX) – Closing photocell (N.C. dry contact)	6
3.4.2.2 OP (RX) – Opening photocell (N.C. dry contact)	6
3.4.2.3 “-” e +24 (RX)	6
3.4.2.4 +24 e V- (TX block)	6
3.4.3 EDGE – Safety edges	6
3.4.3.1 CL (EDGE)	6
3.4.3.2 OP (EDGE)	6
3.4.4 LAMP -+24 and "-"- FLASHING LIGHT	6
3.4.5 AUX -+24 and "-PG" - PROGRAMMABLE OUTPUT	6
3.5 Start Up	7
4. OPERATION	7
4.1 Operational modes	7
4.1.1 Automatic closing after power cut	7
4.1.2 Programming keys	7
5. PROGRAMMING	8
5.1 Settings' configuration	8
5.2 Settings' list	9
5.3 Setting's description	10
5.3.1 A. RADIO	10
A.1 Store a remote control as START command	10
A.2 Store a remote control as PED command (pedestrian)	10
A.3 Store a remote control as AUX (2nd channel)	10
A.4 Delete a single remote control	10
A.5 Delete all remote controls	10
A.6 AUX/2nd channel output configuration	10
5.3.2 C. PROGRAMMING	10
C.1 Automatic programming	10
C.3 Reset (factory default)	11
C.4 Opening orientation/motor's position	11
C.5 Working logic configuration	11

5.3.3	F. Torque / Obstacle detection	11
	F.1 Obstacle detection	11
5.3.4	H. Special functions	11
	H.1 Pre-blinking	11
	H.2 Fixed-light blinker	11
	H.3 "Follow me" closing	11
	H.4 Automatic closing after power cut	11
	H.6 Master/slave configuration	
5.3.5	L. Working times	11
	L.1 Automatic closing	11
	L.2 Pedestrian automatic closing	11
	L.3 Pedestrian opening	11
5.3.6	P. Safety devices	12
	P.1 STOP	12
	P.2 CL (RX) - Closing photocell	12
	P.3 OP (RX) Opening photocell	12
	P.4 CL (EDGE) – Closing safety edge	12
	P.5 OP (EDGE) – Opening safety edge	12
5.3.7	U. Maintenance configuration (for installers only)	12
	U.1 Cycles counter	12
	U.2 Cycles performed since last maintenance service	12
	U.3 Maintenance countdown	12
	U.4 Maintenance recall signalling mode	12
	U.5 Installation date	12
	U.6 Trouble shooting and "dead man" functions	13
6. DISPLAY		13
6.1	Messages	13
6.2	Fault	13

1. WARNING

This manual for MATRIX brushless series contains important information concerning personal safety. An incorrect installation or an improper use may lead to severe injuries. Read carefully and pay particular attention to the safety sections marked by the yellow triangle .

 The installation of automatic doors, gates and barriers must comply with the Machinery Directive 2006/42/CE and EN 12453 regulation, and performed by qualified personnel.

 Make sure the main power line is equipped with state of the art safety grounding system; as well be sure the whole installation is protected by a power cut switch and against overcurrent.

Make sure the area is clear from flammable gases and/or electromagnetic interferences: it could lead to very dangerous injuries.

 Switch the power and batteries OFF before any operation.

After installation, packaging and waste materials (cardboard, plastic, metal parts etc.) must be kept away from children as they could be potentially harmful.

Use only original spare parts. Any alteration to the system is prohibited.

Proteco Srl will not respond in case of using additional and/or fake spares.

Proteco S.r.l. reserves the right to make changes to the product without notice.

2. FEATURES

2.1 Technical features

	Version 1800 kg	Version 2500 kg
Power supply	230V - 50Hz	
Max. absorption	5A	6A
Absorption in stand-by	2,1 W	
Motor's voltage	230V - 50 Hz	
Fuse	8A	
Capacitor	20 + 30	25 + 25
Accessories' voltage	24V dc (12 W photocells, 18 W blinker +AUX)	
Max. speed	11 m/min	11 m/min
Working cycle	50%	50%
Working temperature	da -30 °C a +55 °C	

START contacts	Start, Stop, Pedestrian.
Radio	Built-in 433 MHz radio receiver, storage up to 96 random or rolling codes.
Safety devices	Opening and closing photocell (self-test optional), powered at 24 Vdc 500 mA max., mechanical safety edge N.C. or resistive 8K2.
Outputs	Flashing light 24V DC 750 mA max. AUX 24V DC (programmable) 24 Vdc 750 mA max. Blinker + AUX = max. 750 mA totally.
Optional interfaces	Expansion connector for optional module cards Connector for home automation usb key / APP.
Optional functions	Operation mode, Obstacle detection, Follow me closing, Start up automatic closing, Pre-blinking, Cycles counter, Maintenance recall, Installation date.

2.2 Control unit layout

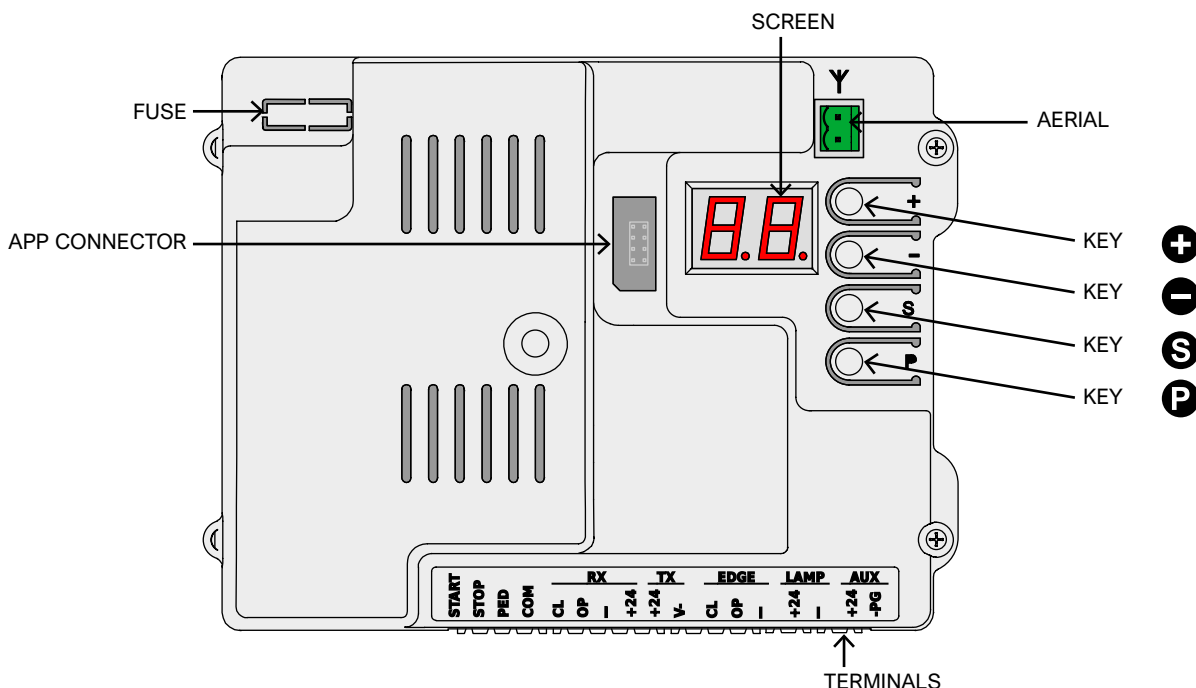

3. Wirings

3.1 Main power 230V

Locate the terminal block with fuse holder mounted close to gear block (picture on the left).
Wire live, earth and neutral as shown below:

Wire live, earth and neutral as shown below:

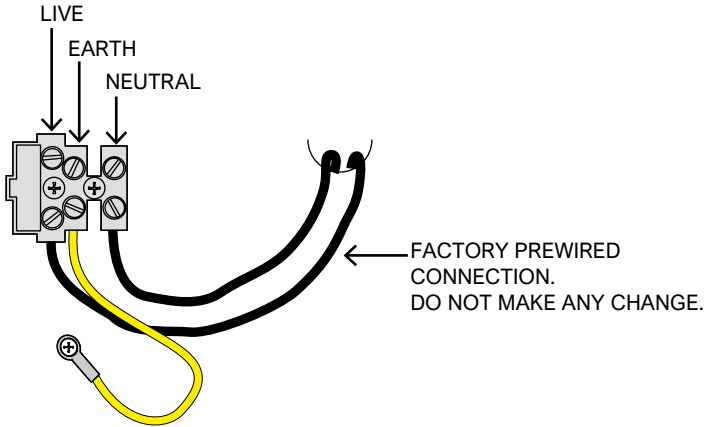

3.2 Stand-alone Antenna (optional)

The control unit is fitted with a Whip antenna. If you wish to connect an external stand-alone antenna, remove the Whip aerial and wire the core cable (RG58); wire the shield cable on the other terminal as shown in the picture.

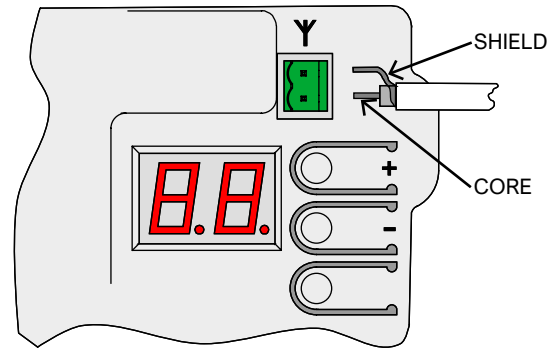

It is fundamental to wire the system to the earth.

3.3 Wiring diagram

(The connections shown are all optional)

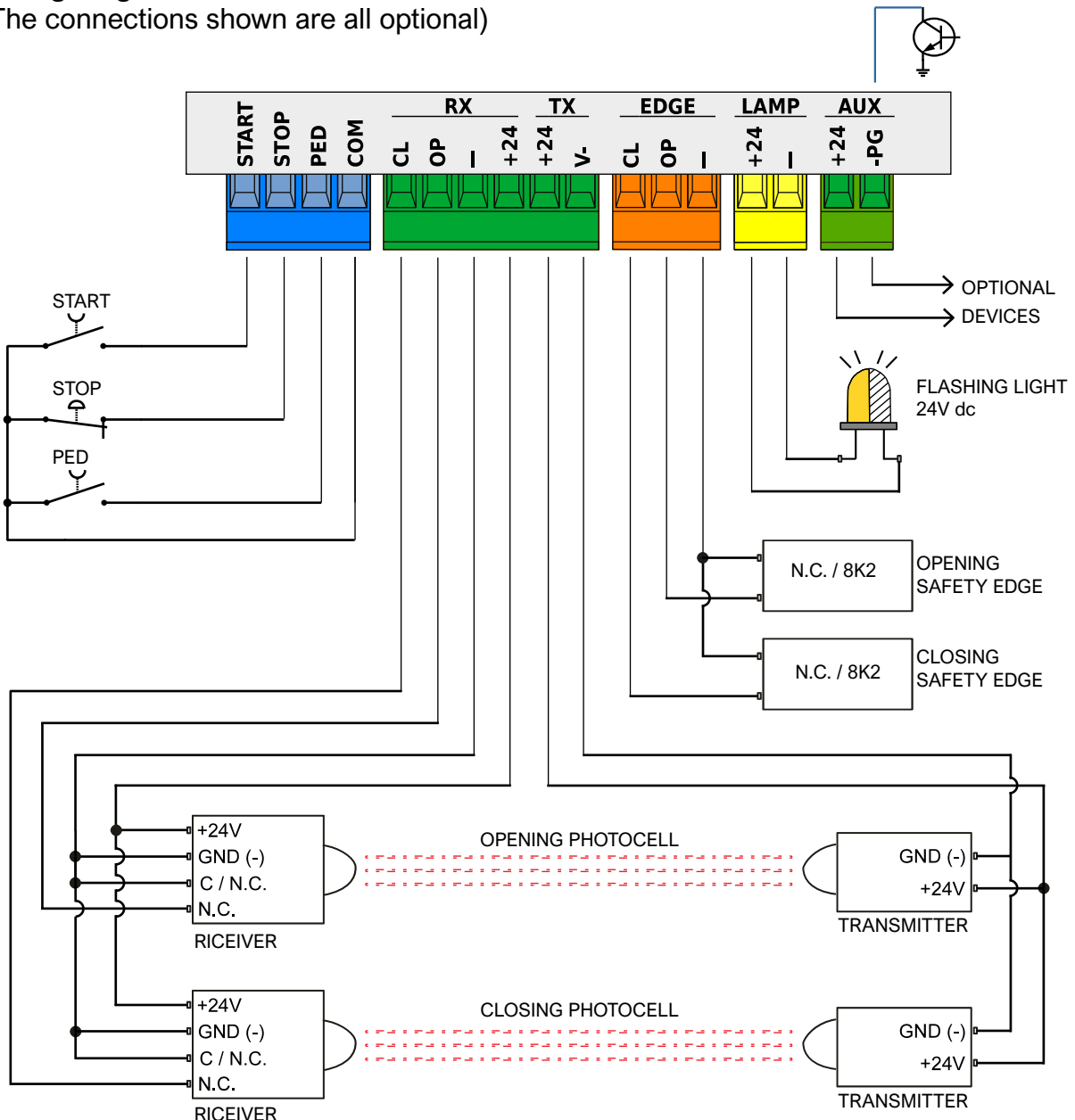

3.4 Terminals

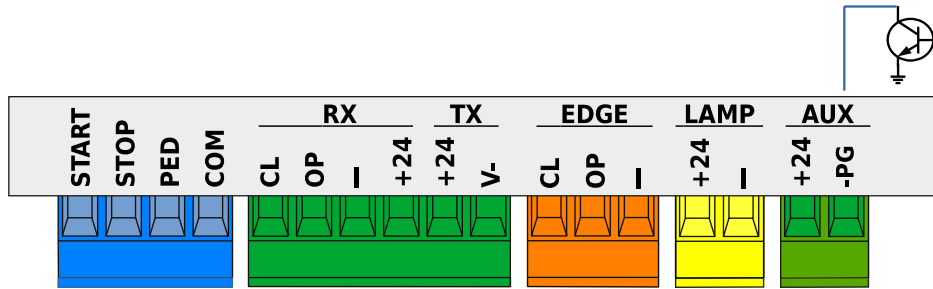

3.4.1 START

3.4.1.1 START - wired contacts, key switch, key pad, timer

Any start contact shall be wired to this terminal, refer to [Chapter C.5](#), page 11.

Any pulse below 10 seconds is considered as a regular **START** command, and once duty cycle is completed, it starts the automatic closing countdown ([Chapter L.1](#), page 11); any pulse over 10 seconds activates the timer mode and the gate will remain in opening position according to the timer set up.

Wire **N.O.** contacts between **START** (or **PED**) and **COM**. Any additional contact shall be wired in parallel.

3.4.1.2 STOP – emergency push button or similar devices

Any stop contact shall be wired to this terminal. Multiple stop contacts shall be wired in series between **STOP** and **COM**. If no **STOP** contact is wired, deactivate **P.1** at page 12, otherwise no operation will start. Any **STOP** command immediately stops any operation.

3.4.1.3 PED (Pedestrian: partial opening)

The operation logic is the same of **START**: adjust **L.3** to set the desired opening width and set **L.2** to activate the pedestrian automatic closing, page 11.

3.4.2 RX and TX - Photocells

3.4.2.1 CL (RX) – Closing photocell (N.C. dry contact)

Any closing photocell and similar devices shall be wired to this terminal, N.C. contacts. Wire the receiver's N.C. contact between CL and "-". Additional photocells shall be wired in series. Power the receiver from +24 and "-", while power the transmitter from +24 and "V-" (TX terminal). Refer to [Chapter 3.3](#) page 5, to get the complete wiring view.

3.4.2.2 OP (RX) – Opening photocell (N.C. dry contact)

Any opening photocell and similar devices shall be wired to this terminal, N.C. contacts. Wire the receiver's N.C. contact between OP and "-". Additional photocells shall be wired in series. Power the receiver from +24 and "-", while power the transmitter from +24 and "V-" (TX terminal). Refer to [Chapter 3.3](#) page 5, to get the complete wiring view.

3.4.2.3 "-" and +24 (RX)

These terminals permanently power photocell's receivers. **Attention: voltage for receivers and transmitters is limited to a single fuse of 500 mA.**

3.4.2.4 +24 and V- (TX block)

These terminals power photocell's transmitters. Unlike terminals "-" and +24 of RX block, TX terminal cuts power during photocell test. **Attention: voltage for receivers and transmitters is limited to a single fuse of 500 mA.**

3.4.3 EDGE – Safety edges

Safety edges shall be wired to this terminal, N.C. or resistive 8K2 contacts; set **P.4** and **P.5** according to the kind of contact used. Additional contacts shall be wired in series, as explained in the below example (closing safety edge):

- If you have 2 N.C. contacts set **P4 to 1**.
- If you have 1 N.C. ccontact and 1 8K2 set **P4 to 2**.
- If you have just 1 8K2 resistive contact set **P4 to 2**.

Every series can only take 1 8K2 resistive contact. If you have 1 NC contact and 1 8K2 resistive contact, this last one will command.

3.4.3.1 CL (EDGE)

Wire the closing safety edge between CL and "-".

3.4.3.2 OP (EDGE)

Wire the opening safety edge between OP e "-".

3.4.4 LAMP +24 and "-" - FLASHING LIGHT

Wire the flashing light to these terminals, that deliver intermitting 24V DC during operation. It is possible to switch the intermittance to permanent voltage, just during operation, setting up **H.2**. **Attention: LAMP + AUX outputs together are limited to max. 750 mA.**

3.4.5 AUX +24 and "-PG" PROGRAMMABLE OUTPUT

AUX terminal is 24V DC powered and can be configured performing several functions, see [Chapter A.6](#) page 10. Terminal +24 is always powered at 24 volt; terminal -PG is normally an open circuit, that automatically floats to GND (earth) when the output is activated. This output allows to command garden lights, warning lights, and relays (24Vdc). **Attention: LAMP + AUX outputs together are limited to max. 750 mA.**

3.5 Start Up

Once mechanical and electrical installation is completed proceed to the following steps, respecting the chronological order:

- Proceed to **programming, starting C.1** page 10.
In this way travel and proper values will be saved to command the gearmotor.
If speed changes, the whole programming procedure shall be repeated.
- Adjust any parameters if needed.
- Store remote controls: **A.1** if you wish to store **START** and **A.2** if you wish to store **PED** (pedestrian), page 10.
- Proceed to general test - **safety devices in particular.**

For more details on operation refer to **chapter 4.1** page 7, while refer to **chapter 5** page 8 to get an overview on parameters and functions.

4. OPERATION

4.1 Operational modes

During normal operation the gate may be in one of the following modes:

- **STILL**, in stand-by for operation.
Only when in STILL mode it is possible to enter parameters.
Flashing light is switched off, but it may blink if faults occur.
Screen shows a couple of horizontal lines blinking.
- **OPENING**; flashing light blinks slowly, and the screen displays vertical lines opening.
If during opening an obstacle is detected, the gate reverts, remains in stand-by during 10 seconds and starts to open again (screen shows countdown).
- **AUTOMATIC CLOSING COUNTDOWN**; flashing light blinks shortly; when time left is below 12 seconds the flashing light remains switched on and fixed.
Screen shows countdown.
If working logic is STANDARD (see **C.5**, page 11) a START command will STOP the gate.
- **CLOSING**; if during closing an obstacle is detected, position.
Flashing light blinks regularly and quickly.

4.1.1 Automatic closing after power cut

Once the power supply is restored, the control unit counts 15 seconds and then the gate starts closing, if all the following conditions have been fulfilled:

- **H.4**, page 11 is activated.
- **C.4**, page 11 is not set to position 2 (factory setting).
- No wired/radio command is sent, no key is pressed.

During the 15 seconds the system double checks that all the a.m. conditions have been respected.
If this is the case, the blinker will flash shortly to confirm closing will start soon.

4.1.2 Programming keys

Pressing any key during operation the gate stops.
With an exception for **+** key: if pressed during countdown (see **chapter 4.1**) it makes the gate start working again.

When in still mode, the screen displays two symbols (weak flashing) or just one if energy save mode is on.
In this case it is possible to use some of the keys or a combination of them, to start some functions.

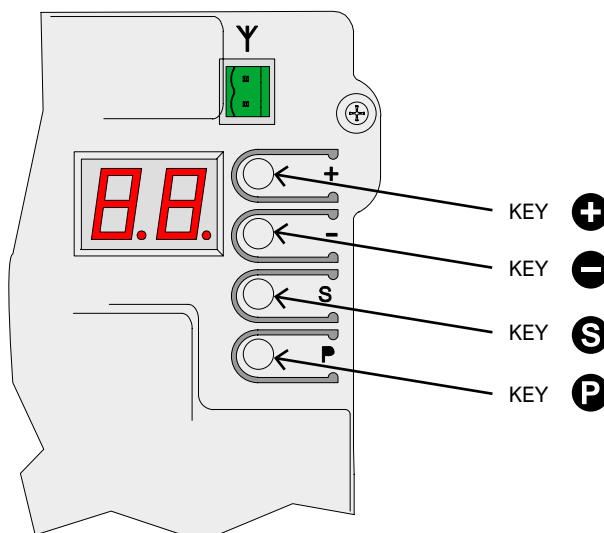

KEYS (User mode)	FUNCTION
+	START command
-	PEDESTRIAN command
Press S hold and press +	OPENING command
Press S hold and press -	CLOSING command
P (press and hold for short seconds)	Programming menu: the display shows A.1

When in programming mode the display alternatively shows the outstanding setting and its value.

Ex.: setting H.2 / value 1, the display reads first "H.2" and after "01.". In this circumstance it is possible to handle the following programming keys and functions:

KEYS (Programming mode)	FUNCTION
+	This key increases the value of the setting. Keep pressed to speed.
-	This key decreases the value of the setting till 0. Keep pressed to get to zero.
P	This key switches from menu to menu (ex. H.3 - J.1). From U.x menu the control unit returns back to A.1.
S	This key switches from setting to setting (ex. H.3 - H.4). From last setting control unit returns back to the first one (ex. H.6 - H.1).
P + S (press P hold and press S)	This key quits the programming and returns to USER mode.

5. PROGRAMMING

5.1 Settings' configuration

Proceed to programming only when the gearmotor is in still mode (any key pressed during operation stops the operation). Press key P and hold shortly (a quick pulse is insufficient): display reads "A.1".

Press P as many times as to find the desired setting. Then press S as many times as to find the figure corresponding to the desired parameter (right side of the display). EX.: If you wish to go to H.2 and you are in A.1 position, press 3 times key P (scrolling through C.1, F.1 and H.1), then press key S one time (to move from H.1 to H.2).

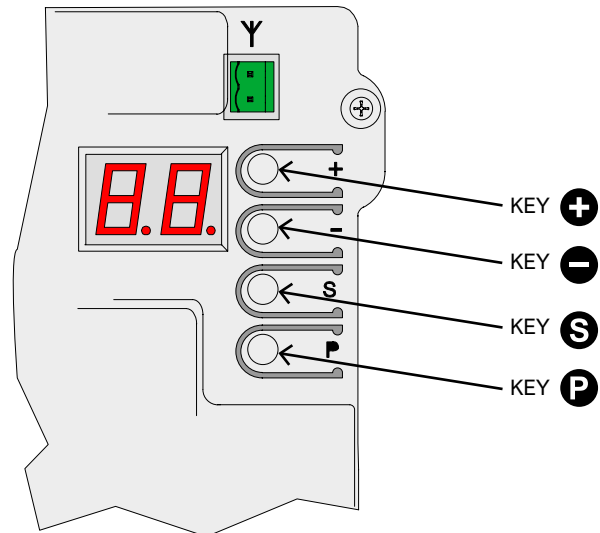

If you wish to reduce or increase the value of the setting use + - . **A ttention!** when you reach the desired setting, wait shortly while the screen displays the current value and setting alternatively. If you wish to move to a different setting, press P and then S as previously outlined.

To quit the programming press P and S together. Or you can wait two minutes and the control unit quits the programming automatically.

Some settings are mere functions and therefore have no value. They may need longer or shorter pression of key + to be activated. Usually the display shows a line "-" close to key + to confirm function is activated. Unlike other settings as A.1, A.2 and A.3 that do only need confirmation after receiving a radio signal.

5.2 Settings' list

Here below you will find a resume of all available settings and functions.
More details are found in **Chapter 5.3**, page 10.

	ID	DESCRIPTION	LINK
A	A.1	Store a remote control as "START" command	C.5
	A.2	Store a remote control as PED pedestrian command	C.5
	A.3	Store a remote control as AUX / 2nd channel	A.6
	A.4	Delete a single remote control	
	A.5	Delete all remote controls	
	A.6	AUX / 2nd channel output configuration	A.3 U.4
C	C.1	Automatic programming	C.4
	C.3	Reset (factory default)	
	C.4	Opening orientation/motor's position	C.1
	C.5	Working logic configuration	
F	F.1	Obstacle detection	
H	H.1	Pre-blinking	
	H.2	Fixed-light blinker	
	H.3	"Follow me" closing	
	H.4	Automatic closing after power cut	
	H.6	Master / Slave - TWINNING configuration	
L	L.1	Automatic closing (START)	
	L.2	Pedestrian automatic closing (PED)	
	L.3	Pedestrian opening	
P	P.1	STOP	
	P.2	CL (RX) – closing photocell	
	P.3	OP (RX) – opening photocell	
	P.4	CL (EDGE) – closing safety edge	
	P.5	OP (EDGE) – opening safety edge	
U	U.1	Cycles counter	
	U.2	Maintenance countdown	U.4
	U.3	Maintenance recall	U.4
	U.4	Maintenance recall signalling mode	U.3
	U.5	Installation date	
	U.6	Trouble shooting and "dead man" functions	

5.3 Setting's description

5.3.1 A. RADIO

This menu includes procedures about how to store radio devices, remote controls mainly.

The control unit responds just to radio codes "**already stored**"; every remote control is matched to a progressive number that is displayed on the screen at every start command pulse. In this way if by accident a remote control is lost it can be easily deleted from the control unit memory. It is possible to store up to 96 different users; when a remote control is deleted its radio position still remains available for a new remote control storage.

Any key of the remote control can be set up as follows:

- **START** command, corresponding to a wired contact to **START** terminal.
- **PEDESTRIAN** command, corresponding to a wired contact to **PED** terminal
- **AUX**, known as well as 2nd radio channel, matched to **AUX** output.

Choose the function you need before starting storing any key of the remote control.

There are three different settings available (**A.1**, **A.2** and **A.3**) corresponding to different functions.

A.1 Store a remote control as START command

Set **A.1**. Press the remote control (the display reads "Y-") and while holding, press key \oplus to store and confirm.

If successful the display will show the radio position matched to the remote control.

In case of an already existing remote control, the display will only show its radio position (01, 02, ...).

If storage capacity is full the display will read "FF".

It is important to press key \oplus when the remote control is transmitting, otherwise the radio code storage will not be successful and the control unit might save any incoming undesired radio signal. If you have additional remote controls to store, repeat the same procedure.

Make sure the screen displays "Y-" or a number, then press \oplus .

A.2 Store a remote control as PED command (pedestrian)

Set **A.2** and repeat the above procedure.

For more details refer to [Chapter 3.4.1.3 PED](#), page 6.

A.3 Store a remote control as AUX (2nd channel)

Set **A.6** according to the AUX function you need or in alternative plug the optional interface card MRX01 duly set up.

Then proceed to set **A.3** carrying out the same procedure applied for **A.1** and **A.2** configuration.

A.4 Delete a single remote control

Every remote control stored is matched to a radio position identified by a number.

Set **A.4**, press \oplus or \ominus to find the remote control you need to delete, then press both keys together and hold until the display flashes "YY".

If there is just a remote control stored, the display will show just that one.

A.5 Delete all remote controls

Set "A5", or when the screen displays "-." press \oplus to confirm you wish to delete all remote controls stored and hold during 5 seconds; if all remote controls have been successfully deleted, the display flashes "YY".

A.6 AUX/2nd channel output configuration

The **AUX** is a multifunction output: it can be used as maintenance recall, refer to [Chapter U.4](#) page 12.

Or in alternative it can set up the following modes/functions:

A.6	AUX - Functions/Modes
0	AUX output is OFF. AUX output is ON if U.4 maintenance recall is activated.
1 (factory set up)	2nd channel / MONOSTABLE: the output is activated by a remote control stored in A.3 AUX. The contact closes when giving and holding a start pulse with the remote control. The contact opens just when the remote control's key is released.
2	2nd channel /BISTABLE: the output is activated by a remote control stored in A.3 AUX. The contact closes or opens when giving a start pulse with the remote control.
3	SIGNALLING GATE IS FULLY OPENED: the output is activated when the gate is fully opened. The optional interface card MRX01 can perform the same function but in a slightly different way.
4	SIGNALLING GATE IS FULLY CLOSED: the output is activated when the gate is fully closed.
5	COURTESY LIGHT (30"): the output is activated when the contact closes and remains closed during the whole working cycle. The contact opens after 30 seconds after working cycle is completed.
6	COURTESY LIGHT (60"): the output is activated when the contact closes and remains closed during the whole working cycle. The contact opens after 60 seconds after working cycle is completed.
7	COURTESY LIGHT (90"): the output is activated when the contact closes and remains closed during the whole working cycle. The contact opens after 90 seconds after working cycle is completed.

5.3.2 C. PROGRAMMING

C.1 Automatic programming

This procedure allows to learn the mechanical features of the gate: working cycle, speed, torque and accelerations; programming may be carried out just when installation is completed.

Matrix gearmotor is built in such a way that, when properly installed, its mechanical characteristics do not change over time, so programming can normally be performed only once.

The procedure carries out two opening and two closing operations; before start programming make sure that everything is in order: if one of the operations is interrupted (due to the pressure of a button or the intervention of a safety device) the procedure must be repeated from the beginning.

Set **C.1** and press \oplus holding during 5 seconds.

If **C.4** is not configured yet (as in case of a brand new control unit), the screen will display the opening direction of the gate.

Press \oplus to set RH opening and \ominus to set LH opening.

If **C.4** is configured the display remains clear.

The gate performs 4 steps; every step is shown on the display (01, 02, 03...) with a short pause in between.

In any moment it is possible to stop the operation, just pressing any key.

Step (01), gate slowly starts opening until detecting the mechanical limit switch. If the gate works to the opposite direction, stop the operation and properly set up **C.4**. Then repeat **C.1**.

Step (02), gate slowly starts closing until detecting the closing position; the following steps are meant to double check all settings are correct.

The automatic learning is successfully completed when display shows "YY" flashing.

C.3 Reset (factory default)

Set **C.3**, press **+** and hold during 5 seconds to confirm reset (return to factory settings).

This setting allows to delete any configuration previously set, but parameters **U.5**, **U.1** and **U.2 CANNOT** be reset and no remote control previously stored can be deleted.

Now repeat **C.1** procedure.

Reset is successfully completed when display shows “**YY**” flashing.

C.4 Opening orientation/motor's position

This parameter shows the gate's opening direction or the motor's position.

Looking from inside the property values are intended as follows:

C.4	Boom configuration
0	Motor is positioned to the right, opening to the left.
1	Motor is positioned to the left, opening to the right.
2 (factory set up)	No configuration is set, motor is intended to the right.

C.5 Working logic configuration

It is possible to set 3 different working logics, no matters if wired or remote commands:

C.5	Working logic
0 (factory set up)	SEQUENTIAL (STEP BY STEP) Every START command stops or reverts the working cycle according to the sequence: OPEN - STOP - CLOSE - OPEN ...
1	PRIORITY TO OPENING Every START command gives priority to opening; gate automatically closes according to the time set (refer to L.1 Automatic closing, page 10)
2	SEMI AUTOMATIC (OPEN-CLOSE separate) START terminal commands the opening; START2 terminal commands the closing. Automatic closing activates if configured, refer to L.1 Automatic closing and L.2 Automatic closing pedestrian opening.

5.3.3 F. Obstacle detection

F.1 Obstacle detection

Obstacle detection is a safety feature that complies with outstanding regulations and makes the gate area more protected and safer.

If during operation any speed alteration or sudden stress are detected, the gate stops in order to avoid or limit damages to persons or objects.

This feature can be adjusted on different sensitivity levels:

0 = detection is OFF while 10 = maximum detection sensitivity; factory value (default) is set to 5.

5.3.4 H. Special functions

H.1 Pre-blinking

Pre-blinking feature warns the user that closing will start soon.

Receiving a start command the blinker starts flashing during a few seconds before gate starts closing.

Pre-blinking time is adjustable, from 0 (factory value) to 8 seconds.

H.2 Fixed-light blinker

If you wish to switch the blinker to fixed-light mode, set **H.2** to **1**.

Factory value is 0.

H.3 "Follow me" closing

This function allows the gate to immediately close after cutting the photocell beam.

Vehicle is detected by the closing photocell, when working cycle is operating.

H.3	"Follow me" closing - Functions
0 (factory set up)	The function is OFF. The gate closes according to the automatic closing time set up.
1	The gate closes 2 seconds after completing the opening, if vehicle is detected.
2 ... 10	The gate closes when vehicle is detected, no matters if opening is completed, according to the delay time set, from 2 to 10 seconds.

H.4 Automatic closing after power cut

If you set **H.4** to 1, in case of power cut the gate will close 15 seconds after power is restored. Factory value is 0.

This function can be activated only if conditions included in [Chapter 4.1.2](#) page 7 are applied.

H.6 Master/slave configuration

This parameter allows to set up TWINNING feature in case of a double gate installation (mirror motors).

It is necessary to plug the optional interface card.

H.6	Master/slave (TWINNING) configuration
0 (factory set up)	TWINNING = OFF
1	Set 1 to configure the master gearmotor.
2	Set 2 to configure the slave gearmotor.

5.3.5 L. Working times

L.1 Automatic closing

This parameter sets the automatic closing time, adjustable from 0 = automatic closing OFF to 99 seconds.

L.2 Pedestrian automatic closing

This parameter sets the automatic closing time for PED opening, adjustable from 0 = automatic closing OFF to 99 seconds.

L.1 and **L.2** are totally independent one to the other: they can be set up in different ways with different times.

Also **L.1** can be **ON** while **L.2** can be OFF, and viceversa.

L.3 Pedestrian opening

This parameter sets the pedestrian opening width expressed in decimeters.

5.3.6 P. Safety devices

P.1 STOP

The factory setting is **0 = output OFF**.

If you wish to connect a stop device, set **P.1** to 1 position.

P.2 CL (RX) - Closing photocell

Closing photocell can be set up in the following ways:

P.2	CL (RX) Output
0	Output is OFF, the closing photocell is not activated.
1	Closing photocell is working without test.
2 (factory set up)	Closing photocell is working with test at every duty cycle.

The photocell test is a safety provision that helps detecting a faulty or unsafety photocell.

The test works as follows: before closing, the control unit switches the power off from +TX photocell terminal, in this way the photocell has no other option but to open the contact.

If the contact doesn't open in short time, it means the photocell is faulty and the gate remains still.

P.3 OP (RX) Opening photocell

Opening photocell can be set up in the following ways.

P.3	OP (RX) Output
0 (factory set up)	Output is OFF, the opening photocell is not activated.
1	Opening photocell is working without test.
2	Opening photocell is working with test at every duty cycle.

P.4 CL (EDGE) – Closing safety edge

Closing safety edge can be set up in the following ways:

P.4	CL (EDGE) Output
0 (factory set up)	No safety edge is wired. The output is OFF.
1	Safety edge wired as N.C. contact.
2	8K2 Safety edge.

P.5 OP (EDGE) – Opening safety edge

P.5	OP (EDGE) Output
0 (factory set up)	No safety edge is wired. The output is OFF.
1	Safety edge wired as N.C. contact.
2	8K2 Safety edge.

5.3.7 U. Maintenance configuration (for installers only)

U.1 Cycles counter

This feature allows to display the overall cycles performed.

No possibility of reset.

Cycles are displayed 2 by 2 figures in the following way: ex. if the gate totally performed 823.605 cycles, the screen will read:

00. 82 36 0.5.

Use \oplus to scroll on the figures.

U.2 Cycles performed since last maintenance service

This feature allows to display the overall cycles performed since last maintenance service.

Cycles can be reset when a maintenance service has been carried out (if **U.3** is updated and set up).

If you wish to reset press \oplus and \ominus together holding for 3 seconds: display will flash “**99**” to confirm reset successfully completed.

U.3 Maintenance countdown

This feature allows to set the number of cycles till next maintenance service (starting from a minimum of 1000 cycles and so on).

U.3 will accordingly and automatically update **U.1** and **U.2** if activated, at every closing operation.

It is also possible to warn the end user that maintenance service is needed.

To set this function, set parameter **U.4**.

U.4 Maintenance recall signalling mode

As previously explained in parameter **U.3**, it is possible to set a visible flashing “maintenance recall”.

Refer to the below table to set the desired recall configuration:

U.4	Maintenance recall – signalling configuration
0 (factory set up)	OFF – factory setting No maintenance recall has been activated.
1	SPECIAL FLASHING DURING AUTOMATIC CLOSING TIME. When the gate is opened, flashing light permanently blinks. To activate this mode the automatic closing time shall be set no less than a couple of seconds, otherwise signalling will not be sufficiently visible.
2	SPECIAL FLASHING DURING OPENING When gate is opening, the flashing light permanently blinks (instead of slow regular blinking).
3	AUX OUTPUT AUX output activates (the contact closes) when maintenance service is needed. Otherwise AUX contact remains opened.

U.5 Installation date

This feature allows to load the installation date.

The display will show the installation date in 3 different steps: the first figure shown is the day (from 1 to 31); pressing \oplus the month shows up (from 1 to 12); pressing again \oplus the year shows up with two dots.

Pressing again \oplus the sequence RESTARTS.

EX.: if your installation date is 14-03-2019 the sequence displayed will be:

14. 03 1.9.

If you wish to set the installation date, press together \oplus and \ominus holding during 4 seconds; screen will read “d”, use \oplus and \ominus to load the day, from 1 to 31; save pressing \ominus .

Screen will read “n”, use \oplus and \ominus to load the month; save pressing \ominus .

Screen will read “Y”, use \oplus and \ominus to load the year; save pressing \ominus .

Installation date loading completed.

U.6 Trouble shooting and "dead man" functions

Set **U.6** and press **+** to confirm.

This feature allows to display the status of all inputs and at the same time allows to command direct the gate in "dead man" mode (key permanently pressed).

Press (and hold) **+** to open the gate and **-** to close it.

Release the key to stop the gate.

Attention: during all these operations, **safety devices are not working, be carefull.**

The screen displays the status of every single input, everyone identified by a symbol.

If the input is "active" the according symbol will be lit.

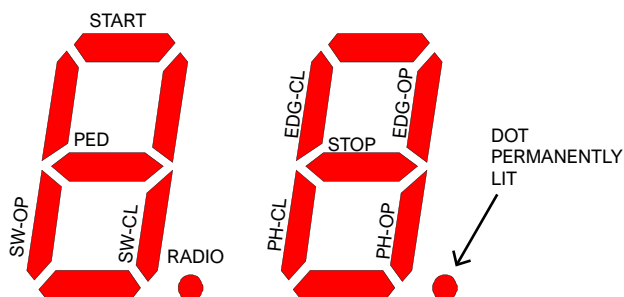

The symbol on the left outlines commands and limit switches (SW-OP and SW-CL stand for opening and closing limit switch).

If the input is active the symbol is lit.

Radio dot lights up when receiving a radio signal, saved or unknown.

The symbol on the right outlines safety devices; **PH-CL** and **PH-OP** stand for closing and opening photocells; **EDG-CL** and **EDG-OP** stand for closing and opening safety edge.

If the input is not active the symbol is lit (the safety device doesn't allow any operation).

If one of the **P** settings is **OFF** (Chapter 5.3.6 page 12), the screen will not show any status (symbol permanently switched off).

The red dot on the right remains permanently lit to confirm programming is ON.

If you wish to quit press **P** and **S** together.

6. DISPLAY

The display shows any gate status.

If no key is pressed, after 8 hours the display switches off; shortly press any key to light the display up.

As soon as control unit is powered, the display reads "8.8." (all segments are lit so as to detect a possible fault).

After that, the display reads firmware version (ex. "1.0", or "2.3" and similars), then "N" (2500 kg) or "H" (high speed) version.

As last step, control unit goes to **STAND-BY** mode and display reads "--" flashing.

The remaining messages are listed in the below table.

6.1 Messages

During normal operation messages may show up.

Refer to the below table indicating possible messages and according meaning:

Messages	Meaning
Vertical segments that move from center outwards	Gate is opening
Vertical segments that move from center inwards	Gate is closing
-S (start)	Receiving a START command
-P (pedestrian)	Receiving a PED command (pedestrian)
-H (halt / stop)	Receiving a STOP pulse
PC (photo close)	Closing photocell is operative
PO (photo open)	Opening photocell is operative
LO (limit open)	Opening limit switch is reached
LC (limit close)	Closing limit switch is reached
bo (border open)	Opening safety edge is active
bc (border close)	Closing safety edge is active
Pair of figures (es. 02)	Showing a saved remote control (ex.: remote control saved on radio position 2). Usually -S or -P show up to confirm which kind of remote control has been used.
-c	A timer has been wired to START or PED, automatic closing is stopped.

6.2 Fault

The display shows faults and anomalies that may stop the gate operation: the fault message is coded with two "dots" matched to figures or letters.

Refer to the below table:

DISPLAY message	Fault
oE (obstacle encoder)	Obstacle detected due to a sudden slow-down during working cycle
oA (obstacle amperometric)	Obstacle detected due to a sudden increase of gearmotor voltage.
oS (obstacle stall)	Obstacle detected due to gearmotor stop
oC (obstacle exceeding voltage)	Obstacle detected due to exceeding gearmotor voltage (limit rate reached)
PO (photo open)	Opening photocell operating
PC (photo close)	Closing photocell operating
AH (abort halt/stop)	STOP pulse
AU (abort user)	Operation interrupted using onboard keys
FC (test photo close failed)	Test detected a faulty closing photocell
FO (test photo open failed)	Test detected a faulty opening photocell
EC (voltage)	Exceeding voltage absorption (gearmotor)
EY (temperatura)	Component overheating
EF (fail)	Gearmotor fails to start up
EL (limit switch)	Limit switch doesn't cut
ES (switch)	Limit switch error: both limit switches are active
EU (timeout)	Duty cycle exceeded time allowed
EN (encoder)	Gearmotor and/or encoder are not properly wired



Proteco S.r.l. Via Neive, 77
12050 CASTAGNITO (CN) ITALY
Tel. +39 0173 210111 - Fax +39 0173 210199
info@proteco.net - www.proteco.net