

> Micro KIT

Micro KIT - CAMPO DI APPLICAZIONE APPLICATION FIELD



Finestre a sporgere
Top hinged windows



Finestre a vasistas
Bottom hinged windows



Finestre a bilico
Pivot windows

L'attuatore deve essere installato all'interno dell'edificio
The actuator has to be installed indoor



Micro KIT - DESCRIZIONE DI CAPITOLATO DESCRIPTION OF SPECIFICATIONS

MINGARDI Attuatore elettrico lineare con movimento a catena articolata contenuta all'interno dell'involucro. Funzionamento con tensione di alimentazione 230V AC 50Hz. Conforme alle Direttive Europee di riferimento. Dotato di sistema di fine corsa elettronico in apertura e chiusura. Corsa selezionabile mediante magnete. Collegabile elettricamente in parallelo. Colori disponibili: nero (N) - grigio (G) - bianco (B).

MINGARDI electric linear actuator with articulated chain movement contained inside the enclosure. Operating voltage: 230V AC 50Hz. In compliance with the relevant European Directives. Outfitted with electronic limit switch system for opening and closing. Stroke can be selected using magnet. Possibility of electrical connection in parallel. Colours available: black (N) - grey (G) - white (B).

Micro KIT - CARATTERISTICHE TECNICHE TECHNICAL FEATURES

Forza / Force	Spinta / Thrust: max 250N - Trazione / Tensile: max 250N
Voltaggio / Voltage	230V AC 50Hz
Corsa regolabile / Adjustable stroke	Si / Yes
Fine corsa apertura e chiusura / Limit switch opening and closing	Elettronico / Electronic
Grado di protezione (per uso interno) / Protection degree (indoor use only)	IP 20
Temperatura di funzionamento / Operating temperature	-10°C + 40°C

Micro KIT - 230V AC 50Hz

CODICE CODE	DESCRIZIONE DESCRIPTION	CORSA STROKE	SPINTA/TRAZIONE THRUST/TENSILE	POTENZA POWER	GRADO DI PROTEZIONE PROTECTION DEGREE	VELOCITA' MIN. SPEED MIN.	COLORE COLOR	STAFFA DI SUPPORTO SUPPORT BRACKET
2700810	Micro KIT	max 400 mm	max 250 N	135 W	IP 20	ca. 20 mm/s	Nero / Black	Nera / Black
2700811	Micro KIT	max 400 mm	max 250 N	135 W	IP 20	ca. 20 mm/s	Grigio / Grey	Nera / Black
2700812	Micro KIT	max 400 mm	max 250 N	135 W	IP 20	ca. 20 mm/s	Bianco / White	Nera / Black

I valori prestazionali riportati nella tabella sono valori medi verificati in condizioni di utilizzo standard / The values indicated on the table are average values were recorded in condition of normal use

Micro KIT - DIMENSIONALI DIMENSIONS

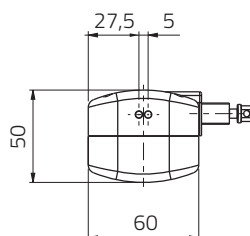
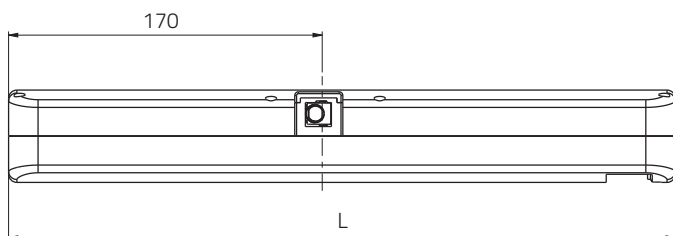

Micro KIT - LUNGHEZZE LENGTHS

Corsa / Stroke max 400 mm L = 362 mm

Micro KIT - CONFIGURAZIONE IMBALLO PACKAGE CONFIGURATION

- Attuatore
Actuator
- Staffa per applicazione a sporgere con accessori
Bracket for top-hinged windows with accessories
- Staffa per applicazione a vasistas
Bracket for bottom-hinged windows
- Staffa unica basculante
Single pivoting bracket

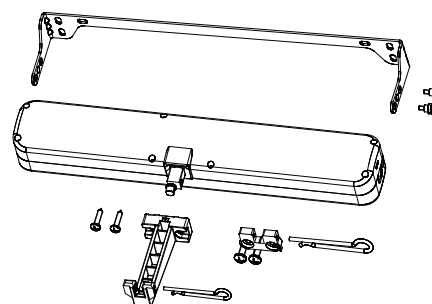

> Micro KIT



Corpo attuatore in plastica.
Nero - Grigio - Bianco
 Plastic actuator casing.
 Black - Grey - White

KIT Staffe per applicazione su finestre a sporgere e a vasistas
 KIT Brackets for top hinged windows and bottom hinged windows

Applicabile ad ogni tipo di sormonto e altezza del serramento grazie alla staffa unica basculante che permette 6 diverse posizioni di applicazione.
 Suitable to any type of profile and window height, thanks to the single pivoting bracket with 6 different fixing positions.



Micro KIT - ACCESSORI DI FISSAGGIO FIXING ACCESSORIES

CODICE CODE	DESCRIZIONE DESCRIPTION
2700855	Staffa unica basculante (confezione minima 5 pezzi) / Single pivoting bracket (package minimum 5 pieces)
2700898	Staffa per applicazione a sporgere con accessori / Bracket for top-hinged windows with accessories
2700899	Staffa per applicazione a vasistas con accessori / Bracket for bottom-hinged windows with accessories

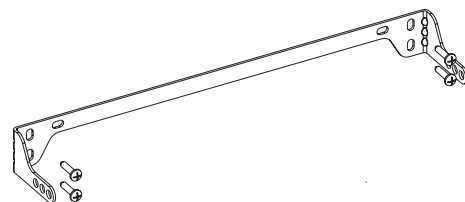
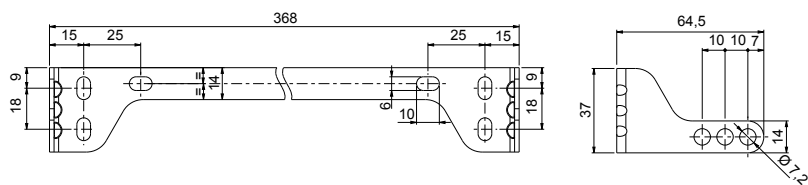

2700855

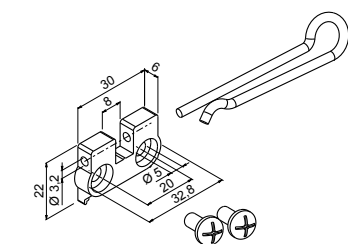

2700898

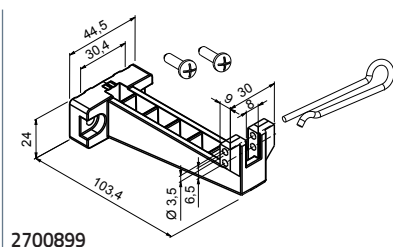

2700899