

FAAC® 844 MP

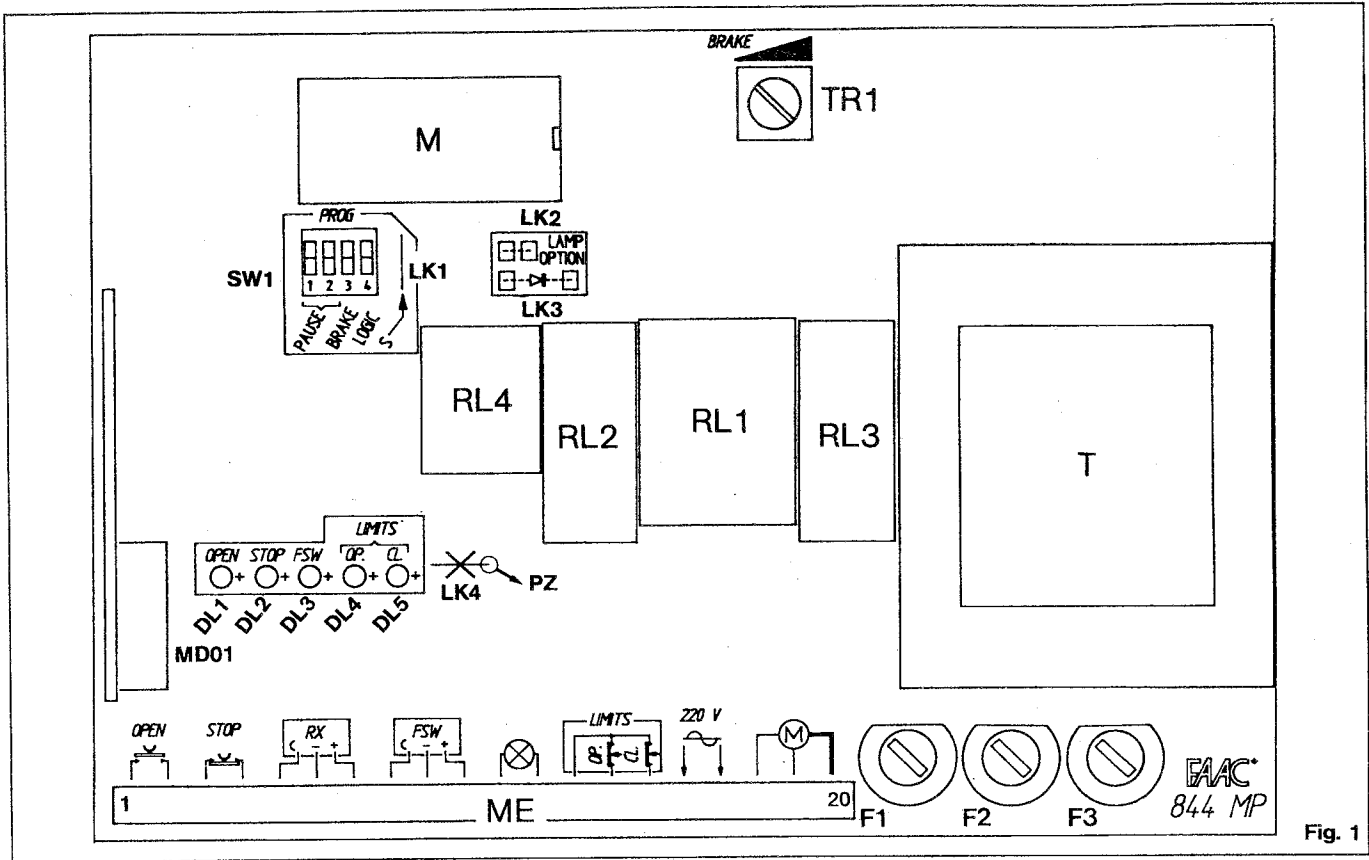

Fig. 1

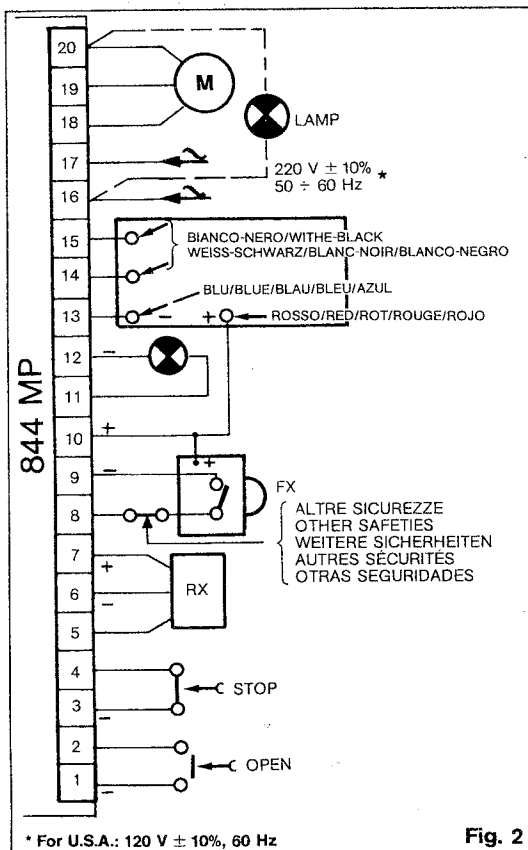

Fig. 2

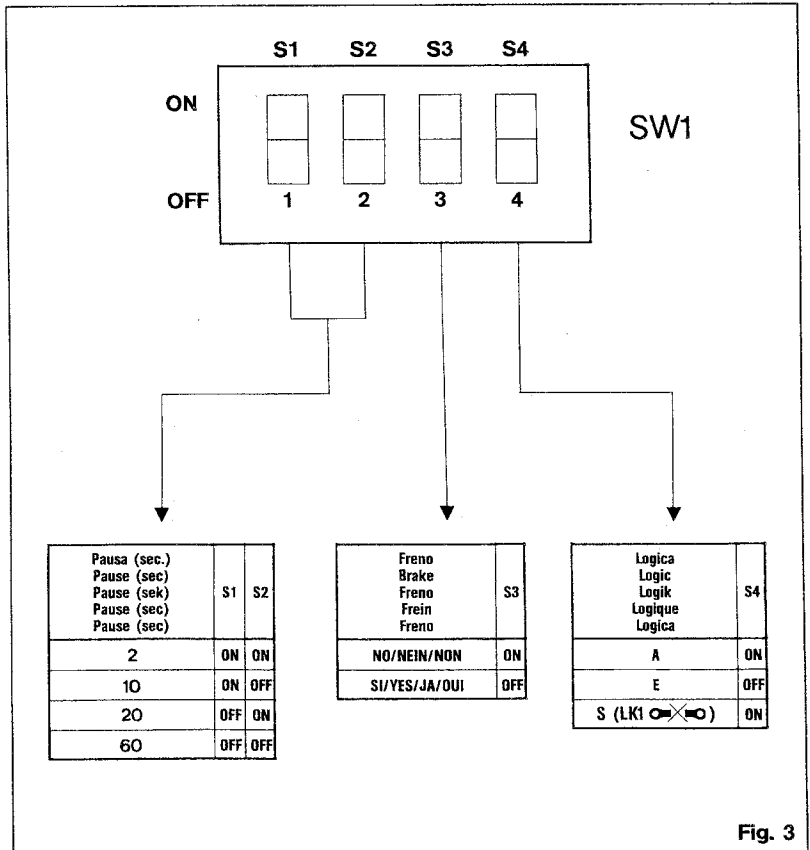
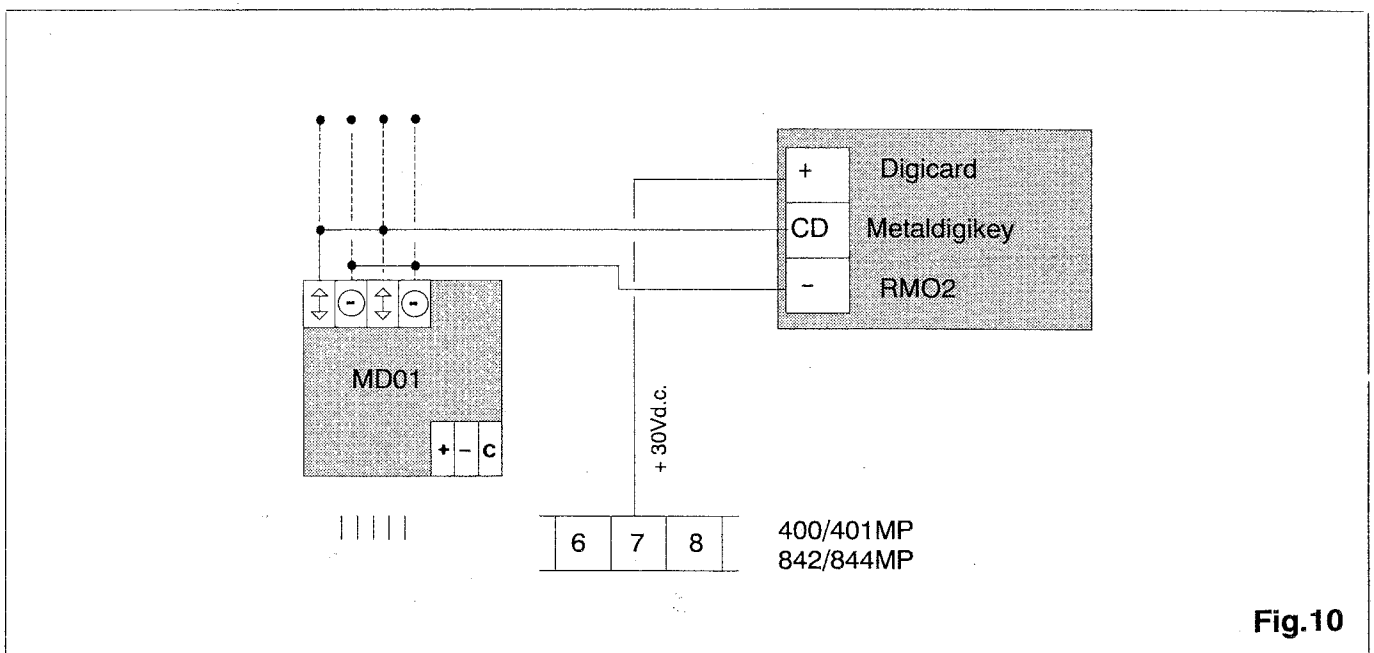
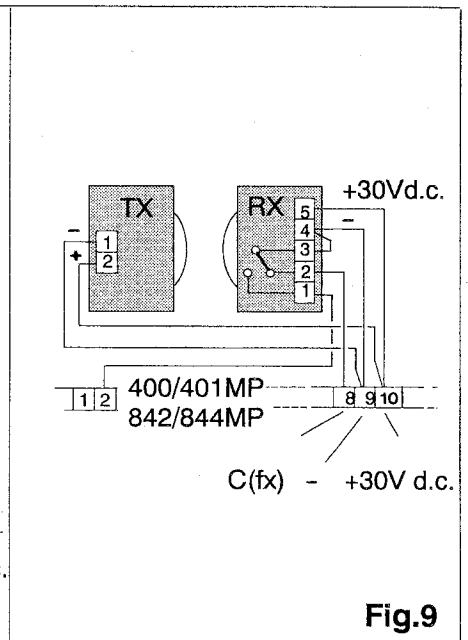
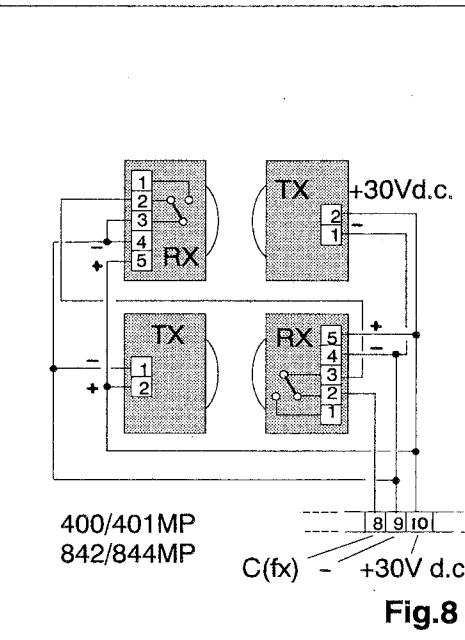
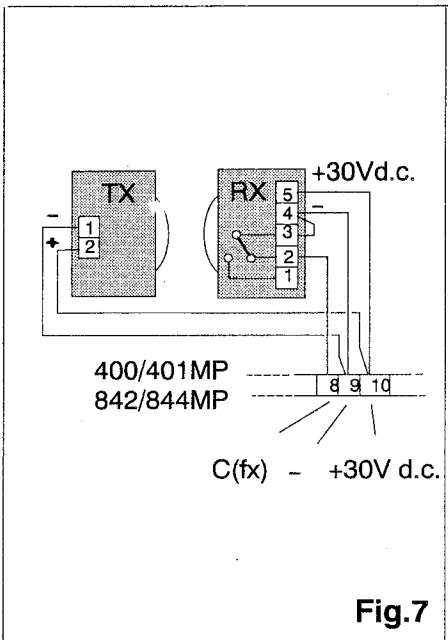
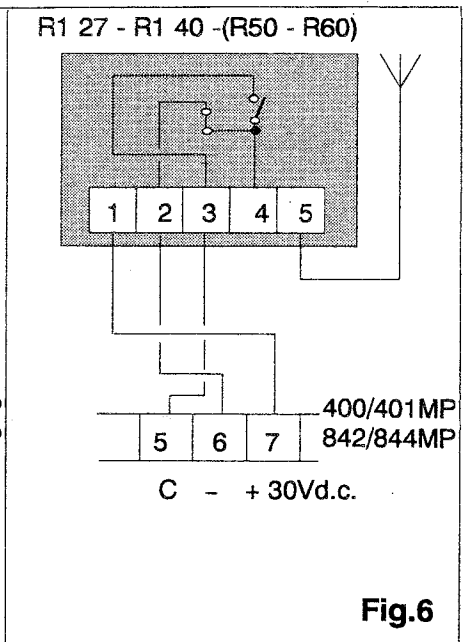
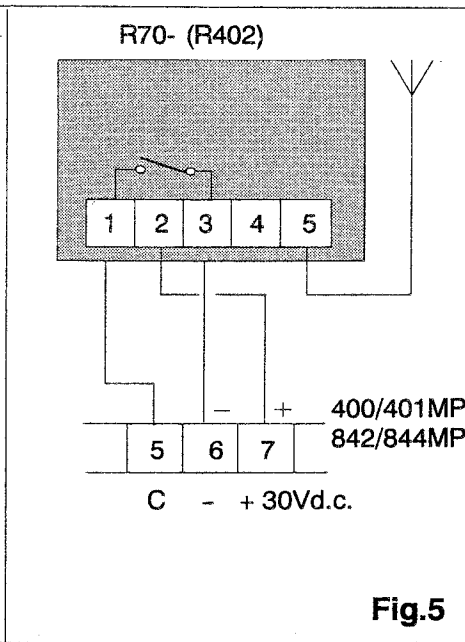
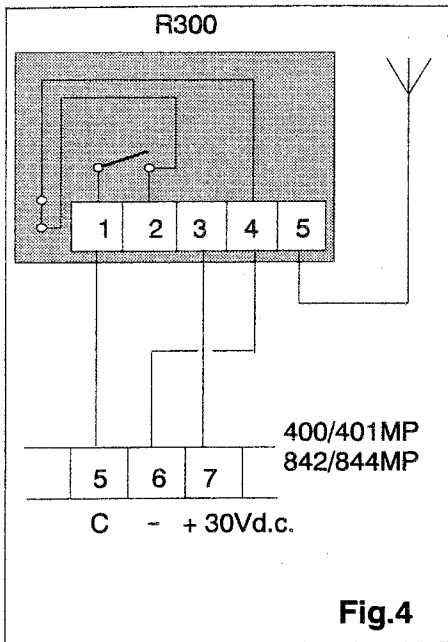

Fig. 3



PREDISPOSIZIONE SCHEDA MD01 (FIG. 10)

L'apparecchiatura FAAC 844 MP è predisposta per l'inserimento della scheda MD01. La scheda MD01 funziona sia con il lettore di chiavi magnetiche DIGICARD, che con il combinatore a tastiera METAL DIGIKEY che con la ricevente pluricanale RM02. Tale dispositivo può essere applicato all'apparecchiatura 844 MP tramite il connettore MD01 di figura; la scheda MD01 dispone anche di una morsettiere per il collegamento ad altre apparecchiature e di un ingresso/uscita per i segnali in codice per i succitati datori di impulso.

LEDS LUMINOSI

Le apparecchiature FAAC 844 MP sono dotate di una serie di leds per il controllo

del funzionamento degli ingressi: (pulsante apre, DL1 - pulsante di stop, DL2 - fotocellule, DL3 - fine corsa apertura, DL4 - fine corsa chiusura, DL5).

Funzionamento

I leds sono illuminati quando il contatto sulla morsettiere è chiuso, ciò significa che gli ingressi con contatto N.C. (Stop, DL2 - fotocellule, DL3 - F.C. apertura, DL4 - F.C. chiusura, DL5) hanno il rispettivo led acceso e si spegne quando l'ingresso viene impegnato; gli ingressi con contatto N.A. (pulsante apre o contatto radiocomando, DL1) hanno il rispettivo led spento e si accende quando l'ingresso risulta impegnato.

GB THE FAAC 844 MP CONTROL UNIT GB

TECHNICAL DATA

Power supply	: 220 V ± 10%, 50-60 Hz *
Power available for a warning lamp	: 5 Watts 24V AC Max
Power available for other external accessories	: 4 Watts max.
Motor supply	: 650 Watts max.
Operating temperature	: -25°C to +85°C

COMPONENT DESIGNATIONS (REF FIG. 1)

M	= The FAAC microprocessor
DL1	= "Open" LED
DL2	= "Stop" LED
DL3	= "Photocell" LED
DL4	= "Open Limit" LED
DL5	= "Close Limit" LED
SW1	= Dip switch assembly
TR1	= Brake adjustment
T	= Transformer 35 VA
RE1	= Power relay
RE2	= Direction relay
RE3	= Brake relay
RE4	= Lamp relay (contact rating 0.5 A 40 V)
ME	= Plugable Terminal Strip
MD01	= Connector for board MD01
F1	= 5 Amp QUICK-BLOW Fuse, mains input to unit
F2	= 250mAmp ANTI-SURGE Fuse, DC internal supply
F3	= 1 Amp ANTI-SURGE Fuse, accessories supply
LK1	= "S" Logic option wire link
LK2	= Warning lamp option wire link
LK3	= Warning-lamp option, diode link
LK4	= Wire link to provide a free set of relay contact instead of warning lamp function
PZ	= A point on the solder side of the board corresponding to one side of the free set of relay contacts which are available instead of the warning lamp function (Ref. LK4).

Danger: Mains voltage is present on the control unit assembly. Observe safety practice to avoid electric shock. The equipment should be installed and serviced by qualified personnel ONLY.

TERMINAL STRIP WIRINGS (REF. FIG. 2)

- 1) Common (-)
- 2) "Open" Signal (N.O.)
- 3) Common (-)
- 4) "Stop" Signal (N.C.)
- 5) Radio receiver signal (N.O.)
- 6) Common (-)
- 7) +30 V DC
- 8) Safety contacts (N.C.)
- 9) Common (-)
- 10) +30 V DC (red wire, limit switch power supply)
- 11) Warning lamp (24 Vac, 5 W)
- 12) Common (-)
- 13) Common Limit - blue cable
- 14) Open Limit } white and black cables
- 15) Close Limit }
- 16) Mains power supply 220 V ± 10%, 50-60 Hz *
- 17) Mains power supply 220 V ± 10%, 50-60 Hz *
- 18) Motor forward } black & brown cables
- 19) Motor backward }
- 20) Motor common - blue cable

* For USA: 120 V ± 10%, 60 Hz

WIRING

The FAAC 844 MP control unit provides a 20 way plugable terminal strip (screw terminals) for external connections to unit.

POWER SUPPLY

220 V ± 10%, 50/60 Hz single phase, if it is necessary to use a 220 V 3 phase supply, use 2 phases only or in the case of 380 V 3 phase supply, use one phase and neutral. The mains power cables (power supply and motor connections) must be routed separately from the low voltage control signal cables (photocell, buttons, receiver etc.) and throughout the installation wiring practice in accordance with proper safety and reliability standards must be employed.

Warning: a 16 Amp isolation switch must control the mains supply to the control unit. Also a 4 Amp fuse or a 6 Amp trip switch must be fitted.

NOTE: if the stop button and/or photocells are not fitted, fix a wire link between the relevant terminals (3 with 4 and/or 8 with 9).

PROGRAMMING

The FAAC 844 MP control unit has a Dip-switch assembly and 5 wire links by which the system is programmed.

PROGRAMMABLE FUNCTIONS

- 1) Operating Logic
- 2) Open/Close times
- 3) Pause times
- 4) Electronic braking
- 5) Warning light operating logic

Warning: before resetting the Dip-switches, erase the memory of the previous setting from the FAAC micro-processor by momentarily switching off the power.

1) OPERATING LOGIC

The system can be operated in one of three logic modes:

- Logic mode **A** : "Automatic"
- Logic mode **E** : "Semiautomatic"
- Logic mode **S** : "Safety"

The logic modes can be set by means of **S4** on the Dip-switch assembly (Ref. fig. 3). To obtain the "S" logic mode, set **S4** to the **ON** position and cut wire link **LK1** (Ref. Fig. 1).

"A" LOGIC MODE: "AUTOMATIC"

When an open signal is sent (i.e. from a transmitter or open button), the gate opens up to the limit switch, pauses for the preselected pause time and then closes. If another open signal is sent while the gate is opening, it is disregarded and the gate continues to open.

If the open signal is sent during pause, pause time is reset and starts again from zero. If the signal is sent while the gate is closing, the gate reverses and opens again.

"E" LOGIC MODE: "SEMI-AUTOMATIC"

The open button or the transmitter provide control as follows:

- The first signal commands open.
- The second signal commands stop.
- The third signal commands close.
- If the signal is sent while the gate is open, on the limit switch, the gate closes.
- If the signal is sent while the gate is closing, the gate reverses.

"S" LOGIC MODE: "SAFETY"

The safety logic mode works the same as the automatic logic mode with the exception that if the signal is sent while the gate is opening, the gate reverses, closing without a pause period; if a signal is sent while the gate is open (during pause time) pause time is cancelled and the gate starts closing immediately.

2) OPEN/CLOSE TIME SELECTION

The normal open/close time is adjusted by a group of electronic limit switches. For safety purposes the equipment is already programmed to provide an open/close time of **240 seconds**, if the gate is physically obstructed during opening or closing, power to the motor is automatically switched off.

3) PAUSE TIME SELECTION

Dip-switches **S1** & **S2** of **SW1** are used to select one of 4 different pause times, minimum **2 seconds**, maximum **60 seconds** (fig. 3).

4) ELECTRONIC BRAKING

The electronic braking function can be excluded by setting **S3** of **SW1** to the **ON** position. This braking function must be excluded in installations using 3 phase 380V geared motors. To use the braking function on motors other than the FAAC 844 motor, contact the FAAC "Customer Service" for information and advice.

5) WARNING LIGHT OPERATING LOGIC

The FAAC 844 MP control unit has a warning light supply 24 V AC, 5 watts (fig. 1-2-3). The light may be operated in one of the following logic modes:

- Standard warning light operation (LS):**
 - Warning light **ON**: Gate opening - gate open.
 - Warning light **FLASHING**: Closing warning (5 seconds before closing) - gate closing. Warning light **OFF**: Gate closing.
- By inserting a diode **1N4007** in place of **LK3** the warning light operates as per the following logic mode:
 - Warning light **ON**: Gate opening - pause time - gate closing.
 - Warning light **FLASHING**: Closing warning (5 seconds before closing).
- By inserting a diode **1N4007** in place of **LK3** and inserting **LK2**, the logic mode is such that... Warning light **ON**: Gate closing.

NOTE: Removing wire link **LK4** provides a free set of relay contacts on RL4 instead of the warning light function.

This free set of contacts (normally open) terminate at terminal **11** of terminal strip **ME** and a point on the solder side of the control unit board corresponding to one side of **LK4**, **PZ**.

Also, this free set of normally open contacts can operate in the same logic modes as the warning light. Ref. (a) (b) & (c) above. The contact ratings are **0.5 A 30 V DC**, suitable for low voltage only and are protected by spark quenching circuit.

OPERATION OF THE SYSTEM

Open Button

The OPEN button must be of the "normally open contact" type (i.e. press to make button, radio receiver or other). If a short circuit fault condition occurs on the OPEN button the system operates on open-close-stop routine only. The system will not respond to any further commands until the fault condition is removed. **This ensure the gate remains closed in such a fault condition and applies to all operating modes.**

Figs. 4, 5 & 6 show the connections between the various models of radio receivers and the FAAC 844 MP control unit terminal strip.

Stop Button

The STOP button must be of the "normally closed contact" type. Pressing the STOP button stops the gate at any point of its operation. If another signal is sent after the stop button is pressed, the system gives a **5 second warning** (warning

light flashes) and starts closing the gate. For safety purposes a STOP button must always be fitted.

Photocell

The FAAC 844 MP control unit can supply 30 V DC to a photocell system. This system must present a **normally closed set of contacts** to the control unit. The photocell system must be ordered separately and although not mandatory in some countries, it should be installed for safety purposes.

Figs. 7, 8 & 9 show different methods of connecting the photocell receivers and transmitters:

Fig. 7, shows **one pair** of photocells wired for **safety purposes**.

Fig. 8, shows **two pairs of photocells** wired for **safety purposes**, **each one of the two receivers positioned, one each side of the gate**, to avoid interference from the adjacent infrared beam.

Fig. 9, shows **one pair of photocells** wired for **safety purposes** and to provide an "OPEN" signal.

Photocell safety function

While the gate is closing, the photocell signal reverses the direction of the gate. While the gate is opening, the photocell signal is disregarded. During pause time, the photocell signal cancels pause time: the control unit gives 5 seconds warning (warning light flashes) and starts closing the gate (only for A and S automatic logic).

ELECTRONIC BRAKING

The FAAC 844 MP features adjustable electronic braking. The braking time is adjusted by the potentiometer TR1, which in turn determines the braking distance.

NOTE: the braking action is independent of supply voltage and motor load (i.e. gate weight, lubrication, adjustment, etc.).

"CODED INPUT" DEVICE MD01 (OPTIONAL)

If it is required to operate the system by means of a **DIGICARD** unit or a **DIGIKEY** unit or multichannel radio receiver module **RM02**, a "coded input" device **MD01** is available on request. The device may be mounted on the control unit by means of the 5 way plug MD01, alternatively it can be connected externally by means of a 3 way terminal strip provided (screw type). It features also a terminal strip (screw type) for input/output of coded signals (Ref. fig. 10).

LED DISPLAY

The FAAC 844 MP control unit displays LED's which indicate system functions.

RADIO or OPEN Signal DL1
STOP Signal DL2
Photocell Signal DL3.

Operation

A led comes on when the contacts of its associated input are closed and off when the contacts of its associated input are open. Thus as input with **normally closed** contacts (**STOP, DL2 & Photocell DL3**) has an associated led normally on, which goes off when the input is activated. The input with **normally open** contacts (**RADIO and OPEN DL1**) has an associated led normally off which goes on when the input is activated.

D	STEUERUNG FAAC 844 MP	D
----------	------------------------------	----------

ALLGEMEINE MERKMALE

Versorgung	: 220 V ± 10%, 50-60 Hz
Max Leistung der Signallampe	: 5 W bei 24 V Ws.
Max Leistung des weiteren Außenzubehörs mit Gleichstromversorgung	: 9 W
Max Belastbarkeit der Motoren	: 650 W
Betriebstemperatur	: -25°C + +85°C

BESTANDTEILE DER (ABB. 1)

M	= Mikroprozessor FAAC
DL1	= Led Öffnungstaster
DL2	= Led Stoptaster
DL3	= Led Photozelle (Sicherheit)
DL4	= Led Endschalter Öffnen
DL5	= Led Endschalter Schließen
SW1	= Mikroschaltergruppe
TR1	= Trimmer, Bremsverstellung
T	= Transformator 35 VA
RE1	= Relais Motor
RE2	= Relais Fahrrichtung
RE3	= Relais Bremse
RE4	= Relais Signallampe (Leistung des Kontaktes: 0,5 A bei 30 V GS)
ME	= Herausziehbare Klemmenleiste
MD01	= Stecker für MD01 Platine
F1	= FLINKE 5A sicherung (NETZ)
F2	= TRAGE 250mA sicherung (GS-versorgung der Vorrichtung)
F3	= TRAGE 1A sicherung (versorgung der Zubehör)
LK1	= Brücke Logik S
LK2	= Brücke-option, Kontrolleuchte
LK3	= Diode-option, Kontrolleuchte
LK4	= Brücke Wahl freiem Relais statt Signallampe
PZ	= Plätzchen für den potentialfreie Kontakt der Signallamperelais (Kupferseite)

Vorsicht: Bei versorgter Steuerung steht das Geräteinnere unter Spannung; es sind daher die üblichen Sicherheitsvorschriften zu beachten, um elektrische Schläge zu vermeiden. Das Gerät ist ausschliesslich von qualifiziertem Personal zu installieren und zu kontrollieren.

ANSCHLÜSSE AN DIE KLEMMENLEISTE (ABB. 2)

- 1) Gemeinsam (-)
- 2) Öffnungstaster (Arbeitskontakt)
- 3) Gemeinsam (-)
- 4) Stoptaster (Ruhekontakt)
- 5) Funksteuerungskontakt (Arbeitskontakt)
- 6) Gemeinsam (-)
- 7) + 30 V Gs.
- 8) Sicherheitskontakt (Ruhekontakt)
- 9) Gemeinsam (-)
- 10) + 30 V Gs. (Rotes Kabel, Versorgung Endschalter)
- 11) Signallampe (24 W Ws. 5 W)
- 12) Gemeinsam (-)
- 13) Gemeinsam Endschalter - blaues Kabel
- 14) Endschalter Öffnen } Weißes und Schwarzes Kabel
- 15) Endschalter Schließen }
- 16) Versorgung 220 V ± 10%, 50-60 Hz
- 17)
- 18) Motor vorwärts } Schwarzes und braunes Kabel
- 19) Motor zurück }
- 20) Motor gemeinsam - blaues Kabel

ANSCHLÜSSE

Die FAAC Steuerung 844 MP ist mit einer abziehbaren Klemmenleiste mit 20 Klemmen (Schraubklemmen) für die externen Anschlüsse ausgerüstet.

SPANNUNGSVERSORGUNG

220V ± 10% - 50/60 Hz einphasig; im Falle von Netzversorgung 220V dreiphasig, sind 2 Phasen zu verwenden. Im Falle von Netzversorgung 380V dreiphasig, sind 1 Phase und der Nulleiter zu verwenden. Für die Leistungsanschlüsse (Spannungsversorgung, Motoranschlüsse) und Steueranschlüsse (Taster, Funkfernsteuerung, Photozellen etc.), sind getrennte Kabel zu verwenden.

Achtung: die Spannungsversorgung ist auf jeden Fall mit einem Einphasenschalter 16A mit 4A Sicherungen, bzw mit Automatikschaltern 6A abzusichern. (Die Anlage ist in jedem Fall gemäß den geltenden Sicherheitsvorschriften zu schützen).

Anmerkung: werden der Stoptaster und/oder die Photozellen oder andere Sicherheiten nicht angeschlossen, sind die entsprechenden Klemmen (3 mit 4 und/oder 8 mit 9) zu brücken.

PROGRAMMIERUNG DER FAAC STEUERUNG 844 MP

Die FAAC Steuerung 844 MP ist mit einer Mikroschaltergruppe und 5 Brücke zur Programmierung des Systems ausgerüstet.

PROGRAMMIERBARE FUNKTIONEN

- 1) Betriebslogiken
- 2) Öffnungs- und Schließzeiten
- 3) Pausezeiten
- 4) Elektronische Bremsung
- 5) Betriebslogiken der Signallampe

Achtung: Jedes mal, daß man die Programmierung der Steuerung ändern will, ist die Spannungsversorgung auszuschalten. (Damit wird das bisherige Programm auf Null gestellt).

1) BETRIEBSLOGIKEN

Mit dem FAAC Gerät 844 MP können die nachfolgenden Betriebslogiken angewählt werden:

- Logik A : "Automatik"
- Logik B : "Halbautomatik"
- Logik S : "Sicherheit"

Diese Betriebslogiken werden durch die Positionierung des Mikroschalters **S4** (Abb. 3) ausgewählt. **Die Betriebslogik S hat man mit Mikroschalter S4 auf ON und getrennter Brücke LK1 (Abb. 1).**

Logik A: "Automatik"

Bei Abgabe eines Impulses (durch Öffnungstaster oder über Fernsteuerung) öffnet sich das Tor bis zum Anschlag, bleibt für die Pausezeit geöffnet und schließt sich dann automatisch.

Während des Öffnens freigegebene impulse werden nicht angenommen und das Tor öffnet sich weiterhin.

Wird ein Impuls während der Pause freigegeben, so beginnt die Zählung der Pausendauer wieder von neuem.

Während des Schließens freigegebene Impulse steuern die Umkehr der Torbewegung.

Logik E: "Halbautomatik"

Wird ein einziger Öffnungstaster bzw. die Fernsteuerung betätigt, geschieht folgendes: der erste Impuls steuert die Öffnung; der zweite Impuls bewirkt das Stoppen; der dritte Impuls steuert das Schließen.

Während des Schließens freigegebene Impulse steuern die Umkehr der Gitterbewegung. Wird ein Impuls bei bereits geöffnetem Gitter und beendeteter Pausezeit freigegeben, so wird das Schließen gesteuert.

Logik S: "Sicherheit"

Die Logik S ist ähnlich der Logik A, mit dem Unterschied, daß bei Freigabe eines Impulses während der Öffnungsphase, das Gitter sofort schließt, ohne der Zyklus zu beenden. Während der Pausezeit freigegebene Impulse steuern das sofortige Torschließen.

2) WAHL DER ÖFFNUNGS-SCHLIESSZEITEN

Die normalen Öffnungs- und Schließzeiten sind verstellbar durch eine Gruppe von elektronischen Endschalter. Die Steuerung auf jeden Fall ist bereits mit einer fixen Sicherheitspausezeit von **240 Sek.** voreingestellt, nach deren Verlauf die Motorversorgung automatisch unterbrochen wird.

3) WAHL DER PAUSEZEITEN

Durch Verstellung der Mikroschalter **S1** und **S2** der Gruppe **SW1** können 4 verschiedene Pausezeiten (**ab 2 Sek. bis 60 Sek.** - Siehe Abb. 3).

4) ELEKTRONISCHE BREMSUNG

Durch Verstellung des Mikroschalters **S3** kann das elektronische Bremssystem aus geschaltet werden (**S3 auf ON** - Siehe Abb. 3).

Dieses Verfahren wird gemacht, wenn die Steuerung 844 MP die Fernschalter einer Anlage mit Getriebemotor 380V dreiphasig steuert muß. Für Anwendungen ohne den FAAC844 Getriebemotor empfehlen wir, vorher mit dem FAAC Kunden-dienst Kontakt zu nehmen.