

Easy life
Link the world

manufacturer of
video door phone



*Information & specifications contained in this manual maybe be changed for the benefit of product development and improvements.



INDEX

2-Wire Digital Villa Video Intercom System	1-19
2-Wire Apartment Video Intercom System	20-34
4-Wire AHD Villa Video Intercom System	35-50
4-Wire CVBS Villa Video Intercom System	51-55
CAT-5 CVBS/AHD Apartment System	56-66



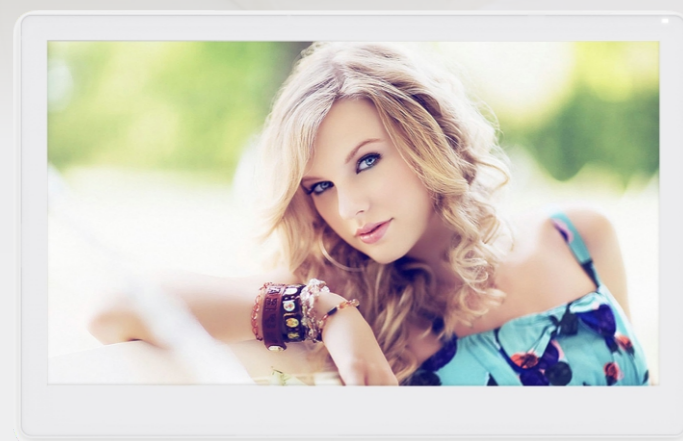

2-Wire Villa System

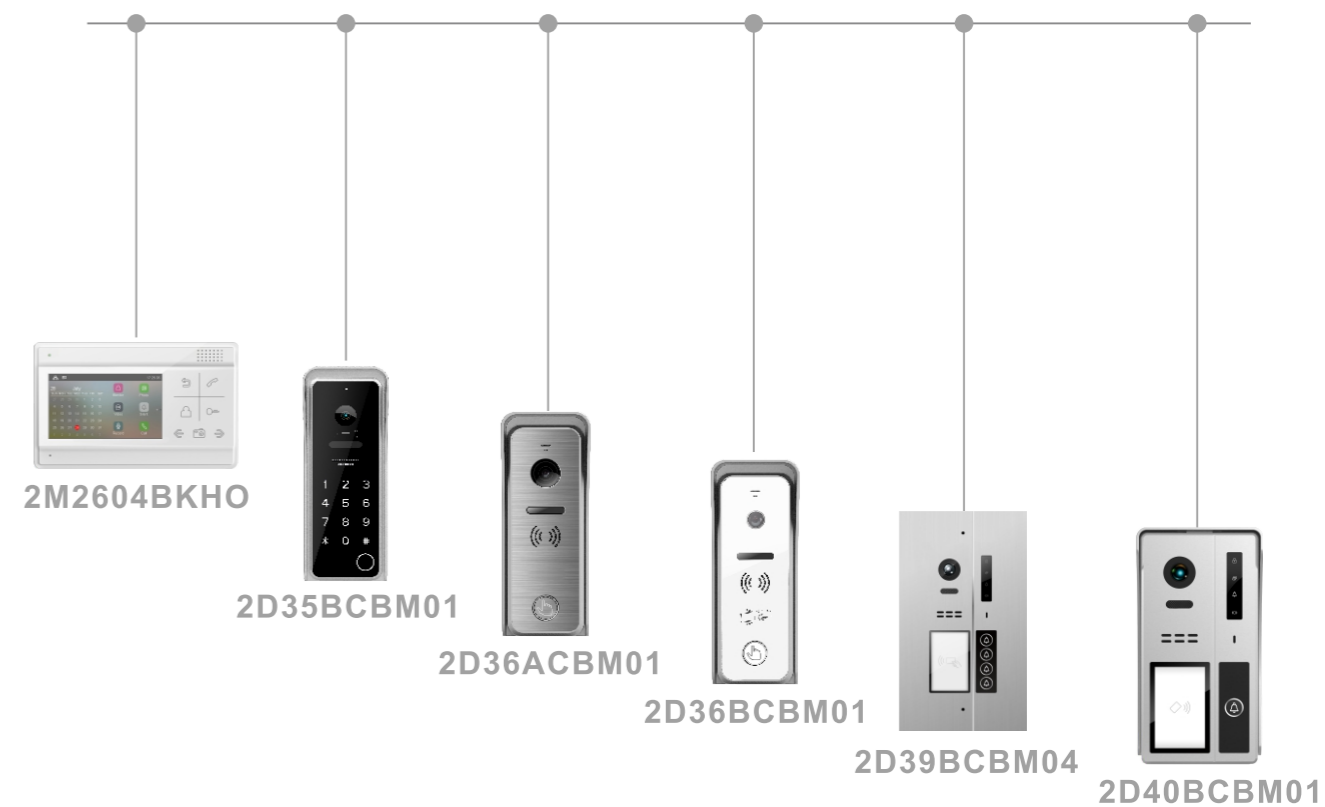
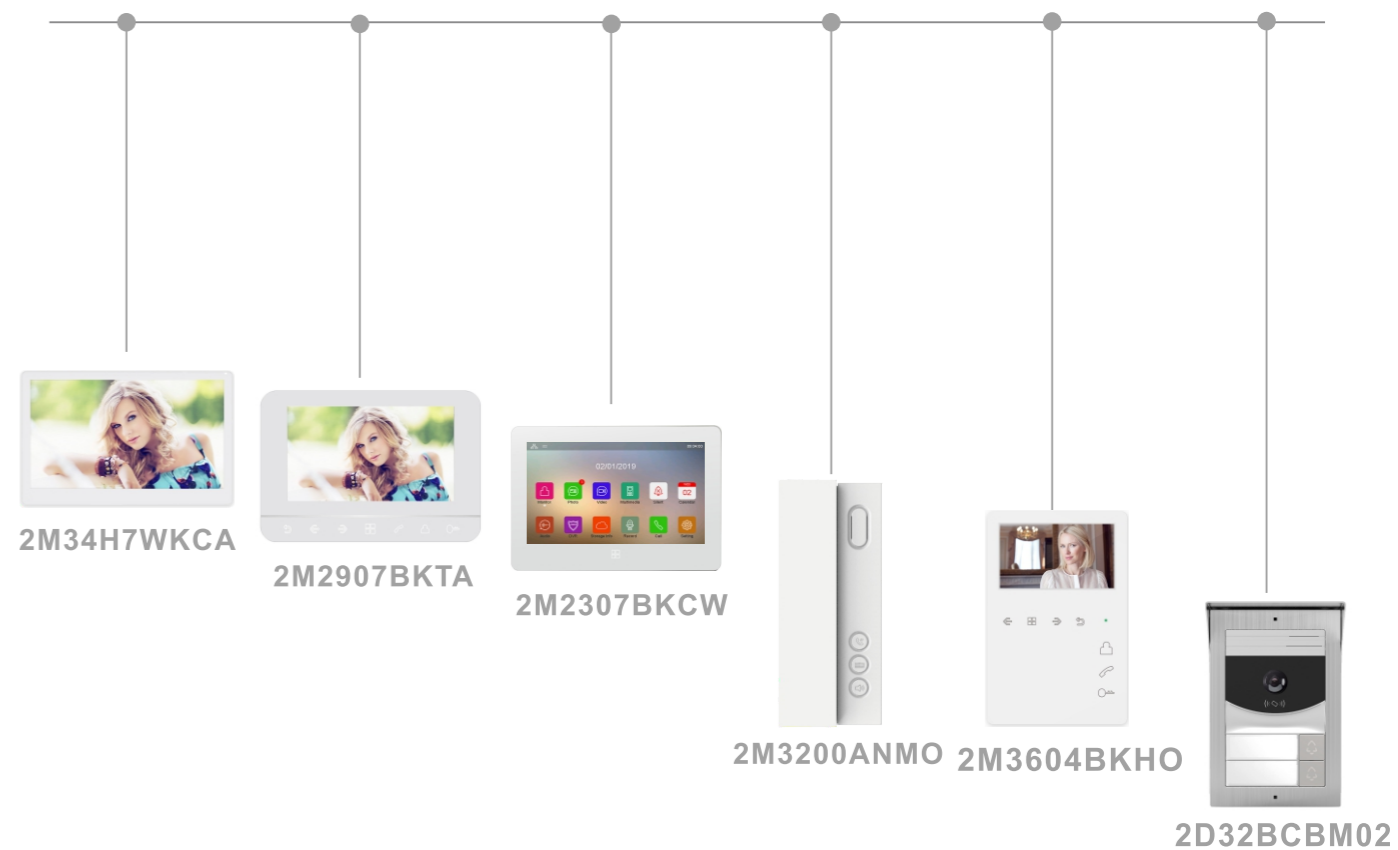

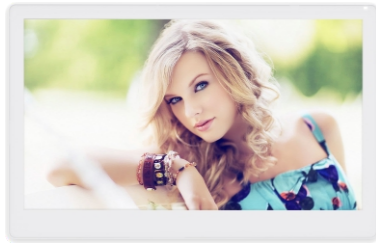

Model:2M34H7WKCA **New**

- 7 inch digital video door phone
- Fashion design, friendly use by touch screen



Model:2M2907BKCO/2M2907BKCA/2M2907BKCW

- 7 inch digital video door phone
- Premier design, friendly use by touch screen



Specification	2M34H7WKCA
Panel	7inchHD/IPSScreen
TFT resolution	1024*600
Connection/ Effective length	2-wire nonpolarity /100m
External memory card	Yes(8G-256G)
Power(rated Power/standby power)	DC15V-24V (4/1.5W)
Operation	Touch screen
Dimension	174.3*112*19.4mm
Features	
Lock control	Yes
Intercom transfer/ call/broadcast	Yes
DVR	Yes
Multimedia	Yes
Image capturing	Yes
Video/audio record	Yes
Calendar&alarm clock	Yes
Voice message	Yes
CCTV support	No
Wifi	Yes

Specification	2M2907BKCO	2M2907BKCA	2M2907BKCW
Panel	7" digital TFT LCD	7" digital TFT LCD	7" digital TFT LCD
TFT resolution	800*480	800*480	800*480
Connection/ Effective length	2-wire nonpolarity /100m	2-wire nonpolarity /100m	2-wire nonpolarity /100m
External memory card	Yes(8G-256G)	Yes(8G-256G)	Yes(8G-256G)
Power(rated Power/standby power)	DC15V-24V (4W/1.5W)	DC15V-24V (4W/1.5W)	DC15V-24V (4W/1.5W)
Operation	Touch screen	Touch screen	Touch screen
Dimension	208*143*23.5mm	208*143*23.5mm	208*143*23.5mm
Features			
Lock control	Yes	Yes	Yes
Intercom transfer/ call/broadcast	Yes	Yes	Yes
DVR	Yes	Yes	Yes
Multimedia	Yes	Yes	Yes
Image capturing	Yes	Yes	Yes
Video/audio record	Yes	Yes	Yes
Calendar&alarm clock	Yes	Yes	Yes
Voice message	Yes	Yes	Yes
CCTV support	No	Yes	No
Wifi	No	No	Yes

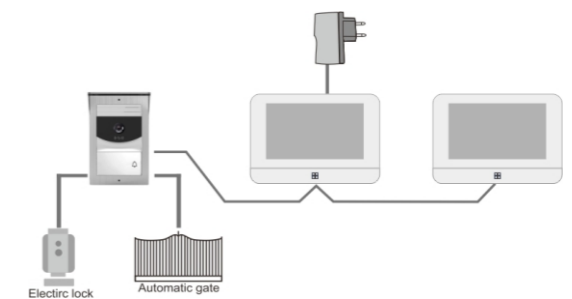
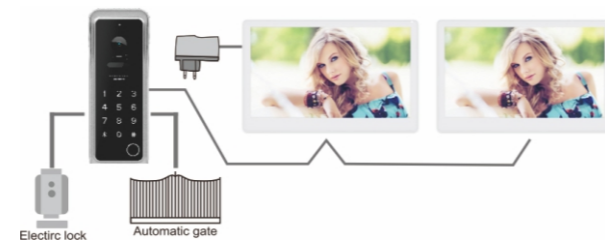

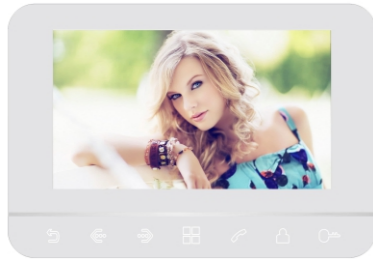

Model:2M2907BKTO

- 7 inch digital video door phone
- Fashion design, friendly use by touch button

Features:



Specification	2M2907BKTO
Panel	7" digital TFT LCD
TFT resolution	800*480
Connection/ Effective length	2-wire nonpolarity /100m
External memory card	Yes(8G-256G)
Power(rated Power/standby power)	DC15V-24V (4/1.5W)
Operation	Touch button
Dimension	208*143*23.5mm
Features	
Lock control	Yes
Intercom transfer/ call/broadcast	Yes
DVR	Yes
Multimedia	Yes
Image capturing	Yes
Video/audio record	Yes
Calendar&alarm clock	Yes
Voice message	Yes
CCTV support	No
Wifi	No

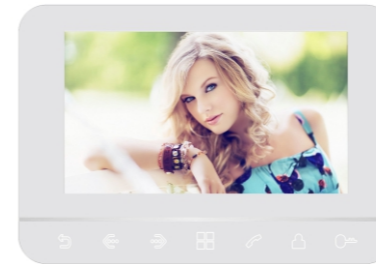
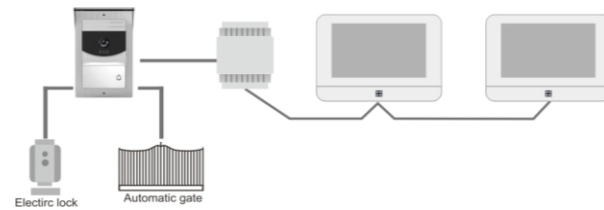

Model:2M2907BKTA

- 7 inch digital video door phone
- Fashion design, friendly use by touch button

Features:



Specification	2M2907BKTA
Panel	7" digital TFT LCD
TFT resolution	800*480
Connection/ Effective length	2-wire nonpolarity /100m
External memory card	Yes(8G-256G)
Power(rated Power/standby power)	DC15V-24V (4/1.5W)
Operation	Touch button
Dimension	208*143*23.5mm
Features	
Lock control	Yes
Intercom transfer/ call/broadcast	Yes
DVR	Yes
Multimedia	Yes
Image capturing	Yes
Video/audio record	Yes
Calendar&alarm clock	Yes
Voice message	Yes
CCTV support	Yes
Wifi	No

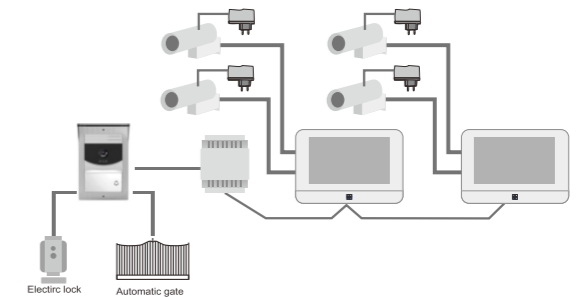



Model : 2M2307BKTO

- 7 inch digital video door phone
- Fashionable design, friendly use by touch button



Specification	2M2307BKTO
Panel	7" digital TFT LCD
TFT resolution	800*480
Connection/ Effective length	2-wire nonpolarity /100m
External memory card	Yes(8G-256G)
Power(rated Power/standby power)	DC15V-24V (4/1.5W)
Operation	Touch button
Dimension	185*127*21.15mm
Features	
Lock control	Yes
Intercom transfer/ call/broadcast	Yes
DVR	Yes
Multimedia	Yes
Image capturing	Yes
Video/audio record	Yes
Calendar&alarm clock	Yes
Voice message	Yes
CCTV support	No
Wifi	No

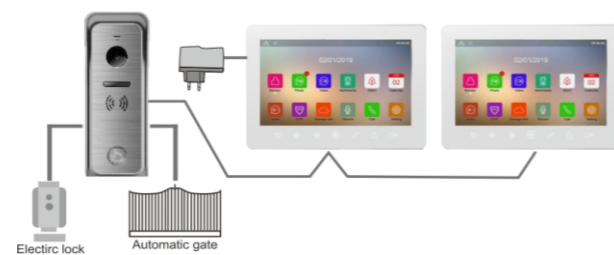

Model : 2M2307BKCO/2M2307BKCW

- 7 inch digital video door phone
- Premier design, friendly use by touch screen



Specification	2M2307BKCO	2M2307BKCW
Panel	7" digital TFT LCD	7" digital TFT LCD
TFT resolution	800*480	800*480
Connection/ Effective length	2-wire nonpolarity /100m	2-wire nonpolarity /100m
External memory card	Yes(8G-256G)	Yes(8G-256G)
Power(rated Power/standby power)	DC15V-24V (4/1.5W)	DC15V-24V (4/1.5W)
Operation	Touch screen	Touch screen
Dimension	185*127*21.15mm	185*127*21.15mm
Features		
Lock control	Yes	Yes
Intercom transfer/ call/broadcast	Yes	Yes
DVR	Yes	Yes
Multimedia	Yes	Yes
Image capturing	Yes	Yes
Video/audio record	Yes	Yes
Calendar&alarm clock	Yes	Yes
Voice message	Yes	Yes
CCTV support	No	No
Wifi	No	Yes



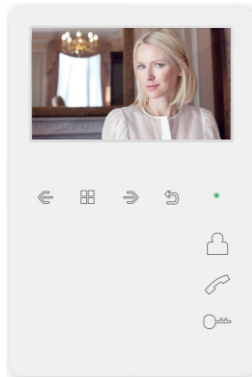

Model : 2M3604BKHO New

- 4.3 inch digital video door phone
- Premier design, friendly use by touch screen

Features:

- 2 WIRE
- DIGITAL SYSTEM
- H.264
- Camera icon
- Video call icon
- DVR
- Zoom icon

Specification	2M3604BKHO
Panel	4.3" digital TFT LCD
TFT resolution	480*272
Connection/ Effective length	2-wire nonpolarity /100m
External memory card	Yes(8G-256G)
Power(rated Power/standby power)	DC15V-24V (3W/1W)
Operation	Touch button
Dimension	180*118*22.5mm
Features	
Lock control	Yes
Intercom transfer/ call/broadcast	Yes
DVR	Yes
Multimedia	Yes
Image capturing	Yes
Video/audio record	Yes
Calendar&alarm clock	Yes
Voice message	Yes
CCTV support	No
Wifi	No

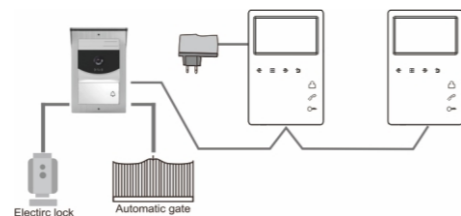

Model : 2M3200ANMO New

- Digital 2 wire, nonpolar and easy wiring

Specifications	2M3200ANMO
Connection/ Effective length	2-wire nonpolarity /100m
Power(rated Power/standby power)	DC 24V(1.5W/0.5W)
Operation	Mechanical buttons
Dimension	180*77*34mm
Features	
Lock control	Lock&Gate
Intercom to management Center	Yes
Ringtone adjustable	Yes
Ringvolume Adjustable	Yes





Model : 2D32BCBM01/02

- 2 locks control
- Night vision
- Water proof
- Support 1/2 subscribers



Model : 2D35BCBM01

New

- 2 locks control
- Night vision
- Water proof
- Support 1 subscriber

Specification	
Subscribers quantity	1/2
Camera image sensor	1/4" color CMOS
Viewing angle	110°
Resolution	1080P
Night vision	IR night LED
Installation method	Surface
Operating temperature	-25°C ~ +60°C
Connection	2 wire nonpolarity
Lock control	12-24V AC/DC 2A NO
Gate control	12-24V DC Max 150mA NO
Power	15-24V
Dimension	103*153.5*44.2mm
RFID unlocking	ID card

2D32BCBM01/02	
Subscribers quantity	1/2
Camera image sensor	1/4" color CMOS
Viewing angle	110°
Resolution	1080P
Night vision	IR night LED
Installation method	Surface
Operating temperature	-25°C ~ +60°C
Connection	2 wire nonpolarity
Lock control	12-24V AC/DC 2A NO
Gate control	12-24V DC Max 150mA NO
Power	15-24V
Dimension	103*153.5*44.2mm
RFID unlocking	ID card

Specification	
Subscribers quantity	1
Camera image sensor	1/4" color CMOS
Viewing angle	110°
Resolution	1080P
Night vision	IR night
Installation method	Surface
Operating temperature	-25°C ~ +60°C
Connection	2 wire nonpolarity
Lock control	NC DC12V 0.35MAX NO DC 12V 2A
Gate control	AC 125 1A DC DC30V 4A
Power	DC12V-24V 0.3A MAX
Dimension	152*55*21MM
RFID unlocking	ID card

2D35BCBM01	
Subscribers quantity	1
Camera image sensor	1/4" color CMOS
Viewing angle	110°
Resolution	1080P
Night vision	IR night
Installation method	Surface
Operating temperature	-25°C ~ +60°C
Connection	2 wire nonpolarity
Lock control	NC DC12V 0.35MAX NO DC 12V 2A
Gate control	AC 125 1A DC DC30V 4A
Power	DC12V-24V 0.3A MAX
Dimension	152*55*21MM
RFID unlocking	ID card





Model: 2D36ACBM01

- Aluminum front panel
- Lock control
- Night vision
- Water proof
- Support 1 subscriber



Model: 2D36BCM01

- Acrylic front panel
- Lock control
- Night vision
- Water proof
- Support 1 subscriber
- Support ID card

Specification	2D36ACBM01
Subscribers quantity	1
Camera image sensor	1/4" color CMOS
Viewing angle	110°
Resolution	1920x1080 (1080p)
Installation method	Surface mounted
Operating temperature	- 25°C to + 60°C
Connection	2-wire
Lock control	NC Lock of DC12V 0.35A (Max)
Lock control	NO Lock of DC12V ≤2A
Gate control	AC125V current ≤1A
Gate control	DC30V, current≤4A
Power	DC 12 - 24V
Dimension	142*56*34mm
Support lock type	DC5-24V electric lock
Gate control	DC12V 0.35A (Max)

Specification	2D36BCM01
Subscribers quantity	1
Camera image sensor	1/4" color CMOS
Viewing angle	110°
Resolution	1920x1080 (1080p)
Installation method	Surface mounted
Operating temperature	-25 °C to + 60°C
Connection	2-wire
Lock control	NC Lock of DC12V 0.35A (Max)
Lock control	NO Lock of DC12V ≤2A
Gate control	AC125V current ≤1A
Gate control	DC30V, current≤4A
Power	DC 12 - 24V
Dimension	142*56*34mm
Support lock type	DC5-24V electric lock
Gate control	DC12V 0.35A (Max)
RFID unlocking	ID card





Model: 2D37BCBM01/02
2D38BCBM01/02

New

- 2 locks control
- Night vision
- Water proof
- Support 1/2 subscribers



Model : 2D39BCBM01/02/04 **New**

- 2 locks control
- Night vision
- Water proof
- Support 1/2/4 subscribers

Specification	2D37BCBM01/02 2D38BCBM01/02
Subscribers quantity	1/2
Camera image sensor	1080P HD Camera
Viewing angle	110°
Resolution	1080P
Night vision	IR night LED
Installation method	Flush mounted
Operating temperature	-25°C~+60°C
Connection	2 wire nonpolarity
Lock control	NC 35mA(MAX) /NO 12V 2A
Gate control	AC 125V 0.25A / DC30V 1A
Power	18-30V
Dimension	212*105*38MM
RFID unlocking	ID card

Specification	2D39BCBM01/02/04
Subscribers quantity	1/2/4
Camera image sensor	1080P HD Camera
Viewing angle	110°
Resolution	1080P
Night vision	IR night LED
Installation method	Flush mounted
Operating temperature	-25°C ~ +60°C
Connection	2 wire nonpolarity
Lock control	NC 35mA(MAX) /NO 12V 2A
Gate control	AC 125V 0.25A / DC30V 1A
Power	18-30V
Dimension	241.05*139*45MM
RFID unlocking	ID card





Model : 2D40BCBM01/02/04 **New**

- Aluminum front panel
- Lock control
- Night vision
- Water proof
- Support 1/2/4 subscriber



Model : 2D42ACBM01
2D42BCBM02/04 **New**

- 2 locks control
- Night vision
- Water proof
- Support 1/2/4 subscribers

Specification	2D40BCBM01/02/04
Subscribers quantity	1/2/4
Camera image sensor	1080P HD Camera
Viewing angle	110°
Resolution	1080P
Night vision	IR night LED
Installation method	Surface mounted
Operating temperature	-25°C ~ +60°C
Connection	2 wire nonpolarity
Lock control	NC 35mA(MAX) /NO 12V 2A
Gate control	AC 125V 0.25A / DC30V 1A
Power	18-30V
Dimension	176.83*93.87*39.7MM
RFID unlocking	ID card

Specification	2D42ACBM01 / 2D42BCBM02/04
Subscribers quantity	1/2/4
Camera image sensor	1080P HD Camera
Viewing angle	110°
Resolution	1080P
Night vision	IR night LED
Installation method	Flush mounted
Operating temperature	-25°C ~ +60°C
Connection	2 wire nonpolarity
Lock control	NC 35mA(MAX) /NO 12V 2A
Gate control	AC 125V 0.25A / DC30V 1A
Power	18-30V
Dimension	Surface mounted(with rainhood) 200*95.6*39.2 MM
RFID unlocking	ID card (Only 2/4 buttons support)



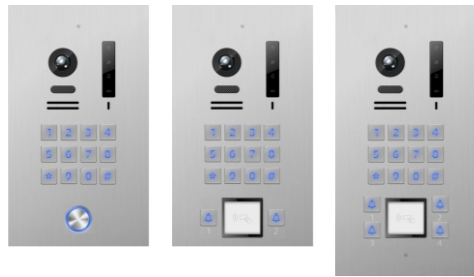

Model : 2D41ACBM01
2D41BCBM02/04

New

- 2 locks control
- Night vision
- Water proof
- Support 1/2/4 subscribers

Specification	2D41ACBM01 / 2D41BCBM02/04
Subscribers quantity	1/2/4
Camera image sensor	1080P HD Camera
Viewing angle	110°
Resolution	1080P
Night vision	IR night LED
Installation method	Flush mounted
Operating temperature	-25°C ~ +60°C
Connection	2 wire nonpolarity
Lock control	NC 35mA(MAX) /NO 12V 2A
Gate control	AC 125V 0.25A / DC30V 1A
Power	18-30V
Dimension	240*124.5*45MM
RFID unlocking	ID card (Only 2/4 buttons support)



2-Wire Apartment System



2D37BCBM05



2D37-EXT-M15



2D37BCBM20



2D37BCBT05



2D38BCBM00

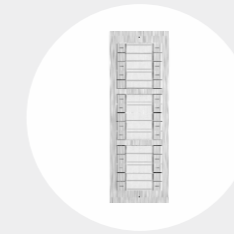

2D38-EXT-M30



2D38BCBM10



2D38BCBT10



2D37BCBM00



MO-KP-012

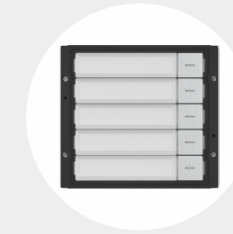

MO-B05-001/002

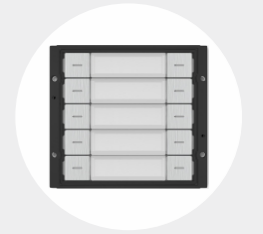

MO-B10-001/002



MO-DIS3-002



MO-CA-001



MO-KP-016



MO-NP-002



PW03A/B/C/D

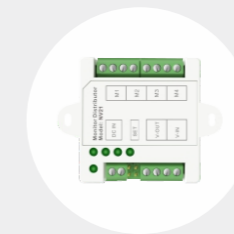

NV21



NH20

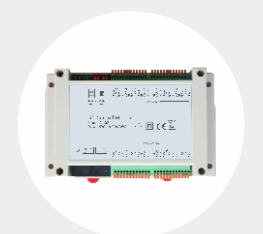

NL20



Model: 2D37BCBM20 / 2D38BCBM10 **New**

- Aluminum front panel
- Lock control
- Night vision
- Water proof

Specification	2D37BCBM20	2D38BCBM10
Subscribers quantity	20	10
Camera image sensor	1/4" color CMOS	1/4" color CMOS
Viewing angle	110°	110°
Resolution	1080P	1080P
Night vision	IR night	IR night
Installation method	Flush mounted	Surface mounted
Operating temperature	-25°C ~+60°C	-25°C ~+60°C
Connection	2-wire nonpolarity	2-wire nonpolarity
Lock control	12-24V AC/DC 2A NO	12-24V AC/DC 2A NO
Gate control	12-24V DC Max 150mA NO	12-24V DC Max 150mA NO
Power	15-24V	15-24V
Dimension	325*130*60mm	302*105*38mm



Model: 2D38BCBM05 **New**

- Aluminum front panel
- Lock control
- Night vision
- Water proof
- Support 5 subscribers

Specification	2D38BCBM05
Subscribers quantity	5
Camera image sensor	1/4" color CMOS
Viewing angle	110°
Resolution	1920x1080 (1080p)
Installation method	Surface mounted
Operating temperature	- 25 °C to + 60°C
Connection	2-wire
Lock control	NC Lock of DC12V 0.35A (Max) NO Lock of DC12V ≤2A
Gate control	AC125V current ≤1A DC30V, current≤4A
Power	DC 12 - 24V
Dimension	212*105*38MM





Model : 2D38BCBM00

New

- 2 locks control
- Night vision
- Water proof

Specification	2D38BCBM00
Subscribers quantity	72*8
Camera image sensor	1/4" color CMOS
Viewing angle	110°
Resolution	1080P
Night vision	IR night LED
Installation method	Surface
Operating temperature	-25°C ~+60°C
Connection	2-wire nonpolarity
Lock control	12-24V AC/DC 2A NO
Gate control	12-24V DC Max 150mA NO
Power	15-24V
Dimension	302*105*38mm
RFID unlocking	ID card



Model : 2D37BCBM00

New

- 2 locks control
- Night vision
- Water proof

Specification	2D37BCBM00
Subscribers quantity	72*8
Camera image sensor	1/4" color CMOS
Viewing angle	110°
Resolution	1080P
Night vision	IR night LED
Installation method	Flush mounted
Operating temperature	-25°C ~+60°C
Connection	2-wire nonpolarity
Lock control	12-24V AC/DC 2A NO
Gate control	12-24V DC Max 150mA NO
Power	15-24V
Dimension	325*130*60mm
RFID unlocking	ID card



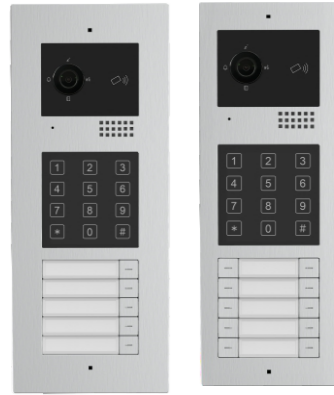

Model : 2D37BCBT05 / 2D38BCBT10

New

- 2 locks control
- Night vision
- Water proof

Specification	2D37BCBT05 / 2D38BCBT10
Subscribers quantity	5/10
Camera image sensor	1/4" color CMOS
Viewing angle	110°
Resolution	1080P
Night vision	IR night LED
Installation method	Surface/Flush mounted
Operating temperature	-25°C ~+60°C
Connection	2-wire nonpolarity
Lock control	12-24V AC/DC 2A NO
Gate control	12-24V DC Max 150mA NO
Power	15-24V
Dimension	325*130*60mm / 302*105*38mm
RFID unlocking	ID card

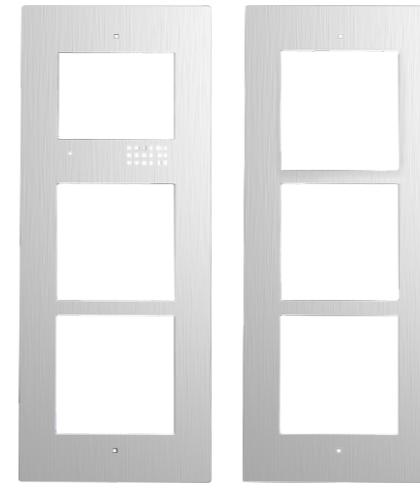

Model : 2D37-AC3-002/004

stainless steel frame for apartment outdoor station

- 2 locks control
- Night vision
- Water proof

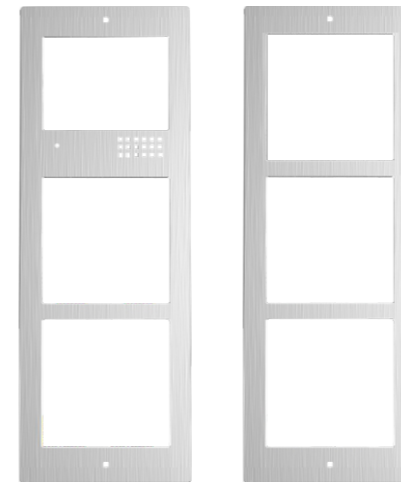

Model : 2D38-AC3-002/004

New

aluminium alloy frame outdoor station

- 2 locks control
- Night vision
- Water proof



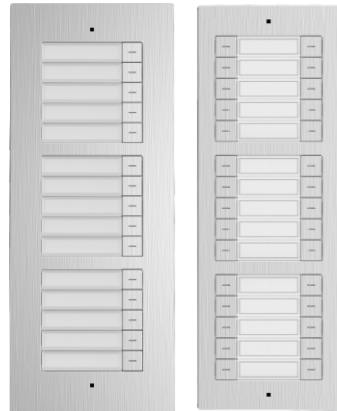

Model : 2D37-EXT-M15 /2D38-EXT-M30 New

- 2 locks control
- Night vision
- Water proof

Specification	2D37-EXT-M15	2D38-EXT-M30
Subscribers quantity	1-72	1-72
Camera image sensor	1/4" color CMOS	1/4" color CMOS
Viewing angle	110 °	110 °
Resolution	1080P	1080P
Night vision	IR night	IR night
Installation method	Flush mounted	Flush mounted
Operating temperature	-25°C ~ +60°C	-25°C ~ +60°C
Connection	2-wire nonpolarity	2-wire nonpolarity
Lock control	12-24V AC/DC 2A NO	12-24V AC/DC 2A NO
Gate control	12-24V DC Max 150mA NO	12-24V DC Max 150mA NO
Power	15-24V	15-24V
Dimension	325*130*60mm	302*105*38mm



Model : MO-CA-001 New
 ·Camera Module With ID Card Reader



Model : MO-KP-012/016 New
 ·Mechanical Keypad Module



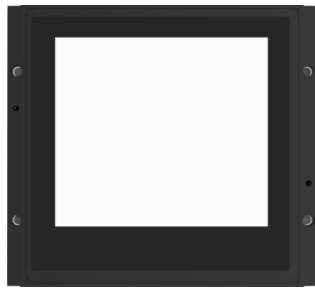

Model : MO-NP-002 **New**
·Blank Module Without Led Backlight



Model : MO-DIS3-002 **New**
·3.5" Display Module



Model : MO-B05-001/002 **New**
·Mechanical Button Module
Aluminum/Stainless Steel



Model : MO-B10-001/002 **New**
·Mechanical Button Module
Aluminum/Stainless Steel



Model : PW03A/B/C/D **New**

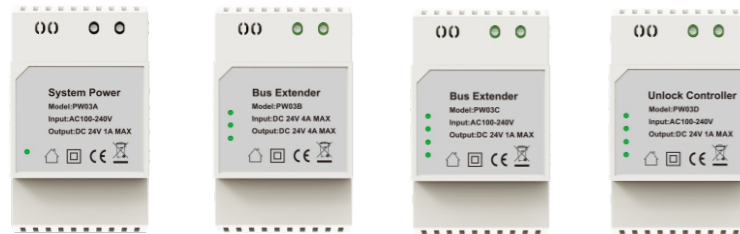

Specification	PW03A	PW03B	PW03C	PW03D
Subscribers quantity	4	NA	4	4
Installation method	Surface	Surface	Surface	Surface
Operating temperature	-25°C ~+45°C	-25°C ~+45°C	-25°C ~+45°C	-25°C ~+45°C
Connection	2-wire nonpolarity	2-wire nonpolarity	2-wire nonpolarity	2-wire nonpolarity
Input	AC100V-240V	DC18-30V 4A MAX	AC100V-240V	AC100V-240V
Output	DC24V 1A MAX	NA	DC24V 1A MAX	DC24V 1A MAX
Master BUS port quantity	NA	2	2	2
Slave BUS port quantity	NA	2	2	2
Unlock Power output	NA	NA	NA	DC12V 0.5A Max
Unlock output quantity	NA	NA	NA	1 Dry Contact
Dimension	90*53.5*58mm	90*53.5*58mm	90*53.5*58mm	90*53.5*58mm

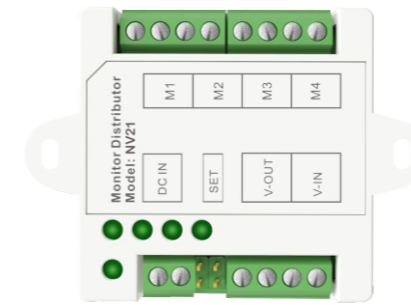

Model: NV21 **New**
Monitor Distributor

Specification	NV21
Subscribers quantity	4
Installation method	Surface
Operating temperature	-25°C ~+45°C
Connection	2-wire nonpolarity
Input	DC24V 4A MAX
Output	V-IN/V-OUT : DC24V 2.5A Max M1-M4 : DC24V 0.5A Max(M1-M3);1A Max(M4)
Dimension	62*45*27mm



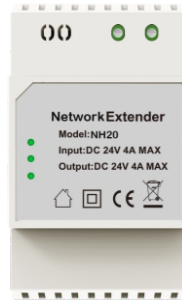

Model : NH20
Network Extender

New

Specification

Subscribers quantity
Installation method
Operating temperature
Connection
Input
2-wire main interface
2-wire branch interface
Network interface
Communication mode
2 Wire Bus Distance
Support Exchanger&Distance
Standby Power Consumption (No load)
Dimension

NH20

NA
Surface
-25°C ~+45°C
2-wire nonpolarity
DC24V 4A MAX
1 (input or output 3.5A Max)
1 (output 0.5A Max)
1 (can only be connected to a exchanger for now)
2-wire bus transmission
100M Point to Point (optimum Characteristic Impedance 100-120Ohm)
8 Port,100M between each 2 ports (Cat5 Cable)
≤0.8W
90*53.5*58mm

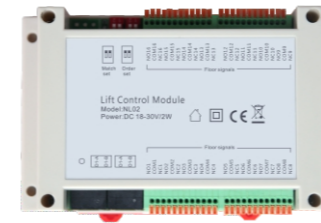

Model: NL02
Lift control module

New

Specification

Floors
Operation voltage
Operation Currency
Working temperature
Lift control signal
Operating temperature
Connection
Extended lift control module quantity
Communication mode
Communication signal isolation mode
Dimension

NL02

16
DC18V-30V
200mA(Max), 30mA(Standby)
-25°C to +45°C
16 channels relay output(NO/NC optional), no screw needed
- 25 °C to + 60°C
2-wire
4(Maximum support 64 floors)
2-wire BUS transmit
DIP switch
145*90*40mm



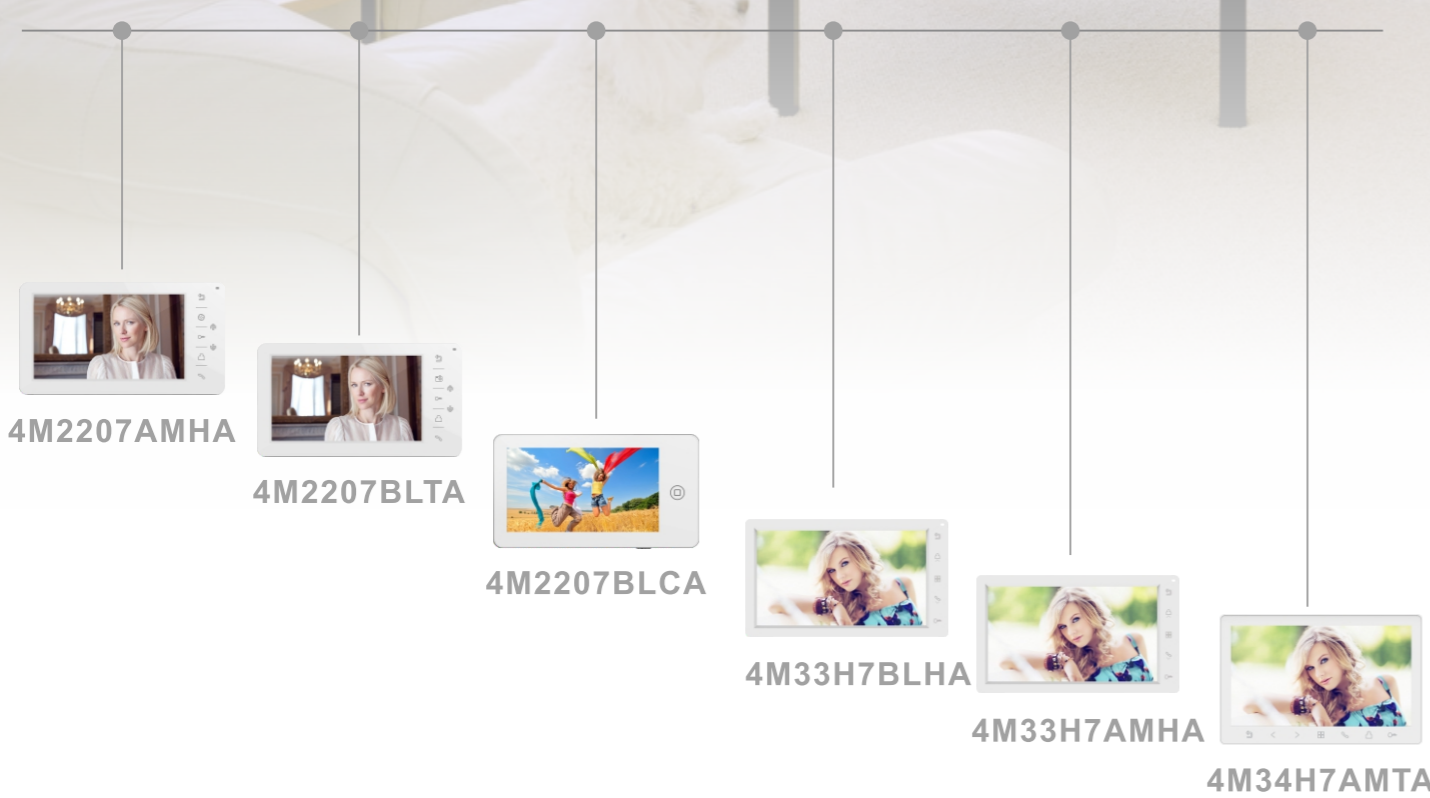

4-Wire AHD Villa System

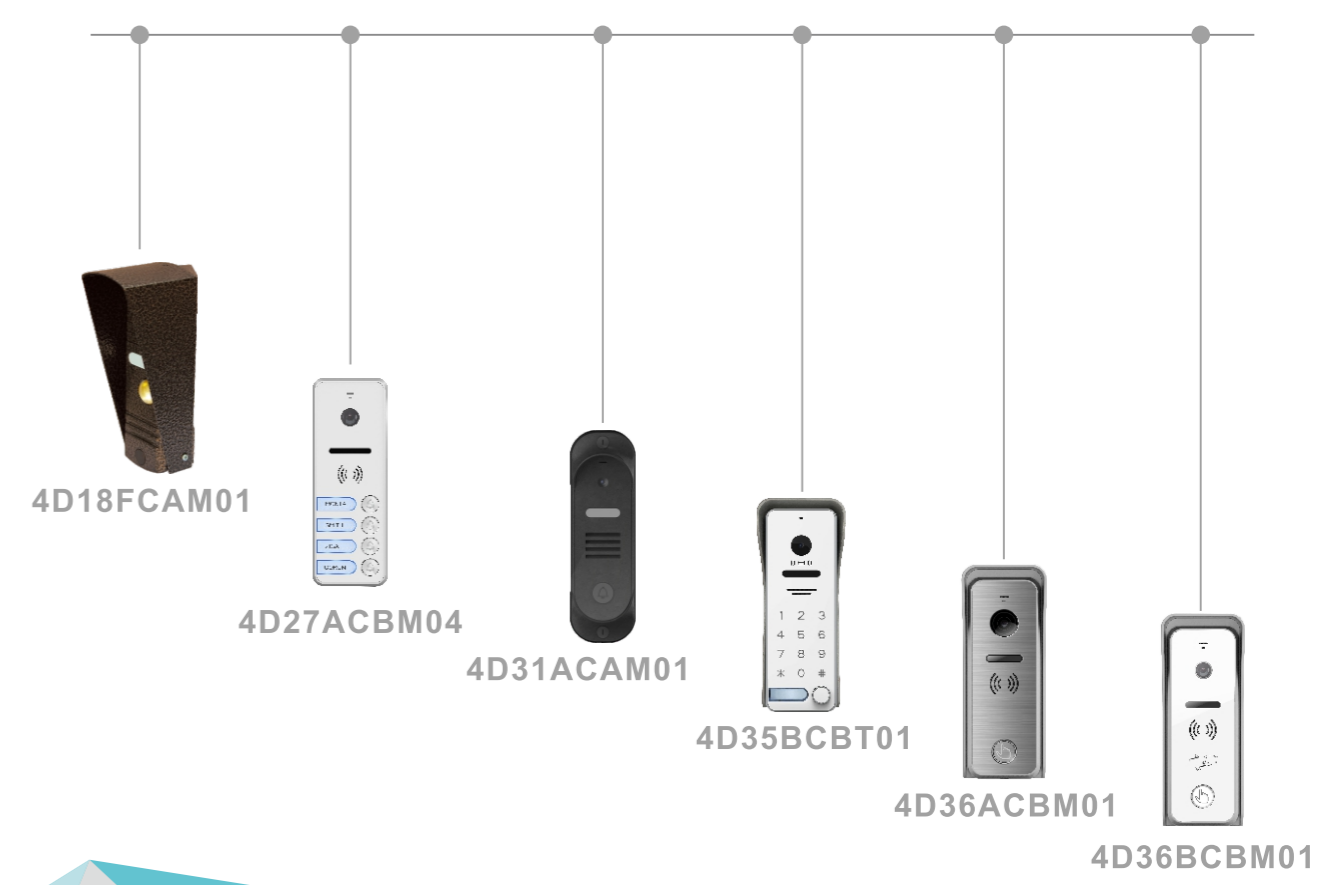
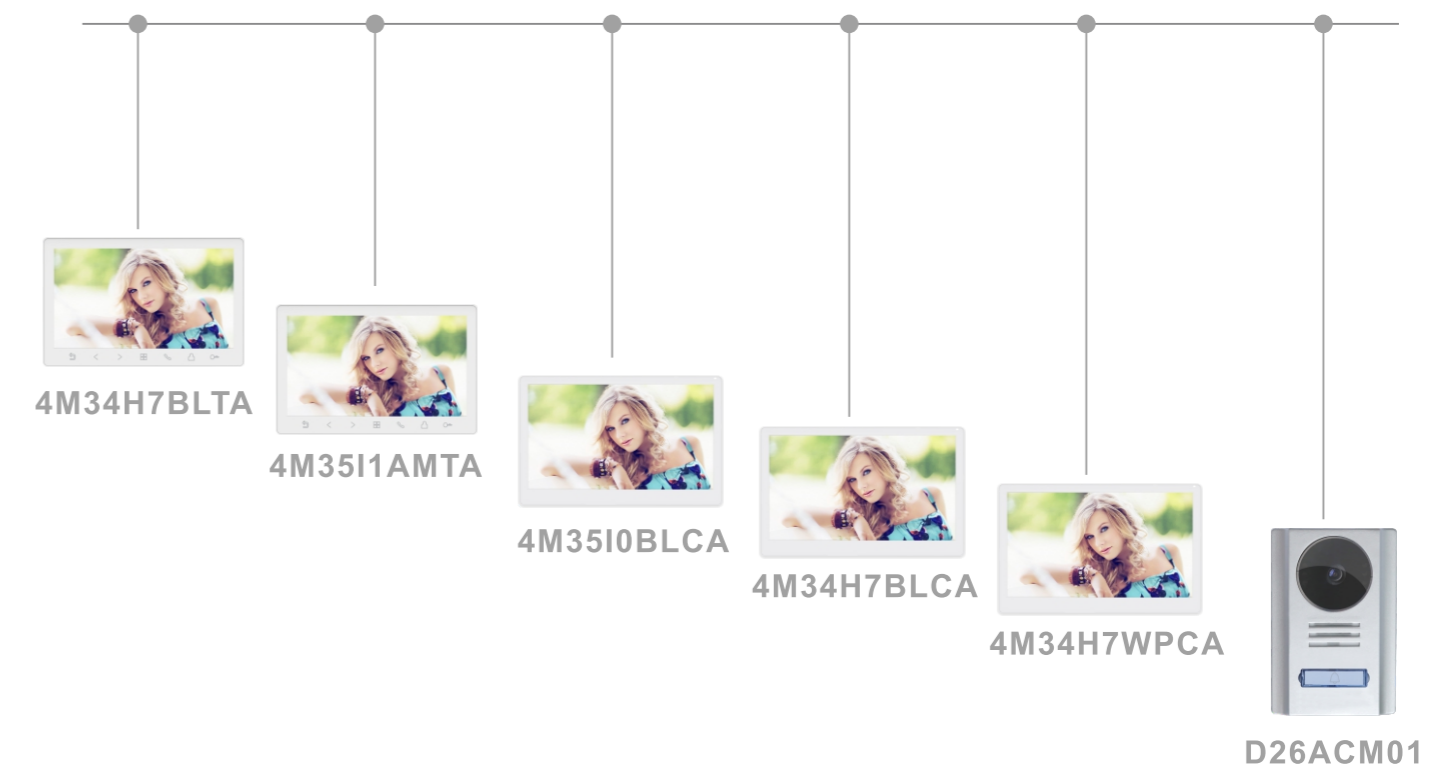

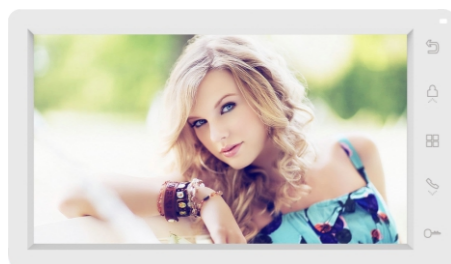

Model : 4M33H7BLHA / 4M33H7AMHA New

·7 inch digital video door phone
 ·Premier design, friendly use by touch button



Specification	4M33H7BLHA	4M33H7AMHA
Panel	7inch HD LCD	7inch HD LCD
TFT resolution	1024*600	1024*600
Connection/ Effective length	4wires /100m	4wires /100m
External memory card	Yes(8G-256G)	No
Power(rated Power/standby power)	DC 15V(5W/1.5W)	DC 15V(6W/0.5W)
Operation	Touch button	Touch button
Dimension	185. 5*108*19. 4mm	185. 5*108*19. 4mm
Features		
Lock control	Yes	Yes
Intercom transfer/ call/broadcast	Yes	Yes
DVR	Yes	No
Multimedia	Yes	No
Image capturing	Yes	No
Video/audio record	Yes	No
Calendar&alarm clock	Yes	No
Voice message	Yes	No
CCTV support	Yes	Yes

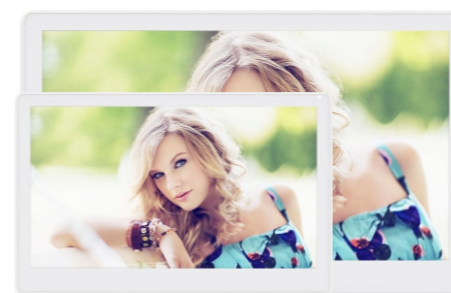

Model : 4M34H7WPCA / 4M35I1WPCA New

·7 inch digital video door phone
 ·Fashion design, friendly use by touch screen



Specification	4M34H7WPCA/4M35I1WPCA
Panel	7"HD / 10"HD IPS screen
TFT resolution	1024*600
Connection/ Effective length	4wires /100m
External memory card	Yes(8G-256G)
Power(rated Power/standby power)	DC15V (5W/1.5W)
Operation	Touch screen
Dimension	174.3*112*19.4mm / 244.7*156.1*19.7mm
Features	
Lock control	Yes
Intercom transfer/ call/broadcast	Yes
DVR	Yes
Multimedia	Yes
Image capturing	Yes
Video/audio record	Yes
Calendar&alarm clock	Yes
Voice message	Yes
CCTV support	Yes
Wifi	Yes

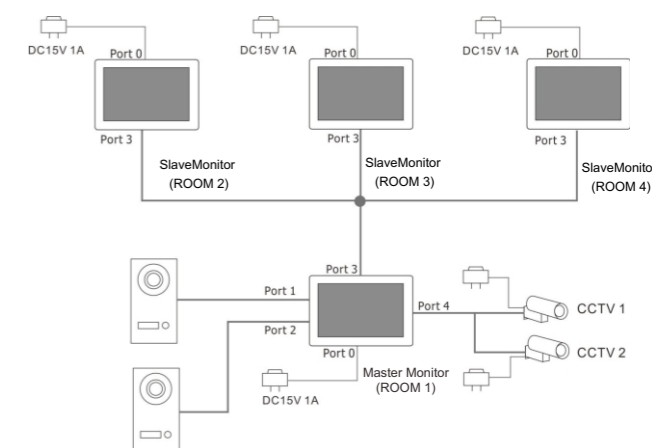
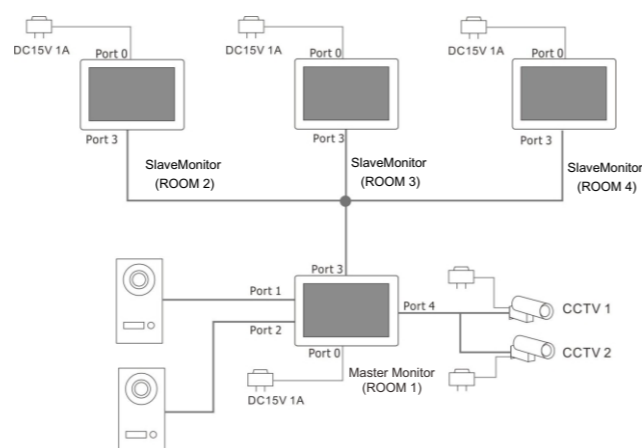

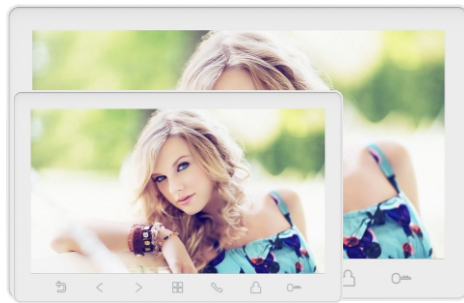

Model: 4M34H7AMTA/4M3511AMTA /
4M34H7BLTA

New

·7 inch /10 inch digital video door phone
·Fashion design, friendly use by touch button



Specifications	4M34H7AMTA	4M3511AMTA	4M34H7BLTA
Panel	7inch HD LCD	10inch HD LCD	7inch HD LCD
TFT resolution	1024*600	1024*600	1024*600
Connection/ Effective length	4wires /100m	4wires /100m	4wires /100m
Video channels quantity	2 door bells	2 door bells	2 door bells
Monitor quantity	4	4	4
External memory card	No	No	Yes(8G-256G)
Power(rated Power/standby power)	DC15V (6W/0.5W)	DC15V (6W/0.5W)	DC15V(5W/1.5W)
Operation	Touch button	Touch button	Touch button
Dimension	174.3*112*19.4mm	244.7*156.1*19.7m	174.3*112*19.4mm
Features			
Lock control	Yes	Yes	Yes
Intercom transfer/ call/broadcast	Yes	Yes	Yes
DVR	No	No	Yes
Multimedia	No	No	Yes
Image capturing	No	No	Yes
Video/audio record	No	No	Yes
Calendar&alarm clock	No	No	Yes
Voice message	No	No	Yes
CCTV support	Yes	Yes	Yes

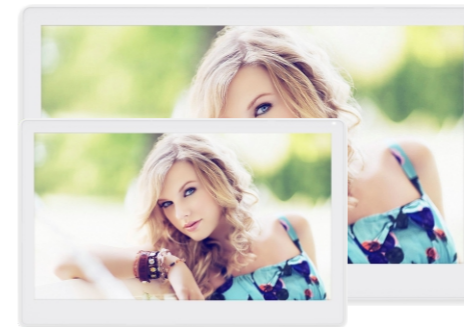
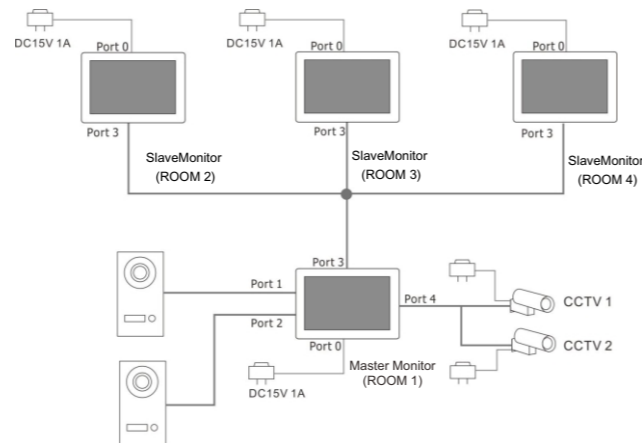

Model : 4M34H7BLCA / 4M3510BLCA
·7 inch/10 inch pad design video door phone
·Friendly use by touch screen

New



Specifications	4M34H7BLCA	4M3510BLCA
Panel	7"HD/IPS screen	10"HD/IPS screen
TFT resolution	1024*600	1024*600
Connection/ Effective length	4wires /100m	4wires /100m
Video channels quantity	2 door bells+2 CCTVs	2 door bells+2 CCTVs
Monitor quantity	4	4
External memory card	Yes(8G-256G)	Yes(8G-256G)
Power(rated Power/standby power)	DC15V (5W/1.5W)	DC15V (5W/1.5W)
Operation	Touch screen	Touch screen
Dimension	174.3*112*19.4mm	244.7*156.1*19.7mm
Features		
Lock control	Yes	Yes
Intercom transfer/ call/broadcast	Yes	Yes
DVR	Yes	Yes
Multimedia	Yes	Yes
Image capturing	Yes	Yes
Video/audio record	Yes	Yes
Calendar&alarm	Yes	Yes
Voice message	Yes	Yes

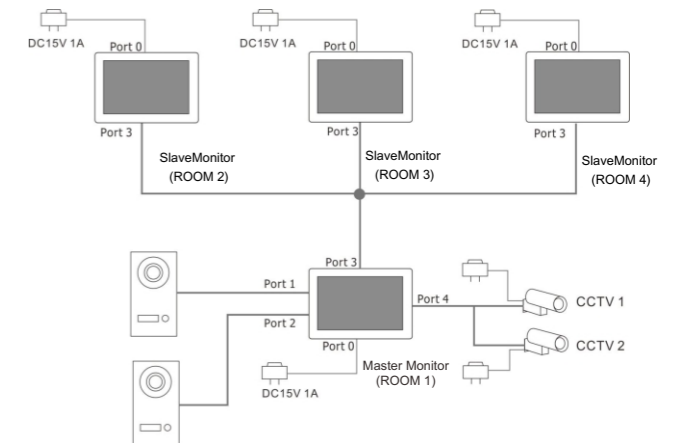

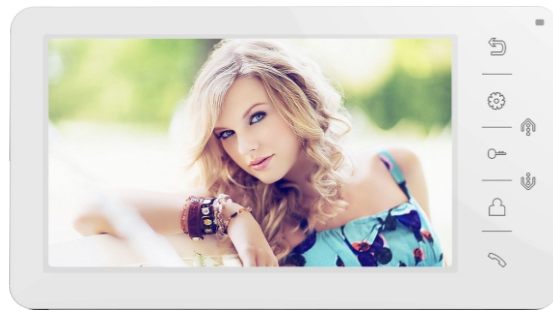

Model : 4M2207AMHA

- 7 inch digital video door phone
- Fashion design, friendly use by touch button

- Features:
- Image capture icon
 - Touch button icon
 - Wi-Fi icon
 - Phone icon
 - AHD icon

Specifications	4M2207AMHA
Panel	7" digital TFT LCD
TFT resolution	800*480
Connection/ Effective length	4wires /100m
Video channels quantity	2 door bells+2 CCTVs
Monitor quantity	4
External memory card	No
Power(rated Power/standby power)	DC15V (7W/1W)
Operation	Touch button
Dimension	210*116*25mm
Features	
Lock control	Yes
Voice monitoring	Yes
Intercom transfer/ call/broadcast	Yes
DVR	No
Multimedia	No
Image capturing	No
Video/audio record	No
Calendar&alarm clock	No
Voice message	No

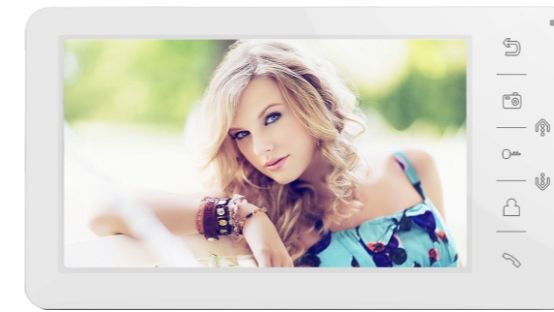

Model : 4M2207BLTA

- 7 inch digital video door phone
- Premier design, friendly use by touch button

- Features:
- Image capture icon
 - Calendar icon
 - Alarm clock icon
 - Wi-Fi icon
 - Touch button icon
 - Wi-Fi icon
 - Phone icon
 - DVR icon
 - Video camera icon
 - Image capture icon
 - Microphone icon
 - AHD icon

Specifications	4M2207BLTA
Panel	7" digital TFT LCD
TFT resolution	800*480
Connection/ Effective length	4wires /100m
Video channels quantity	2 door bells+2 CCTVs
Monitor quantity	4
External memory card	Yes(8G-256G)
Power(rated Power/standby power)	DC15V (7W/0.7W)
Operation	Touch button
Dimension	210*116*25mm
Features	
Lock control	Yes
Voice monitoring	Yes
Intercom transfer/ call/broadcast	Yes
DVR	Yes
Multimedia	Yes
Image capturing	Yes
Video/audio record	Yes
Calendar&alarm clock	Yes
Voice message	Yes

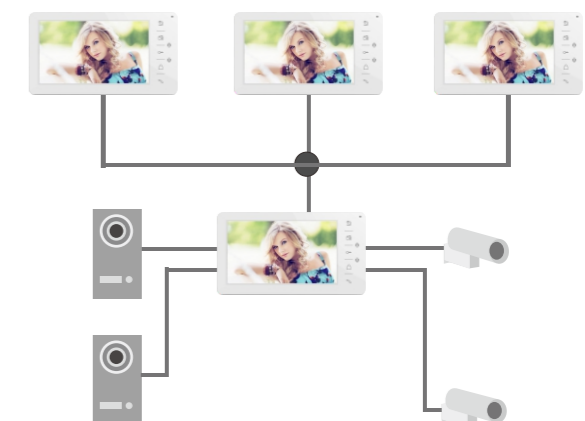
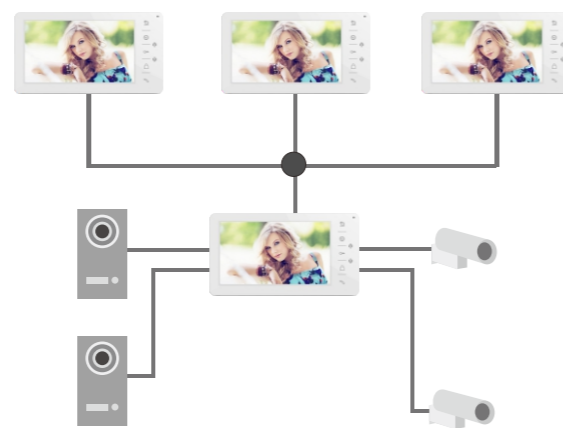



Model : 4M2207BLCA

- 7 inch digital video door phone
- Fashion design, friendly use by touch screen

Features:

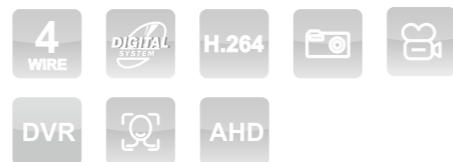

Specification	4M2207BLCA
Panel	7" digital TFT LCD
TFT resolution	800*480
Connection/ Effective length	4wires /100m
External memory card	Yes(8G-256G)
Power(rated Power/standby power)	DC 15V(5W/1.5W)
Operation	Touch screen
Dimension	208*143*22.5mm
Features	
App control	Yes
Lock control	Yes
Multimedia	Yes
Image capturing	Yes
Video/audio record	Yes
Calendar&alarm clock	Yes
Voice message	Yes
CCTV support	Yes and 2 Max.

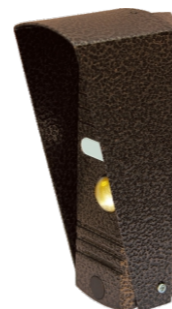
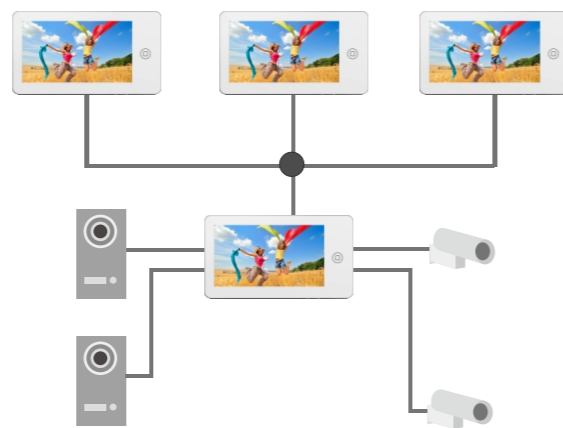

Model : 4D18FCAM01

- 2 locks control
- Night vision
- Water proof
- Support 1 subscriber

Specification	4D18FCAM01
Subscribers quantity	1
Camera image sensor	1/3" color CMOS
Viewing angle	70°
Camera Mode	1080P/720P/CVBS Optional
Installation method	Surface mounted
Operating temperature	-25 °C to +60 °C
Connection	4-wire or 5-wire
Lock control	Yes
Power	11 - 13V
Dimension	130*88*24mm





Model : D26ACM01

- 2 locks control
- Night vision
- Water proof
- Support 1 subscriber

Specification	D26ACM01
Subscribers quantity	1
Camera image sensor	1/2.9" color CMOS
Viewing angle	120°
Camera Mode	1080P/720P/CVBS Optional
Installation method	Surface mounted
Operating temperature	-25 °C to + 60°C
Connection	4-wire or 5-wire
Lock control	Yes
Power	11 - 13V
Dimension	130*88*24mm



Model : 4D27ACBM01/02/04

- Aluminum front panel
- 2 locks control
- Night vision
- Water proof
- Support 1/2/4 subscribers

Specification	4D27ACBM01/02/04
Subscribers quantity	1/2/4
Camera image sensor	1/2.9" color CMOS
Viewing angle	120°
Camera Mode	1080P/720P/CVBS Optional
Installation method	Surface mounted
Operating temperature	- 25 °C to + 60°C
Connection	4-wire
Power	DC11-14V
Dimension	144*55*21.45mm





Model : 4D31ACAM01

- Lock control
- Night vision
- Water proof
- Support 1 subscriber

Specification

Subscribers quantity
 Camera image sensor
 Viewing angle
 Camera Mode
 Installation method
 Operating temperature
 Connection
 Lock control
 Power
 Dimension
 Support lock type

4D31ACAM01

1
 1/3" color CMOS
 70°
 1080P/720P/CVBS Optional
 Surface mounted
 - 25 °C to + 60 °C
 4-wire
 Yes
 11 - 13V
 160*48*29mm
 DC5-24V electric lock



Model : 4D35BCBT01

- 2 locks control
- Night vision
- Water proof
- Support 1 subscriber

Specification

Subscribers quantity
 Camera image sensor
 Viewing angle
 Camera Mode
 Installation method
 Operating temperature
 Connection
 Lock control
 Working voltage
 Dimension
 RFID unlocking

4D35BCBT01

1
 1/2.9" color CMOS
 120°
 1080P/720P/CVBS Optional
 Surface mounted
 -25 °C to + 60 °C
 4-wire or 5-wire
 Yes
 DC 12V-15V
 130*88*24mm
 ID card





Model : 4D36BCBM01

- 2 locks control
- Night vision
- Water proof
- Support 1 subscriber

Specification	4D36BCBM01	4D36ACBM01
Subscribers quantity	1	1
Camera image sensor	1/2.9" color CMOS	1/2.9" color CMOS
Viewing angle	120°	120°
Camera Mode	1080P/720P/CVBS Optional	1080P/720P/CVBS Optional
Installation method	Surface mounted	Surface mounted
Operating temperature	-25 °C to + 60°C	-25 °C to + 60°C
Connection	4-wire or 5-wire	4-wire or 5-wire
Lock control	Yes	Yes
Power	11 - 13V	11 - 13V
Dimension	130*88*24mm	130*88*24mm
RFID unlocking	ID card	No
Support lock type	DC5-24V electric lock	DC5-24V electric lock



Model : 4D43ACBM01/4D43BCBM01

- Lock control
- Night vision
- Water proof
- Support 1 subscriber

specification	4D43ACBM01	4D43BCBM01
Subscribers quantity	1	1
Camera image sensor	1/2.9" color CMOS	1/2.9" color CMOS
Viewing angle	120°	120°
Camera Mode	1080P/720P/CVBS Optional	1080P/720P/CVBS Optional
Installation method	Surface mounted	Surface mounted
Operating temperature	- 25 °C to + 60°C	- 25 °C to + 60°C
Connection	4-wire	4-wire
Lock control	Yes	Yes
Power	DC 10 - 15V	DC 10 - 15V
Dimension	133.2*48*20mm	133.2*48*20mm
RFID unlocking	No	ID card



4-Wire CVBS Villa System

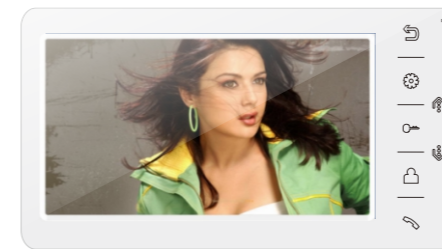

Model : M2207AIHA

·7 inch fashionable design

·Friendly use by touch button



Specifications

Panel
TFT resolution
Connection/ Effective length
Video channels quantity
Monitor quantity
External memory card
Power(rated Power/standby power)
Operation
Dimension

M2207AIHA

7" digital TFT LCD
800*480mm
4wires /100m
2 door bells+2 CCTVs
4
No
DC15V (7W/0.7W)
Touch button
210*116*25mm

Features

Lock control	Yes
Voice monitoring	Yes
Intercom transfer/ call/broadcast	Yes
DVR	No
Multimedia	No
Image capturing	No
Video/audio record	No
Calendar&alarm clock	No
Voice message	No

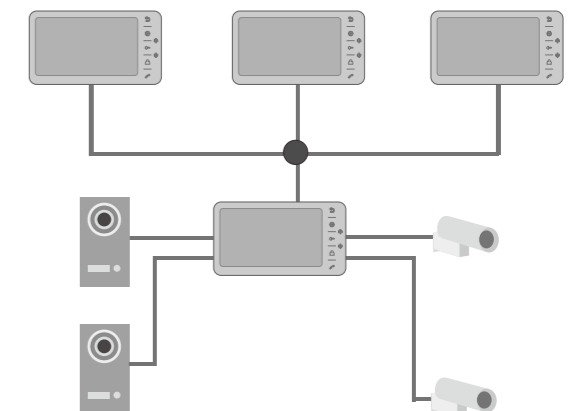

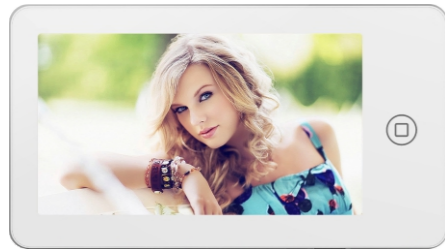

Model : M2207BFCA

- 7 inch pad design video door phone
- Friendly use by touch screen

Features:



Specifications	M2207BFCA
Panel	7" digital TFT LCD
TFT resolution	800*480
Connection/ Effective length	4wires /100m
Video channels quantity	2 door bells+2 CCTVs
Monitor quantity	4
External memory card	Yes(8G-256G)
Power(rated Power/standby power)	DC15V (9W/1.5W)
Operation	Touch screen
Dimension	210*116*25mm
Features	
Lock control	Yes
Voice monitoring	Yes
Intercom transfer/ call/broadcast	Yes
DVR	Yes
Multimedia	Yes
Image capturing	Yes
Video/audio record	Yes
Calendar&alarm	Yes
Voice message	Yes

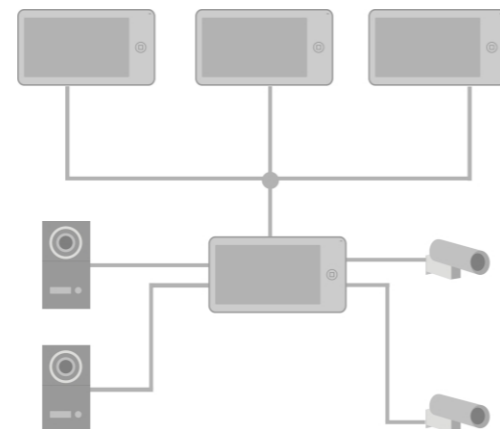

Model : M2604AIHA/M2804AIHA

- 4.3 inch simple and classic design
- Friendly use by touch button

Features:



Specifications	M2604AIHA	M2804AIHA
Panel	4.3" digital TFT LCD	4.3" digital TFT LCD
TFT resolution	480*272	480*272
Connection/ Effective length	4wires /100m	4wires /100m
Video channels quantity	2 door bells	2 door bells
Monitor quantity	4	4
Power(rated Power/standby power)	DC15V (5W/0.3W)	DC15V (5W/0.3W)
Operation	Touch button	Touch button
Dimension	180*112*17mm	180*112*17mm
Features		
Lock control	Yes	Yes
Voice monitoring	Yes	Yes
Intercom transfer/ call/broadcast	Yes	Yes
DVR	No	No
Multimedia	No	No
Image capturing	No	No
Video/audio record	No	No
Calendar&alarm clock	No	No
Voice message	No	No

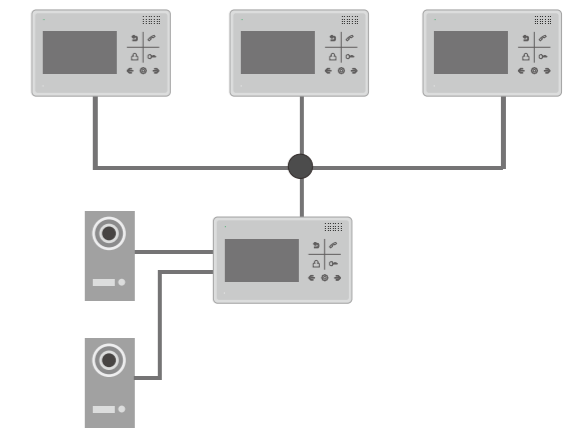



Model : M3004AIHA/M3004BFHA

- 4.3 inch classic design
- Friendly use by touch button
- Hand-free and Handset are optional



Specifications	M3004AIHA	M3004BFHA
Panel	4.3" digital TFT LCD	4.3" digital TFT LCD
TFT resolution	480*272	480*272
Connection/ Effective length	4wires /100m	4wires /100m
Video channels quantity	2 door bells	2 door bells
Monitor quantity	4	4
Power(rated Power/standby power)	DC15V (5W/0.3W)	DC15V (5W/0.3W)
Operation	Touch button	Touch button
Dimension	180*160*29mm	180*160*29mm
Features		
Lock control	Yes	Yes
Voice monitoring	Yes	Yes
Intercom transfer/ call/broadcast	Yes	Yes
DVR	No	Yes
Multimedia	No	Yes
Image capturing	No	Yes
Video/audio record	Yes	Yes
Calendar&alarm clock	No	Yes
Voice message	No	Yes

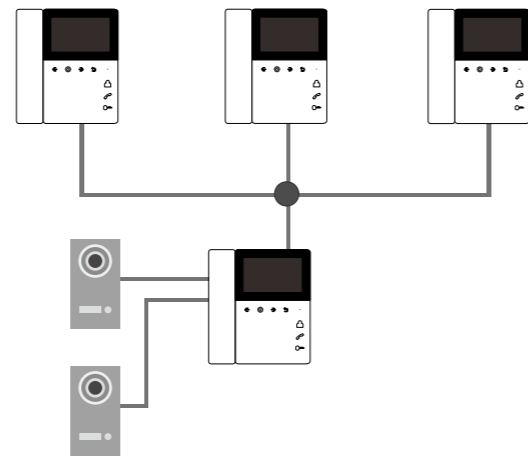

CAT-5 Apartment system

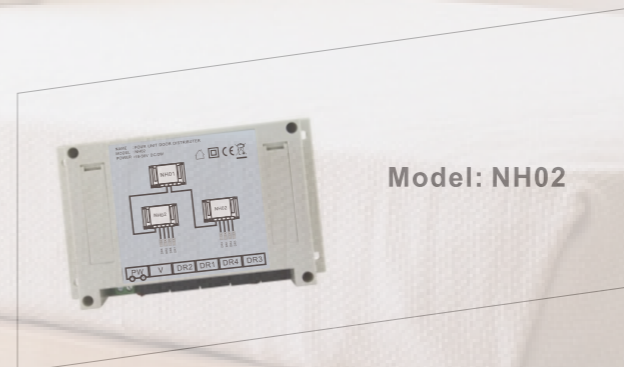
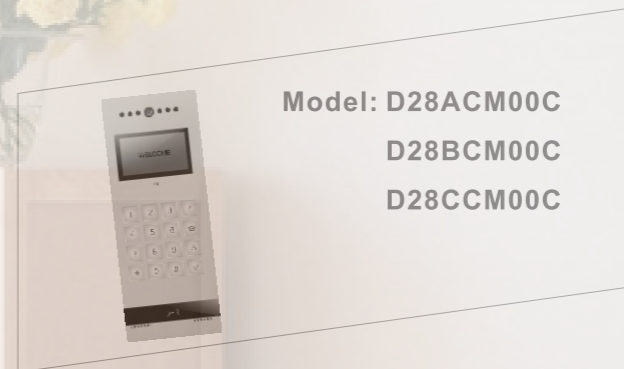

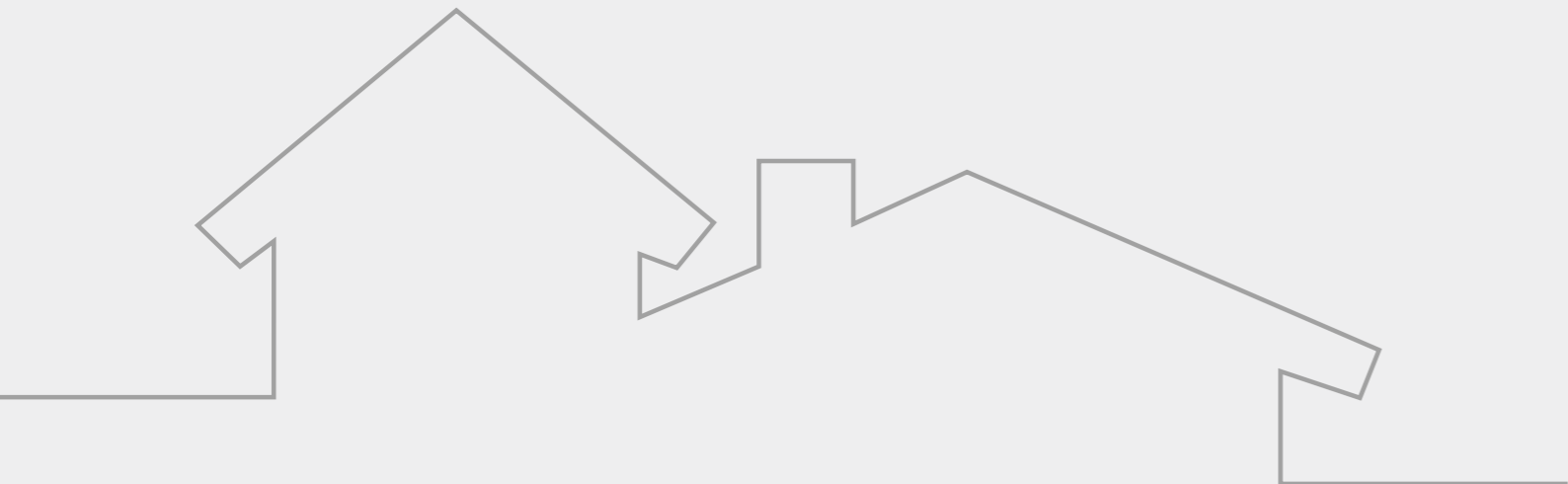

Model : D28ACM00C/BCM00C/CCM00C

- Lock control
- Night vision
- IC/ID card unlock
- HD COMS camera
- Support up to 9,999 subscribers

Specification	D28ACM00C	D28BCM00C	D28CCM00C
Subscribers quantity	up to 9,999 subscribers	up to 9,999 subscribers	Up to 9,999
Camera image sensor	1/4" CMOS	1/4" CMOS	1/4" CMOS
Installation method	Surface/flush mounted	Surface/flush mounted	Surface/flush mounted
Operating temperature	-25°C to +60°C	-25°C to +60°C	-25°C to +60°C
Connection	CAT-5	CAT-5	CAT-5
Lock control	Yes	Yes	Yes
Power(rated power/standby power)	18-36V(5W/1.5W)	18-36V(5W/1.5W)	18-36V(5W/1.5W)
LCD	STN 128*64	STN 128*64	STN 128*64
RFID unlocking	No	ID Card	IC Card
Dimension	370*140*28mm	370*140*28mm	370*140*28mm
Viewing angle	110°	110°	110°



Vertical Distributor

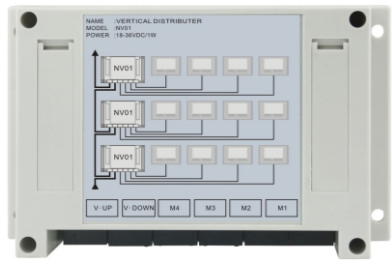

Model: NV01

- Install at floors
- Support 4 subscribers

Horizontal Networking Distributor

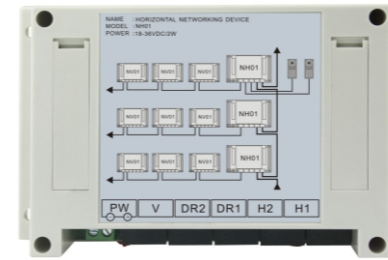

Model: NH01

- Connection between doorbell to system.
- Transfer signal to different apartment units.

Specifications

Power	18- 36V DC/ 0.8W(Standby)/2W(Normal)
Interface mode	RJ45 / CAT-5
Support indoor monitor quantity	4
Operating temperature	- 25°C to + 45°C
Communication mode	CAN Bus
Dimension	145*90*40mm
Installation method	Surface/Din-rail mounted

NV01

Power	18- 36V DC/ 0.8W(Standby)/2W(Normal)
Interface mode	RJ45 / CAT-5
Support indoor monitor quantity	4
Operating temperature	- 25°C to + 45°C
Communication mode	CAN Bus
Dimension	145*90*40mm
Installation method	Surface/Din-rail mounted

Specifications

Power	18- 36V DC/1W(Standby)/3W(Normal)
Interface mode	RJ45 / CAT-5
Support outdoor panel quantity	2
Horizontal networking distance(max)	1000m
Horizontal networking quantity(max)	99
Operating temperature	- 25°C to + 45°C
Communication mode	CAN Bus
Dimension	145*90*40mm
Installation method	Surface/Din-rail mounted

NH01

Power	18- 36V DC/1W(Standby)/3W(Normal)
Interface mode	RJ45 / CAT-5
Support outdoor panel quantity	2
Horizontal networking distance(max)	1000m
Horizontal networking quantity(max)	99
Operating temperature	- 25°C to + 45°C
Communication mode	CAN Bus
Dimension	145*90*40mm
Installation method	Surface/Din-rail mounted



Lift Control

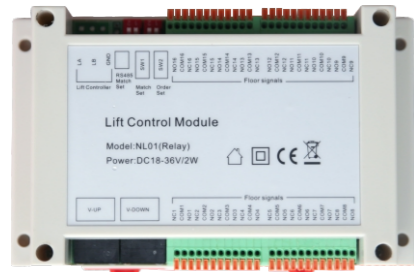

Model: NL01

- Relay output, support all kinds of lift control system.
- Can support 64 floors MAX

Specifications	NL01
Operation voltage	DC18V-36V
Operation Current	200mA(max), 30mA(standby)
Operation temperature	-25°C to +45°C
Operation humidity	0%~95%
Lift control signal	16 channels relay output(NO/NC optional), no screw needed
Extended lift control module quantity	4 (64 floors MAX)
Communication mode	CAN Bus
Communication signal isolation mode	Optoelectronic isolation
Dimension	145*90*40mm



Device for 4 Outdoor Stations Extension

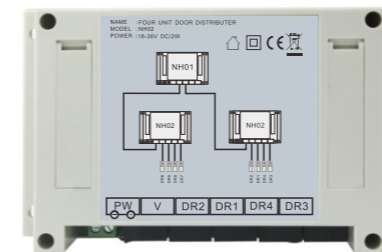

Model: NH02

- Using for extending 4 outdoor panels

Specifications	NH02
Power	18- 36V DC/1W(Standby)/3W(Normal)
Interface mode	RJ45 / CAT-5
Support outdoor panel quantity	4
Operating temperature	- 25 °C to + 45°C
Communication mode	CAN Bus
Dimension	145*90*40mm
Installation method	Surface/Din-rail mounted



System Power

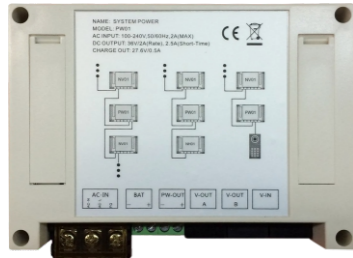

Model: PW01

- Supply power for apartment system.
- Backup power control.

Specifications	PW01
AC input	100- 240V, 50Hz/60Hz
DC output	36V/2.5A
Support indoor monitor quantity	36
Interface mode	RJ45 / CAT-5
Operating temperature	- 25°C to + 45°C
Battery charge out	27.6V/0.5A
Dimension	145*90*72mm
Installation method	Surface/Din-rail mounted
Optional	
Backup power	24V lead-acid battery

Signal converter



Model : NC01

- Supply power for indoor monitor
- Signal transfer between NV01 and indoor monitor

Specification	NC01
Power input	18- 36V DC / 0.5A
Power output	DC15V / 0.5A
Dimension	46*27*20mm



Video Signal Amplifier

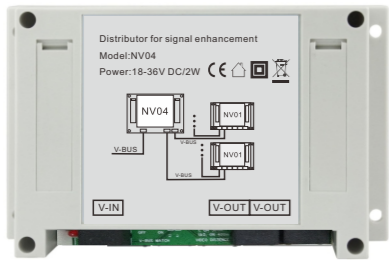

Model : NV04

- Vertical Bus Distributor
- Vertical Bus Video Amplifier

Specification

Specification	NV04
Power input	18- 36V DC / 0.2A
IO	Rj45
Distribution channel	2
Dimension	145*90*40mm



Apartment System Layout

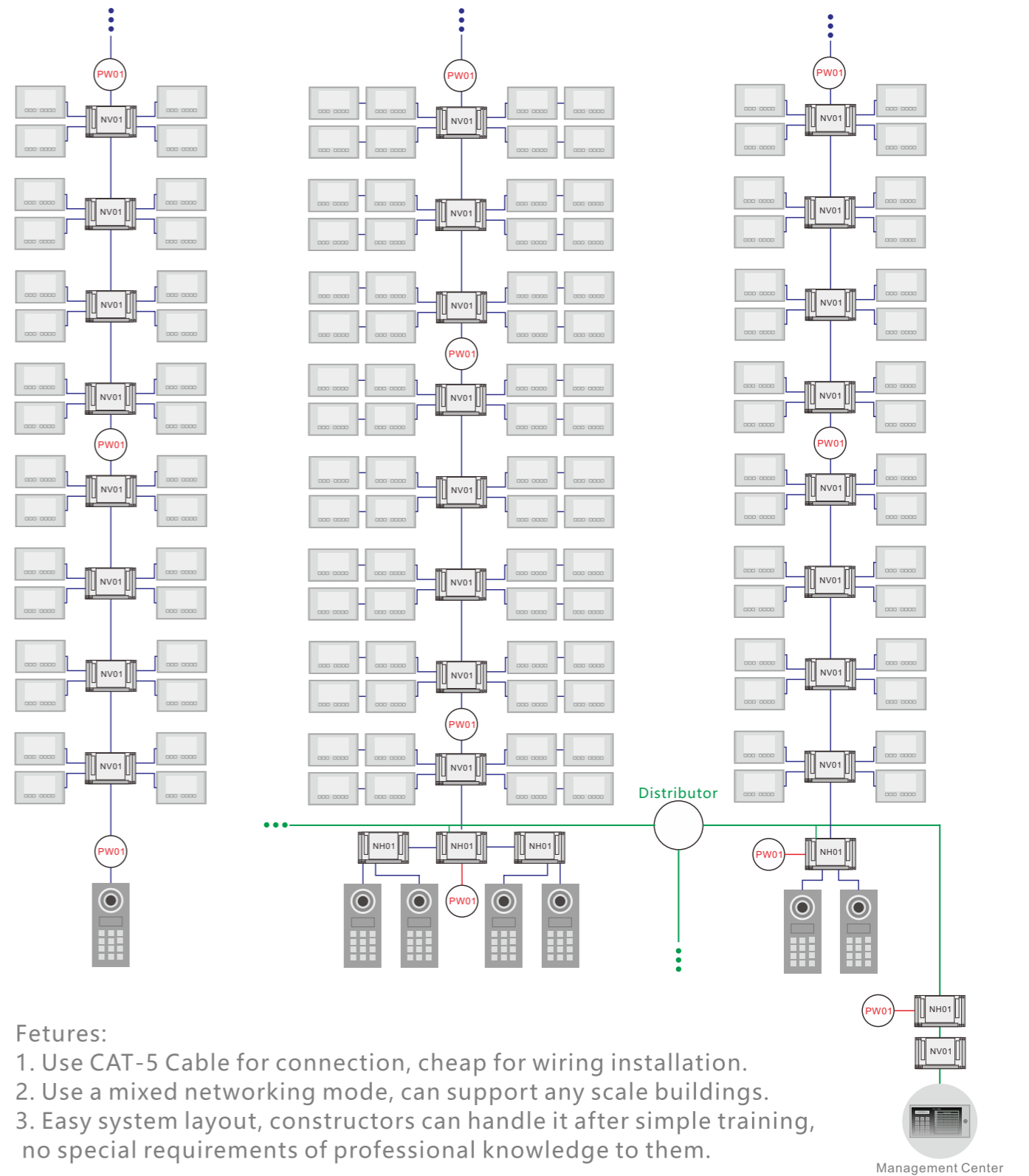

Features:

1. Use CAT-5 Cable for connection, cheap for wiring installation.
2. Use a mixed networking mode, can support any scale buildings.
3. Easy system layout, constructors can handle it after simple training, no special requirements of professional knowledge to them.