



GEKKO

FIRE ALARM CONTROL PANEL



MADE IN
PORTUGAL - EU

GLOBAL FIRE EQUIPMENT S.A.

Sítio dos Barrabés, Armazém Nave Y, Caixa Postal 908-Z, 8150-016 São Brás de Alportel - PORTUGAL • Tel: +351 289 896 560
Sales: sales@globalfire-equipment.com • Technical Support: techs@globalfire-equipment.com • www.globalfire-equipment.com



Installation & Commission Manual

INDEX

OVERVIEW	3
INTRODUCTION	3
KEY FEATURES	3
USER & INSTALLER ACCESS CODES	4
ACCESS LEVEL 1 - General User	4
ACCESS LEVEL 2 - Authorized User Controls	4
ACCESS LEVEL 3 - Authorized Installer Controls (Programming Mode)	4
TYPICAL WIRING SCHEMATIC	5
PRIMARY SUPPLY REQUIREMENTS	6
BATTERY REQUIREMENTS	7
ABS BOX INFORMATION	8

IDENTIFYING COMPONENTS	9
GEKKO MAIN BOARD	9
COMMUNICATION INTERFACES	10
EN54 INFORMATION	11
SYSTEM LIMITATIONS	11
TERMS, DEFINITIONS AND ABBREVIATIONS	12
INSTALLATION	13
INTRODUCTION	13
CONTROL PANEL	13
Mains Power connection	13
Other Panel connections	13
REPEATERS	13
PANEL CONNECTIONS	13
GEKKO Main Board	14
GEKKO Loop Card fitting	15
COMMUNICATION CHANNELS	16
Extra Display	16
Network Repeaters	16
ANALOGUE LOOP(S)	17
CONVENTIONAL SOUNDERS	18
AUXILIARY FIRE RELAYS (2) AND FAULT RELAY (1)	18
PANEL BATTERIES	19
RECOMMENDED CABLES	20
COMMISSIONING	21
INTRODUCTION	21
THE PANEL BUTTONS	21
CONTROLS	22
DISABLEMENTS	22
QUEUE REVIEW	22
GETTING THE PANEL RUNNING	23
GETTING AN EXTERNAL CHAMELEON DISPLAY RUNNING	23
GETTING A CHAMELEON REPEATER PANEL RUNNING	24
GETTING INTO PROGRAMMING MODE (ACCESS LEVEL 3)	24
GETTING THE SYSTEM RUNNING	25
WRAPPING UP INSTALLATION AND COMMISSIONING	27
PROGRAMMING FUNCTIONS	28
COMPLETE LIST OF FUNCTIONS	28
PROGRAMING FUNCTIONS DESCRIPTION	30
TECHNICAL SPECIFICATIONS	43
EN54-13 SPECIFICATIONS	45
DECLARATION OF CE CONFORMITY	49

OVERVIEW

INTRODUCTION

This document covers the installation and commissioning of a GEKKO fire alarm panel. This document is intended for use by a competent, qualified, fire alarm installation engineer.

The GEKKO fire alarm system should be tailored to the building requirements. The complete system should be designed to meet all applicable regulations. The installation must then be performed in accordance with the system design. This manual not only clarifies the components and connections during installation, but will also assist in commissioning and maintenance.

This manual covers the installation and commissioning of a complete system, excluding the communications system. Please refer to Chameleon Communications Manual.



**ELECTRO-STATIC SENSITIVE DEVICES (ESD)
TAKE SUITABLE ESD PRECAUTIONS WHEN REMOVING OR
INSTALLING PRINTED CIRCUIT BOARDS.**

All PCBs contain Electrostatic Sensitive Devices.

Take suitable ESD (Electrostatic Discharge) precautions when removing or installing printed circuit boards (PCBs).

KEY FEATURES

- **1 to 4 loops panel**
- **Supports connection to Repeaters via RS422, Fibre-Optic or TCP/IP**
- **Networkable panel, compatible with OCTO+ and NODE+ range of panels**
- **Up to 250 devices per loop (only 125 addresses available)**
- **Up to 95 VULCAN 2 (addressable) ultra low current base sounders (32 address limit)**
- **32 individually programmable sounder addresses**
- **Full Self-Addressable Devices support**
- **2 Fire output relays (change-over) and 1 Fault relay (NC - opens on fault)**
- **2 conventional alarm outputs (Individually programmable)**
- **Both detection loops monitored for integrity**
- **384 fully programmable zones**
- **512 fully programmable sounder groups**
- **512 I/O groups**
- **Event log (rolling, 10000 entries)**
- **Available only with ZEOS protocol**
- **Compatible with all our own low cost ancillary modules**
- **Backlit graphical LCD display of 240x64 pixels**
- **Programming by integrated keypad or Loader PC software**
- **Multiple language support (menu selectable)**
- **Integrated 16 zone LED fire zone indication.**

USER & INSTALLER ACCESS CODES

ENTER Used to confirm entry of any data or selection.

▲ Used to increase selection or number. Also used for code entry.

▼ Used to decrease selection or number. Also used for code entry.

▶ Used to change display cursor, when required.

ESC Escape key. Used to exit a particular function.

▶ ▲ ▼ To access codes use the arrow keys and when finished press ENTER.

NOTE: *It is not possible to introduce text for labels using the front panel keypad. For text update the “Chameleon Connector Software” should be used.*

ACCESS LEVEL 1 - General User

Unless otherwise indicated, in order to enable the operation of a particular switch, either a valid User or Programming Access Code is required to be entered.

The only exceptions are the following:

- 1 - Lamp Test Switch
- 2 - Queue Review Switches (Fire, Fault, Test and Disabled)

ACCESS LEVEL 2 - Authorized User Controls

Access to this level is accomplished by the introduction of a code using the panel's keypad.

The user code is factory set to ▲▲▲▲▲ and after entering each digit, press OK to confirm entry.

INTERNAL BUZZER SILENCE

The occurrence of any new fire or fault condition will initiate the operation of the internal buzzer. By pressing this switch, the operation of the buzzer will be stopped until a new fire or fault appears on the system.

ALARM SILENCE/RESOUND

Activates all sounders. A second press deactivates all sounders.

The button LED (Red) is ON whilst the sounders are activated.

SOUNDERS ENABLE/DISABLE

Pressing this button will enable/disable all sounders, both conventional sounder circuits and addressable sounders.

DELAYS ACTIVE

Pressing this button will activate any preprogrammed delays. The Yellow LED associated with this button and the general disablements LED will both be lit. A second press of this button will deactivate the delays and the LED. Under any fire condition the delays will be activated. If during the course of these delays, at access level 1 (General User - code entry not required), this button is pressed, the delays will be overridden and the sounders together with any other fire indicating equipment will be activated.

ACCESS LEVEL 3 - Authorized Installer Controls (Programming Mode)

Access to this level is accomplished by the introduction of a code using the panel's keypad.

Press ENTER, then Installer Access Code ▲▼▲▼▲ and then press ENTER to confirm entry.

Please go to chapter “[GETTING INTO PROGRAMMING MODE \(ACCESS LEVEL 3\)](#)” for further information.

TYPICAL WIRING SCHEMATIC

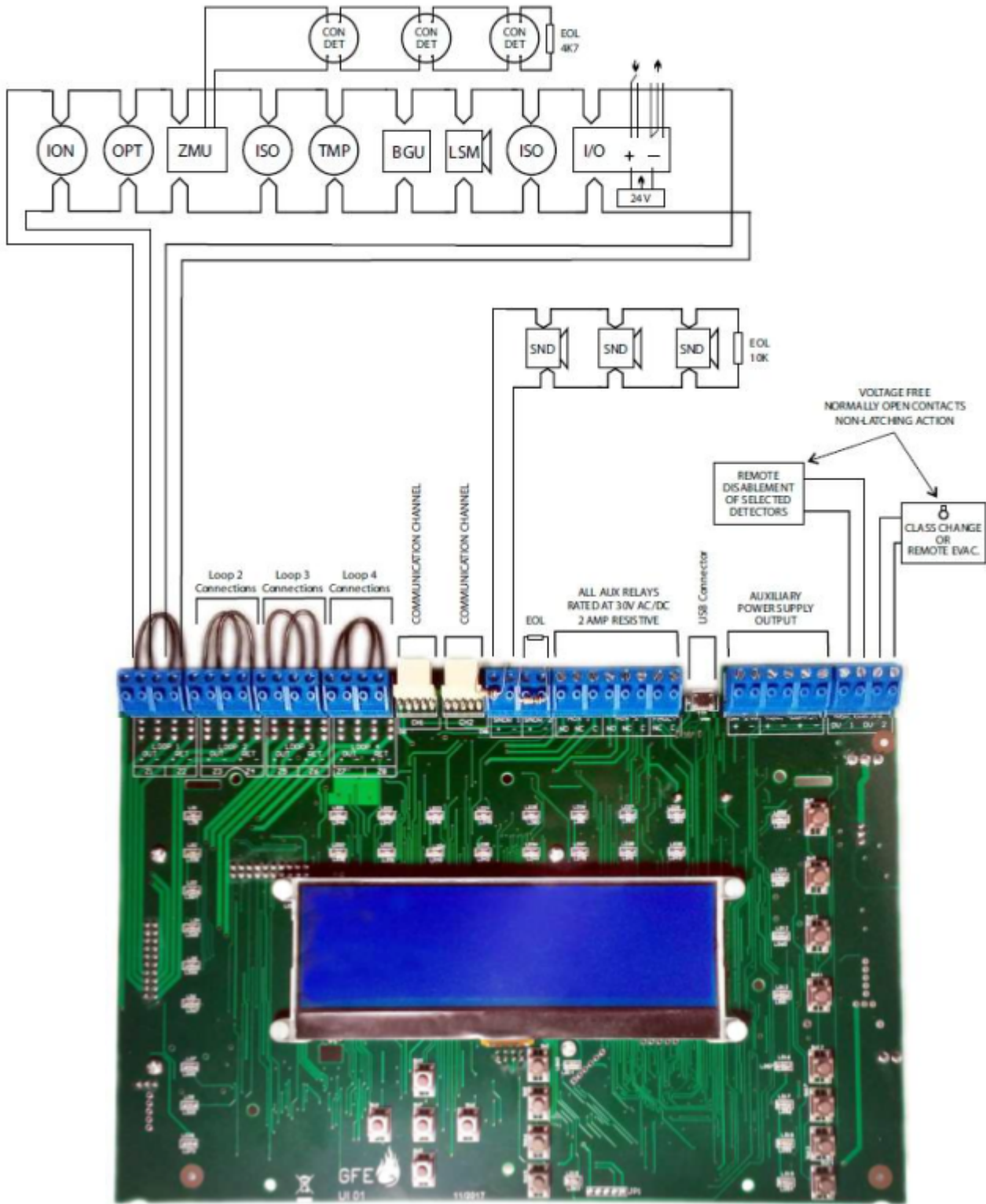

PRIMARY SUPPLY REQUIREMENTS

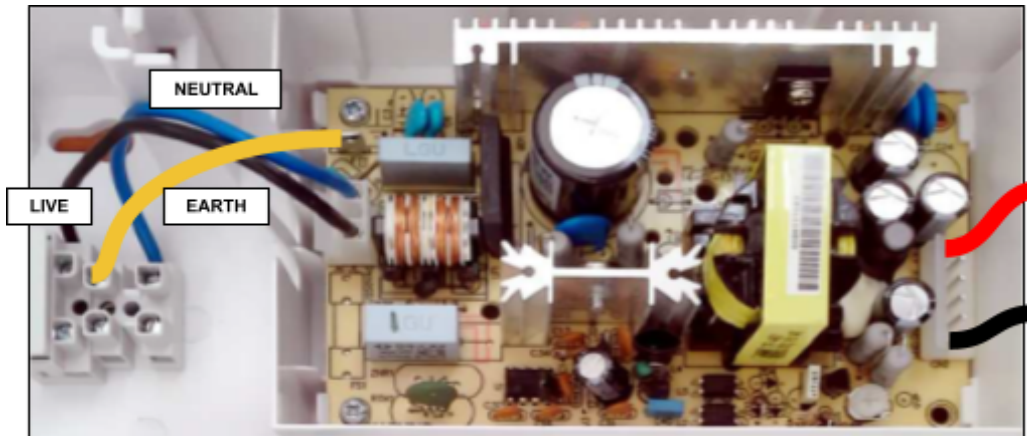

MODEL: PS-65-28.5

DANGER
220 VOLTS

POWER SUPPLY SPECIFICATION - MEANWELL Model: PS-65-28.5

MAINS SUPPLY VOLTAGE	85-264 V 50/60 Hz
INTERNAL POWER SUPPLY	Min. 20V DC - Max. 30V DC (28.5V DC nominal) Max. Ripple 1 V peak-peak
TOTAL OUTPUT CURRENT	2,4 A @ 230 Vac
SUPPLY AND BATTERY CHARGER MONITORED	YES
BATTERIES MONITORED	YES
MAX BATTERY SIZE	2 x 12 V 7 AH VRLA
MAINS FUSE	4 A - 250 V Slow Blow - 20 mm
BATTERY FUSE	1.8 A Resettable - Electronic Fuse
MAX CURRENT DRAW FROM BATTERY (MAINS FAIL)	1,8 A Max. @ Max. Operating Temperature

Voltage

Primary supply voltage	85 - 264V A.C.
EMC Standard	EN55022 class B EN61000-4-2,3,4,5,6,8,11 EN61000-3-2,3

Current

2.4 A PSU's recommended for 1 to 4 loop panels.

The maximum alarm sounder current is 250 mA for each conventional sounder circuit.
The maximum quiescent current per loop is 165 mA.
The loop short circuit (trip) current is 900 mA.

Battery

Internal maximum 24 V / 7 AH
Deep box version 24V / 12 AH

BATTERY REQUIREMENTS

The battery AH required are calculated from the following formula:

$$\left(\begin{array}{l} \text{Quiescent current in mA of the} \\ \text{panel with everything connected} \end{array} \times \begin{array}{l} \text{Standby time required in} \\ \text{hours divided by 1000} \end{array} \right) + \left(\begin{array}{l} \text{Alarm current in Amps} \\ \text{(sounder load)} \end{array} \times \begin{array}{l} \text{Alarm time in hours} \end{array} \right) + 20\%$$

Round up to the next available battery size.

Quiescent currents for individual equipments are listed below:

EQUIPMENT	QUIESCENT CURRENT (mA)	ALARM CURRENT (mA)
GEKKO Panel	52	91
24V auxiliary outputs (2 OFF)	Refer to connected devices	-

NOTE: In 2 to 4 loop panels use 7 AH batteries.

Example: A given installation has a single loop panel with 58 mA detector load, 1.4 A sounder load (including loop sounders) and a 24 hour standby requirement.

$$\left(\begin{array}{l} \text{Quiescent current in mA} \\ \text{of the panel with} \\ \text{everything connected} \end{array} \times \begin{array}{l} \text{Standby time} \\ \text{required in hours} \\ \text{divided by 1000} \end{array} \right) + \left(\begin{array}{l} \text{Alarm current} \\ \text{in Amps} \\ \text{(sounder load)} \end{array} \times \begin{array}{l} \text{Alarm time} \\ \text{in hours} \end{array} \right) + 20\%$$

$$\left(\begin{array}{l} 52 \text{ (GEKKO)} \\ + \\ 58 \text{ (detector load)} \\ \hline 110 \text{ mA} \end{array} \times \begin{array}{l} 24 \\ \text{(standby in hrs)} \\ \text{divided by 1000} \\ \hline 0,024 \text{ h} \end{array} \right) + \left(\begin{array}{l} 91 \text{ (GEKKO)} \\ + \\ 58 \text{ (detector load)} \\ \hline 149 \text{ mA} \\ + \\ 1.4 \text{ A} \\ \text{(sounder load)} \\ \hline 1,549 \text{ A} \end{array} \times \begin{array}{l} 0.5 \\ \text{(alarm time} \\ \text{in hrs)} \\ \hline 0,5 \text{ h} \end{array} \right) + 20\%$$

$$\left(110 \text{ mA} \times 0,024 \text{ h} \right) + \left(1,549 \text{ A} \times 0,5 \text{ h} \right) + 20\%$$

$$2,64 \text{ Ah} + 0,774 \text{ Ah} + 20\%$$

= 3,414 AH +20% (0,722 AH) = 4,096 Ah
The next available battery size is 5 Ah. Use 7 Ah

ABS BOX INFORMATION

Standard box

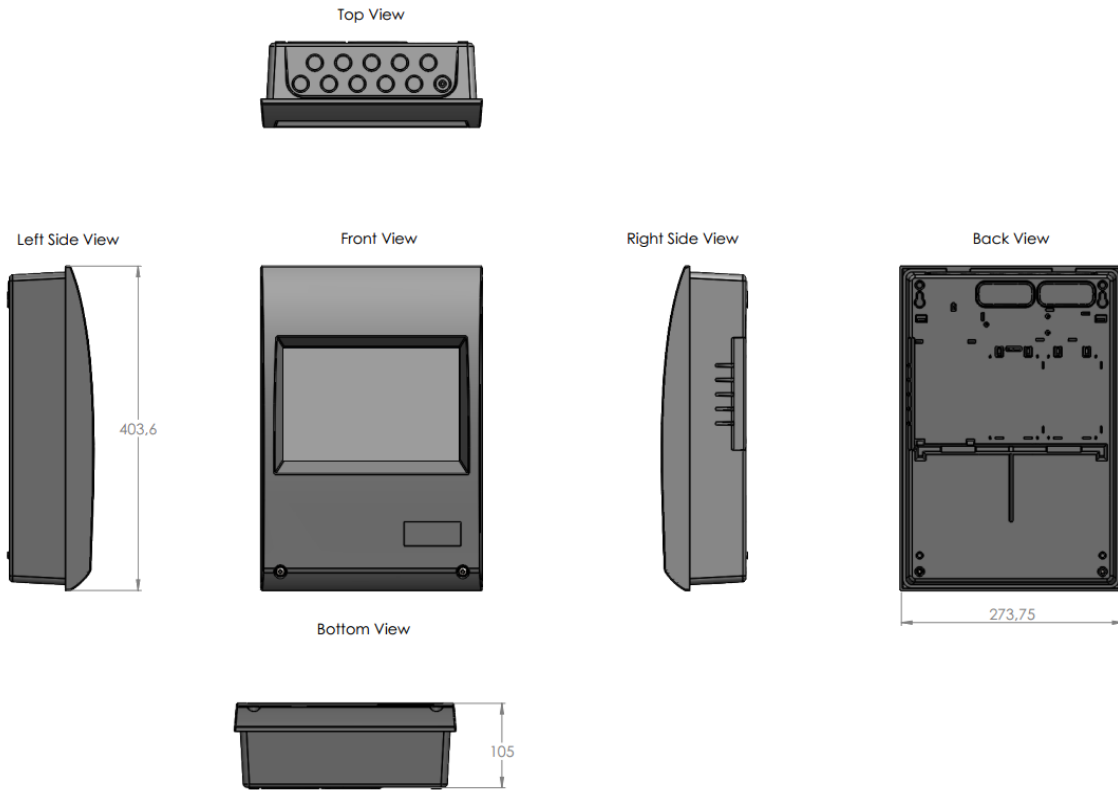

Large box

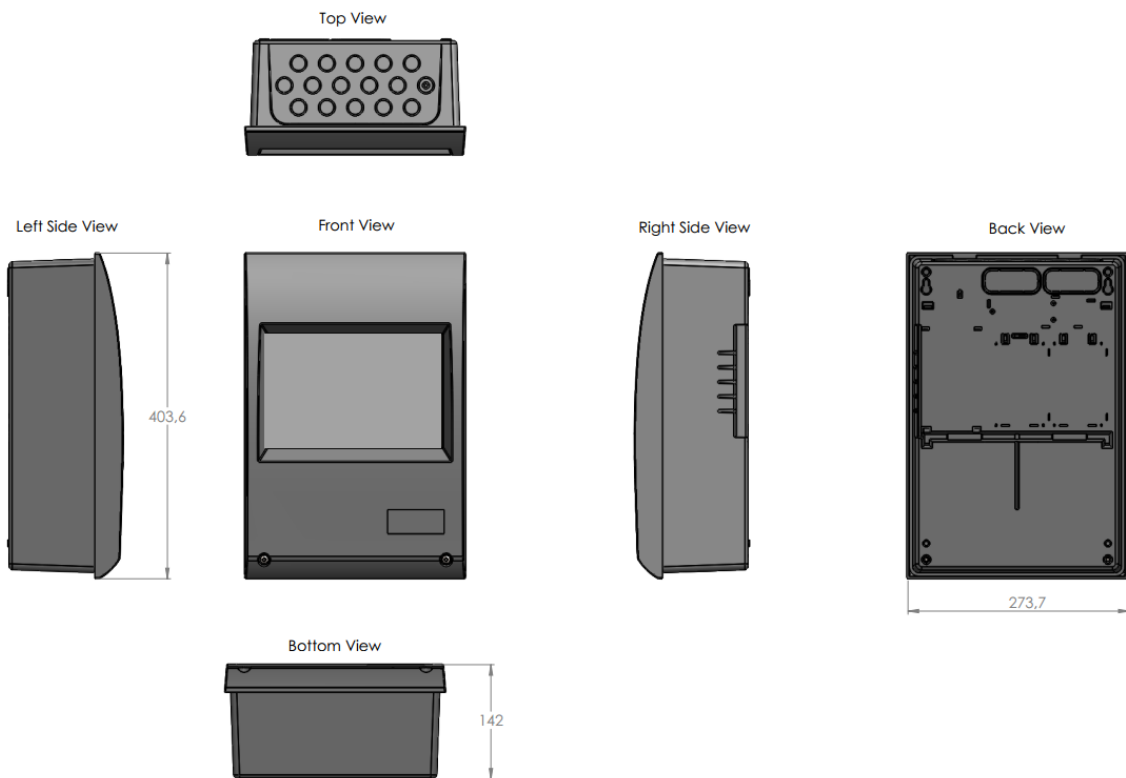

IDENTIFYING COMPONENTS

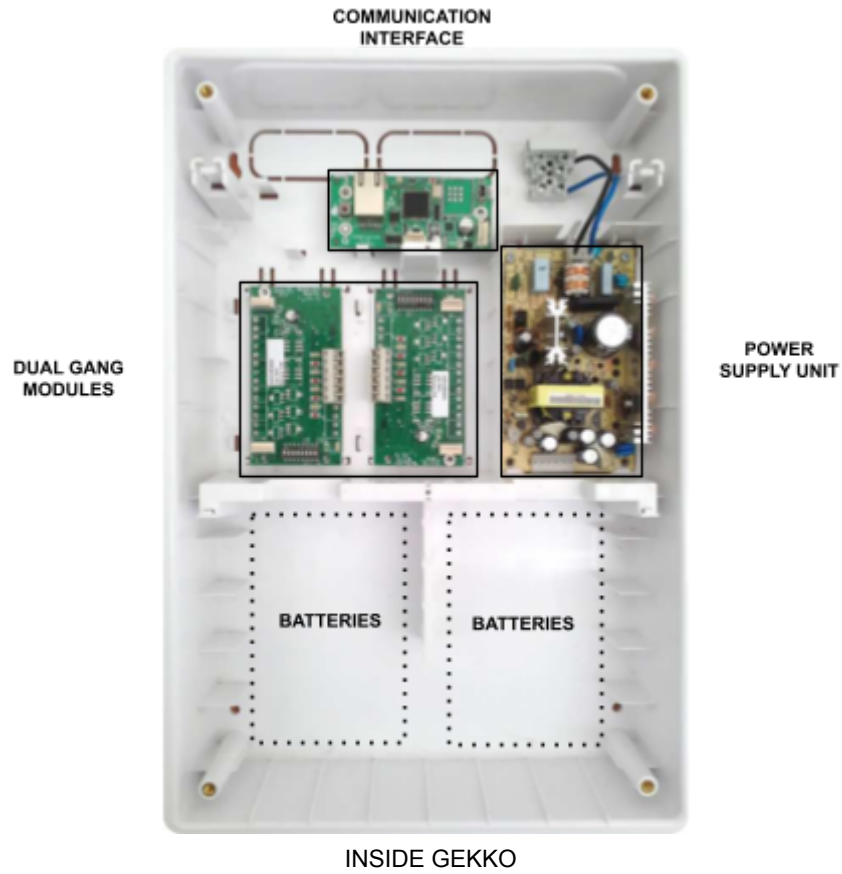

GEKKO MAIN BOARD

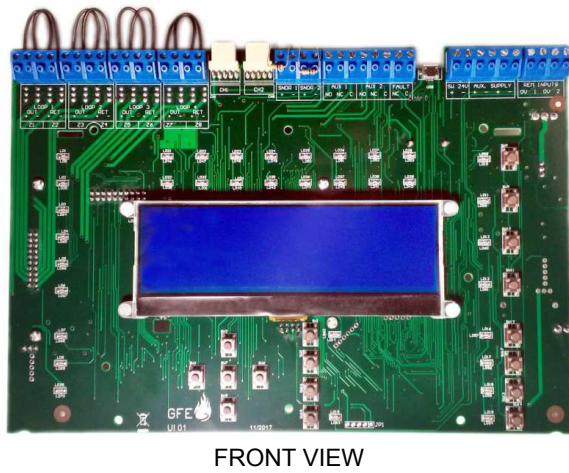

NOTE: GEKKO can only be networked with Chameleon panels.

COMMUNICATION INTERFACES

The following interfaces can be used to connect panels or repeaters to a Chameleon Network.

INTERFACE FOR RS422 COMMUNICATION

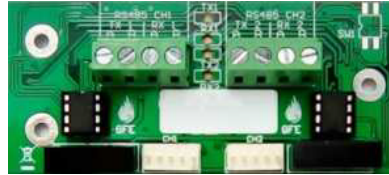

INT RS422 P2P-D

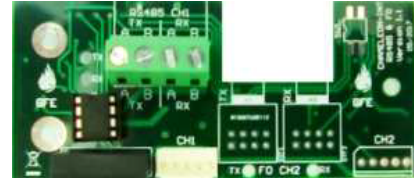

INT RS422 P2P-S

FIBRE-OPTIC INTERFACE



INT FO P2P-D

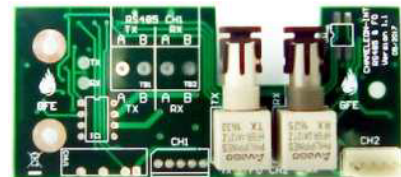

INT FO P2P-S

INTERFACE FOR TCP/IP COMMUNICATION



INT-TCP-P2P

MIXED INTERFACE

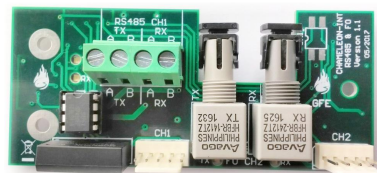

INT RS422 P2P/MIX FO

NOTE: For further installation guidelines or specific details, please refer to interface manual and/or Chameleon Communications Manual.

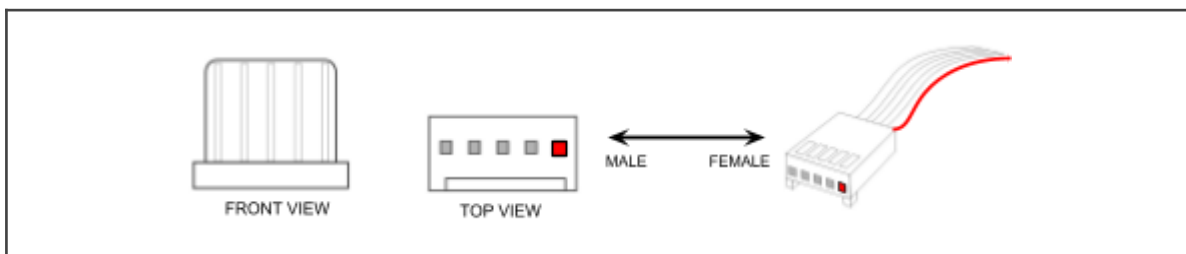

NOTE: Throughout the manual, the red pin on the 5 way molex indicates which pin is n°1.

EN54 INFORMATION

In accordance with EN54-2 1997/AC:1999 clause 13.7, the maximum number of sensors and/or manual call points in this panel shall not exceed 512 units.

The Fire Detection Control Panel complies with the requirements of EN 54-2: 1997 + AC: 1999 + A1:2006 and EN 54-4: 1997 + AC: 1999 + A1: 2002 + A2: 2006. In addition to the requirements of the above mentioned standard, the unit conforms to the following optional functions:

OPTION		EN54-2 Clause
Indication	Fault Signals from Points	8.3
Controls	Delays for activation of outputs	7.11
	Disablement of each Addressable point	9.5
	Test Condition	10
Outputs	Outputs to fire alarm devices	7.8

In addition to the functions required by the standard EN54-2 1997/AC:1999, the panel supports ancillary functions that are not required by the above mentioned standard, namely:

Ancillary Functions

Panel network connection ports

Panel to PC programming software (upload / download) port.

Auxiliary relays outputs

Analogue Loops

Each analogue loop can be connected to a maximum of 125 devices. According to EN54-2 clause 12.5.2, in case of a short circuit or interruption of the analogue detection loop, only a maximum of 32 detectors or call points per loop can be prevented at any one time of transmitting a fire alarm. In order to assure compliance with this clause, a loop isolator must be installed after every 32 detection devices.

SYSTEM LIMITATIONS

A fire alarm system can provide early warning of a developing fire, but it does not assure protection against damage or loss resulting from a fire.

The fire alarm system should be designed and installed in accordance with all relevant regulations and codes of practice.

To ensure maximum protection, the system **should be regularly tested and inspected by qualified fire alarm installation personnel**. Inspection and testing should be carried out in accordance with the appropriate local standards.

TERMS, DEFINITIONS AND ABBREVIATIONS

Analogue Loop - The physical link, usually fireproof 2 conductor shielded wiring cable, forming a ring of interconnection.

Flat Cable - A connecting lead. Typically a length of flat cable with connectors at both ends.

Conventional Sounder - A Conventional Sounder is an audible output device that is connected to the Conventional Sounder outputs on the Panel. It is different electrically from a Loop powered Sounder.

Serial Communication - Communications using RS422, RS232, Fibre Optic link or TCP/IP Serial Tunnel. It provides communications between the Panel and Repeaters. Chameleon Panels use Serial Communication as standard.

Detector - Any type of fire sensor (heat, smoke) that is connected to an Analogue Loop.

Device - A detector, sounder, interface module or call-point connected to an Analogue Loop.

Evacuation - A system state where all sounders are activated simultaneously. Pressing SOUNDERS ACTIVATE/SILENCE will generate a system evacuate condition.

Fibre Optic Link - A connection method for data that uses light instead of electrical signals. The connection is made using fibre optic cables rather than copper electrical cables. Fibre optic signals can travel far greater distances than electrical signals, with less risk of electromagnetic interference.

Flash - Non-volatile memory inside the panel used to store the program and the customer site data. Flash data storage is very robust and needs no power at all to retain the data.

Local Sounder - A local conventional sounder is an audible output device (bell or sounder) that is connected to the local bell output on the panel.

Loop Sounder - The term Loop Sounder is used to describe an audible output device that is connected to and controlled individually by an Analogue Loop. Loop Sounders are different electrically from Conventional Sounders.

NVRAM - Non-volatile Random Access Memory. Any information stored in this memory will not be cleared when power is removed from the system. It contains the LOG info, disablements, and system state info.

PCB - Printed Circuit Board.

Front End or Chameleon Display - Everything displayed in the Panel "Front End" is copied to the "Chameleon Display". It is only possible to mirror a local Panel "Front End" with a Chameleon Display. Every key press action is made as if the input was actually occurring on the connected panel "Front End". This solution is normally used on a single panel, not on networked panels.

Chameleon Repeater (system repeater) - In a Chameleon Network, the CHAMELEON REPEATER is used as a "System Repeater". It works as an addressed networked panel (without loops) and has the ability to process and register (log) all "system info". Everything that is displayed in any networked system panel, with the exception of zonal LEDs, will also be displayed on the Repeater Panel.

The System - All wired networked panels (GEKKO, OCTO+, NODE+ or CHAMELEON REP).

Zone - A situational group of devices. A Zone can consist of a collection of any of the devices connected to the system.

INSTALLATION

INTRODUCTION

This section covers the physical installation of the system. It primarily focuses on the parts that are required and how they should be connected together. Do not connect the mains power or the batteries at this stage; commissioning the system is covered in the next section of this manual. Installation should always be performed in accordance with a system plan.

CONTROL PANEL

The control panel should not be located where access to the internal components are restricted and where the unit is exposed to high levels of temperature, moisture, vibration and shock.

Any metal swarf could damage the PCBs. If any metal is present when the system is powered up, it is recommended that all PCBs are removed from their box whilst the box is being installed. Make a note of the positions of the PCBs before powering up the system.

Mains Power connection

All panels must be earthed. The LIVE connection must be made to the fused input on the power supply module. This input will have a Black or Brown wire leading into the power supply unit.

The input with a Blue wire leading into the power supply unit is the NEUTRAL.

Other Panel connections

These are detailed in the relevant following sections. Most connections are made from the GEKKO mainboard.

REPEATERS

Repeater Panels can be used. There are two options available:

1. **The Chameleon Display (isolated panel repeater):** Specific panel “extra display”.
2. **The Chameleon Repeater (system network repeater):** Used interleaved with the closed communications loop. It's a full featured “global” system repeater. It occupies an address on the network and behaves like a network panel but without devices plugged.

Both repeaters don't have a dedicated power supply. Each NODE+ (or OCTO+), is able to supply power to four repeaters. For more units an external power source must be added.

They should not be located where access to the internal components are restricted and where the unit is exposed to high levels of temperature, moisture, vibration and shock.

Avoid placing repeaters in direct sunlight as this may impair reading of the LCD display.

Any metal swarf could damage the PCBs. If any metal is present when the system is powered up, it is recommended that all PCBs are removed from their box whilst the box is being installed. Make a note of the positions of the PCBs before powering up the system.

PANEL CONNECTIONS



**ELECTRO-STATIC SENSITIVE DEVICES (ESD)
TAKE SUITABLE ESD PRECAUTIONS WHEN REMOVING OR
INSTALLING PRINTED CIRCUIT BOARDS.**

WARNING - observe ESD precautions when handling the PCBs.

GEKKO Main Board

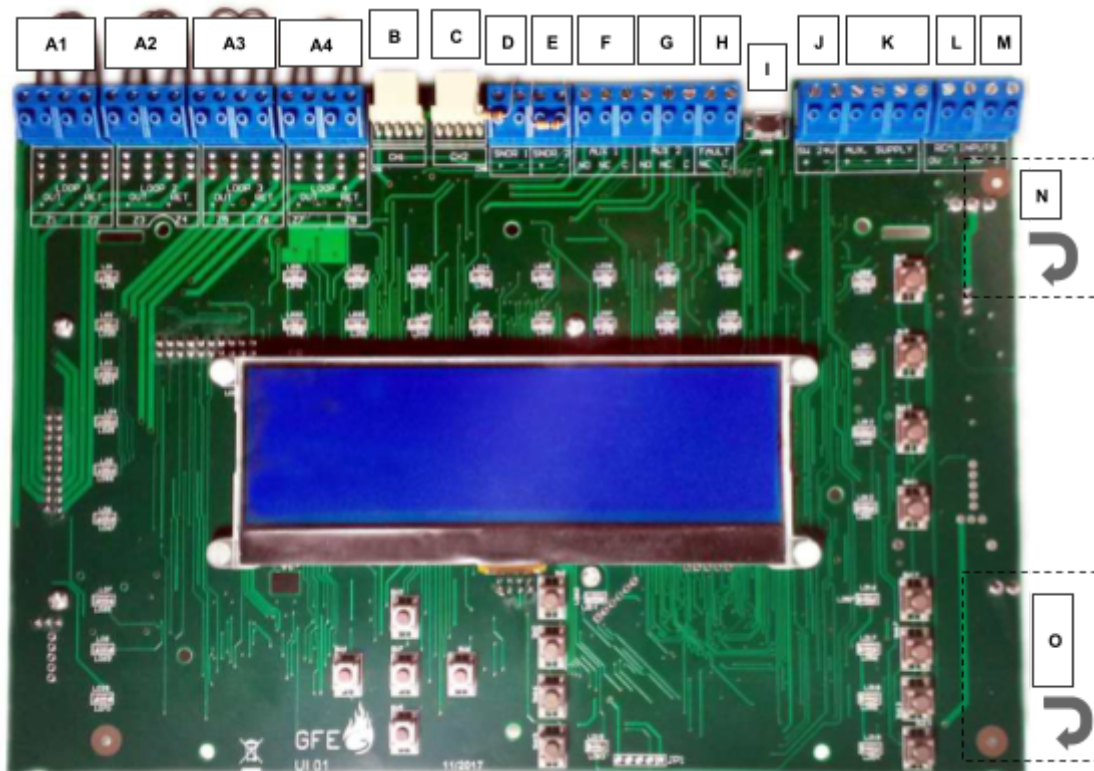

- A** - Loop connections. **A1** corresponds to Loop 1, **A2** to Loop 2, **A3** to Loop 3 and **A4** to Loop 4
- B** - Communication channel (CH1)
- C** - Communication channel (CH2)
- D** - Conventional sounder circuit 1
- E** - Conventional sounder circuit 2
- F** - Auxiliary change-over relay output 1(Activated by any fire present on the system, disabled by front button)
- G** - Auxiliary change-over relay output 2 (Activated by any fire present on the system, disabled by front button)
- H** - Fault NC relay contact (Activated by any fault present on the system, opens on fault)
- I** - MICRO USB Connector
- J** - Switched 24V auxiliary power supply (switches off, for 15 seconds @ every reset event)
- K** - 24V auxiliary power supply output for powering external devices.Max 300mA power limited and monitored
- L** - REM1 configurable input (Remote Evacuation, disable selected detectors, disabled, user access, class change)
- M** - REM2 configurable input (Remote Evacuation, disable selected detectors, disabled, user access, class change)
- N** - System power input
- O** - 24V battery connection

GEKKO Loop Card fitting

- 1 - This operation should only be performed by qualified personnel.
- 2 - Power to the panel should be completely removed, both primary and secondary (batteries) supplies, before the installation process of the card is initiated.
- 3 - After process is completed re-apply power to the panel.
- 4 - Panel should be in installation mode. Green (Status) LED should be flashing. *See function 8.4.1*
- 5 - Confirm using *function 7.1* that loops are detected by the panel.

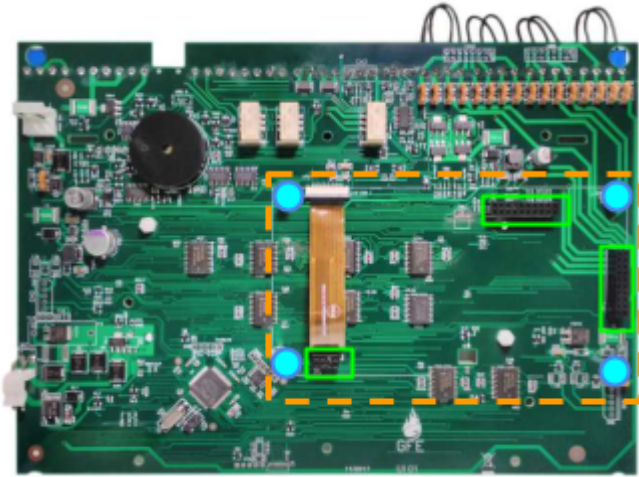

2 Male 20-way headers and 1 Male 8-way headers on expansion board should fit into the corresponding female headers situated at the back of the panel's main board.



Use 4 units of M3x5mm screws provided to fix GEKKO Loop Card.

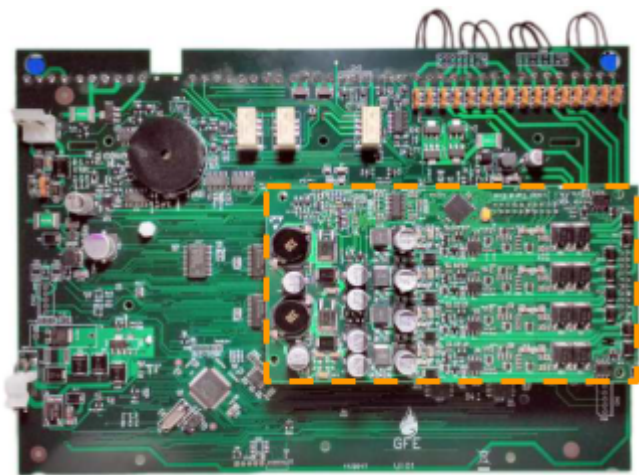

GEKKO Loop Card after fitting is completed.

COMMUNICATION CHANNELS

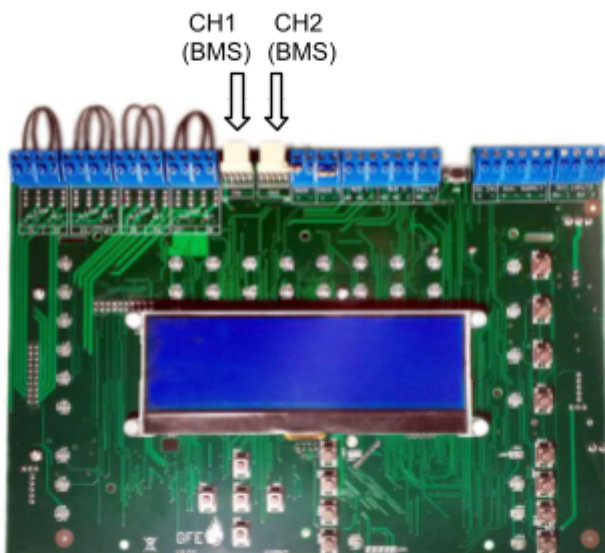

The GEKKO Panel may be incorporated into a Chameleon network. This also includes OCTO+, NODE+ or CHAMELEON REP. RS422, Fibre-Optic or TCP/IP connections may be used to connect them to a network.

Using CH1 and/or CH2 network connections port, the GEKKO panel can be extended with one or two simple Chameleon Display panels. RS422, Fibre-Optic or TCP/IP connection may be used to connect them.

Extra Display

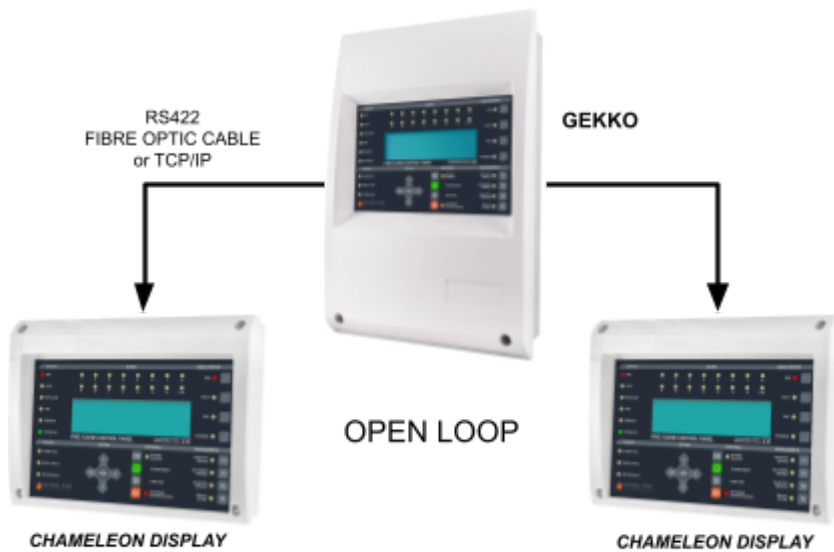

The Chameleon Display is commonly used when one or two simple display repeaters are needed on a “not networked” GEKKO.

NOTE:

- **Maximum two Chameleon Display connected.**
- **The Chameleon Display does not have a network address.**

Chameleon Displays are installed in a similar manner to Control Panels.

Each GEKKO panel can supply a maximum of 2 Chameleon Display repeaters.

The Repeater should not be located where access to the internal components is restricted and where the unit is not exposed to high levels of temperature, moisture, vibration and shock.

Avoid placing the Chameleon Display in direct sunlight as this may impair reading of the LCD display.

Network Repeaters

When you have a GEKKO integrated in a Chameleon Network system. A “network redundancy” should be used. To be able to achieve this, a CHAMELEON REP must be used as a repeater and connected in a “daisy chained” structure in a closed Loop, thus protecting the Data from interruptions or short circuits, by creating a bi-directional communications flow. If the panel loses communications with the repeater it will try via the opposite path.

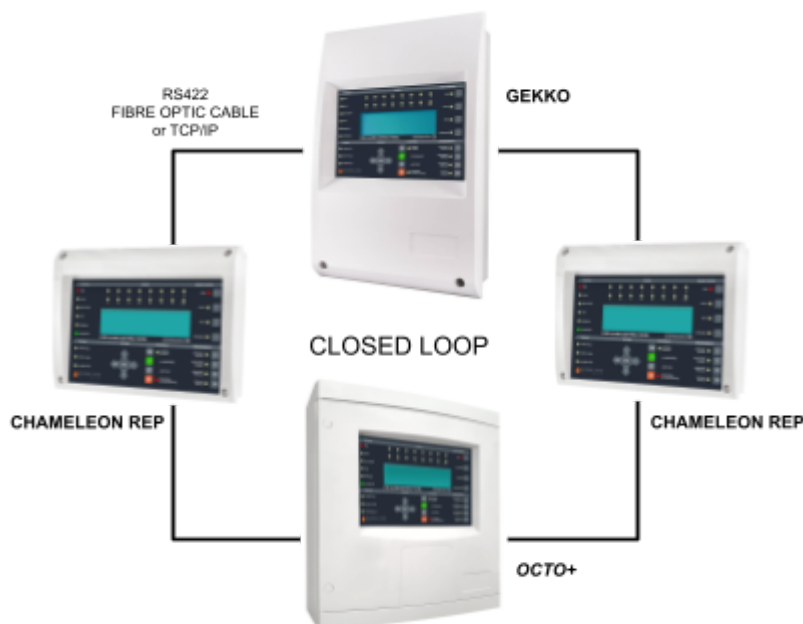

NOTE:

- **UP TO 32 CHAMELEON REP CAN BE CONNECTED.**
- **The CHAMELEON REP has its own network address.**

RS422 may be used for distances of up to 1200m. For longer distances (up to 4,5 km) Fibre Optic Data connections should be used. See page for cable requirements for both types of installation.

NOTE: For more detailed information please refer to the “Chameleon Communications Manual”

ANALOGUE LOOP(S)

The Analogue Loop provides the connection to all the analogue addressable devices and loop powered sounders. Unless the loop is completed the panel will not be able to monitor its integrity (open and short circuit monitoring).

Devices that can be fitted into the Analogue Loop include smoke sensors, heat sensors, Zone Monitoring Units (ZMU), I/O units, loop sounders and manual call-points.

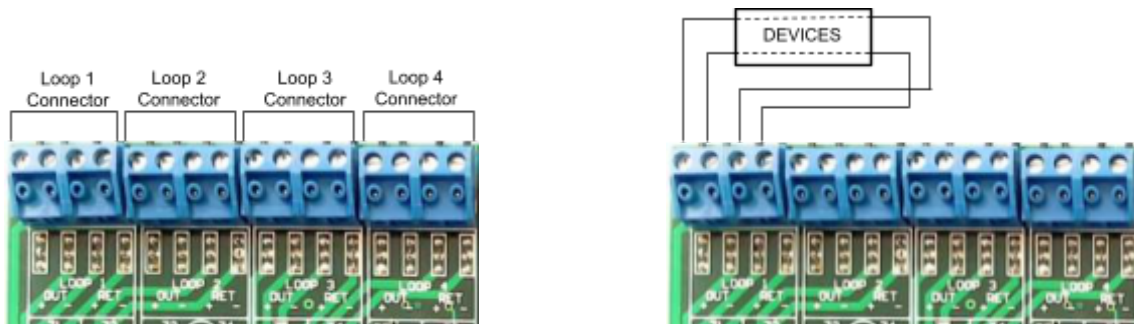

Refer to devices manual for connections diagrams. If no manual is available, make the connections as shown below:

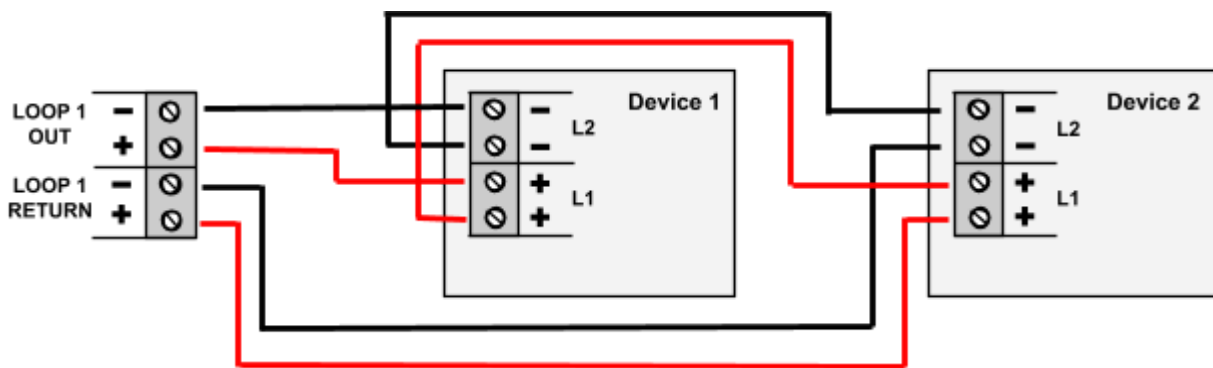

NOTE: A maximum of 32 manual call-points can be fitted into an Analogue loop. If this value is exceeded, the response time for certain types of call-points will be excessive.

For integrity of transmission paths, it is recommended the usage of short-circuit isolators on the Analogue Loop.

Such application is directly related with an installation physical layout, and should be applied accordingly in a way to limit the consequences of faults in the Analogue Loop.

The accepted consequences of faults using short-circuit isolators are specified in national guidelines for planning, design and installation of fire detection and fire alarm systems (codes of practice), etc. and may vary in different countries.

Nevertheless, it is recommended never to exceed 32 detection devices on the same path or zone without the usage of short-circuit isolators. Meaning that in an event of a short-circuit, no more than 32 detection devices should be affected.

For isolator device recommendation, search "isolators" on our website. Isolator example: GFE-AD-ISO.

CONVENTIONAL SOUNDERS

Conventional Sounders is the term used to describe conventional alarm sounders (or polarized bells) connected directly to a Panel. Loop-powered Sounders are different and are connected to the Analogue Loop.

Two Conventional Sounder circuits are provided on the Panel. More than one Conventional Sounder may be connected to each circuit. Max. current rating/Output is 500mA @ 28.5V DC nominal.

All Conventional Sounder circuits are monitored for open and short circuit faults. If a Conventional Sounder output is not used, then a 10K resistor must be connected across its output terminals.

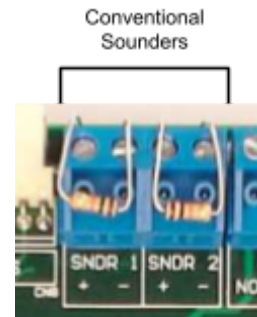

WARNING:

The total current load of all detection loops, sounder circuits and auxiliary supply outputs should not exceed the maximum power rating of the panel.

Please refer to the technical specification tables.

AUXILIARY FIRE RELAYS (2) AND FAULT RELAY (1)

Two auxiliary fire relay outputs are provided on the GEKKO Main board. These outputs are activated when a fire is detected (unless specifically inhibited). They are labeled AUX1 and AUX2. Under the presence of any Fire Alarm condition, these 2 relays will be energized. Both sets of contacts are of the change-over type. Max. contact current rating for each set of relay contacts is 2A @ 30V DC resistive / 0.5A @ 125V AC resistive.

One auxiliary fault relay output is also provided. This relay output will remain closed while there are no faults present in the system. Under any fault condition present, the relay will be de-energized and the relay contact will be open. The Fault relay is NC and it will open on any fault on the system.

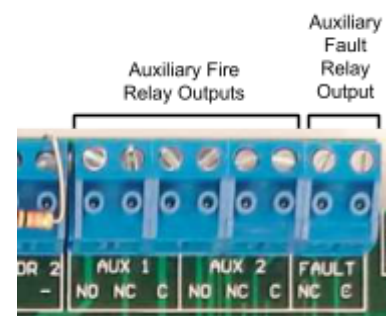

The contact ratings are:

2A @ 30V DC resistive / 0.5A @ 125V AC resistive.

WARNING:

Relay outputs are not supervised.

Please ensure that any wiring connected to these outputs is power limited.

PANEL BATTERIES

It is recommended that the batteries are fitted at the end of commissioning the system, otherwise it can be difficult to remove the power quickly if there is a problem.

The batteries are connected to the GEKKO main board. This battery connection not only supplies the panel with power if primary supply fails, it also provides a charging output to maintain the batteries in a fully charged state.

Before connecting the batteries, check voltage across the battery connection terminals. The value should be 27.5V +/- 0.5V.

NOTE: Arcing and fire risk. Never short circuit the battery terminals. Always connect the blue wire between the batteries last.

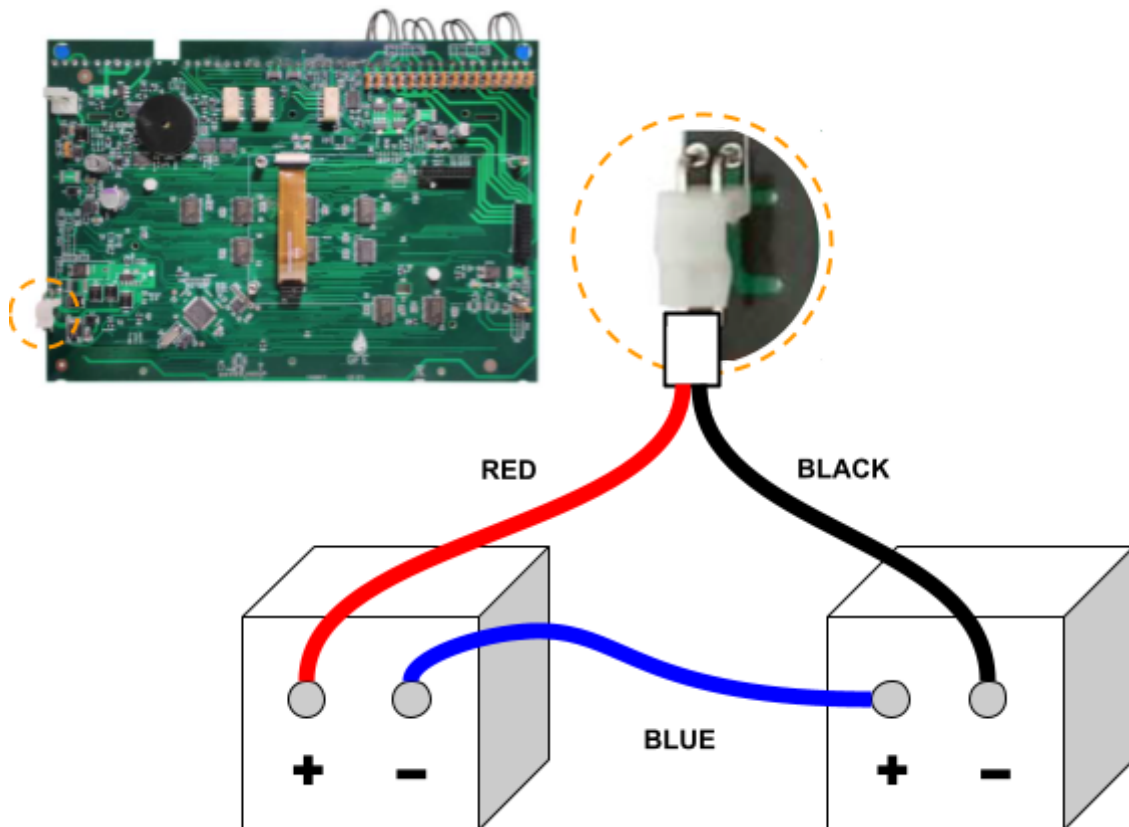

RECOMMENDED CABLES

Analogue Loops, Conventional Sounders and Data Loops

Fire rated Cables for Loops and Sounder Circuits

AEI type Firetec Multicore Ref. F1C1 (1 mm²) to F1C2.5 (1.5 mm²) in 2 core

AEI type Firetec Armoured Ref. F2C1 (1.5 mm²) to F2C2.5 (1.5 mm²) in 2 core

AEI type Mineral Insulated Cable (all types up to 1.5 mm²)

BICC types Mineral Insulated twin twisted conductor cables, Ref. CCM2T1RG and CCM2T1.5 RG

BICC types Mineral Insulated Pyrotenax (all types up to 1.5 mm²)

CALFLEX type Calflam CWZ 2 core type up to 1.5 mm²

PIRELLI type FP200 Gold 2 core type from 1 mm² to 1.5 mm²

FIRETUF (OHLS) FTZ up to 1.5 mm². Manufactured by Draka

All cables must be screened

Minimum detection loop conductor section size is 0.5 sq.mm

Maximum detection loop conductor section size is 1.5 sq.mm

There should only be one analogue detector loop per shielded cable.

Analogue detector loops and conventional sounders should not run in the same shielded cable.

If the system requires one or more repeaters, it will be necessary to use a four core data cable to create a data loop between the panel and the repeater. Alternatively, it is possible to use multi-mode dual-core fibre-optic cable or a TCP/IP connection for the same purpose.

All earth screened cables should have a proper connection.

A connection board or an earth bar can be used to fit all together.

Cable Glands: M20x1.5 IP65 4-9mm (recommended)

RS422

Serial communication cable should be minimum SF/UTP cat.5e grade data cable,

eg: FIRETUF 128690NN SF/UTP Cat."5" FB 90 (mbzh) by Draka

Fibre Optic

Multi-mode Dual Core sheathed fire proof with 62,5µ/125µ fibre terminated in ST connectors

COMMISSIONING

INTRODUCTION

Commissioning involves checking that all connections have been properly made and all hardware is functioning correctly. This means the system must be initially installed in accordance with the previous section of this manual.

The panel default mode is 'Installation mode'. In Installation Mode the green SYSTEM ON LED will flash on and off. The panel will automatically detect and memorize all the devices connected to the loop in the system in "real time". No extra action is needed.

With the panel on default the system will be ready to operate and detect a Fire incident from the moment power is switched on. Therefore, the system will be fully functional without any additional setting up. All further actions will tailor it to the requirements of the specific installation at hand.

Once the connections and hardware have been checked it is possible to get the basic fire alarm system up and running very quickly - **it is only necessary to have the system in Installation Mode for 120 seconds then set the system to 'Active Mode'**. Programming of the system to provide more advanced functionality is covered in the next section.

THE PANEL BUTTONS



CONTROLS

BUZZER SILENCE

The occurrence of any new fire or fault condition will initiate the operation of the internal buzzer. By pressing this switch, the operation of the buzzer will be stopped until a new fire or fault appears on the system.

SYSTEM RESET

Soft resets the entire system. A soft reset should be satisfactory under almost all circumstances, however a Master Reset can be performed by cycling the power on the Panel (removing both primary AC and secondary DC supplies).

NOTE: If an alarm has been detected, it is necessary to silence the alarms using SOUNDER SILENCE before the SYSTEM RESET button will operate.

LAMP TEST

General User Access (no code entry required). Lights all the LEDs, turns on the LCD back light and sets all display pixels to black. Lamp test only operates whilst the key is depressed.

SOUNDERS ACTIVATE / SILENCE

Activates all sounders. A second press deactivates all sounders. The adjacent LED is ON whilst the sounders are activated. It is possible to define if pressing the SOUND ALARMS button will activate the system's Fire I/O's.

DISABLEMENTS

AUXILIARY RELAYS

When this button is activated all relays and I/O modules connected to the system have their outputs disabled. This includes the normally energized FAULT relay, the FAULT I/O group and all ALARM I/O groups. When these outputs are disabled the button LED is ON. Pressing the button again restores normal relay and I/O module operation.

NOTE: IF I/O'S ARE TO BE ACTIVATED BY EVAC. CONDITION, THIS WILL OVERRIDE THE DISABLEMENT.

SOUNDERS DISABLE

When this button is activated, all sounders will be disabled and the LED will be lit. Pressing it again will re-enable the sounders and the LED will turn off.

SELECTED DETECTORS

Via the programming menus, individual sensors may have selective disablement turned on. When this button is activated, those sensors that have selective disablement turned on will not generate a fire alarm condition. When activated, the adjacent LED is ON. If no devices have selective disablement turned on, then pressing this button will have no effect. Pressing the button again restores normal sensor operation.

DELAYS ACTIVE

Only when this button is active (and the adjacent LED ON), Sounders and I/Os delays will operate.

Pressing the button again will deactivate the delays and will result in immediate sounder and I/O operation.

Under any fire condition the delays will be activated. If during the course of these delays this button is pressed, the delays will be overridden and the sounders, together with any other fire indicating equipment, will be activated.

QUEUE REVIEW

FIRE - General User Access (no code entry required)

If more than one fire has been detected, then the LED next to this button will flash. Press the button to step through all detected fires. Once all fires have been reviewed, the LED will be constantly ON. Subsequent fires will be added to the end of the queue and the LED will start to flash again. After each button press the information will be displayed for 20 seconds. After that time the screen will revert back to the first fire.

FAULT - General User Access (no code entry required)

If more than one fault has been detected, or if a fault and fire have been detected, then the LED next to this button will flash. Press the button to step through all reported faults. Once all faults have been reviewed, the LED will be constantly ON. Subsequent faults will be added to the end of the queue and the LED will start to flash again. After each button press the information will be displayed for 20 seconds. After that the screen will revert back to the first fault (or fire).

TEST - General User Access (no code entry required)

If the LED next to this button is ON, then a test mode has been selected via the programming menus. Pressing the button will show which sounders and zones have been set to test mode. If there are more zones under test that can be displayed, then pressing the button again will show the next set of zones under test. The information is displayed for 15 seconds before the default display is restored.

NOTE: A SYSTEM RESET will clear all test modes.

DISABLED - General User Access (no code entry required)

If the LED next to this button is ON then there is at least one disablement active in the system. Pressing the button will display the disablements. If there are more disablements that can be displayed, then pressing the button again will show the next set of disablements and so on.

The information is displayed for 15 seconds before the default display is restored.

Possible disablements include - auxiliary relays, loops, zones, detectors and sounders.

GETTING THE PANEL RUNNING

Apply AC power to the Panel.

The LCD should display the splashscreen image with the Panel Logo. This will be followed by the date and time (and the company name if it has been set). Within a few seconds faults will be reported, these will overwrite the date and time (and company name).

The SYSTEM LED should be flashing green. This indicates that the system is in Installation Mode. If the LED is solid green the system is in Active Mode and needs to be put into Installation Mode - refer to the programming section for details on how to do this.

If the SYSTEM LED is flashing and information is being displayed on the LCD then the Panel is functional.

GETTING AN EXTERNAL CHAMELEON DISPLAY RUNNING

The supply to the remote display can be obtained directly from the auxiliary power supply output on the panel. Start by connecting the power to the remote display.

If the panel is powered up and the serial communication connections between panel and the display(s) are properly made (through RS422 or Optical Fibre), the information shown on the LCD as well as all LED indicator status from the panel will replicate itself on the remote display (Chameleon Display).

Press the SYSTEM RESET switch and you should see on the LCD display the Splash Screen Image.

If after a few seconds upon completion of the initialization phase, the LCD display shows the message "NO COMMS TO PANEL" and the FAULT LED is lit-up, verify the condition of the panel. If it is powered up and working properly then verify the network connections.

GETTING A CHAMELEON REPEATER PANEL RUNNING

The supply to the Repeater can be obtained directly from the auxiliary power supply output on the panel (source panel). Start by connecting the power to the Repeater.

Press the SYSTEM RESET switch and you should see on the LCD display the message "GEKKO" .

Please refer to the Chameleon Communications Manual for network troubleshooting.

GETTING INTO PROGRAMMING MODE (ACCESS LEVEL 3)

When the Panel is powered up, it will be necessary to enter the panel programming mode. Familiarize yourself with this section before proceeding to the next section in the manual and powering up the panel.

Programming mode is accessed via the front panel keypad, as pictured below.

To program device and zone text messages, it is essential to use the Chameleon Connector PC based software.

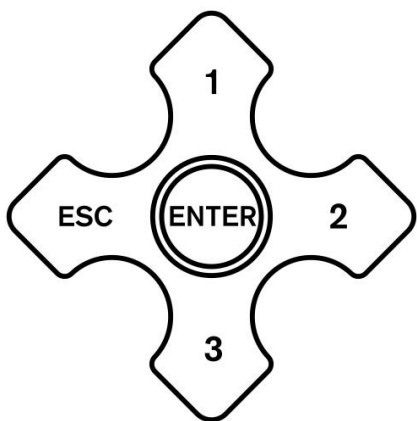

Logging In

To enter programming mode you need to log in.

The Panel must be powered up and must have initialized itself i.e. NOT showing the hourglass symbol.

Press ENTER on the Keypad. You must now insert your Installer access code. See page related to Access Levels. You have unlimited attempts but if code entry is not started within 10 seconds then the panel will revert back to its default screen. While entering the code you are allowed up to 5 seconds between key presses.

Function Selection

The programming functions are arranged using a menu system.

To select a function or sub-menu use either ▲ or ▼ and **ENTER**.

ESC takes you back a menu level.

When required use the ► to scroll through loops.

The top level menus are:

- 1 Review Historic Log
- 3 Zones - Disable & Assign
- 4 Sounders - Disable & Assign
- 5 Input/Output - Disable & Assign
- 6 Device Set-up
- 7 Monitor Device Counts & Test
- 8 General

Most functions operate in a consistent manner using the standard keys. The item that is being changed is usually highlighted with a flashing cursor.

GETTING THE SYSTEM RUNNING

1. Ensure all connectors are firmly in place. Ensure that all connections are tight, with no stray strands of wire.
2. If a Loop Card has been added to the panel, please ensure that it's securely fitted to the back of the panel's Main Board.
3. Power up the Panel.
4. Ensure that the Panel is in Installation Mode (SYSTEM ON LED flashing). If not, enter programming mode and select function 8-4-1 Active/Installation Mode and place the panel into Installation Mode.
5. Press SYSTEM RESET.

Communications Check

Confirm that all Repeaters and Panels are showing identical information (LEDs and LCD), and that you can see on menu "8-5-2 Known Panels" all the network. Repeat this procedure in all system panels.

Panel Check

Press and hold LAMP TEST on the Panel.

All the LEDs should light, the LCD backlight should turn on and all pixels on the LCD should be black.

Learning Which Devices Are Fitted

1. Enter programming mode. (See page *Access Levels, Installer Access Code*)
2. Confirm if the panel's protocol is properly selected to enable full compatibility with installed devices.
3. Select function "8-3-2 Clear Non-Volatile RAM" and clear the NVRAM.
4. Exit Programming mode.
5. Press SYSTEM RESET.
6. Wait 90 seconds for the system to automatically learn which devices are present and report any faults.
7. A SYSTEM RESET or MASTER RESET results in:
 - o **First:** An analogue loop power off period of 8 seconds [reset];
 - o **Second:** An analogue loop charge up of 15 seconds;
 - o **Last:** Loop polling starting.
8. Review the faults (using the FAULT QUEUE REVIEW key if there is more than one). Note down the messages then remove power and rectify the faults.
9. Power up the system, let it initialize and enter programming mode.
10. Select function 7-1 Device Count, Type and Value.
11. Use ▲ or ▼ to select the device, confirm that all devices are present. If the Loop Card fitted has more than 1 loop, use the ► to scroll through loops and verify the presence and proper operation of all devices fitted to this loop.
12. Once all faults have been cleared and the system has been in Installation Mode for 120 seconds, then the system can be put into Active Mode.
13. Note that there is no clear end to Installation mode because the system is constantly looking and learning. However if the system is put into Active Mode and Installation Mode hasn't had time to identify all system components, you will very quickly be greeted with error reports regarding unexpected devices.
14. If devices are ever removed, replaced or added then Installation Mode must be selected so that the system can learn a new configuration. If you do not do this the system will report a fault or missing devices.

NOTE: *New Self Addressable Devices need a different installation process because they need to be assigned addresses before the panel can learn that they are present. This procedure is covered later in this manual in the section entitled "6-4 Automatic Address Setting".*

Sounder Audibility Check

If the building is unoccupied then press SOUND ALARMS. All sounders should operate until the button is pressed again.

Confirm that this is the case.

If the building is occupied it is strongly recommended that the test sounders functions in programming mode are used. Enter programming mode and select 7-2 Test Sounders. Using this function, all the sounders can be checked.

The Panel's Conventional and Loop Sounders will sound for 1 second and then be silenced for 9 seconds.

Analogue Loop Monitoring

Check if a short circuit or open circuit is detected on any of the Analogue Loops.

Open Circuit Test

Disconnect either the + or the - OUT from the Loop terminal. The connection is found on the Panel's Main board.

Within a few seconds, a circuit fault should be reported. No individual detector faults should be reported. Reconnect the wires and press SYSTEM RESET to clear the fault reports.

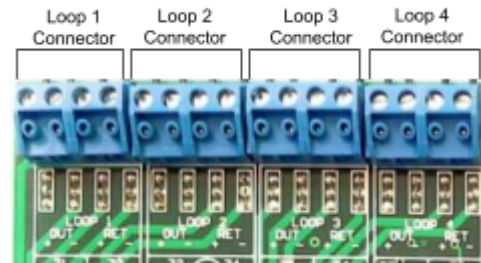

Conventional Sounder Monitoring

Panels have two Conventional Sounder circuits.

Check the Conventional Sounder circuits for open and short circuit fault detection.

To perform the Open-Circuit test, disconnect either the + or - connection at each conventional sounder circuit.

To perform the Short-Circuit test, connect for each sounder circuit a wire link, connecting both the + and - terminals together. With either test, after a few seconds, a fault message will appear on the LCD display of both the panel and repeater(s) indicating that the conventional sounder circuit is at fault.

Both the FAULT and ALARM FAULT LED indicators will be lit.

Restore the original connections and press SYSTEM RESET to clear all the error reports.

WARNING:

If the Conventional Sounder outputs are short circuited while the sounders are active, the electronic overload protection is tripped and the system will report a sounder fault turning ON the ALARM FAULT LED simultaneously. Once the short circuit is cleared, a system reset will clear the faults.

Detector Tests

If the devices have been assigned to Zones (via the programming menus) then it is possible to test the detectors with limited or no sounder operation.

Detector Tests By Zone

1. Before starting clear all faults, put the system into programming Mode, and press SYSTEM RESET.
2. In programming mode, select function 7-3 Sounders on Test Activation. This allows you to choose an audible confirmation that a device has detected a fire. The audible confirmation consists of a 1 second period of sounder operation.
3. ALL SOUNDERS ON DETECTOR TEST activates the Panel' Conventional and Loop Sounders.
4. Now select function 7-4 Test Zones to select the Zones which will be tested.
5. Exit programming mode, but DO NOT press SYSTEM RESET as this clears all test modes.
6. In test mode, whenever a detector is activated the LED on that detector will be ON and the event will be reported on the panel for 15 seconds. If selected, the sounders will also operate for 1 second.
7. Pressing TEST (QUEUE REVIEW) will report the Zones that are in Test Mode.

Unassigned Detector Tests

1. If the detectors have not been assigned to a Zone then they can only be tested in normal (Active) mode. Using the programming menu, ensure the system is set to Active Mode, then exit programming mode and press SYSTEM RESET.
2. Carry out a fire test on each detector. Confirm the LED lights on the detector under test. Confirm that the fire is reported correctly at the Panel (and any Repeaters). Confirm that the sounders operate.
3. Note that sounders and detectors can be inhibited or delayed using the advanced features in the programming menus. If the sounders do not operate as expected, first verify all the settings for the sounders and the device under test.

At this point you may program the more advanced features of the system. The basics usually involve assigning text labels to the devices and Zones.

WRAPPING UP INSTALLATION AND COMMISSIONING

Once you have completed the installation, do not forget to carry out the following steps:

1. Connect the batteries to the Panel as described in the Installation section of this manual.
2. Test that the battery monitoring is functional by temporarily removing the blue wire between the batteries. After a few seconds the fault should be reported on the Panel.
3. When the blue wires are reconnected pressing SYSTEM RESET should clear the fault report.
4. Test that the primary supply monitoring is functional and that the battery system works. Switch off the AC supply to each power supply unit in the Panel. After a few seconds the fault should be reported on the Panel.
5. Reconnect the AC supplies and press SYSTEM RESET.
6. Confirm that the system is in Active Mode - the SYSTEM ON LED is permanently lit.

Battery Fault Message Test

This test should be performed for each set of batteries. Test only the actual battery connections.

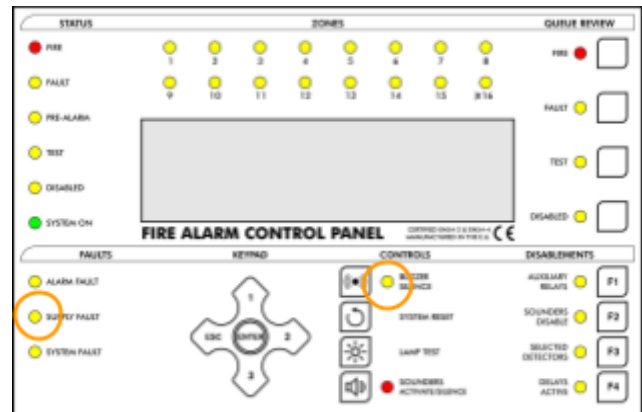
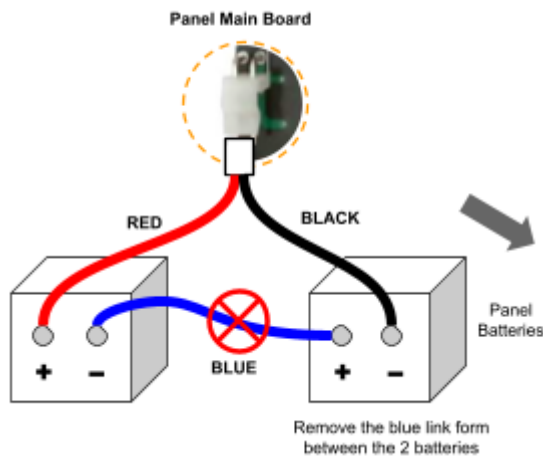

After a short delay, the SUPPLY FAULT LED will be ON, the panel buzzer sounds and the "Battery Fault" message appears on the LCD Display.

Replace the link between the batteries and reset the panel (SYSTEM RESET) to clear the fault indication.

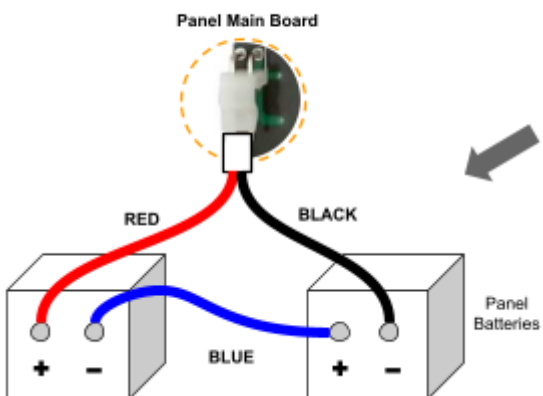

Power Failure Test

Carry out this test to check that the battery system works correctly when power fails.

Switch off the mains supply to the panel. After a short delay, the amber SUPPLY FAULT LED will be ON and the LCD displays the message "Primary Supply Fault". The fault buzzer sounds.

Switch the mains supply back on and press the SYSTEM RESET switch. The SUPPLY FAULT LED extinguishes, the fault message is removed from the LCD, and the buzzer stops sounding.

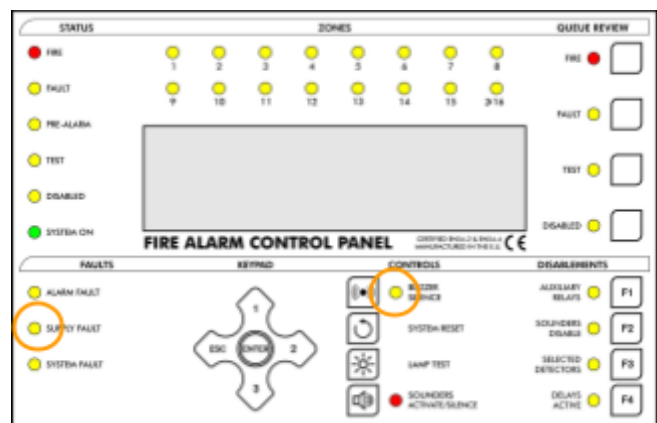

PROGRAMMING FUNCTIONS

COMPLETE LIST OF FUNCTIONS

- 1 Review Historic Log
 - 1-1 Display Historic Log
 - 1-3 Clear Historic Log
 - 1-5 Read/Clear Autostart Count
- 3 Zones - Disable & Assign
 - 3-1 Disable Zones
 - 3-2 Assign Sounder Groups to Zones
 - 3-3 Assign I/O Groups to Zones
 - 3-4 Assign Zone to Device
 - 3-5 Zone Sounder Delay Set-up
- 4 Sounders - Disable & Assign
 - 4-1 Sounder Configuration
 - 4-2 Configure Sounder Groups
 - 4-3 Disable Sounders
 - 4-4 Assign Sounder Group to Device
 - 4-5 Inhibit Sounders for Device
 - 4-6 Sounder Delay Set-up
 - 4-7 Override Sounder Delays
- 5 Input/Output - Disable & Assign
 - 5-1 Configure I/O Groups
 - 5-2 Select Fault I/O Group
 - 5-3 Assign I/O Group to Device
 - 5-4 Inhibit I/O for Device
 - 5-5 I/O Unit Action upon Evacuate
 - 5-6 I/O Unit Delay or Immediate
 - 5-7 I/O Delay Set-up
 - 5-8 Select Disable I/O Group
 - 5-9 Configure Remote Inputs
- 6 Device Set-up
 - 6-1 General
 - 6-1-1 Disable Loops
 - 6-1-2 Device Disable
 - 6-1-3 Set Selective Disablement
 - 6-1-4 Set Device Reporting Details
 - 6-1-5 Set Immediate Evacuate for Device
 - 6-1-6 Device Activation Overrides Delays
 - 6-1-7 Inhibit Auxiliary Relays
 - 6-1-8 Global Behaviour Set-up
 - 6-1-9 Configure Timed Behaviour
 - 6-3 Device Specific - Functions for ZEOS Protocol
 - 6-3-1 Select Device Behaviour Mode
 - 6-3-2 Flashing Leds On/ Off
 - 6-3-3 Disable Specific Flashing Leds
 - 6-3-4 Re-calibrate All Devices
 - 6-3-5 Check for Devices Needing Service
 - 6-3-6 Read Data Stored in Device
 - 6-3-7 Write Data Stored in Device
 - 6-3-8 Select Device Smoke Sensitivity
 - 6-3-9 Select Device Heat Grade
 - 6-4 Automatic Address Setting(ASET)
 - 6-4-1 Activate ASET Mode
 - 6-4-2 Clear Loop
 - 6-4-3 Clear Device
- 7 Monitor Device Counts & Test
 - 7-1 Device Count, Type & Value
 - 7-2 Test Sounders
 - 7-3 Sounders on Test Activation
 - 7-4 Test Zones
 - 7-6 Light LED on device
- 8 General
 - 8-1 Time/Date & Timers
 - 8-1-1 Set Date & Time
 - 8-1-2 Define Day & Night
 - 8-1-3 Delays Off at Night
 - 8-1-4 Configure Evacuate Timer
 - 8-1-5 Device Starts Evacuate Timer
 - 8-1-6 Enable / disable delay
 - 8-1-7 Configure Extended Delays
 - 8-1-8 Configure Disablement Timer
 - 8-2 Special Features Set-up
 - 8-2-1 Two Devices to Evacuate
 - 8-2-2 Call Points to Evacuate
 - 8-3 Memory - BEWARE, ENGINEERS ONLY
 - 8-3-1 Checksums
 - 8-3-2 Clear Non-Volatile RAM
 - 8-3-3 Calculate Customer Flash Checksum
 - 8-3-4 Calculate Program Flash Checksum
 - 8-4 Other Features
 - 8-4-1 Active/Installation Mode
 - 8-4-4 Set User Access Code
 - 8-4-5 Set User Functions
 - 8-4-6 Select language
 - 8-4-8 Set Installer Access Code
 - 8-4-9 Set Master Access Code
 - 8-5 Network Configuration
 - 8-5-1 Configure Panel Number
 - 8-5-2 Known Panels
 - 8-5-3 Installation Status
 - 8-5-4 Broadcast Configuration
 - 8-5-5 Communication Channels
 - 8-5-6 BMS Setup
 - 8-9 Version Information

Keys to use within functions

Most functions use some or all of the following keys:

- | | |
|--------------|--|
| 1, 3 | Used to browse through items. |
| 2 | Often used to change fields (move the cursor). It will also be used when required to scroll through loops. |
| ENTER | Used to select items and store changes. |
| ESC | Used to abort changes and exit. |

The cursor is often shown to highlight the item that is being changed.

Help

Where possible, help is displayed automatically.

General

Because of the flexibility and functionality of this panel, sometimes it can be quite hard to establish the desired configuration. Zone, device and group events interact as do the various timers.

If the system does not seem to operate as intended, please take your time and review the various sections in this manual.

Some settings need the front panel buttons to be activated, whilst others can be inhibited for specific devices.

The basic functionality of the panel is readily available and the fire alarm system will be operational just by supplying it with electrical power. Exercising cause and effect capability is what this section is all about. The best way to become familiar with all the programming facilities of this panel will be a hands-on approach, aided closely by this manual.

PROGRAMING FUNCTIONS DESCRIPTION

1 Review Historic Log

All the functions associated with reviewing or printing events and settings.

1-1 Display Historic Log

The panel logs all events in an internal event log. It can store a rolling 10000 entries. When it is full, the latest entry is added and the oldest entry discarded.

Help is automatically displayed on entry to the function, because it is not possible to display a log entry and help at the same time.

To select a specific entry, input the number and then press ENTER.

1-3 Clear Historic Log

Clears the Historic Log. Only if logged in with Master access code.

1-5 Read/Clear Autostart Count

Every time the Panel's power is cycled, the Autostart count is incremented. SYSTEM RESETs from the front panel button do not increment the Autostart count.

3 Zones - Disable & Assign

All the functions associated with managing Zones.

3-1 Disable Zones

Allows you to disable or enable Zones.

All devices in disabled Zones will cease to operate with the exception of the (audible) output from loop sounders.

Any Zones that are disabled will also be indicated when programming mode is exited. They can then be reviewed using the DISABLED (QUEUE REVIEW) button.

3-2 Assign Sounder Groups to Zones

Sounder Groups (set up using the Sounders programming functions) can be assigned to Zones.

Each Zone can be assigned two sounder groups. The first Sounder Group is activated when the first fire is detected, the second Sounder Group is activated when a second fire is detected in the same Zone.

3-3 Assign I/O Groups to Zones

I/O Groups (set up using the I/O programming functions) can be assigned to Zones.

The first 4 I/O groups are activated when the first fire is detected, the 5th I/O group is activated when a second fire is detected in the same Zone.

The details of the activation are set up using the I/O programming functions.

3-4 Assign Zone to Device

Allows the detection Zone to be defined.

Select which devices make up which Zones. If a device has a text label, it will be displayed. If a Zone has a text label, it will also be displayed.

Up to 384 Zones can be defined.

Zone 000 is not a Zone and indicates no Zone has been assigned.

3-5 Zone Sounder Delay Set-up

Allows the sounder activation delay to be enabled or disabled for each specific Zone.

Note that this delay will only occur if the following has also been set:

- Sounder programming function 4-6: The sounder delay period is set, the delay is set to ZONAL MODE and the devices that initiate the delay have been specified.
- The front panel ACTIVE DELAYS button has been set to on (LED lit).

NOTE: Specific devices in the Zone can be set to override this delay.

4 Sounders - Disable & Assign

4-1 Sounder Configuration

Allows selection of PRESET or PROGRAMMED sounder operation.

Selecting PRESET (the default) will result in all sounders being operated; any Sounder Group settings will be ignored.

NOTE: The Sounder Groups must be defined when PROGRAMMED is selected, because the default group settings have all sounders set to silent. PRESET or PROGRAMMED does not affect any sounder delay settings.

4-2 Configure Sounder Groups

Allows all the Sounder Groups to be defined. A Sounder Group can consist of any combination of sounders. 512 Sounder Groups can be defined.

For each sounder:

- 'C' indicates continuous operation.
- 'S' indicates silent (no) operation.
- 'P' indicates pulsing operation.

A Sounder Group can assign Conventional Sounder outputs and/or Loop Sounders in the loop. Group 512 is the Common Sounder Group. This is always operated when Sounder Group operation is turned on and a fire occurs.

When a fire occurs, all the Sounder Group information for the detector in fire is combined: the device Sounder Group is combined with the Zone Sounder Group and the Common Sounder Group. 'P' pulsing will override 'S' silent and 'C' continuous will override 'P' pulsing.

When a subsequent fire occurs, the new Sounder Group information is added to the existing Sounder Group information. 'P' pulsing will override 'S' silent and 'C' continuous will override 'P' pulsing.

NOTE:

- ***If Sounder Groups are defined then it is essential to set 4-1 Sounder Configuration to PROGRAMMED, otherwise all the system sounders will be activated by any fire event.***
- ***Individual detectors can be set not to activate Common Sounder Groups, Zone Sounder Groups or all sounders. See function 4-5 Inhibit Sounders for Device.***
- ***If evacuate is operated (by setting CALL-POINTS to evacuate, then activating a CALL-POINT, for example) the sounders will operate as if the sounder configuration were set to PRESET.***

4-3 Disable Sounders

Allows specific sounders to be disabled or Enabled.

Disabled sounders will not be operated regardless of Sounder Configuration, Sounder Groups and evacuate requests.

'E' indicates enabled

'D' indicates disabled

When programming mode is exited, all sounders that have been disabled can be reviewed using the DISABLED (QUEUE REVIEW) button.

4-4 Assign Sounder Group to Device

Allows a Sounder Group to be assigned to a detector. When the detector goes into alarm then the assigned Sounder Group will be activated (Sounder Groups only function when Sounder Configuration is set to PROGRAMMED).

NOTE:

- ***When a fire occurs all the Sounder Group information for the detector in fire is combined: the device Sounder Group is combined with the Zone Sounder Group and the Common Sounder Group. 'P' pulsing will override 'S' silent and 'C' will override 'P' pulsing.***
- ***Do not use this function to assign sounders to Sounder Groups; it will have no effect. Assign sounders to Sounder Groups using function 4-2 Configure Sounder Groups.***

4-5 Inhibit Sounders for Device

Allows a device to be set so that it does not operate certain Sounder Groups. (Sounder Groups only function when Sounder Configuration is set to PROGRAMMED).

The options are:

COMMON - The Common Sounder Group (512) is not activated when the device detects fire.

ZONAL - The Zone Sounder Group for the device is not activated when the device detects fire.

ALL - No sounders are activated when the device detects fire.

Inhibiting all sounders for a device will inhibit all sounders, even if the Sounder Configuration is set to PRESET.

COMMON or ZONAL inhibits will not inhibit the Sounder Group directly assigned to a device (function 4-4 Assign Sounder Group to Device) if that device detects fire.

4-6 Sounder Delay Set-up

Allows the sounder delay to be set-up:

The sounder delay can be set to GLOBAL MODE, ZONAL MODE or DISABLED.

The sounder delay period is defined (to a maximum of 10 minutes).

The devices that initiate a delayed sounder activation are specified.

If the function is set to ZONAL MODE it is also necessary to set up the activation using Function 3-5 Zone Sounder Delay Set-up.

The options for initiation are:

CALL POINTS ONLY - call-points start the delay timer. The sounder groups associated with the activated call-point will be queued for delayed activation. Other devices will not start the delay timer and will activate their sounder groups immediately.

DETECTORS ONLY - detectors start the delay timer. The sounder groups associated with the activated detector will be queued for delayed activation. Call points will not start the delay timer and will activate their sounder groups immediately.

ANY DEVICE - any device will start the delay timer. The sounder groups associated with the activated device will be queued for delayed activation. For sounder delays to operate the front panel, ACTIVE DELAYS LED has to be lit. There is only one sounder delay timer, so when this expires any further sounder activations will be immediate.

If SOUNDERS ACTIVATE/SILENCE is pressed when there are sounders queued for delayed activation the queued sounders are also silenced (stopped from sounding). Once the first alarm has been silenced by pressing SOUNDERS ACTIVATE/SILENCE, all subsequent fires will be reported immediately (the sounder delay settings will be ignored).

NOTE: Specific sounders (function 4-7) and specific detectors (function 6-1-6) can be set to override this delay.

4-7 Override Sounder Delays

Allows specific sounders to activate immediately even if the system has been set with sounder delays active.

0 indicates normal operation

X indicates that the specific sounder will operate immediately

Sounders set to immediate will also override any Sounder Group settings for that specific sounder. Sounders set to immediate operation will sound continuously (pulsing settings will be overridden).

5 Input/Output - Disable & Assign

Input/Output Analogue Loop device management.

5-1 Configure I/O Groups

Allows an I/O Group to be established. The I/O Group can then be used for fire or fault reporting. 512 I/O Groups can be defined.

First select the Group number then assign the I/O loop addresses. Each I/O Group can have up to 32 I/O units. (256 for the Common I/O Group)(Group 512). I/O Group 512 is the Common I/O group. The Common I/O Group is always activated when a fire occurs. When a fire occurs all the I/O information for the detector in fire is combined: the device I/O Group is combined with the Common I/O Group and the four 'first fire' Zone I/O Groups.

When a subsequent fire occurs in the same Zone the 'second fire' Zone I/O group is activated.

Upon a fire the I/O operations are cumulative.

NOTE: Specific devices can be set not to activate I/O (including Common I/O) - function 5-4 Inhibit I/O for Device.

5-2 Select Fault I/O Group

Allows a specified I/O group to be activated if a fault condition occurs.

It is not recommended to use the same I/O group for fire and fault reporting.

5-3 Assign I/O Group to Device

Allows an I/O Group to be assigned to a detector.

When the detector goes into alarm then the assigned I/O Group will be activated.

NOTE: When a fire occurs all the I/O information for the detector in fire is combined: the device I/O Group is combined with the Common I/O Group and the four 'first fire' Zone I/O Groups.

This function can be used to assign an I/O module (input) to activate an I/O Group output. The I/O Group output could be on the same I/O module, another I/O module or a group of I/O modules.

5-4 Inhibit I/O for Device

Allows a device to be set so that it does not operate certain I/O Groups.

The options are:

COMMON The Common I/O Group (512) is not activated when the device detects fire

ZONAL The Zone I/O Group for the device is not activated when the device detects fire

ALL No I/O Groups are activated when the device detects fire

COMMON or ZONAL inhibits will not inhibit the I/O Group directly assigned to a device (function 5-3 Assign I/O Group to Device) if that device detects fire.

5-5 I/O Unit Action upon Evacuate

Allows you to define how an I/O module will perform when an evacuate is signaled. By default an I/O module will not activate unless it has been assigned to an I/O Group than has been activated.

NOTE: An evacuate is not considered as an automatically detected fire event.

5-6 I/O Unit Delay or Immediate

Allows a specific I/O module to be set, so that it activates immediately even if the rest of the I/O is set to be activated after a delay.

5-7 I/O Delay Set-up

Allows the I/O (output) delay to be set. This delay applies to all I/O module outputs.

The maximum delay that is allowed is 10 minutes.

There is only one I/O timer so once it has expired events activating further delayed I/O groups will cause immediate I/O operation.

NOTE:

- **Delays will only occur if front panel ACTIVE DELAYS button has been set to on.**
- **Specific I/O modules (function 5-6) and specific detectors (function 6-1-6) can be set to override this delay.**

5-8 Select Disable I/O Group

Allows a specific disablement I/O group to be activated per zone.

5-9 Configure Remote Inputs

Allows the user to configure the remote inputs behaviour REM1 and REM2. Each remote input can be configured with the following options:

EVACUATION

DISABLE SELECTED DETECTORS

USER ACCESS

RESET

6 Device Set-up

Allows specific settings to be selected for individual Analogue Loop devices.

6-1 General

Settings common to all types of Analogue Loop devices.

6-1-1 Disable Loops

Allows a specific Analogue Loop to be disabled or enabled. The default is enabled.

All devices on the disabled loop will cease to operate with the exception of the (audible) output from loop sounders.

If the loop is disabled it will be indicated when programming mode is exited. It can be reviewed using the DISABLED (QUEUE REVIEW) button.

6-1-2 Device Disable

Allows a specific device to be disabled or enabled. The default is enabled.

Disabled devices have both inputs and outputs disabled.

This function does not disable the (audible) output from loop sounders.

Any devices that are disabled will also be indicated when programming mode is exited. They can then be reviewed using the DISABLED (QUEUE REVIEW) button.

6-1-3 Set Selective Disablement

Allows a specific device to be set up for selective disablement.

The device is only disabled when the SELECTED DETECTORS (DISABLEMENTS) button on the front panel is activated.

This function is intended for use when certain detectors regularly need disabling but are not necessarily in the same Zone.

Outside programming mode any devices that are currently disabled can then be reviewed using the DISABLED (QUEUE REVIEW) button.

6-1-4 Set Device Reporting Details

Each device can be set to: FIRE; FAULT; PRE-ALARM; TRANSPARENT.

The default is FIRE reporting.

When the device is activated or reaches its alarm threshold, then the event is reported in accordance with this setting.

FAULT - Primarily intended for use with Input modules, it can allow activation of one input to trigger a fault report rather than a fire.

PRE-ALARM - Sends warning when the level reported from a detector is 10 below the Alarm threshold. Used for early warning in sensitive applications.

TRANSPARENT Configuration is ONLY applied to Input/Output or Input units. It is not compliant to EN54.

6-1-5 Set Immediate Evacuate for Device

When a detector set to immediately evacuate reports a fire, all Sounder Group settings are ignored. All sounders are operated immediately as if the Sounder Configuration was set to PRESET and all delays are ignored.

6-1-6 Device Activation Overrides Delays

Allows a detector to be set to override all zonal and global sounder and I/O delay timers. When this device is activated the Sounder Groups and I/O Groups associated with this device are also activated immediately (even if they were already queued for delayed activation).

However this device will not start any of the timers either, which means that subsequent fires reported from other detectors may experience the full delay duration (as programmed).

6-1-7 Inhibit Auxiliary Relays

Allows a specific detector to be set to not operate system I/O's and Auxiliary Relays when it reports a fire (Equivalent to pressing auxiliary relays disablement button).

6-1-8 Global Behaviour Set-up

This function selects the Behaviour of all the detectors that have been set to GLOBAL.

Different settings can be entered for weekdays and for Saturday and Sunday.

Settings are:

- Smoke only
- Smoke / Heat
- Heat only
- TIMED

If TIMED is selected then the night and day behaviour settings used based on whether it is night or day.

Set the night and day behaviour using the programming function 6-1-9. Define the start time of day and night using programming function 8-1-2.

The Pre-alarm levels are always 10 below the alarm thresholds.

Ensure that the system clock, date and time are set correctly (function 8-1-1).

Note that in order to keep day/night and day settings consistent, a day setting starts at sunrise (which is set by function 8-1-2). This means that, for example, the Saturday setting will start at 8:00 AM on Saturday.

6-1-9 Configure Timed Behaviour

Allows the Behaviour to be set for day and night.

Settings are:

- Smoke only
- Smoke / Heat
- Heat only

NOTE: Only detectors that have their Behaviour selected will have their settings changed, and only if 6-1-8 Global Behaviour Set-up has been set to TIMED.

6-3 Device Specific - Functions only available for panels programmed to ZEOS Protocol

Analogue Loop device settings that are specific to devices that support the ZEOS communication protocol.

6-3-1 Select Device Behaviour Mode

Allows a specific operating mode to be selected for a specific device. Refer to the device manual for the mode definitions.

The modes usually relate to sensitivity or detection methods.

Settings are:

- Smoke only
- Smoke / Heat
- Heat only
- GLOBAL

If GLOBAL is selected then, depending on the day, the appropriate Smoke Only, Smoke / Heat, Heat only setting is used (see functions 6-1-8 Global Behaviour Set-up and 6-1-9 Configure Timed Behaviour).

6-3-2 Flashing LEDs On/Off

When set to FLASHING, all ZEOS devices on the system will flash their LEDs when they are polled. Only ZEOS devices that have had the flash disabled will not flash when polled (see programming function 6-3-3).

NOTE: When this setting is changed it is necessary to write individually to every ZEOS device connected to the system. This can take 60 seconds. During this time do not select any ZEOS specific programming functions (6-3-X).

6-3-3 Disable Specific Flashing LEDs

Use this function to individually disable the LED flash when polled on ZEOS detectors.

This setting has no effect when programming function 6-3-2 'Flashing LEDs ON/OFF' is set to OFF.

6-3-4 Re-calibrate ALL Devices

Function that sends a write command to all devices to trigger detectors re-calibration.

6-3-5 Check for Devices Needing Service

When activated, this function reads the drift compensation value of every ZEOS device connected to the system.

Any devices that are close to their drift compensation limit (and therefore will shortly be in need of servicing) are

reported via the normal fault reporting mechanism. These 'FAULTS' will have the message 'DEVICE NEEDS SERVICE'. They can be reviewed once programming mode has been exited. Because they are reported as 'FAULTS' they are recorded in the event log and can therefore be reviewed and printed out using programming functions 1-1 and 1-2.

NOTE: When this function is activated it is necessary to read from every ZEOS device connected to the system. This can take 60 seconds. During this time, do not select any Discovery™ Specific programming functions (6-3-X).

6-3-6 Read Data Stored in Device

Allows any of the data bytes stored in any ZEOS device connected to the system to be read.

The byte read is displayed in decimal.

Readings will only be attempted on sub-panels that are set for ZEOS detectors.

If the chosen device is not a ZEOS device, an error will be reported (this error is not logged).

6-3-7 Write Data Stored in Device

Allows a decimal value to be written to any of the four 8-bit user data locations in any ZEOS device connected to the system starting at address 11. The values that can be inserted must lie within the range 0-255, otherwise it will cause an overflow of the byte value.

Writes will only be attempted on panels that are set for ZEOS detectors.

If the chosen device is not a ZEOS device, an error will be reported (this error is not logged).

One sample application for this capability would be to record in each ZEOS compatible device the installation date (month/year). Using one byte for the month and another for the year. Another one would be to insert a code or reference for the installation.

6-3-8 Select Device Smoke Sensitivity

This function is only suitable for smoke detectors.

It allows the alarm threshold for smoke detectors to be set.

Each individual detector has the following settings:

HIGH = 45

NORMAL = 55

LOW = 65

6-3-9 Select Device Heat Grade

This function is only applicable to Heat Detectors. It has no effect on other devices.

It allows the alarm threshold for the heat detector to be set.

The default threshold is 55°C.

The Pre-alarm levels are always 10°C below the alarm thresholds.

6-4 Automatic Address Setting (ASET)

Introduction

Automatic Address Setting (ASET) is a special install and commissioning mode that can be activated on a per loop basis whilst in INSTALLATION mode. ASET mode is only required if Auto-address devices are used in the fire protection system. Auto-address devices do not have their addresses set using switches. They automatically assign their own addresses and ASET mode is used to achieve this.

Because ASET mode requires manual triggering of each device (using the standard test procedure for each one) the installer can effectively choose the address for each detector and simultaneously program and test each device.

Automatic Addressing Devices CAN BE MIXED WITH OTHER TYPES OF DEVICES ON THE SAME LOOP. Each time an Auto-address-device is programmed it takes the next free address on its loop.

General Guidelines

Before starting the programming procedure, care should be taken with the following:

- a) Supply OK.
- b) Auxiliary Supply (Batteries) OK.
- c) Loop Supply OK.
- d) Verify the non-existence of earth current leakage.
- e) Verify the cable lengths for the loop.
- f) Confirm the non-existence of short or open circuits within the loop.
- g) Verify communications with standard analogue addressable devices is OK.
- h) Verify communications between Panel and Repeaters.

Verify that all Automatic Addressing Devices connections, both to the loop and the associated device (i.e. smoke sensor/detector, call point, etc.) are properly made and that the device connections follow the manufacturer's instructions, in particular those regarding polarity. Reversal of the supply polarity can cause failure or malfunction and prevent an Automatic Addressing Devices from being programmed.

CAUTION

**Verify that there are no faults or fire conditions in the loop or system.
Clear all faults and fire conditions first.
Reset to normal operation all devices before applying power to the panel,
in particular manual call points.**

6-4-1 Activate ASET Mode (Automatic Address Settings)

The enabling of this mode is done on a per loop basis.

When the loop is in ASET MODE, the TEST LED on the Panel will be ON.

CAUTION

A loop while in ASET mode will not offer any kind of protection against fire conditions.

DO NOT remove or replace auto-address-devices while loop is powered. If one of these modules has to be replaced or removed, first disconnect all supply sources to the panel.

CAUTION

Removal of an auto-address-device while loop is powered can corrupt programming of this module.

Start auto-address-devices programming

Activate a blank auto-address-device by either testing the device associated with it, either using the standard test procedure for the device. Smoke and heat detectors will have their alarm LED permanently lit when activated. Sounders can be set to activate for approximately 1 second using function 7-3, every time a new auto-address-device is activated (i.e. fire condition). The programming of a new address can be monitored **using function 7-1**, after a new auto-address-device has been programmed the device count will increase by one and by selecting the newly programmed address, the device type, address and analogue value can also be confirmed.

NOTE: A programmed auto-address-device that has been RESET and re-enters the fire condition will force the panel to activate the sounders without a new address being programmed. The panel will activate the bells/sounders every time there is a new fire condition, regardless of it being caused by a new address being attributed or not. Each new auto-address-device programming should be confirmed and monitored, in order to avoid misleading information originating from auto-address-devices that have already been programmed.

This procedure is then repeated for each blank auto-address-device on the loop. There should be a time interval of approx. 10 seconds between auto-address-device activations.

NOTE: If two auto-address-devices are simultaneously activated, neither will be programmed with an address. One auto-address-device must be activated (and programmed) at a time. Physically removing any device on a loop in ASET mode will free up the device address and the next auto-address-device to be activated could potentially be assigned that address.

Two functions are provided to the installer, should the need arise to clear/ erase any or all auto-address-devices modules in a specific loop:

Function 6-4-2 Clear Loop

Use this function to clear/ erase all auto-address-devices on the specified loop.

Once erased, all auto-address-devices on that loop must be reprogrammed using ASET mode. See function 6.4.1.

Function 6-4-3 Clear Device

Use this function to erase a single auto-address-device on a specific loop.

NOTE: Both functions 6-4-2 and 6-4-3 will operate even if the chosen loop is not in ASET mode.

After all auto-address-devices have been programmed in a loop, perform a MASTER RESET to the panel followed by a confirmation, using function 7.1, that all devices have been correctly programmed (i.e. device address, type and analogue value).

**UPON COMPLETION OF THE INSTALLATION AND COMMISSIONING STAGES,
A FIRE DETECTION SYSTEM SHOULD ALWAYS OPERATE IN ACTIVE MODE.**

TROUBLESHOOTING

Applicable for Function 6-4 only

a) Auto-address-device does not program

If during the course of programming an auto-address-device, the new address is not programmed in the module, verify that the connections to both the loop and the device are correctly made. Confirm supply polarity of the device. Always follow manufacturer's instructions. Check loop voltage at the auto-address-device terminals followed by a verification of the device voltage, measure voltage across the supply wires (black & red). In normal operation it should always be greater than 17V DC. Verify the condition of the whole system, in particular supplies (auxiliary and loop), earth leakage, loop length too long, loop with a short or open circuit and panel communications. If all of these are OK, then do a system reset after which you should verify, using function 7-1, if there are devices with duplicated address. If there are, clear those addresses and reprogram auto-address-devices that previously had identical addresses.

In the eventuality that one auto-address-devices does not program but there is no evidence of two devices having identical addresses after a system reset has been performed, clear the last programmed address using function 6-4-3 and reprogram auto-address-devices. If that does not solve the problem, replace the auto-address-devices module. Remember that a duplicate address fault will only show with ASET mode disabled.

b) Auto-address-devices with duplicate addresses

In an installation with auto-address-device, should there be a fault of 2 devices or more with the same address (duplicate address fault) two actions can be taken:

- 1) CLEAR LOOP. Clear the loop where some auto-address-devices have duplicate addresses. See function 6.4.2. This action should only be applied when in a brand new installation, where all auto-address-devices should have been blank (no address programmed).
- 2) Alternatively the duplicated address can be erased using function 6.4.3.

Reset the panel and verify, using function 7.1, the offending address and henceforth the associated FAULT condition has disappeared. Re-program cleared devices. Repeat the procedure until the fault disappears. If after the third time the address clearing procedure has been repeated the fault persists, replace those auto-address-devices that have duplicate addresses. It should be observed that this verification can only be performed when ASET mode is disabled, since the fault condition where 2 devices have the same address is not shown when in this particular mode.

7 Monitor Device Counts & Test

7-1 Device Count, Type & Value

Use this function to check that all loop devices are present.

Use ▲ ▼ to select the device address on that loop.

Use ► to select the panel Loop.

This function is also useful to confirm the address of the various different types of devices connected to the Analogue Loop.

Note that in Installation Mode all information is live, i.e. the count of devices will change as the panel learns and device types will be updated if they change. In Active Mode only the device value is live.

7-2 Test Sounders

Use this function to test the audibility of the sounders in a more comfortable manner than pressing SOUNDERS ACTIVATE/SILENCE. The Panel Conventional Sounders will sound for 1 second and then be silenced for 9 seconds.

7-3 Sounders on Test Activation

This function allows you to choose an audible confirmation that a device has detected a fire. The audible confirmation consists of a 1 second period of sounder operation. The settings selected by this function are used by '7-4 Test Zones' and '6-4-1 Activate ASET Mode (Automatic Address Settings)'.

ALL SOUNDERS ON DETECTOR TEST activates the Panel Conventional Sounders and Loop Sounders.

NOTE: Using this function AFTER '7-4 Test Zones' and '6-4-1 Activate ASET Mode (SAM)' will NOT change the settings for the zones already in test mode and the loops already in ASET mode.

7-4 Test Zones

Select the Zones you wish to put into test mode.

Exit programming mode, but DO NOT press SYSTEM RESET as this clears all test modes.

In test mode, when a detector is activated the LED on the detector will be ON and the event will be reported on the Panel (and Repeaters) for 15 seconds. If selected then the sounders will also operate for 1 second. The LED on the detector is not latched and will clear when the alarm level falls below the alarm threshold for the device.

Pressing TEST QUEUE REVIEW will report the zones that are in Test Mode.

7-6 Light LED on device

This function can be used to confirm the physical location of a specific detector. Select the device and SWITCHED ON and press ENTER. The device will typically take a few seconds to respond. LEDs stay "ON" until reset is pressed. Output device relay will change state if "LED ON" is selected.

8 General

8-1 Time/Date & Timers

8-1-1 Set Date & Time

Allows the date and time for the system to be set. The date and time are displayed on the LCD whilst the system is not in fault nor fire.

Press ENTER to skip an entry and after each entry.

It is important to set the date and time, because it is used in the event logging and may also be used to change the detector sensitivities or to disable delays at night.

There is only one clock in the system. Setting the date and time at a Repeater is actually setting the SYSTEM clock.

NOTE: Removing panel power completely will erase date and time information from panel. Verify that correct date and time information is present after finishing panel commissioning or whenever timestamp is relevant (ex: device activation testing).

8-1-2 Define Day & Night

Defines sunrise and sunset for the system.

The system considers a day to start at sunrise. So when different detector sensitivities are set for different days (function 6-1-8) the new day will start at the sunrise time defined here. If different sensitivities have been set for day and night (function 6-1-9) then the times defined here are the times the sensitivity change will take place.

If delays have been set to be switched off at night (function 8-1-3), then this will happen at the sunset time defined here.

8-1-3 Delays Off at Night

This function allows the delays for Sounders and I/O activation to be overridden at night.

There are two options: OFF and UNAFFECTED.

UNAFFECTED means that the system settings will remain the same at night as they are during the day.

OFF means that at night time the Sounder, I/O module and Fire Brigade Transmission delays are all turned off and the outputs will activate immediately if a fire is detected.

This function has exactly the same effect as using the ACTIVE DELAYS button on the front panel to disable the delays at sunset, then using the same button to restore the day setting at sunrise.

Sunrise and sunset are defined using function 8-1-2.

8-1-4 Configure Evacuate Timer

Allows the evacuation timer to be enabled and the duration of the timer to be set.

The evacuation timer runs in parallel to all other events. Once triggered it starts counting down, when it expires all sounders are activated. This means various sounder groups may be activated in the meantime (and even silenced) but when the evacuate timer expires all sounders not sounding are activated.

10 minutes is the maximum duration.

The Evacuate Timer can be set to:

- DISABLED
- DEVICE MODE
- GLOBAL MODE

In **DEVICE MODE** the evacuate timer is started when a device that has been configured to start the Evacuate Timer detects a fire. In **GLOBAL MODE** the Evacuate Timer is started when any device detects a fire.

NOTE: For DEVICE MODE to work at least one device must be set to start the timer. See programming function 8-1-5. Once started, the evacuate timer is not stopped by pressing ALARM SILENCE, although ALARM SILENCE will still silence the sounders once they have been activated. Disabled sounders are never activated by the evacuate timer.

8-1-5 Device Starts Evacuate Timer

Allows you to specify which detectors will start the Evacuate Timer.

The Evacuate Timer must be in DEVICE MODE to be activated by specific devices. See programming function 8-1-4.

8-1-6 Enable / Disable Delays

This function allows the user to configure the DELAYS ACTIVE key behaviour.

The DELAY ACTIVE can be pre configured as:

- BUTTON (allow button to be pressed ON/OFF)
- ACTIVE (always ON)
- INACTIVE (always OFF)

8-1-7 Configure Extended Delays

This functionality enables the possibility of having a 2nd stage delayed operation of programmed Sounders and I/O's in a way that after acknowledgement of reported alarm before 1st stage, programmed delays are extended so that a local inspection can take place.

- Extended delay 'time of inspection' delay is programmed.
- "Time of acknowledgement" delay is normally configured to sounders, I/O's or both in functions 4-6 and/or 5-7.
- In case of a Fire Alarm, if the "Alarm Silence" key is not pressed before 1st stage delay is elapsed, programmed sounders and I/O's will be activated.
- If "Alarm Silence" is pressed within the 1st stage timer, 2nd stage delay starts. Alarm silence key LED blinks while the delay is running until time is elapsed (activation) or a second press of "Alarm Silence" key.
- If the "Alarm Silence" key is pressed a second timer, sounder activation is canceled but programmed I/O's will be activated.
- I/O's activation is only canceled with panel reset.

8-1-8 Configure Disablement Timer

This menu configures a timer to automatically re-enable all disablements after a selected time. It will show the running timer countdown after a disablement has been set. To extend the countdown timer press the ► key.

NOTE: The "Selective Disablements" are not affected by this.

8-2 Special Features Set-up

Programming functions associated with the system response and detection of a fire.

8-2-1 Two Devices to Evacuate

Enables or disables a system wide setting so that detection of fire by two detectors automatically starts evacuation. Evacuation means any Sounder Group settings will be ignored and all sounders will be operated immediately.

8-2-2 Call Points to Evacuate

Enables or disables a system wide setting so that a report of fire from a call-point automatically starts evacuation. Evacuation means any Sounder Group settings will be ignored and all sounders will be operated immediately.

8-3 Memory - BEWARE, ENGINEERS ONLY

Programming functions that are associated with management of the Panel memory.

There are three main memory sections on the panel. The following table shows an overview on the most relevant data per memory section.

<i>CUSTOMER FLASH "System Cause-Effect"</i>	<i>NVRAM "local memory"</i>	<i>"ONLINE" DEVICES DATA (cleared upon reset)</i>
access codes	mem. checksums	Device Analog Value per Loop
global config	delays activation	Device Type Value per loop
specific device config	dev. disable	Fault activation
sounders groups config	zone disable	Fire activation
io groups config	sounder disable	Evacuation activation
zone config	network panel address	Test mode activation
selective device disab.	operation mode (active/inst.)	-
delays and timers config	bms address	-
-	network management data	-
-	log events and auto reset count	-
-	local faults	-

8-3-1 Checksums

This function displays the current calculated checksum between processor and Non-Volatile-Ram.

8-3-2 Clear Non-Volatile RAM

Clearing the NVRAM clears all the installation settings and the system is automatically put into Installation Mode.

On the Panel this will result in:

- The Analogue Loop will be enabled
- All disabled Zones will be enabled
- All disabled devices will be enabled
- All disabled sounders will be enabled
- The event log will be cleared, only if using master code. The user/installer code will not clear the LOG.
- The auto-reset count will be cleared
- Information on fitted devices and their types will be cleared
- All checksums will be cleared and recalculated.

After clearing the NVRAM it is essential to perform a system Master Reset.

8-3-3 Calculate Customer Flash Checksum

Calculates and stores the checksum for all the data in the customer Flash memory.

When settings are changed using the programming functions, this checksum will be re-calculated as required. Downloads of customer data also result in an automatic update of the checksum.

This stored checksum is regularly (approximately every 2 minutes) compared with a freshly calculated checksum, to check for memory corruption.

8-3-4 Calculate Program Flash Checksum

Unlikely to be required in normal circumstances, this function calculates and stores a checksum for the program Flash memory. Software upgrades are downloaded automatically resulting in a new checksum being calculated and stored.

This stored checksum is regularly (approximately every minute) compared with a freshly calculated checksum to check for memory corruption.

8-3-5 Clear Customer Flash Memory

This function will erase all customers configuration (cause-effect programming) stored in panel.

All selective disablements defined on “**6-1-3 Set Selective Disablement**” will be cleared.

8-4 Other Features

These are programming functions that do not fall into any other category.

8-4-1 Active/Installation Mode

An essential function. The system should always be left in ACTIVE mode, unless the system is being installed and debugged. When the system is set to Installation Mode the green SYSTEM ON LED on the front panel of the Panel and Repeaters will flash.

Whilst in Installation Mode the system will automatically detect and record the presence of all connected devices.

To install the system first ensure all detectors, sounders and modules are connected and have power. Next select Installation Mode using this function, exit programming mode and press SYSTEM RESET.

Once the system has been in Installation Mode for 90 seconds then the system can be put into Active Mode.

Note that there is no clear end to Installation mode because the system is constantly looking and learning. However if the system is put into Active Mode and Installation Mode hasn't had time to identify all system components, you will very quickly be greeted with error reports regarding the presence of unexpected devices.

If devices are ever removed, replaced or added then Installation Mode must be selected so that the system can learn the new configuration. If you do not do this, the system will report a fault.

8-4-4 Set User Access Code

This function allows the installer to change the customer Access Code. Use ► ▲ ▼ to change code sequence.

8-4-5 Set User Functions

Allows the user access level to be set for every programming function.

Settings are: NONE - READ ONLY - FULL ACCESS

Do not set 8-4-5 Set User Functions to FULL ACCESS or the user will be able to enable all the other functions!

It is not appropriate to set some functions to READ ONLY - for example “8-3-4 Calculate Program Flash Checksum”.

The default setting for all programming functions is NONE.

8-4-6 Select language

Allows the language setting for the system to be set.

Do this carefully, you will need to navigate back to this function to change it back again.

All text in the system will be changed to use the selected language. The change will take effect when ENTER is pressed.

8-4-8 Set Installer Access Code

This function allows changing the Installer Code without requiring knowledge of the Factory Code. Display will show:

ENTER PRESENT CODE

ENTER NEW CODE

CONFIRM NEW CODE

8-4-9 Set Master Access Code

This function allows changing the Master Code without requiring knowledge of the Factory Code. Display will show:

ENTER NEW CODE

CONFIRM NEW CODE

8-5 Network Configuration

All related with Network configurations and Network Protocols

8-5-1 Configure Panel Number

This function allows changing the Panel Network Number (address). This should be unique in the network.

NOTE: *The Chameleon Rep will need to set an unique Panel Network Number*

8-5-2 Known Panels

This function will show how many panels are being recognized and all panel network addresses detected. It will also indicate its own Address on the network.

NOTE: *This function will only show the panels that are being listened to (RX). Meaning that this will only evaluate the receiving transmission path. For further troubleshoot info, please refer to the Chameleon Communications manual.*

8-5-3 Installation Status

This function will show the status of the network and error messages. Example: "No nodes detected".

8-5-4 Broadcast Configuration

This function will send the local configuration to all panels in the system.

NOTE:

- **Before running this configuration, ensure that the latest configuration is already uploaded into this panel.**
- **Before running this function, please go to each panel in the network and run on each one the 8-5-2 menu and verify that all panels are "seeing" each other and there are no communication issues.**
- **Do not unplug the power during Broadcast.**
- **Do not run this function if you have network issues.**
- **Ensure that the firmware is the same in all panels.**

8-5-5 Communication Channels

This function shows in which channels data is being received. If the panel has previously received data on a specific channel and no longer listens to messages, meaning that the channel lost the receiving data, then it will signal (ERR).

NOTE: *Chameleon Communications troubleshooting and menus are mostly focused from the "listening/receiving" path. Most of the communications faults are detected by a loss on the receiving channel.*

8-5-6 BMS Setup

This function will configure all Building Management System (BMS) Protocols available. The programmable channels in the GEKKO are CH1 & CH2. BMS Protocols can be individually programmed per channel.

The Chameleon Panels support the following BMS configuration in each of the CHANNELS:

BMS PANEL ADDRESS	PROTOCOL SELECTION	TYPE SPECIFIC	comments
XX (not applied)	NONE	(not applied)	working as a normal Chameleon port
XX (not applied)	UI	(not applied)	working with MIMIC module or CHAMELEON DISPLAY
XX (not applied)	PRINTER	(not applied)	Working with external PRINTER
01-64	MODBUS-RTU	(not applied)	working as an MODBUS port => with the specified PANEL ADDRESS
01 to 64	ODYSSEY	(not applied)	working as an Odyssey port => with the specified PANEL ADDRESS
XX (not applied)	SHORT MSG	1	working as "short text" serial port => DECT, no fault ('B'-Alarm / 'V'-PreAlarm)
		2	working as "short text" serial port => DECT, transmit faults ('B'-Alarm / 'V'-PreAlarm / F-Faults)
		3	working as "short text" serial port => SafeTel, no faults ('Al'-Alarm / 'Fo'-PreAlarm)
		4	working as "short text" serial port => SafeTel, transmit faults ('Al'-Alarm / 'Fo'-PreAlarm / 'De'-Device Faults / 'Sy'-System Faults)

8-9 Version Information

This function allows the installer to check which software version is running on the current Panel.

TECHNICAL SPECIFICATIONS

Please note that these specifications apply to the GEKKO Analogue Addressable panel, 1 to 4 loop models, equipped with a 2.4 A power supply @ 28.5V DC nominal.

TECHNICAL SPECIFICATIONS	
POWER SUPPLY AND CHARGER	
PRIMARY SUPPLY	90V to 253V @ 50 Hz 65 W
MAINS ELECTRICAL FUSE	4A - Surge protected (slow blow) 20mm HRC
DC OUTPUT VOLTAGE	28,5V DC
BATTERY CHARGER OUTPUT	27,5V DC nominal @ 20°C
SECONDARY SUPPLY	24V sealed lead acid batteries Maximum capacity 2x 12V 7AH Deep Box: for larger volume batteries Both fitted internally Min. Voltage 21,7V DC (Vb min) Max. Voltage 27,2V DC Max. Current Output 1.85Amp Battery Fuse 1.85A - Resettable Electronic Fuse Maximum Internal Resistance 1 Ohm
POWER SUPPLY RATING	2.4A @ 28,5V DC nominal, comprising: 1.4A used for internal electronic circuits and external ancillary circuits: A maximum of 150mA is available for each loop power. Maximum of 65mA for internal electronic circuits. 300mA for auxiliary power supply outputs. Under alarm conditions a maximum of 500mA current available for conventional sounder circuits.
CONTROL AND INDICATING EQUIPMENT SPECIFICATIONS	Primary addressable detection and alarm circuit 28.5V DC Sounders conventional output circuit 28V DC
POWER BUDGET QUIESCENT CONDITION	a - 64mA internal circuits b - 300mA auxiliary supply outputs c - 660mA (4x165mA) for analogue loop power d - 1A for battery charger
ALARM CONDITION	500mA for conventional sounder circuits +a+b+c
AUX. POWER OUTPUT	28V DC 300mA
MAX. RIPPLE VOLTAGE	400mV peak-to-peak @ Maximum output loading
SENSOR / LOOP CIRCUITS	Max. number of devices per loop: 250 (125 individually addressed) Supports analogue addressable devices over a 2 wire combined power and digital data transmission loop Maximum Loop current: 165mA Loop short circuit (trip) current: 900mA Maximum recommended loop length is 1.2km with 1.5mm ² wire cross-section Maximum cable capacitance: 120pF/m Minimum cable cross-section: 0.5mm ² Maximum cable cross-section: 1.5mm ²
CONVENTIONAL SOUNDER CIRCUITS	2 individually programmed. Both circuits current limited and monitored for both open and short circuit fault conditions. 10k Ohm E.O.L. resistors are used. Maximum current rating per circuit 250mA.

AUXILIARY RELAY OUTPUTS	2 voltage free changeover relay outputs used for fire indication. 1 voltage free relay output for fault indication. Remains energized (normally closed) under normal condition and de-energized when any fault condition appears on the system. Maximum current rating for each relay contact 2A @ 30V DC resistive / 0.5A @ 120V AC resistive / 0.25A @ 240V AC resistive.
OPERATING TEMPERATURE	-10°C to + 50°C
RELATIVE HUMIDITY	85% (non-condensing)
DIMENSIONS	273 (W) x 404 (H) x 107 (D) mm
WEIGHT	Empty: 1.6Kg / Including sealed lead acid batteries: 2 x 12V 7AH - 7.0Kg
REPEATER	
SUPPLY VOLTAGE	24V DC nominal
QUIESCENT CURRENT MAX.	65 mA
DIMENSIONS	255 (W) x 200 (H) x 70 (D) mm

WARNING:

In case of a short circuit or interruption of the analogue detection loop, only a maximum of 32 detectors or call points (per loop) can be prevented, at any given time, of transmitting a fire alarm. In order to assure compliance with EN54-2 clause 12.5.2 loop isolators have to be installed every 32 devices in the loop.

EN54-13 SPECIFICATIONS

Devices with EN54-13 approval

Family	Product Description	CPR
Sounders	VALKYRIE ASBI, ASB, ASI, AS	1328-CPR-0286
	VALKYRIE CSB, CS	1328-CPR-0287
	VULCAN 2 ASBI, ASB, ASI, AS	1328-CPR-0288
	VULCAN 2 CSB, CS	1328-CPR-0289
	VALKYRIE ASBI IP65, ASI IP65	1328-CPR-0299
	VALKYRIE CSB IP65, CS IP65	1328-CPR-0300
Manual Call Points	GFE-MCPE-C-IP67	1328-CPR-0373
	GFE-MCPE-A	1328-CPR-0374
	GFE-MCPE-AI	1328-CPR-0375
	GFE-MCPE-AI-IP67	1328-CPR-0376
	GFE-MCPE-C	1328-CPR-0377
Detectors	ZEOS-AD-SHI	1328-CPR-0492
	ZEOS-AD-H	1328-CPR-0520
	ZEOS-AD-S	1328-CPR-0521
	ZEOS-AS-SHI	1328-CPR-0524
	ZEOS-AS-SH	1328-CPR-0525
	ZEOS-AS-S	1328-CPR-0526
	ZEOS-AS-H	1328-CPR-0527
	ZEOS-AD-SI	1328-CPR-0607
	ZEOS-AS-HI	1328-CPR-0608
	ZEOS-AS-SI	1328-CPR-0609
	ZEOS-AD-HI	1328-CPR-0610
	PSE	ORION-BCM
Short-Circuit Isolator	GFE-AD-ISO	1328-CPR-0538
Input-Output Devices	3 I/O Plus - 1 Channel	1328-CPR-0542
	3 I/O Plus - 2 Channel	1328-CPR-0543
	3 I/O Plus - 3 Channel	1328-CPR-0544
	Mains I/O	1328-CPR-0545
	QUAD-ZMU 1Z	1328-CPR-0575
	QUAD-ZMU 4Z	1328-CPR-0577
	QUAD-ZMU 3Z	1328-CPR-0578
QUAD-ZMU 2Z	1328-CPR-0579	
Fire Panels	GEKKO 1Loop, 2Loops, 3 Loops 4 Loops	1328-CPR-0737

Technical and System Information for EN54-13 Compliance

GEKKO 1 Loop, 2 Loops, 3 Loops and 4 Loops

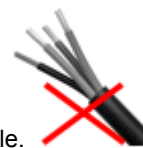

- It is not allowed to run the loop out and loop return conductors on the same cable.
- It is mandatory the use of class A topology.
- The panel is limited to address a maximum of 125 addressable devices per loop, but sometimes can be less because some devices require multiple addresses (3 I/O PLUS and QUAD ZMU).
- A maximum of 32 addressable sounders can be fitted on each loop.
- A maximum of 20 sounders on conventional sounders output.
- Each loop is limited to draw a current, in nominal operating condition, of 150 mA in quiescent mode.
- Each conventional sounder output is limited to drive a current of 250 mA in fire alarm condition.
- A maximum current of 300 mA can be drawn on the DC Auxiliary Supply Output.

Transmission path	Type	Cable Type	Max. Length	Max. Section	Nominal Electrical specification
AC Mains Power port	Wired, AC Mains Power Input	Mandatory the use of unshielded cable	-	2,5mm ²	90 V to 253 V @ 50Hz
Loop 1 out port	Wired primary addressable detection and alarm circuit	Mandatory the use of shielded cable	1200 m for each loop	1,5mm ²	28,5 V DC / 150 mA
Loop 1 return port					
Loop 2 out port					
Loop 2 return port					
Loop 3 out port					
Loop 3 return port					
Loop 4 out port					
Loop 4 return port					
Sounder 1 port	Wired, primary conventional alarm circuit		500 m for each output		28 V DC / 250 mA
Sounder 2 port					
DC Auxiliary Supply Output	Wired, DC Output	Mandatory the use of unshielded cable	500 m	1,5mm ²	28 V DC / 300 mA

Table 1 - GEKKO 1 Loop, 2 Loops, 3 Loops, 4 Loops, IOs and TPs specifications.

POWER SUPPLY UNIT - ORION BCM

- A maximum current of 300 mA can be drawn on the DC Auxiliary Supply Output.

Transmission path	Type	Cable Type	Max. Length	Max. Section	Nominal Electrical specification
AC Mains Power port	Wired, AC Mains Power Input	Mandatory the use of unshielded cable	-	2,5mm ²	90 V to 253 V @ 50Hz
DC Auxiliary Supply Output	Wired, DC Output		500m	1,5mm ²	27,5 V DC / 300 mA

Table 2 - ORION-BCM, IOs and TPs specifications.

Cabling

- Where shielded cable is required a cable with internal resistance less than 15 Ohm/Km is mandatory.
- Cable shield continuity should be performed inside the device enclosure.

3 I/O PLUS 1/2/3 Channels and MAINS I/O

- For fire condition each input TP shall see a resistance between 2,2 kΩ and 8,2 kΩ.
- For open condition each input TP shall see a resistance higher than 47 kΩ.
- For short circuit condition each input TP shall see a resistance lower than 2,2 kΩ.
- LOOP IN/OUT the limitations of the GEKKO panel are applicable for the same TP.
- The 3 I/O PLUS Output ports are outside of EN54-13 compliance.

Transmission path	Type	Cable Type	Max. Length	Max. Section	Nominal Electrical specification
Loop Input	Wired primary detection circuit	Mandatory the use of shielded cable	-	1,5mm ²	20 V to 30 V from Loop
Loop Output					
Input 1 Input 2 Input 3	Wired secondary input detection circuit	It is not mandatory the use of shielded cable	< 3 m	1,5mm ²	Dry contacts for D type devices
Output 1 Output 2 Output 3	Wired				Dry contacts

Table 3 - 3 I/O PLUS - 3 Channel, IOs and TPs specifications.

Transmission path	Type	Cable Type	Max. Length	Max. Section	Nominal Electrical specification
Loop Input Loop Output	Wired primary detection circuit	Mandatory the use of shielded	-	1,5mm ²	20 V to 30 V from Loop
Input 1	Wired secondary input	It is not mandatory the use of shielded	< 3 m		Dry contacts for D type devices
Output 1	Wired				Dry contacts

Table 4 - MAINS I/O, IOs and TPs specifications.

QUAD ZMU 1/2/3 and 4 Channels

- **LOOP IN/OUT** - the limitations of the GEKKO panel are applicable for the same TP.
- **SUPPLY** - the limitations of the ORION BCM panel are applicable for the same TP.
- **ZONES** - each zone is limited to a number of devices drawing a maximum of 9 mA and fitted with capacitive end of line (EOL) as specified by the manufacturer.
- All shielded cable must be connected.

Transmission path	Type	Cable Type	Max. Length	Max. Section	Nominal Electrical specification
Loop Input Loop Output	Wired primary detection circuit	Mandatory the use of shielded	-	1,5mm ²	20 V to 30 V from Loop
External Power Suply	Wired	Mandatory the use of unshielded cable	Definido pela fonte de alimentação externa		20 V to 30 V from the auxiliary power supply equipment (ORION BCM)
Zone 1 Zone 2 Zone 3 Zone 4	Wired secondary input detection circuit	Mandatory the use of shielded cable	500 m		Up to 9mA



Table 5 - QUAD ZMU, IOs and TPs specifications.

Other Devices

For the remaining devices should be applied the following specifications:

- **LOOP IN / OUT** - the limitations of Table 1 are applicable for the same TP.
- **ZONES IN / OUT** - the limitations of Table 5 are applicable for the same TP.
- **SOUNDERS** - the limitations of Table 1 are applicable for the same TP.

EN54 and CE SPECIFICATIONS

	
Global Fire Equipment SA, Sítio dos Barrabés, Armazém Nave Y Caixa Postal 908-Z 8150-016 São Brás de Alportel 18 1328-CPR-0737	Global Fire Equipment SA, Sítio dos Barrabés, Armazém Nave Y Caixa Postal 908-Z 8150-016 São Brás de Alportel 18 1328-CPR-0737
GEKKO GEKKO 1 Loop, GEKKO 2 Loops, GEKKO 3 Loops, GEKKO 4LOOPS Control and indicating equipment for fire detection and fire alarm systems for buildings EN 54-2:1997/A1:2006	GEKKO GEKKO 1 Loop, GEKKO 2 Loops, GEKKO 3 Loops, GEKKO 4LOOPS Power supply equipment for fire detection and fire alarm systems for buildings EN 54-4:1997/A2:2006
Options Provided This panel complies with the following options with requirement functions 7.9 - Output to fire alarm routing equipment 7.10 - Output to automatic fire protection equipment (Type A,B,C) 7.11 - Delay to Outputs 9.5 - Disabling of addressable points 10 - Test condition	
Other Technical Docs Ref. DoP 537 Ed.1 of 01-04-2019 www.globalfire-equipment.com	

Standard	Title
EN 54-2:1997 + EN 54-2:1997/A1:2006 + EN 54-2:1997/AC:1999	Fire detection and fire alarm systems - Part 2: Control and indicating equipment
EN 50130-4:1995 + EN 50130-4:1995/A1:1998 + EN 50130-4:1995/A2:2003	Alarm systems -- Part 4: Electromagnetic compatibility - Product family standard: Immunity requirements for components of fire, intruder and social alarm systems
EN 54-4:1997 + EN 54-4:1997/AC:1999 + EN 54-4:1997/A1:2002 + EN 54-4:1997/A2:2006	Fire detection and fire alarm systems - Part 4: Power supply equipment.

DECLARATION OF CE CONFORMITY

DECLARATION OF CE CONFORMITY

GFE S.A., manufacturer of addressable fire detection equipment, declares, that the **GEKKO** fire control panel conforms to the following directives of the EEC Commission:

Regulation (EU) n° 305/2011 of European Parliament
and of the 9th March 2011 Council (the Construction Products Regulation or CPR)
EN 54-2:1997 + EN 54-2:1997/A1:2006 + EN 54-2:1997/AC: 1999; EN 54-4:1997 +
EN 54-4:1997/AC: 1999 + EN 54-4:1997/A1:2002 + EN 54-4:1997/A2:2006;
and complies with the following standards:
EN 50130-4:1995 + EN 50130-4:1995/A1:1998 + EN 50130-4:1995/A2:2003;
EN 61000-3-2:2006 (EMC); EN 61000-3-3:2008 (EMC); EN 61000-6-3:2007 (EMC).

We, Global Fire Equipment S.A. hereby declare, for the effects of the requirements laid down with EN54-4 paragraph 6.1, that the power supply equipment included in our analogue addressable fire alarm panel named GEKKO has been designed in accordance with a quality management system which incorporates a set of rules for the design of all elements of the p.s.e., and that its components have been selected for the intended purpose, and expected to operate within their specification when the environmental conditions outside the cabinet comply with class 3k5 EN60721-3-3:1995

We, Global Fire Equipment S.A. hereby declare, for the effects of the requirements laid down with EN 54-2 paragraph 12.1, that the control and indicating equipment which is our analogue addressable fire alarm panel named GEKKO has been designed in accordance with a quality management system which incorporates a set of rules for the design of all elements of the c.i.e. and its components have been selected for the intended purpose, and are expected to operate within their specification when the environmental conditions outside its cabinet comply with class 3k5 EN 6 0721-3-3:1995

We, Global Fire Equipment S.A. hereby declare, for the effects of the requirements laid down with EN-54-4 paragraph 6.3.2, that the power supply equipment included in our analogue addressable fire alarm panel named GEKKO, is in accordance with EN 60950-1:2006 with the A11:2009 and A1:2010 amendments for protections against direct and indirect contact, for the separation of the extra low voltage DC circuits from the low voltage AC circuits and for earthing of metal parts.

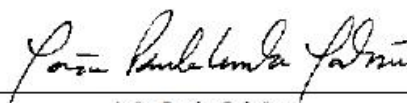

João Paulo Galvão
Managing Director

This panel is **CE** marked to show that it conforms to the requirements of the above European Community Directives:
It is assumed that the user of this manual is a suitably-trained operator/maintainer.

WARNING

THIS PANEL CONTAINS (LIVE) VOLTAGE. ALWAYS DISCONNECT THE MAINS SUPPLY FROM THE PANEL BEFORE REMOVING OR INSTALLING COMPONENTS.



ELECTRO-STATIC SENSITIVE DEVICES (ESD) TAKE SUITABLE ESD PRECAUTION WHEN REMOVING OR INSTALLING PRINTED CIRCUIT BOARDS.



GLOBAL FIRE EQUIPMENT S.A.

Sítio dos Barrabés, Armazém Nave Y, Caixa Postal 908-Z, 8150-016 São Brás de Alportel - PORTUGAL • Tel: +351 289 896 560
Sales: sales@globalfire-equipment.com • **Technical Support:** techs@globalfire-equipment.com • **www.globalfire-equipment.com**
