

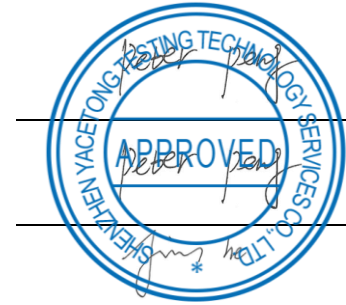

**TEST REPORT**  
**ETSI EN 301 893 V2.1.1 (2017-05)**

**Report Reference No.**.....: ATT2020SZ061005E4  
**Compiled by**  
( position+printed name+signature)...: File administrators Peter peng  
**Supervised by**  
( position+printed name+signature)...: Test Engineer Peter peng  
**Approved by**  
( position+printed name+signature)...: Manager Jim he  
**Date of issue**.....: Jun.03,2020



**Representative Laboratory Name** : **Shenzhen Yacetong Testing Technology Services Co., Ltd.**  
**Address**.....: Room 5009 Baode Industry Center,Baode Industry Center,Lixin South Road,Huaide Community Fuyong Baoan District,Shenzhen,China

**Applicant's name** .....: **SHENZHEN ITOONER TECHNOLOGY CO., LTD**  
**Address**.....: Building 2&Building 3(The 3rd and 4th Floor) GangZai Road, Shangxing Community,Xinqiao Street,Baoan District, Shenzhen, Guangdong, China

**Test specification** ..... :  
**Standard** .....: **ETSI EN 301 893 V2.1.1 (2017-05)**

**Shenzhen Yacetong Testing Technology Services Co., Ltd.. All rights reserved.**  
This publication may be reproduced in whole or in part for non-commercial purposes as long as the Shenzhen Yacetong Testing Technology Services Co., Ltd. is acknowledged as copyright owner and source of the material. Shenzhen Yacetong Testing Technology Services Co., Ltd. takes no responsibility for and will not assume liability for damages resulting from the reader's interpretation of the reproduced material due to its placement and context.

**Test item description**..... : AP  
**Trade Mark** .....: N/A  
**Manufacturer**.....: **SHENZHEN ITOONER TECHNOLOGY CO., LTD**  
**Model/Type reference**.....: GNT-AP290  
**List Model** .....: GNT-AP260,GNT-AP270,GNT-AP290,GNT-AP670,GNT-AP690,GN- AP61M15, GNT-AP54ME5,GNT-CP535,GNT-CP570,GNT-CP970,GNT-CP980  
**Operation Frequency** .....: From 5180MHz-5240MHz  
**Ratings**.....: DC 12V From Adapter  
**Result**.....: **PASS**



## TEST REPORT

<b>Test Report No. :</b>	ATT2020SZ061005E4	Jun. 03, 2020
		Date of issue

Equipment under Test : AP

Model /Type : GNT-AP290

Listed Models : GNT-AP260,GNT-AP270,GNT-AP290,GNT-AP670,GNT-AP690,  
GN- AP61M15,GNT-AP54ME5,GNT-CP535,GNT-CP570,GNT-CP970,  
GNT-CP980

**Applicant** : **SHENZHEN ITOONER TECHNOLOGY CO., LTD**

Address : Building 2&Building 3(The 3rd and 4th Floor) GangZai  
Road,Shangxing Community,Xinqiao Street,Baoan  
District, Shenzhen, Guangdong, China

**Manufacturer** : **SHENZHEN ITOONER TECHNOLOGY CO., LTD**

Address : Building 2&Building 3(The 3rd and 4th Floor) GangZai  
Road,Shangxing Community,Xinqiao Street,Baoan  
District, Shenzhen, Guangdong, China

<b>Test Result:</b>	<b>PASS</b>
---------------------	-------------

The test report merely corresponds to the test sample.  
It is not permitted to copy extracts of these test result without the written permission of the test laboratory.



## Contents

<b>1.</b>	<b><u>TEST STANDARDS .....</u></b>	<b><u>4</u></b>
<b>2.</b>	<b><u>SUMMARY .....</u></b>	<b><u>5</u></b>
2.1.	General Remarks	5
2.2.	Product Description	5
2.3.	Equipment Under Test	5
2.4.	EUT configuration	6
2.5.	Test summary	6
3.1.	Modifications	7
<b>4.</b>	<b><u>TEST ENVIRONMENT .....</u></b>	<b><u>8</u></b>
4.1.	Address of the test laboratory	8
4.2.	Environmental conditions	8
4.3.	Test Channels :	8
4.4.	Statement of the measurement uncertainty	9
4.5.	Equipments Used during the Test	10
<b>5.</b>	<b><u>TEST CONDITIONS AND RESULTS .....</u></b>	<b><u>12</u></b>
5.1.	Centre frequencies	12
5.2.	Nominal Channel Bandwidth and Occupied Channel Bandwidth	39
5.3.	RF output power, Transmit Power Control (TPC) and power density	44
5.4.	Transmitter unwanted emissions	61
5.4.1.	Transmitter unwanted emissions outside the 5 GHz RLAN bands .....	61
5.4.2.	Transmitter unwanted emissions within the 5 GHz RLAN bands .....	65
5.5.	Receiver spurious emissions	78
5.6.	Dynamic Frequency Selection (DFS)	82
5.7.	Adaptivity	160
5.8.	Receiver Blocking	183
5.9.	Geo-location capability	194
<b>6.</b>	<b><u>TEST SETUP PHOTOS OF THE EUT .....</u></b>	<b><u>195</u></b>
<b>7.</b>	<b><u>EXTERNAL AND INTERNAL PHOTOS OF THE EUT .....</u></b>	<b><u>195</u></b>



## **1. TEST STANDARDS**

The tests were performed according to following standards:

[ETSI EN 301 893 V2.1.1 \(2017-05\)](#)–5 GHz RLAN; Harmonised Standard covering the essential requirements of article 3.2 of Directive 2014/53/EU



## 2. SUMMARY

### 2.1. General Remarks

Date of receipt of test sample	:	May.25, 2020
Testing commenced on	:	May.25, 2020
Testing concluded on	:	Jun.03, 2020

### 2.2. Product Description

Product Name:	AP
Trade Mark:	N/A
Model/Type reference:	GNT-AP290
List Model:	GNT-AP260,GNT-AP270,GNT-AP290,GNT-AP670,GNT-AP690,GN- AP61M15, GNT-AP54ME5,GNT-CP535,GNT-CP570,GNT-CP970,GNT-CP980
Power supply:	DC 12V From Adapter
Auxiliary testing adapter information (Supplied by Test Lab ) :	Model: XH1200-1500LG Input: AC 100-240V~50/60Hz 0.5A Output:DC 12V 1.5A
Antenna Type	Internal Antenna
Operation frequency	802.11a/n/ac (20MHz): 5180~5700MHz 802.11n/ac(40MHz):5190~5670MHz 802.11ac(HT80):5210~5610MHz
Modulation Type	802.11a(OFDM): BPSK,QPSK,16-QAM,64-QAM 802.11n(OFDM): BPSK,QPSK,16-QAM,64-QAM 802.11ac(OFDM): BPSK,QPSK,16-QAM,64-QAM,256-QAM
Operation frequency	5180~5700MHz
Antenna Type	Integrated antenna
Antenna Gain	3dBi
Note	The EUT has two 5G ANT.

### 2.3. Equipment Under Test

#### Power supply system utilised

Power supply voltage	:	<input type="radio"/> 230V / 50 Hz	<input type="radio"/> 120V / 60Hz
		<input type="radio"/> 12 V DC	<input type="radio"/> 24 V DC
		<input checked="" type="radio"/> Other (specified in blank below)	

DC 12V From Adapter AC 230V/50Hz



**Channel list:**

Channel List for 802.11a/n/ac(20MHz)							
Channel	Frequency (MHz)	Channel	Frequency (MHz)	Channel	Frequency (MHz)	Channel	Frequency (MHz)
36	5180	40	5200	44	5220	48	5240
52	5260	56	5280	60	5300	64	5320
100	5500	116	5580	140	5700	--	--

Channel List for 802.11n/ac(40MHz)							
Channel	Frequency (MHz)	Channel	Frequency (MHz)	Channel	Frequency (MHz)	Channel	Frequency (MHz)
38	5190	46	5230	54	5270	62	5310
102	5510	110	5550	134	5670	--	--

Channel List for 802.11ac(80MHz)							
Channel	Frequency (MHz)	Channel	Frequency (MHz)	Channel	Frequency (MHz)	Channel	Frequency (MHz)
42	5210	58	5290	106	5530	122	5610
Channel	Frequency (MHz)						
138	5690						

**2.4. EUT configuration**

The following peripheral devices and interface cables were connected during the measurement:

● - supplied by the manufacturer

○ - supplied by the lab

○ /	M/N: /
	Manufacturer: /

**2.5. Test summary**

3. ETSI EN 301 893 V2.1.1 (2017-05)					
Clause	Test Item	Test channels		Higher sub-band 5 470 MHz to 5 725 MHz	Test results
		Lower sub-band (5 150 MHz to 5 350 MHz) 5 150 MHz to 5 250 MHz	5 250 MHz to 5 350 MHz		
5.4.2	Carrier frequencies	Y	Y	Y	Pass
5.4.3	Occupied Channel Bandwidth	Y	Y	Y	Pass



5.4.4	Power, power density	Y	Y	Y	Pass
5.4.5	Transmitter unwanted emissions outside 5 GHz RLAN bands	Y	Y	Y	Pass
5.4.6	Transmitter unwanted emissions within 5 GHz RLAN bands	Y	Y	Y	Pass
5.4.7	Receiver spurious emissions	Y	Y	Y	Pass
5.4.8	Dynamic Frequency Selection (DFS)	N	Y	Y	Pass
5.4.4	TransmitPowerControl(TPC)	N	Y	Y	Pass
5.4.9	Adaptivity	Y	Y	Y	Pass
5.4.10	Receiver Blocking	Y	Y	Y	Pass
4.2.9	User Access Restrictions	Y	Y	Y	Pass

*Note: 1. The test result judgment is decided by the limit of measurement standard  
2. The information of measurement uncertainty is available upon the customer's request.*

### **3.1. Modifications**

No modifications were implemented to meet testing criteria.



## **4. TEST ENVIRONMENT**

### **4.1. Address of the test laboratory**

Shenzhen Yaceton Testing Technology Services Co., Ltd.  
Room 5009 Baode Industry Center, Baode Industry Center, Lixin South Road, Huaide Community Fuyong Baoan District, Shenzhen, China

### **4.2. Environmental conditions**

During the measurement the environmental conditions were within the listed ranges:

Normal Temperature: 25 °C  
High Temperature: 40 °C  
Low Temperature: -10 °C  
Normal Voltage : AC 230V  
High Voltage: AC 240V  
Low Voltage: AC 207V  
Relative Humidity: 55 %  
Air Pressure: 989 hPa

### **4.3. Test Channels :**





Test	Clause	Test channels		
		Lower sub-band (5 150 MHz to 5 350 MHz)		Higher sub-band 5 725 MHz to 5 850 MHz
		5 150 MHz to 5 250 MHz	5 250 MHz to 5 350 MHz	
Centre frequencies	5.3.2	C7 (see note 1)		C8 (see note 1)
Occupied Channel Bandwidth	5.3.3	C7		C8
Power, power density	5.3.4	C1	C2	C3, C4
Transmitter unwanted emissions outside the 5 GHz RLAN bands	5.3.5	C7 (see note 1)		C8 (see note 1)
Transmitter unwanted emissions within the 5 GHz RLAN bands	5.3.6	C1	C2	C3, C4
Receiver spurious emissions	5.3.7	C7 (see note 1)		C8 (see note 1)
Transmit Power Control (TPC)	5.3.4	n.a. (see note 2)	C2 (see note 1)	C3, C4 (see note 1)
Dynamic Frequency Selection (DFS)	5.3.8	n.a. (see note 2)	C5	C6 (see note 3)
Adaptivity	5.3.9	C7		C8
C1, C3: The lowest declared channel for every declared nominal channel bandwidth within this band. For the power density testing, it is sufficient to only perform this test using the lowest nominal channel bandwidth. C2, C4: The highest declared channel for every declared nominal channel bandwidth within this band. For the power density testing, it is sufficient to only perform this test using the lowest nominal channel bandwidth. C5, C6: One channel out of the declared channels for this frequency range. If more than one nominal channel bandwidth has been declared for this sub-band, testing shall be performed using the lowest and highest nominal channel bandwidth. C7, C8: One channel out of the declared channels for this sub-band. For Occupied Channel Bandwidth, testing shall be repeated for every declared nominal channel bandwidth within this sub-band. For Adaptivity, testing shall be performed using the highest nominal channel bandwidth.				
NOTE 1: In case of more than one channel plan has been declared, testing of these specific requirements need only be performed using one of the declared channel plans.				
NOTE 2: Testing is not required for nominal channel bandwidths that fall completely within the frequency range 5 150 MHz to 5 250 MHz.				
NOTE 3: Where the declared channel plan includes channels whose nominal channel bandwidth falls completely or partly within the 5 600 MHz to 5 650 MHz band, the tests for the <i>Channel Availability Check</i> (and where implemented, for the <i>Off-Channel CAC</i> ) shall be performed on one of these channels in addition to a channel within the band 5 470 MHz to 5 600 MHz or within the band 5 650 MHz to 5 725 MHz.				

#### 4.4. Statement of the measurement uncertainty

The data and results referenced in this document are true and accurate. The reader is cautioned that there may be errors within the calibration limits of the equipment and facilities. The measurement uncertainty was calculated for all measurements listed in this test report acc. to TR-100028-01 "Electromagnetic compatibility and Radio spectrum Matters (ERM);Uncertainties in the measurement of mobile radio equipment characteristics;Part 1" and TR-100028-02 "Electromagnetic compatibility and Radio spectrum Matters (ERM);Uncertainties in the measurement of mobile radio equipment characteristics;Part 2" and is documented in the Shenzhen Global Test Service Co.,Ltd quality system acc. to DIN EN ISO/IEC 17025. Furthermore, component and process variability of devices similar to that tested may result in additional deviation. The manufacturer has the sole responsibility of continued compliance of the device.

Hereafter the best measurement capability for Shenzhen GTS laboratory is reported:

Test Items	Measurement Uncertainty	Notes
Frequency error	25 Hz	(1)
Transmitter power conducted	0.57 dB	(1)
Transmitter power Radiated	2.20 dB	(1)
Conducted spurious emission	1.60 dB	(1)
Radiated spurious emission	2.20 dB	(1)

(1) This uncertainty represents an expanded uncertainty expressed at approximately the 95% confidence level using a coverage factor of k=2.



#### 4.5. Equipments Used during the Test

RF output power&PSD&OOB&OBW &Hoping &Duty Cycle, Tx-sequence, Tx-gap & Adaptively& Receiver Blocking						
Item	Test Equipment	Manufacturer	Model No.	Serial No.	Calibration Date	Calibration Due Date
1	Spectrum Analyzer	Agilent	N9020A	MY48010425	2019/09/19	2020/09/18
2	Vector Signal generator	Agilent	N5181A	MY49060502	2019/09/19	2020/09/18
3	Signal generator	Agilent	E4421B	3610AO1069	2019/09/19	2020/09/18
4	4 Ch. Simultaneous Sampling 14 Bits 2 MS/s	Agilent	U2531A	TW54063513	2019/09/19	2020/09/18
5	X-series USB Peak and Average Power Sensor	Agilent	U2021XA	MY54080019	2019/09/19	2020/09/18
6	Climate Chamber	ESPEC	EL-10KA	A20120523	2019/09/19	2020/09/18
7	Radio Communication Tester	Rohde&Schwarz	CMW500	115406	2019/09/19	2020/09/18

Transmitter spurious emissions & Receiver spurious emissions						
Item	Test Equipment	Manufacturer	Model No.	Serial No.	Calibration Date	Calibration Due Date
1	ULTRA-BROADBAND ANTENNA	Schwarzbeck	VULB9163	000976	2019/09/19	2020/09/18
2	Horn Antenna	Schwarzbeck	BBHA 9120D	01622	2019/09/19	2020/09/18
3	EMI Test Receiver	Rohde&Schwarz	ESCI	101102	2019/09/19	2020/09/18
4	Spectrum Analyzer	Agilent	N9020A	MY48010425	2019/09/19	2020/09/18
5	Pre-Amplifier	Schwarzbeck	BBV 9743	#202	2019/09/19	2020/09/18
6	Pre-Amplifier	Chenyi	EMC051845B	980355	2019/09/19	2020/09/18
7	High-Pass Filter	K&L	9SH10-2700/X12750-O/O	N/A	2019/09/19	2020/09/18
8	High-Pass Filter	K&L	41H10-1375/U12750-O/O	N/A	2019/09/19	2020/09/18
9	RF Cable	HUBER+SUHNER	C102	N/A	2019/09/19	2020/09/18

The calibration interval is 1 year.





## **5. TEST CONDITIONS AND RESULTS**

### **5.1. Centre frequencies**

#### **Limit**

The actual centre frequency for any given channel declared by the manufacturer shall be maintained within the range  $f_c \pm 20$  ppm.

#### **Test Procedure**

1. For equipment can operating without modulation
  - a Connected The UUT to the spectrum and operated in an unmodulated mode.
  - b Set the centre frequency of spectrum to the frequency which UUT operated.
  - c Max Hold and waiting the trace stabilized.
  - d Search the peak value of the power envelope and noted.
2. For equipment operating with modulation
  - a Connected The UUT to the spectrum.
  - b Set the centre frequency of spectrum to the frequency which UUT operated.
  - c Max Hold and waiting the trace stabilized.
  - d Search the peak value of the power envelope and noted.
  - e Move the marker in a positive frequency increment until the upper, (relative to the centre frequency), -10 dBc point is reached, note this point as f1.
  - f Move the marker in a negative frequency increment until the lower, (relative to the centre frequency), -10 dBc point is reached, note this point as f2.
  - g The centre frequency is calculated as  $(f1 + f2) / 2$ .
3. These measurements shall be performed under both normal and extreme test conditions.
4. One channel out of the declared channels for each sub-band shall be tested.

#### **Test Results**

##### **5150-5250MHz**

Note:Antenna A Power> Antenna B Power,Both antenna A and B have been test, Only show the worst data of Antenna A

##### **Antenna A**

802.11a(CH36)



TEST CONDITIONS	CENTRE FREQUENCIES ( ppm )		
	5180MHz		
	Frequency	Frequency Error	
(KHz)		(ppm)	
T nom (°C)	5180.0512	51.20	9.88
T min (°C)	5180.0517	51.70	9.98
T max (°C)	5180.0518	51.80	10.00
Max Frequency Error	51.20(KHz)		
Limits	± 20 ppm=Limit(105K)		
Result	Complies		

**Antenna A**  
 802.11a(CH40)

TEST CONDITIONS	CENTRE FREQUENCIES ( ppm )		
	5200MHz		
	Frequency	Frequency Error	
(KHz)		(ppm)	
T nom (°C)	5200.0462	46.20	8.88
T min (°C)	5200.0427	42.70	8.21
T max (°C)	5200.0457	45.70	8.79
Max Frequency Error	26.2(KHz)		
Limits	± 20 ppm=Limit(105K)		
Result	Complies		

**Antenna A**  
 802.11a(CH48)



TEST CONDITIONS	CENTRE FREQUENCIES ( ppm )		
	5240MHz		
	Frequency	Frequency Error	
(KHz)		(ppm)	
T nom (°C)	5240.0518	51.80	9.89
T min (°C)	5240.0517	51.70	9.87
T max (°C)	5240.0519	51.90	9.90
Max Frequency Error	51.90(KHz)		
Limits	± 20 ppm=Limit(105K)		
Result	Complies		

**Antenna A**

802.11n(HT20) CH36

TEST CONDITIONS	CENTRE FREQUENCIES ( ppm )		
	5180MHz		
	Frequency	Frequency Error	
(KHz)		(ppm)	
T nom (°C)	5180.0502	50.20	9.69
T min (°C)	5180.0512	51.20	9.88
T max (°C)	5180.0505	50.50	9.75
Max Frequency Error	51.20(KHz)		
Limits	± 20 ppm=Limit(105K)		
Result	Complies		



**Antenna A**

8802.11n(HT20) CH40

TEST CONDITIONS	CENTRE FREQUENCIES ( ppm )		
	5200MHz		
	Frequency	Frequency Error	
(KHz)		(ppm)	
T nom (°C)	5200.0512	51.20	9.85
T min (°C)	5200.0511	51.10	9.83
T max (°C)	5200.0513	51.30	9.87
Max Frequency Error	51.30(KHz)		
Limits	± 20 ppm=Limit(105K)		
Result	Complies		



**Antenna A**

802.11n(HT20) CH48

TEST CONDITIONS	CENTRE FREQUENCIES ( ppm )		
	5240MHz		
	Frequency	Frequency Error	
(KHz)		(ppm)	
T nom (°C)	5240.0512	51.20	9.77
T min (°C)	5240.0513	51.30	9.79
T max (°C)	5240.0515	51.50	9.83
Max Frequency Error	51.50(KHz)		
Limits	± 20 ppm=Limit(105K)		
Result	Complies		

**Antenna A**

802.11n(HT40) CH38

TEST CONDITIONS	CENTRE FREQUENCIES ( ppm )		
	5190MHz		
	Frequency	Frequency Error	
(KHz)		(ppm)	
T nom (°C)	5190.0513	51.30	9.88
T min (°C)	5190.0515	51.50	9.92
T max (°C)	5190.0511	51.10	9.85
Max Frequency Error	51.30(KHz)		
Limits	± 20 ppm=Limit(105K)		
Result	Complies		





**Antenna A**

802.11n(HT40) CH46

TEST CONDITIONS	CENTRE FREQUENCIES ( ppm )		
	5230MHz		
	Frequency	Frequency Error	
(KHz)		(ppm)	
T nom (°C)	5230.0517	51.70	9.89
T min (°C)	5230.0511	51.10	9.77
T max (°C)	5230.0513	51.30	9.81
Max Frequency Error	51.70(KHz)		
Limits	± 20 ppm=Limit(105K)		
Result	Complies		

**Antenna A**

802.11ac(HT20) CH36

TEST CONDITIONS	CENTRE FREQUENCIES ( ppm )		
	5180MHz		
	Frequency	Frequency Error	
(KHz)		(ppm)	
T nom (°C)	5180.0514	51.40	9.92
T min (°C)	5180.0511	51.10	9.86
T max (°C)	5180.0513	51.30	9.90
Max Frequency Error	51.40(KHz)		
Limits	± 20 ppm=Limit(105K)		
Result	Complies		



**Antenna A**

802.11ac(HT20) CH40

TEST CONDITIONS	CENTRE FREQUENCIES ( ppm )		
	5200MHz		
	Frequency	Frequency Error	
(KHz)		(ppm)	
T nom (°C)	5200.0475	47.50	9.13
T min (°C)	5200.0413	41.30	7.94
T max (°C)	5200.0461	46.10	8.87
Max Frequency Error	47.50(KHz)		
Limits	± 20 ppm=Limit(105K)		
Result	Complies		

**Antenna A**

802.11ac(HT20) CH48



TEST CONDITIONS	CENTRE FREQUENCIES ( ppm )		
	5240MHz		
	Frequency	Frequency Error	
(KHz)		(ppm)	
T nom (°C)	5240.0475	47.50	9.06
T min (°C)	5240.0413	41.30	7.88
T max (°C)	5240.0461	46.10	8.80
Max Frequency Error	47.50(KHz)		
Limits	± 20 ppm=Limit(105K)		
Result	Complies		

**Antenna A**

802.11ac(HT40) CH38

TEST CONDITIONS	CENTRE FREQUENCIES ( ppm )		
	5190MHz		
	Frequency	Frequency Error	
(KHz)		(ppm)	
T nom (°C)	5190.0475	47.50	9.15
T min (°C)	5190.0413	41.30	7.96
T max (°C)	5190.0461	46.10	8.88
Max Frequency Error	47.50(KHz)		
Limits	± 20 ppm=Limit(105K)		
Result	Complies		



**Antenna A**

802.11ac(HT40) CH46

TEST CONDITIONS	CENTRE FREQUENCIES ( ppm )		
	5230MHz		
	Frequency	Frequency Error	
(KHz)		(ppm)	
T nom (°C)	5230.0475	47.50	9.08
T min (°C)	5230.0413	41.30	7.90
T max (°C)	5230.0461	46.10	8.81
Max Frequency Error	47.50(KHz)		
Limits	± 20 ppm=Limit(105K)		
Result	Complies		

**Antenna A**

802.11ac(HT80) CH42



TEST CONDITIONS	CENTRE FREQUENCIES ( ppm )		
	5210MHz		
	Frequency	Frequency Error	
(KHz)		(ppm)	
T nom (°C)	5210.0475	47.50	9.12
T min (°C)	5210.0413	41.30	7.93
T max (°C)	5210.0461	46.10	8.85
Max Frequency Error	47.50(KHz)		
Limits	± 20 ppm=Limit(105K)		
Result	Complies		

**5250-5350MHz**

Note: Antenna A Power> Antenna B Power, Both antenna A and B have been test, Only show the worst data of Antenna A.

**Antenna A**

802.11a(CH52)

TEST CONDITIONS	CENTRE FREQUENCIES ( ppm )		
	5260MHz		
	Frequency	Frequency Error	
(KHz)		(ppm)	
T nom (°C)	5260.0475	47.50	9.03
T min (°C)	5260.0413	41.30	7.85
T max (°C)	5260.0461	46.10	8.76
Max Frequency Error	47(KHz)		
Limits	± 20 ppm=Limit(105K)		
Result	Complies		



**Antenna A**

802.11a (CH60)

TEST CONDITIONS	CENTRE FREQUENCIES ( ppm )		
	5300MHz		
	Frequency	Frequency Error	
(KHz)		(ppm)	
T nom (°C)	5300.0475	47.50	8.96
T min (°C)	5300.0413	41.30	7.79
T max (°C)	5300.0461	46.10	8.70
Max Frequency Error	47.50(KHz)		
Limits	± 20 ppm=Limit(105K)		
Result	Complies		

**Antenna A**

802.11a (CH64)

TEST CONDITIONS	CENTRE FREQUENCIES ( ppm )		
	5320MHz		
	Frequency	Frequency Error	
(KHz)		(ppm)	
T nom (°C)	5320.0475	47.50	8.93
T min (°C)	5320.0413	41.30	7.76
T max (°C)	5320.0461	46.10	8.67
Max Frequency Error	47.50(KHz)		
Limits	± 20 ppm=Limit(105K)		
Result	Complies		



**Antenna A**

802.11n(HT20) CH52

TEST CONDITIONS	CENTRE FREQUENCIES ( ppm )		
	5260MHz		
	Frequency	Frequency Error	
(KHz)		(ppm)	
T nom (°C)	5260.0475	47.50	9.03
T min (°C)	5260.0413	41.30	7.85
T max (°C)	5260.0461	46.10	8.76
Max Frequency Error	47.50(KHz)		
Limits	± 20 ppm=Limit(105K)		
Result	Complies		

**Antenna A**

802.11n(HT20) CH60

TEST CONDITIONS	CENTRE FREQUENCIES ( ppm )		
	5300MHz		
	Frequency	Frequency Error	
(KHz)		(ppm)	
T nom (°C)	5300.0475	47.50	8.96
T min (°C)	5300.0413	41.30	7.79
T max (°C)	5300.0461	46.10	8.70
Max Frequency Error	47.50(KHz)		
Limits	± 20 ppm=Limit(105K)		
Result	Complies		



**Antenna A**

802.11n(HT20) CH64

TEST CONDITIONS	CENTRE FREQUENCIES ( ppm )		
	5320MHz		
	Frequency	Frequency Error	
(KHz)		(ppm)	
T nom (°C)	5320.0475	47.50	8.93
T min (°C)	5320.0413	41.30	7.76
T max (°C)	5320.0461	46.10	8.67
Max Frequency Error	47.50(KHz)		
Limits	± 20 ppm=Limit(105K)		
Result	Complies		

**Antenna A**

802.11n(HT40) CH54

TEST CONDITIONS	CENTRE FREQUENCIES ( ppm )		
	5270MHz		
	Frequency	Frequency Error	
(KHz)		(ppm)	
T nom (°C)	5270.0475	47.50	9.01
T min (°C)	5270.0413	41.30	7.84
T max (°C)	5270.0461	46.10	8.75
Max Frequency Error	47.50(KHz)		
Limits	± 20 ppm=Limit(105K)		
Result	Complies		





**Antenna A**

802.11n(HT40) CH62

TEST CONDITIONS	CENTRE FREQUENCIES ( ppm )		
	5310MHz		
	Frequency	Frequency Error	
(KHz)		(ppm)	
T nom (°C)	5310.0475	47.50	8.95
T min (°C)	5310.0413	41.30	7.78
T max (°C)	5310.0461	46.10	8.68
Max Frequency Error	47.50(KHz)		
Limits	± 20 ppm=Limit(105K)		
Result	Complies		

**Antenna A**

802.11ac(HT20) CH52

TEST CONDITIONS	CENTRE FREQUENCIES ( ppm )		
	5260MHz		
	Frequency	Frequency Error	
(KHz)		(ppm)	
T nom (°C)	5260.0475	47.50	9.03
T min (°C)	5260.0413	41.30	7.85
T max (°C)	5260.0461	46.10	8.76
Max Frequency Error	47.50(KHz)		
Limits	± 20 ppm=Limit(105K)		
Result	Complies		



**Antenna A**

802.11ac(HT20) CH60

TEST CONDITIONS	CENTRE FREQUENCIES ( ppm )		
	5300MHz		
	Frequency	Frequency Error	
(KHz)		(ppm)	
T nom (°C)	5300.0475	47.50	8.96
T min (°C)	5300.0413	41.30	7.79
T max (°C)	5300.0461	46.10	8.70
Max Frequency Error	47.50(KHz)		
Limits	± 20 ppm=Limit(105K)		
Result	Complies		

**Antenna A**

802.11ac(HT20) CH64



TEST CONDITIONS	CENTRE FREQUENCIES ( ppm )		
	5320MHz		
	Frequency	Frequency Error	
(KHz)		(ppm)	
T nom (°C)	5320.0475	47.50	8.93
T min (°C)	5320.0413	41.30	7.76
T max (°C)	5320.0461	46.10	8.67
Max Frequency Error	47.50(KHz)		
Limits	± 20 ppm=Limit(105K)		
Result	Complies		

**Antenna A**

802.11ac(HT40) CH54

TEST CONDITIONS	CENTRE FREQUENCIES ( ppm )		
	5270MHz		
	Frequency	Frequency Error	
(KHz)		(ppm)	
T nom (°C)	5270.0475	47.50	9.01
T min (°C)	5270.0413	41.30	7.84
T max (°C)	5270.0461	46.10	8.75
Max Frequency Error	47.50(KHz)		
Limits	± 20 ppm=Limit(105K)		
Result	Complies		

**Antenna A**

802.11ac(HT40) CH62



TEST CONDITIONS	CENTRE FREQUENCIES ( ppm )		
	5310MHz		
	Frequency	Frequency Error	
		(KHz)	(ppm)
T nom (°C)	5310.0475	47.50	8.95
T min (°C)	5310.0413	41.30	7.78
T max (°C)	5310.0461	46.10	8.68
Max Frequency Error	47.50(KHz)		
Limits	± 20 ppm=Limit(105K)		
Result	Complies		



**Antenna A**

802.11ac(HT80) CH58

TEST CONDITIONS	CENTRE FREQUENCIES ( ppm )		
	5290MHz		
	Frequency	Frequency Error	
(KHz)		(ppm)	
T nom (°C)	5290.0475	47.50	8.98
T min (°C)	5290.0413	41.30	7.81
T max (°C)	5290.0461	46.10	8.71
Max Frequency Error	47.50(KHz)		
Limits	± 20 ppm=Limit(105K)		
Result	Complies		

**5470-5725MHz**

NOTE: Antenna A Power> Antenna B Power, Both antenna A and B all have been test,Only show the worst data of Antenna A

**Antenna A**

802.11a CH100

TEST CONDITIONS	CENTRE FREQUENCIES ( ppm )		
	5500MHz		
	Frequency	Frequency Error	
(KHz)		(ppm)	
T nom (°C)	5500.0475	47.50	8.64
T min (°C)	5500.0413	41.30	7.51
T max (°C)	5500.0461	46.10	8.38
Max Frequency Error	47.50(KHz)		
Limits	± 20 ppm=Limit(105K)		
Result	Complies		



**Antenna A**

802.11a CH116

TEST CONDITIONS	CENTRE FREQUENCIES ( ppm )		
	5580MHz		
	Frequency	Frequency Error	
(KHz)		(ppm)	
T nom (°C)	5580.0475	47.50	8.51
T min (°C)	5580.0413	41.30	7.40
T max (°C)	5580.0461	46.10	8.26
Max Frequency Error	47.50(KHz)		
Limits	± 20 ppm=Limit(105K)		
Result	Complies		

**Antenna A**

802.11a CH140

TEST CONDITIONS	CENTRE FREQUENCIES ( ppm )		
	5700MHz		
	Frequency	Frequency Error	
(KHz)		(ppm)	
T nom (°C)	5700.0475	47.50	8.33
T min (°C)	5700.0413	41.30	7.25
T max (°C)	5700.0461	46.10	8.09
Max Frequency Error	47.50(KHz)		
Limits	± 20 ppm=Limit(105K)		
Result	Complies		



**Antenna A**

802.11n(HT20) CH100

TEST CONDITIONS	CENTRE FREQUENCIES ( ppm )		
	5550MHz		
	Frequency	Frequency Error	
(KHz)		(ppm)	
T nom (°C)	5550.0475	47.50	8.64
T min (°C)	5550.0413	41.30	7.51
T max (°C)	5550.0461	46.10	8.38
Max Frequency Error	47.50(KHz)		
Limits	± 20 ppm=Limit(105K)		
Result	Complies		

**Antenna A**

802.11n(HT20) CH116

TEST CONDITIONS	CENTRE FREQUENCIES ( ppm )		
	5580MHz		
	Frequency	Frequency Error	
(KHz)		(ppm)	
T nom (°C)	5580.0475	47.50	8.51
T min (°C)	5580.0413	41.30	7.40
T max (°C)	5580.0461	46.10	8.26
Max Frequency Error	47(KHz)		
Limits	± 20 ppm=Limit(105K)		
Result	Complies		



**Antenna A**

802.11n(HT20) CH140

TEST CONDITIONS	CENTRE FREQUENCIES ( ppm )		
	5700MHz		
	Frequency	Frequency Error	
(KHz)		(ppm)	
T nom (°C)	5700.0475	47.50	8.33
T min (°C)	5700.0413	41.30	7.25
T max (°C)	5700.0461	46.10	8.09
Max Frequency Error	47(KHz)		
Limits	± 20 ppm=Limit(105K)		
Result	Complies		

**Antenna A**

802.11n(HT40) CH102

TEST CONDITIONS	CENTRE FREQUENCIES ( ppm )		
	5510MHz		
	Frequency	Frequency Error	
(KHz)		(ppm)	
T nom (°C)	5510.0475	47.50	8.62
T min (°C)	5510.0413	41.30	7.50
T max (°C)	5510.0461	46.10	8.37
Max Frequency Error	47.50(KHz)		
Limits	± 20 ppm=Limit(105K)		
Result	Complies		





**Antenna A**

802.11n(HT40) CH110

TEST CONDITIONS	CENTRE FREQUENCIES ( ppm )		
	5550MHz		
	Frequency	Frequency Error	
(KHz)		(ppm)	
T nom (°C)	5550.0475	47.50	8.56
T min (°C)	5550.0413	41.30	7.44
T max (°C)	5550.0461	46.10	8.31
Max Frequency Error	47.50(KHz)		
Limits	± 20 ppm=Limit(105K)		
Result	Complies		

**Antenna A**

802.11ac(HT40) CH134

TEST CONDITIONS	CENTRE FREQUENCIES ( ppm )		
	5670MHz		
	Frequency	Frequency Error	
(KHz)		(ppm)	
T nom (°C)	5670.0475	47.50	8.38
T min (°C)	5670.0413	41.30	7.28
T max (°C)	5670.0461	46.10	8.13
Max Frequency Error	47.50(KHz)		
Limits	± 20 ppm=Limit(105K)		
Result	Complies		



**Antenna A**

802.11ac(HT20) CH100

TEST CONDITIONS	CENTRE FREQUENCIES ( ppm )		
	5550MHz		
	Frequency	Frequency Error	
(KHz)		(ppm)	
T nom (°C)	5550.0475	47.50	8.64
T min (°C)	5550.0413	41.30	7.51
T max (°C)	5550.0461	46.10	8.38
Max Frequency Error	47.50(KHz)		
Limits	± 20 ppm=Limit(105K)		
Result	Complies		

**Antenna A**

802.11ac(HT20) CH116

TEST CONDITIONS	CENTRE FREQUENCIES ( ppm )		
	5580MHz		
	Frequency	Frequency Error	
(KHz)		(ppm)	
T nom (°C)	5580.0475	47.50	8.51
T min (°C)	5580.0413	41.30	7.40
T max (°C)	5580.0461	46.10	8.26
Max Frequency Error	47.50(KHz)		
Limits	± 20 ppm=Limit(105K)		
Result	Complies		



**Antenna A**

802.11ac(HT20) CH140

TEST CONDITIONS	CENTRE FREQUENCIES ( ppm )		
	5700MHz		
	Frequency	Frequency Error	
(KHz)		(ppm)	
T nom (°C)	5700.0475	47.50	8.33
T min (°C)	5700.0413	41.30	7.25
T max (°C)	5700.0461	46.10	8.09
Max Frequency Error	47.50(KHz)		
Limits	± 20 ppm=Limit(105K)		
Result	Complies		

**Antenna A**

802.11ac(HT40) CH102

TEST CONDITIONS	CENTRE FREQUENCIES ( ppm )		
	5510MHz		
	Frequency	Frequency Error	
(KHz)		(ppm)	
T nom (°C)	5510.0475	47.50	8.62
T min (°C)	5510.0413	41.30	7.50
T max (°C)	5510.0461	46.10	8.37
Max Frequency Error	47.50(KHz)		
Limits	± 20 ppm=Limit(105K)		
Result	Complies		



**Antenna A**

802.11ac(HT40) CH110

TEST CONDITIONS	CENTRE FREQUENCIES ( ppm )		
	5550MHz		
	Frequency	Frequency Error	
(KHz)		(ppm)	
T nom (°C)	5550.0475	47.50	8.56
T min (°C)	5550.0413	41.30	7.44
T max (°C)	5550.0461	46.10	8.31
Max Frequency Error	47.50(KHz)		
Limits	± 20 ppm=Limit(105K)		
Result	Complies		

**Antenna A**

802.11ac(HT40) CH134

TEST CONDITIONS	CENTRE FREQUENCIES ( ppm )		
	5670MHz		
	Frequency	Frequency Error	
(KHz)		(ppm)	
T nom (°C)	5670.0475	47.50	8.38
T min (°C)	5670.0413	41.30	7.28
T max (°C)	5670.0461	46.10	8.13
Max Frequency Error	47.50(KHz)		
Limits	± 20 ppm=Limit(105K)		
Result	Complies		



**Antenna A**

802.11ac(HT80) CH106

TEST CONDITIONS	CENTRE FREQUENCIES ( ppm )		
	5530MHz		
	Frequency	Frequency Error	
(KHz)		(ppm)	
T nom (°C)	5530.0475	47.50	8.59
T min (°C)	5530.0413	41.30	7.47
T max (°C)	5530.0461	46.10	8.34
Max Frequency Error	47.50(KHz)		
Limits	± 20 ppm=Limit(105K)		
Result	Complies		

**Antenna A**

802.11ac(HT80) CH122

TEST CONDITIONS	CENTRE FREQUENCIES ( ppm )		
	5610MHz		
	Frequency	Frequency Error	
(KHz)		(ppm)	
T nom (°C)	5610.0475	47.50	8.47
T min (°C)	5610.0413	41.30	7.36
T max (°C)	5610.0461	46.10	8.22
Max Frequency Error	47.50(KHz)		
Limits	± 20 ppm=Limit(105K)		
Result	Complies		



### Antenna A

802.11ac(HT80) CH138

TEST CONDITIONS	CENTRE FREQUENCIES ( ppm )		
	5690MHz		
	Frequency	Frequency Error	
(KHz)		(ppm)	
T nom (°C)	5690.0475	47.50	8.35
T min (°C)	5690.0413	41.30	7.26
T max (°C)	5690.0461	46.10	8.10
Max Frequency Error	47.50(KHz)		
Limits	± 20 ppm=Limit(105K)		
Result	Complies		



**LIMIT**

The Nominal Channel Bandwidth for a single Operating Channel shall be 20 MHz

Alternatively, equipment may implement a lower Nominal Channel Bandwidth with a minimum of 5 MHz, providing they still comply with the Nominal Centre Frequencies defined in clause 4.2.1 (20 MHz raster).

The Occupied Channel Bandwidth shall be between 80 % and 100 % of the Nominal Channel Bandwidth. In case of smart antenna systems (devices with multiple transmit chains) each of the transmit chains shall meet this requirement.

The Occupied Channel Bandwidth might change with time/payload.

During a Channel Occupancy Time (COT), equipment may operate temporarily with an Occupied Channel Bandwidth of less than 80 % of its Nominal Channel Bandwidth with a minimum of 2 MHz

**Test Procedure**

1. Connect the UUT to the spectrum analyser and use the following settings:

Centre Frequency:	The centre frequency of the channel under test
Resolution Bandwidth:	100 kHz
Video Bandwidth:	300 kHz
Frequency Span:	2 × Nominal Bandwidth (e.g. 40 MHz for a 20 MHz channel)
Detector Mode:	Peak
Trace Mode:	Max Hold

2. When the trace is complete, capture the trace.
3. Find the peak value of the trace and place the analyser marker on this peak.
4. Use the 99 % bandwidth function of the spectrum analyser to measure the Occupied Channel Bandwidth of the UUT. This value shall be recorded.
5. Repeated steps 1 to 3 above in case of simultaneous transmissions in non-adjacent channels.
6. These measurements shall be performed only under normal operating conditions.
7. One channel out of the declared channels for each sub-band shall be tested.

**TEST RESULTS**

**5150-5250MHz Band I**

802. 11a

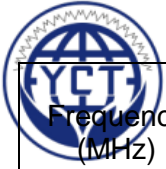

Frequency (MHz)	Declared Bandwidth (MHz)	99% Bandwidth (MHz)			Limit (MHz)	Test Result
		ANTENNA -A	ANTENNA -B	/		
5180MHz	20	16.448	16.446	/	16-20	Pass
5200MHz	20	16.445	16.444	/	16-20	Pass
5240MHz	20	16.448	16.445	/	16-20	Pass

802.11n(HT20)

Frequency (MHz)	Declared Bandwidth (MHz)	99% Bandwidth (MHz)			Limit (MHz)	Test Result
		ANTENNA -A	ANTENNA -B	/		
5180MHz	20	17.654	17.653	/	16-20	Pass
5200MHz	20	17.647	17.645	/	16-20	Pass
5240MHz	20	17.648	17.647	/	16-20	Pass

802.11n(HT40)

Frequency (MHz)	Declared Bandwidth (MHz)	99% Bandwidth (MHz)			Limit (MHz)	Test Result
		ANTENNA -A	ANTENNA -B	/		
5190MHz	40	36.221	36.220	/	35-40	Pass
5230MHz	40	36.221	36.220	/	35-40	Pass

802.11ac(HT20)

Frequency (MHz)	Declared Bandwidth (MHz)	99% Bandwidth (MHz)			Limit (MHz)	Test Result
		ANTENNA -A	ANTENNA -B	/		
5180MHz	20	17.649	17.646	/	16-20	Pass
5200MHz	20	17.650	17.650	/	16-20	Pass
5240MHz	20	17.651	17.650	/	16-20	Pass

802.11ac(HT40)



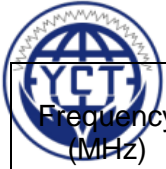

Frequency (MHz)	Declared Bandwidth (MHz)	99% Bandwidth (MHz)			Limit (MHz)	Test Result
		ANTENNA -A	ANTENNA -B	/		
5190MHz	40	36.221	36.220	/	35-40	Pass
5230MHz	40	36.219	36.217	/	35-40	Pass

802.11ac(HT80)

Frequency (MHz)	Declared Bandwidth (MHz)	99% Bandwidth (MHz)			Limit (MHz)	Test Result
		ANTENNA -A	ANTENNA -B	/		
5210MHz	42	75.628	75.626	/	74-80	Pass

**5250-5350MHz Band II**

802.11a

Frequency (MHz)	Declared Bandwidth (MHz)	99% Bandwidth (MHz)			Limit (MHz)	Test Result
		ANTENNA -A	ANTENNA -B	/		
5260MHz	20	16.447	16.446	/	16-20	Pass
5300MHz	20	16.447	16.446	/	16-20	Pass
5320MHz	20	16.446	16.445	/	16-20	Pass

802.11n(HT20)

Frequency (MHz)	Declared Bandwidth (MHz)	99% Bandwidth (MHz)			Limit (MHz)	Test Result
		ANTENNA -A	ANTENNA -B	/		
5260MHz	20	17.652	17.651	/	16-20	Pass
5300MHz	20	17.651	17.650	/	16-20	Pass
5320MHz	20	17.650	17.650	/	16-20	Pass

802.11n(HT40)

Frequency (MHz)	Declared Bandwidth (MHz)	99% Bandwidth (MHz)			Limit (MHz)	Test Result
		ANTENNA -A	ANTENNA -B	/		
5270MHz	40	36.216	36.217	/	35-40	Pass
5310MHz	40	36.216	36.215	/	35-40	Pass

802.11ac(HT20)

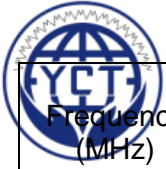

Frequency (MHz)	Declared Bandwidth (MHz)	99% Bandwidth (MHz)			Limit (MHz)	Test Result
		ANTENNA -A	ANTENNA -B	/		
5260MHz	20	17.651	17.650	/	16-20	Pass
5300MHz	20	17.652	17.651	/	16-20	Pass
5320MHz	20	17.652	17.651	/	16-20	Pass

Report No. ATT2020SZ0610054  
Page 42 of 195

Frequency (MHz)	Declared Bandwidth (MHz)	99% Bandwidth (MHz)			Limit (MHz)	Test Result
		ANTENNA -A	ANTENNA -B	/		
5270MHz	40	36.217	36.215	/	35-40	Pass
5310MHz	40	36.217	36.215	/	35-40	Pass

Frequency (MHz)	Declared Bandwidth (MHz)	99% Bandwidth (MHz)			Limit (MHz)	Test Result
		ANTENNA -A	ANTENNA -B	/		
5290MHz	42	75.595	75.593	/	74-80	Pass

802.11ac(HT40)

Frequency (MHz)	Declared Bandwidth (MHz)	99% Bandwidth (MHz)			Limit (MHz)	Test Result
		ANTENNA -A	ANTENNA -B	/		
5500MHz	20	16.453	16.452	/	16-20	Pass
5580MHz	20	16.451	16.450	/	16-20	Pass
5700MHz	20	16.449	16.448	/	16-20	Pass

802.11ac(HT80)

**5470-5725MHz Band III**

802.11a



802.11n(HT20)

Frequency (MHz)	DeclaredBandwidth (MHz)	99% Bandwidth (MHz)			Limit (MHz)	Test Result
		ANTENNA -A	ANTENNA -B	/		
5500MHz	20	17.652	17.651	/	16-20	Pass
5580MHz	20	17.654	17.653	/	16-20	Pass
5700MHz	20	17.657	17.656	/	16-20	Pass

802.11n(HT40)

Frequency (MHz)	DeclaredBandwidth (MHz)	99% Bandwidth (MHz)			Limit (MHz)	Test Result
		ANTENNA -A	ANTENNA -B	/		
5510MHz	40	36.219	36.218	/	35-40	Pass
5550MHz	40	36.233	36.232	/	35-40	Pass
5670MHz	40	36.223	36.222	/	35-40	Pass

802.11ac(HT20)

Frequency (MHz)	DeclaredBandwidth (MHz)	99% Bandwidth (MHz)			Limit (MHz)	Test Result
		ANTENNA -A	ANTENNA -B	/		
5500MHz	20	17.650	17.650	/	16-20	Pass
5580MHz	20	17.653	17.652	/	16-20	Pass
5700MHz	20	17.652	17.651	/	16-20	Pass

802.11ac(HT40)

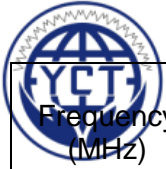

Frequency (MHz)	Declared Bandwidth (MHz)	99% Bandwidth (MHz)			Report No. ATT2020SZ0610054	Limit (MHz)	Test Result
		ANTENNA -A	ANTENNA -B	Page /			
5510MHz	40	36.217	36.216	/	35-40	Pass	
5550MHz	40	36.230	36.230	/	35-40	Pass	
5670MHz	40	36.223	36.222	/	35-40	Pass	

### 802.11ac(HT80)

Frequency (MHz)	Declared Bandwidth (MHz)	99% Bandwidth (MHz)			Limit (MHz)	Test Result
		ANTENNA -A	ANTENNA -B	/		
5530MHz	42	75.649	75.648	/	74-80	Pass
5610MHz	42	75.637	75.636	/	74-80	Pass
5690MHz	42	75.632	75.631	/	74-80	Pass

### 5.3. RF output power, Transmit Power Control (TPC) and power density

#### **LIMIT**

The limits below are applicable to the system as a whole and in any possible configuration. Includes smart antenna systems (devices with multiple transmit chains).

In case of multiple (adjacent or non-adjacent) channels within the same sub-band, the total RF output power of all channels in that sub-band shall not exceed the limits defined below.

In case of multiple, non-adjacent channels operating in separate sub-bands, the total RF output power in each of the sub-bands shall not exceed the limits defined below.

TPC is not required for channels whose nominal bandwidth falls completely within the band 5 150 MHz to 5 250 MHz.

For devices with TPC, the RF output power and the power density when configured to operate at the highest stated power level of the TPC range shall not exceed the levels given in table 1.

Devices are allowed to operate without TPC. See table 1 for the applicable limits in this case.



**Table 1: Mean e.i.r.p. limits for RF output power and power density at the highest power level**

Frequency range [MHz]	Mean e.i.r.p. limit [dBm]		Mean e.i.r.p. density limit [dBm/MHz]	
	with TPC	without TPC	with TPC	without TPC
5 150 to 5 350	23	20/23 (see note 1)	10	7/10 (see note 2)
5 470 to 5 725	30 (see note 3)	27 (see note 3)	17 (see note 3)	14 (see note 3)

NOTE 1: The applicable limit is 20 dBm, except for transmissions whose nominal bandwidth falls completely within the band 5 150 MHz to 5 250 MHz, in which case the applicable limit is 23 dBm.

NOTE 2: The applicable limit is 7 dBm/MHz, except for transmissions whose nominal bandwidth falls completely within the band 5 150 MHz to 5 250 MHz, in which case the applicable limit is 10 dBm/MHz.

NOTE 3: Slave devices without a Radar Interference Detection function shall comply with the limits for the band 5 250 MHz to 5 350 MHz.

For devices using TPC, the RF output power during a transmission burst when configured to operate at the lowest stated power level of the TPC range shall not exceed the levels given in table 2.  
For devices without TPC, the limits in table 2 do not apply.

**Table 2: Mean e.i.r.p. limits for RF output power at the lowest power level of the TPC range**

Frequency range	Mean e.i.r.p. [dBm]
5 250 MHz to 5 350 MHz	17
5 470 MHz to 5 725 MHz	24 (see note)

NOTE: Slave devices without a Radar Interference Detection function shall comply with the limits for the band 5 250 MHz to 5 350 MHz.

### **Test Procedure**

#### RF Output Power:

- Since a temporary antenna connector can be attached on the RF output port, so conducted measurement method was used in this case
- A wide band power meter with a matched thermocouple detector was used to directly measure the output power from the RF output port of the EUT in continuously transmitting mode
- The  $EIRP = A + G + 10 \cdot \log(1/x)$ , where A is the power measured in (a), G is the gain of the antenna of the EUT in dBi and x is the duty cycle of the EUT in continuously transmitting mode
- The measurement shall be repeated at the lowest, the middle, and the highest channel of the stated frequency range. These measurements shall also be performed at normal and ble the beamforming gain "Y" in dB, according to the formula below. This value shall be recorded in the test report. If more than one antenna assembly is intended for this power setting, the gain of the antenna assembly with the highest gain shall be used.  $PD = D + G + Y + 10 \log(1/x)$  extreme test conditions

#### Power Density

- The spectrum analyzer resolution bandwidth and video bandwidth of 5.4.4.2.1.3.2 step1 was used
- When the trace is complete, find the peak value of the power envelope and record the frequency
- The spectrum analyzer resolution bandwidth and video bandwidth of 5.4.4.2.1.3.2 step3 was used
- When the trace is complete, the trace shall be captured using the "Hold" or "View" option on the spectrum analyzer
- Find the peak value of the trace and place the analyzer marker on this peak. This level is recorded as the highest mean power (power density) D in a 1 MHz band
- Alternatively, where a spectrum analyser is equipped with a function to measure spectral power density, this function may be used to display the power density D in dBm/MHz
- In case of conducted measurements on smart antenna systems operating in a mode with multiple transmit chains active simultaneously, the power density of each transmit chain shall be measured separately to calculate the total power density (value "D" in dBm/MHz) for the UUT
- The maximum spectral power density e.i.r.p. is calculated from the above measured power density



(D), the observed duty cycle  $x$  (see clause 5.4.4.2.1.1.2 step 1), the applicable antenna assembly gain "G" in dBi and if applicable the beamforming gain "Y" in dB, according to the formula below. This value shall be recorded in the test report. If more than one antenna assembly is intended for this power setting, the gain of the antenna assembly with the highest gain shall be used.  $PD = D + G + Y + 10 \log(1/x)$ .

### **Test Results**

#### **5150-5250 Band I**

Note: Antenna A Power > Antenna B Power, Both antenna A and B have been test, 802.11a model cannot output Power at the same time. Only show the worst data of Antenna A

TEST CONDITIONS		Output power/802.11a					
		Average EIRP Power ( dBm )					
		ANT A		ANT B		ANT A+ANT B	
		5180MHz	5240MHz	5180MHz	5240MHz	5180MHz	5240MHz
T nom (°C)	V nom (V)	14.75	15.35	14.65	14.85	--	--
T min (°C)	V max (V)	14.61	15.28	14.55	14.84	--	--
	V min (V)	14.58	15.17	14.59	14.76	--	--
T max (°C)	V max (V)	14.60	15.18	14.48	14.71	--	--
	V min (V)	14.64	15.24	14.58	14.83	--	--
Max Average Power		<b>15.35dBm</b>					
Limits		23dBm					
<b>Result</b>		<b>Complies</b>					



Output power/802.11n(HT20)							
TEST CONDITIONS		Average EIRP Power ( dBm )					
		ANT A		ANT B		ANT A+ANT B	
		5180MHz	5240MHz	5180MHz	5240MHz	5180MHz	5240MHz
T nom (°C)	V nom (V)	14.55	15.25	14.45	14.55	17.51	17.92
T min (°C)	V max (V)	14.45	15.20	14.44	14.46	17.46	17.86
	V min (V)	14.47	15.07	14.42	14.55	17.46	17.83
T max (°C)	V max (V)	14.39	15.07	14.38	14.49	17.40	17.80
	V min (V)	14.43	15.23	14.26	14.53	17.36	17.90
Max Average Power		17.92dBm					
Limits		23dBm					
Result		Complies					

Output power/802.11n(HT40)							
TEST CONDITIONS		Average EIRP Power ( dBm )					
		ANT A		ANT B		ANT A+ANT B	
		5190MHz	5230MHz	5190MHz	5230MHz	5190MHz	5230MHz
T nom (°C)	V nom (V)	13.95	14.35	13.65	13.75	16.81	17.07
T min (°C)	V max (V)	13.82	14.17	13.55	13.59	16.70	16.90
	V min (V)	13.81	13.30	13.48	13.63	16.66	16.48
T max (°C)	V max (V)	13.93	14.17	13.50	13.72	16.73	16.96
	V min (V)	13.82	14.27	13.46	13.66	16.65	16.99
Max Average Power		17.07dBm					
Limits		23dBm					
Result		Complies					



Output power/802.11ac(HT20)							
TEST CONDITIONS		Average EIRP Power ( dBm )					
		ANT A		ANT B		ANT A+ANT B	
		5180MHz	5240MHz	5180MHz	5240MHz	5180MHz	5240MHz
T nom (°C)	V nom (V)	14.25	14.95	13.95	14.35	17.11	17.67
T min (°C)	V max (V)	14.22	14.79	13.93	14.31	17.09	17.57
	V min (V)	14.15	14.90	13.78	14.24	16.98	17.59
T max (°C)	V max (V)	14.20	14.89	13.81	13.29	17.02	17.17
	V min (V)	14.20	14.80	13.95	14.19	17.09	17.52
Max Average Power		17.67dBm					
Limits		23dBm					
Result		Complies					

Output power/802.11ac(HT40)							
TEST CONDITIONS		Average EIRP Power ( dBm )					
		ANT A		ANT B		ANT A+ANT B	
		5190MHz	5230MHz	5190MHz	5230MHz	5190MHz	5230MHz
T nom (°C)	V nom (V)	13.95	14.25	13.55	13.65	16.76	16.97
T min (°C)	V max (V)	13.90	14.21	13.36	13.57	16.65	16.91
	V min (V)	13.87	14.25	13.47	13.48	16.68	16.89
T max (°C)	V max (V)	13.89	14.07	13.49	13.62	16.70	16.86
	V min (V)	13.80	14.19	13.43	13.61	16.63	16.92
Max Average Power		16.97dBm					
Limits		23dBm					
Result		Complies					





Output power/802.11ac(HT80)				
TEST CONDITIONS		Average EIRP Power ( dBm )		
		ANT A	ANT B	ANT A+ANT B
		5210MHz	5210MHz	5210MHz
T nom (°C)	V nom (V)	14.15	13.55	16.87
T min (°C)	V max (V)	14.13	13.42	16.80
	V min (V)	13.97	13.48	16.74
T max (°C)	V max (V)	14.10	13.39	16.77
	V min (V)	14.09	13.52	16.82
Max Average Power		14.87dBm		
Limits		23dBm		
Result		Complies		

#### 5250-5350 Band II

Note: antenna output power Represent the value of antenna totapower (A+B)+Gain=EIRP.  
Antenna A Power> Antenna B Power, Both antenna A and B have been test,802.11a model cannot output Power at the same time.Only show the worst data of Antenna A

Output power/802.11a							
TEST CONDITIONS		Average EIRP Power ( dBm )					
		ANT A		ANT B		ANT A+ANT B	
		5260MHz	5320MHz	5260MHz	5320MHz	5260MHz	5320MHz
T nom (°C)	V nom (V)	14.65	13.55	14.05	12.75	--	--
T min (°C)	V max (V)	14.58	13.45	13.89	12.61	--	--
	V min (V)	14.52	13.43	14.01	12.65	--	--
T max (°C)	V max (V)	14.48	13.50	14.04	12.74	--	--
	V min (V)	14.55	13.49	13.98	12.62	--	--
Max Average Power		14.58dBm					
Limits		23dBm					
Result		Complies					



Output power/802.11n(HT20)							
TEST CONDITIONS		Average EIRP Power ( dBm )					
		ANT A		ANT B		ANT A+ANT B	
		5260MHz	5320MHz	5260MHz	5320MHz	5260MHz	5320MHz
T nom (°C)	V nom (V)	15.35	14.35	14.75	13.45	18.07	16.93
T min (°C)	V max (V)	15.22	15.24	14.75	13.44	18.00	17.44
	V min (V)	15.29	14.26	14.66	13.42	18.00	16.87
T max (°C)	V max (V)	15.16	14.29	14.62	13.38	17.91	16.87
	V min (V)	15.17	14.29	14.60	13.25	17.90	16.81
Max Average Power		18.07dBm					
Limits		23dBm					
Result		Complies					

Output power/802.11n(HT40)							
TEST CONDITIONS		Average EIRP Power ( dBm )					
		ANT A		ANT B		ANT A+ANT B	
		5270MHz	5310MHz	5270MHz	5310MHz	5270MHz	5310MHz
T nom (°C)	V nom (V)	14.95	14.25	14.45	13.55	7.72	16.92
T min (°C)	V max (V)	14.89	14.18	14.36	13.54	17.64	16.88
	V min (V)	14.81	14.12	14.40	13.38	17.62	16.78
T max (°C)	V max (V)	14.78	14.23	14.34	13.49	17.58	16.89
	V min (V)	14.83	14.19	14.27	13.48	17.57	16.86
Max Average Power		15.67dBm					
Limits		23dBm					
Result		Complies					



Output power/802.11ac(HT20)							
TEST CONDITIONS		Average EIRP Power ( dBm )					
		ANT A		ANT B		ANT A+ANT B	
		5260MHz	5320MHz	5260MHz	5320MHz	5260MHz	5320MHz
T nom (°C)	V nom (V)	15.25	14.25	14.65	13.35	17.97	16.83
T min (°C)	V max (V)	15.24	14.16	14.47	13.27	17.88	16.75
	V min (V)	15.23	14.12	14.49	13.22	17.89	16.70
T max (°C)	V max (V)	15.06	14.15	14.57	13.29	17.83	16.75
	V min (V)	15.13	14.14	14.54	14.24	17.86	17.20
Max Average Power		17.97dBm					
Limits		23dBm					
Result		Complies					

Output power/802.11ac(HT40)							
TEST CONDITIONS		Average EIRP Power ( dBm )					
		ANT A		ANT B		ANT A+ANT B	
		5270MHz	5310MHz	5270MHz	5310MHz	5270MHz	5310MHz
T nom (°C)	V nom (V)	14.85	14.15	14.35	13.45	17.62	16.82
T min (°C)	V max (V)	14.71	14.13	14.22	13.36	17.48	16.77
	V min (V)	14.79	14.06	14.23	13.29	17.53	16.70
T max (°C)	V max (V)	14.78	14.05	14.34	13.40	17.58	16.75
	V min (V)	14.66	14.03	13.26	13.30	17.03	16.69
Max Average Power		17.62dBm					
Limits		23dBm					
Result		Complies					



Output power/802.11ac(HT80)				
TEST CONDITIONS		Average EIRP Power ( dBm )		
		ANT A	ANT B	ANT A+ANT B
		5290MHz	5290MHz	5290MHz
T nom (°C)	V nom (V)	14.45	13.55	17.03
T min (°C)	V max (V)	14.41	13.37	16.93
	V min (V)	14.33	13.48	16.94
T max (°C)	V max (V)	14.26	13.51	16.91
	V min (V)	14.39	13.42	16.94
Max Average Power		17.03dBm		
Limits		23dBm		
Result		Complies		

**5470-5725 Band III**

Note: antenna output power Represent the value of antenna totapower (A+B)+Gain=EIRP.

Antenna A Power> Antenna B Power, Both antenna A and B have been test,802.11a model cannot output Power at the same time.Only show the worst data of Antenna A

TEST CONDITIONS		Average EIRP Power ( dBm )					
		ANT A		ANT B		ANT A+ANT B	
		5500MHz	5700MHz	5500MHz	5700MHz	5500MHz	5700MHz
T nom (°C)	V nom (V)	14.95	17.45	14.45	17.45	--	--
T min (°C)	V max (V)	14.89	17.40	14.33	17.34	--	--
	V min (V)	14.75	17.30	14.42	17.28	--	--
T max (°C)	V max (V)	14.83	17.42	14.40	17.30	--	--
	V min (V)	14.94	17.26	14.29	17.35	--	--
Max Peak Power		17.45dBm					
Limits		30dBm					
Result		Complies					



Output power/802.11n(HT20)							
TEST CONDITIONS		Average EIRP Power ( dBm )					
		ANT A		ANT B		ANT A+ANT B	
		5500MHz	5700MHz	5500MHz	5700MHz	5500MHz	5700MHz
T nom (°C)	V nom (V)	16.85	17.25	14.25	17.25	18.75	20.26
T min (°C)	V max (V)	16.67	17.12	15.16	17.09	18.99	20.12
	V min (V)	16.66	17.21	15.06	17.17	18.94	20.20
T max (°C)	V max (V)	16.81	17.09	15.15	17.15	19.07	20.13
	V min (V)	16.70	17.05	15.11	17.20	18.99	20.14
Max Peak Power		20.26dBm					
Limits		30dBm					
Result		Complies					

Output power/802.11n(HT40)							
TEST CONDITIONS		Average EIRP Power ( dBm )					
		ANT A		ANT B		ANT A+ANT B	
		5510MHz	5670MHz	5510MHz	5670MHz	5510MHz	5670MHz
T nom (°C)	V nom (V)	16.65	16.85	14.05	16.75	18.55	19.81
T min (°C)	V max (V)	16.60	16.71	13.89	16.56	18.46	19.65
	V min (V)	16.62	16.80	13.97	16.72	18.50	19.77
T max (°C)	V max (V)	16.63	16.80	13.91	16.64	18.49	19.73
	V min (V)	16.45	16.74	14.02	16.56	18.41	19.66
Max Peak Power		19.81dBm					
Limits		30dBm					
Result		Complies					



Output power/802.11ac(HT20)							
TEST CONDITIONS		Average EIRP Power ( dBm )					
		ANT A		ANT B		ANT A+ANT B	
		5500MHz	5700MHz	5500MHz	5700MHz	5500MHz	5700MHz
T nom (°C)	V nom (V)	16.75	16.95	14.15	17.15	18.65	20.06
T min (°C)	V max (V)	16.70	16.86	14.03	17.11	18.58	20.00
	V min (V)	16.74	16.91	14.06	16.96	18.61	19.95
T max (°C)	V max (V)	16.55	16.86	13.99	16.97	18.47	19.93
	V min (V)	16.68	16.85	14.07	16.95	18.58	19.91
Max Peak Power		20.06dBm					
Limits		30dBm					
Result		Complies					

Output power/802.11ac(HT40)							
TEST CONDITIONS		Average EIRP Power ( dBm )					
		ANT A		ANT B		ANT A+ANT B	
		5510MHz	5670MHz	5510MHz	5670MHz	5510MHz	5670MHz
T nom (°C)	V nom (V)	16.55	16.85	13.95	16.65	18.45	19.76
T min (°C)	V max (V)	16.38	16.76	13.87	16.62	18.31	19.70
	V min (V)	16.52	16.69	13.85	16.53	18.40	19.62
T max (°C)	V max (V)	16.41	16.76	13.84	16.53	18.32	19.66
	V min (V)	16.43	16.78	13.93	16.56	18.37	19.68
Max Peak Power		19.76dBm					
Limits		30dBm					
Result		Complies					



Output power/802.11ac(HT80)							
TEST CONDITIONS		Average EIRP Power ( dBm )					
		ANT A		ANT B		ANT A+ANT B	
		5530MHz	5610MHz	5530MHz	5610MHz	5530MHz	5610MHz
T nom (°C)	V nom (V)	16.45	16.55	13.85	15.75	18.35	19.18
T min (°C)	V max (V)	16.40	16.36	13.83	15.72	18.31	19.06
	V min (V)	16.30	16.35	13.78	15.59	18.23	19.00
T max (°C)	V max (V)	16.30	16.53	13.78	15.58	18.23	19.09
	V min (V)	16.37	16.38	13.69	15.58	18.24	19.01
Max Peak Power		19.18dBm					
Limits		30dBm					
Result		Complies					

### POWER DENSITY TEST RESULTS

Antenna A Power> Antenna B Power, Both antenna A and B have been test,802.11a model cannot output Power at the same time.Only show the worst data of Antenna A

Power density/802.11a							
TEST CONDITIONS		EIRP Spectral Power Density(dBm/MHz)					
		5180MHz			5240MHz		
		ANT A	ANT B	Total	ANT A	ANT B	Total
		dBm/MHz	dBm/MHz	dBm/MHz	dBm/MHz	dBm/MHz	dBm/MHz
Tnom(°C)	Vnom(°C)	0.75	0.74	--	2.00	1.99	--
Limits		10dBm/MHz					
Result		Complies					

Power density/802.11n(HT20)							
TEST CONDITIONS		EIRP Spectral Power Density(dBm/MHz)					
		5180MHz			5240MHz		
		ANT A	ANT B	Total	ANT A	ANT B	Total
		dBm/MHz	dBm/MHz	dBm/MHz	dBm/MHz	dBm/MHz	dBm/MHz
Tnom(°C)	Vnom(°C)	0.52	0.51	3.53	1.66	1.64	4.66
Limits		10dBm/MHz					
Result		Complies					

Power density/802.11n(HT40)							
TEST CONDITIONS		EIRP Spectral Power Density(dBm/MHz)					
		5190MHz			5230MHz		
		ANT A	ANT B	Total	ANT A	ANT B	Total



		dBm/MHz	dBm/MHz	dBm/MHz	dBm/MHz	dBm/MHz	dBm/MHz
Tnom(°C)	Vnom(°C)	-5.21	-5.22	-2.20	-4.30	-4.32	-1.30
Limits		10dBm/MHz					
Result		Complies					

Power density/802.11ac(HT20)							
TEST CONDITIONS		EIRP Spectral Power Density(dBm/MHz)					
		5180MHz			5240MHz		
		ANT A	ANT B	Total	ANT A	ANT B	Total
		dBm/MHz	dBm/MHz	dBm/MHz	dBm/MHz	dBm/MHz	dBm/MHz
Tnom(°C)	Vnom(°C)	0.62	0.60	3.62	1.62	1.60	4.62
Limits		10dBm/MHz					
Result		Complies					

Power density/802.11ac(HT40)							
TEST CONDITIONS		EIRP Spectral Power Density(dBm/MHz)					
		5190MHz			5230MHz		
		ANT A	ANT B	Total	ANT A	ANT B	Total
		dBm/MHz	dBm/MHz	dBm/MHz	dBm/MHz	dBm/MHz	dBm/MHz
Tnom(°C)	Vnom(°C)	-5.27	-5.29	-2.27	-4.31	-4.33	-1.31
Limits		10dBm/MHz					
Result		Complies					

Power density/802.11ac(HT80)				
TEST CONDITIONS		EIRP Spectral Power Density(dBm/MHz)		
		5210MHz		
		ANT A	ANT B	Total
		dBm/MHz	dBm/MHz	dBm/MHz
Tnom(°C)	Vnom(°C)	-6.71	-6.74	-3.71
Limits		10dBm/MHz		
Result		Complies		

Transmissions Level (dBm)=(Antenna A+ Antenna B)Port+G. Antenna A Power> Antenna B Power, Both antenna A and B have been test,802.11a model cannot output Power at the same time.Only show the worst data of Antenna A

Power density/802.11a							
TEST CONDITIONS		EIRP Spectral Power Density(dBm/MHz)					
		5260MHz			5320MHz		
		ANT A	ANT B	Total	ANT A	ANT B	Total
		dBm/MHz	dBm/MHz	dBm/MHz	dBm/MHz	dBm/MHz	dBm/MHz
Tnom(°C)	Vnom(°C)	-0.94	-0.98	--	0.20	0.13	--
Limits		10dBm/MHz					
Result		Complies					





Power density/802.11n(HT20)							
TEST CONDITIONS		EIRP Spectral Power Density(dBm/MHz)					
		5260MHz			5320MHz		
		ANT A	ANT B	Total	ANT A	ANT B	Total
		dBm/MHz	dBm/MHz	dBm/MHz	dBm/MHz	dBm/MHz	dBm/MHz
Tnom(°C)	Vnom(°C)	-1.30	-1.34	1.69	-0.11	-0.14	2.89
Limits		10dBm/MHz					
Result		Complies					

Power density/802.11n(HT40)							
TEST CONDITIONS		EIRP Spectral Power Density(dBm/MHz)					
		5270MHz			5310MHz		
		ANT A	ANT B	Total	ANT A	ANT B	Total
		dBm/MHz	dBm/MHz	dBm/MHz	dBm/MHz	dBm/MHz	dBm/MHz
Tnom(°C)	Vnom(°C)	-1.32	-1.36	1.67	-0.10	-0.13	2.90
Limits		10dBm/MHz					
Result		Complies					

Power density/802.11ac(HT20)							
TEST CONDITIONS		EIRP Spectral Power Density(dBm/MHz)					
		5260MHz			5320MHz		
		ANT A	ANT B	Total	ANT A	ANT B	Total
		dBm/MHz	dBm/MHz	dBm/MHz	dBm/MHz	dBm/MHz	dBm/MHz
Tnom(°C)	Vnom(°C)	-1.32	-1.36	1.67	-0.10	-0.13	2.90
Limits		10dBm/MHz					
Result		Complies					

Power density/802.11ac(HT40)							
TEST CONDITIONS		EIRP Spectral Power Density(dBm/MHz)					
		5270MHz			5310MHz		
		ANT A	ANT B	Total	ANT A	ANT B	Total
		dBm/MHz	dBm/MHz	dBm/MHz	dBm/MHz	dBm/MHz	dBm/MHz
Tnom(°C)	Vnom(°C)	-3.71	-3.73	-0.71	-2.91	-2.92	0.10
Limits		10dBm/MHz					
Result		Complies					

Power density/802.11ac(HT80)				
TEST CONDITIONS		EIRP Spectral Power Density(dBm/MHz)		
		5290MHz		
		ANT A	ANT B	Total



		dBm/MHz	dBm/MHz	dBm/MHz
Tnom(°C)	Vnom(°C)	-5.35	-5.37	-2.35
Limits		10dBm/MHz		
Result		Complies		



Transmissions Level (dBm)=(Antenna A+ Antenna B)Port+G. Antenna A Power> Antenna B Power, Both antenna A and B have been test,802.11a model cannot output Power at the same time.Only show the worst data of Antenna A

Power density/802.11a							
TEST CONDITIONS		EIRP Spectral Power Density(dBm/MHz)					
		5500MHz			5700MHz		
		ANT A	ANT B	Total	ANT A	ANT B	Total
		dBm/MHz	dBm/MHz	dBm/MHz	dBm/MHz	dBm/MHz	dBm/MHz
Tnom(°C)	Vnom(°C)	1.92	1.90	--	1.92	1.89	--
Limits		17dBm/MHz					
Result		Complies					

Power density/802.11n(HT20)							
TEST CONDITIONS		EIRP Spectral Power Density(dBm/MHz)					
		5500MHz			5700MHz		
		ANT A	ANT B	Total	ANT A	ANT B	Total
		dBm/MHz	dBm/MHz	dBm/MHz	dBm/MHz	dBm/MHz	dBm/MHz
Tnom(°C)	Vnom(°C)	1.66	1.64	4.66	1.63	1.62	3.39
Limits		17dBm/MHz					
Result		Complies					

Power density/802.11n(HT40)							
TEST CONDITIONS		EIRP Spectral Power Density(dBm/MHz)					
		5510MHz			5670MHz		
		ANT A	ANT B	Total	ANT A	ANT B	Total
		dBm/MHz	dBm/MHz	dBm/MHz	dBm/MHz	dBm/MHz	dBm/MHz
Tnom(°C)	Vnom(°C)	-1.16	-1.18	1.84	-1.47	-1.48	0.29
Limits		17dBm/MHz					
Result		Complies					

Power density/802.11ac(HT20)							
TEST CONDITIONS		EIRP Spectral Power Density(dBm/MHz)					
		5500MHz			5700MHz		
		ANT A	ANT B	Total	ANT A	ANT B	Total
		dBm/MHz	dBm/MHz	dBm/MHz	dBm/MHz	dBm/MHz	dBm/MHz
Tnom(°C)	Vnom(°C)	1.61	1.60	4.62	1.58	1.57	4.59
Limits		17dBm/MHz					
Result		Complies					

Power density/802.11ac(HT40)							
TEST CONDITIONS		EIRP Spectral Power Density(dBm/MHz)					
		5510MHz			5670MHz		
		ANT A	ANT B	Total	ANT A	ANT B	Total



		dBm/MHz	dBm/MHz	dBm/MHz	dBm/MHz	dBm/MHz	dBm/MHz
Tnom(°C)	Vnom(°C)	-1.17	-1.18	1.84	-1.16	-1.17	1.85
Limits		17dBm/MHz					
Result		Complies					

Power density/802.11ac(HT80)							
TEST CONDITIONS		EIRP Spectral Power Density(dBm/MHz)					
		5530MHz			5610MHz		
		ANT A	ANT B	Total	ANT A	ANT B	Total
		dBm/MHz	dBm/MHz	dBm/MHz	dBm/MHz	dBm/MHz	dBm/MHz
Tnom(°C)	Vnom(°C)	-3.50	-3.52	-0.50	-3.77	-3.78	-0.76
Limits		17dBm/MHz					
Result		Complies					



## 5.4. Transmitter unwanted emissions

### 5.4.1. Transmitter unwanted emissions outside the 5 GHz RLAN bands

#### Limit

The level of unwanted emission shall not exceed the limits given in table 3.

**Table 3: Transmitter unwanted emission limits outside the 5 GHz RLAN bands**

Frequency range	Maximum power	Bandwidth
30 MHz to 47 MHz	-36 dBm	100 kHz
47 MHz to 74 MHz	-54 dBm	100 kHz
74 MHz to 87,5 MHz	-36 dBm	100 kHz
87,5 MHz to 118 MHz	-54 dBm	100 kHz
118 MHz to 174 MHz	-36 dBm	100 kHz
174 MHz to 230 MHz	-54 dBm	100 kHz
230 MHz to 470 MHz	-36 dBm	100 kHz
470 MHz to 862 MHz	-54 dBm	100 kHz
862 MHz to 1 GHz	-36 dBm	100 kHz
1 GHz to 5,15 GHz	-30 dBm	1 MHz
5,35 GHz to 5,47 GHz	-30 dBm	1 MHz
5,725 GHz to 26 GHz	-30 dBm	1 MHz

#### Test Procedure

1. The measurement procedure follows ETSI EN 301 893 (V2.1.1) Sub-clause 5.4.5.2.2
2. The measurement shall only be performed at normal test conditions.  
One channel out of the declared channels for each sub-band shall be tested.

#### Test Configuration

### Effective Radiated Power measurement (30 MHz to 26 GHz)

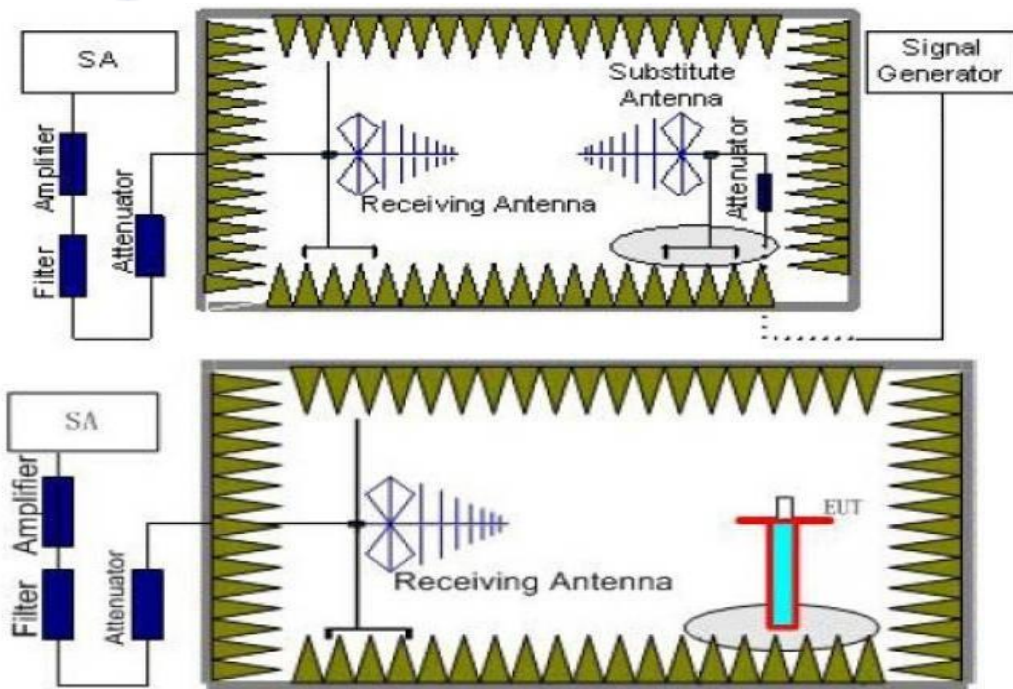

## TEST RESULTS

Note: All test modes are performed, only the worst case is recorded in this report  
Please refer the following pages..



**Band I TX 802.11 a Low**

<b>Freq(MHz)</b>	<b>RSM Level (dBm)</b>	<b>Limit (dBm)</b>	<b>Over Limit (dBm)</b>	<b>Result</b>
83.284	-72.78	-36.00	36.78	Pass
307.382	-70.51	-36.00	34.51	Pass
696.530	-72.39	-54.00	18.39	Pass
746.394	-72.42	-54.00	18.42	Pass
859.465	-72.73	-54.00	18.73	Pass
837.156	-72.65	-54.00	18.65	Pass
808.342	-72.72	-54.00	18.72	Pass

**Band II TX 802.11 a Low**

<b>Freq(MHz)</b>	<b>RSM Level (dBm)</b>	<b>Limit (dBm)</b>	<b>Over Limit (dBm)</b>	<b>Result</b>
135.854	-71.47	-36.00	35.47	Pass
287.782	-72.57	-36.00	36.57	Pass
492.345	-72.56	-54.00	18.56	Pass
564.498	-72.41	-54.00	18.41	Pass
628.378	-72.68	-54.00	18.68	Pass
769.458	-72.89	-54.00	18.89	Pass

**Band III TX 802.11 a High**

<b>Freq(MHz)</b>	<b>RSM Level (dBm)</b>	<b>Limit (dBm)</b>	<b>Over Limit (dBm)</b>	<b>Result</b>
152.376	-72.54	-36.00	36.54	Pass
299.814	-72.36	-36.00	36.36	Pass
513.685	-73.18	-54.00	19.18	Pass
598.679	-71.23	-54.00	17.23	Pass
654.316	-72.19	-54.00	18.19	Pass



722.588	-73.31	-54.00	19.31	Pass
---------	--------	--------	-------	------

**Band I TX 802.11 a Low**

<b>Freq(MHz)</b>	<b>RSM Level (dBm)</b>	<b>Limit (dBm)</b>	<b>Over Limit (dBm)</b>	<b>Result</b>
10357.00	-39.58	-30.00	9.58	Pass
10358.00	-38.30	-30.00	8.30	Pass
10359.00	-36.90	-30.00	6.90	Pass
10365.00	-39.47	-30.00	9.47	Pass
10367.00	-39.74	-30.00	9.74	Pass

**Band II TX 802.11 a Low**

<b>Freq(MHz)</b>	<b>RSM Level (dBm)</b>	<b>Limit (dBm)</b>	<b>Over Limit (dBm)</b>	<b>Result</b>
10473.00	-41.22	-30.00	11.22	Pass
10475.00	-40.34	-30.00	10.34	Pass
10480.00	-39.58	-30.00	9.58	Pass
10481.00	-39.56	-30.00	9.56	Pass
10485.00	-41.08	-30.00	11.08	Pass

**Band III TX 802.11 a High**

<b>Freq(MHz)</b>	<b>RSM Level (dBm)</b>	<b>Limit (dBm)</b>	<b>Over Limit (dBm)</b>	<b>Result</b>
10564.00	-45.00	-30.00	15.00	Pass
10579.00	-42.18	-30.00	12.18	Pass
10563.00	-39.44	-30.00	9.44	Pass
10582.00	-40.11	-30.00	10.11	Pass
10593.00	-42.06	-30.00	12.06	Pass





### 5.4.2. Transmitter unwanted emissions within the 5 GHz RLAN bands

#### LIMIT

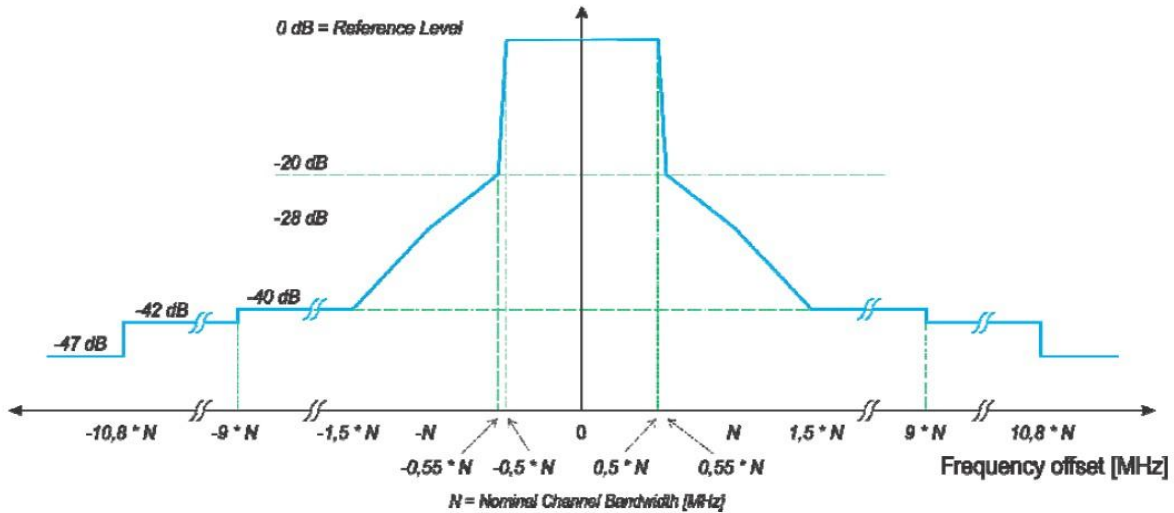

NOTE: dBc is the spectral density relative to the maximum spectral power density of the transmitted signal.

Figure 1: Transmit spectral power mask

#### Test Procedure

1. The measurement procedure follows ETSI EN 301 893 (V2.1.1) Sub-clause .4.6.2.1.
2. The measurement shall only be performed at normal test conditions.

#### Test Result

### TRANSMITTER UNWANTED EMISSIONS WITHIN THE 5 GHZ RLAN BANDS

Note: Antenna A Power > Antenna B Power, Both antenna A and B have been test, 802.11a model cannot output Power at the same time. Only show the worst data of Antenna A

802.11a

#### 802.11a CH36(Antenna A)

#### 802.11a CH40(Antenna A)

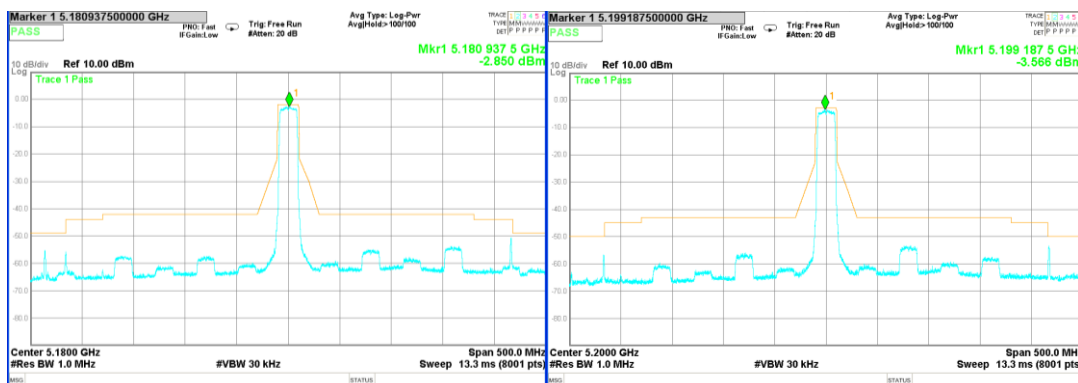

#### 802.11a CH48(Antenna A)

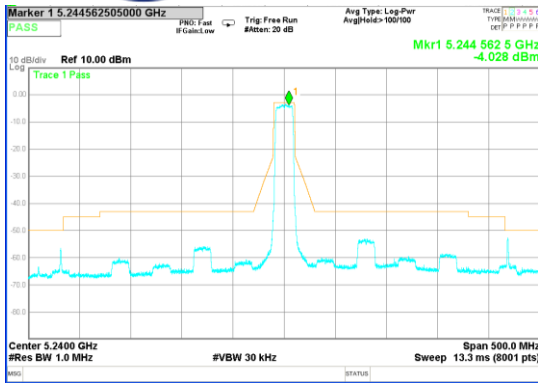

802.11n(HT20)

802.11n CH36(Antenna A)

802.11n CH40(Antenna A)

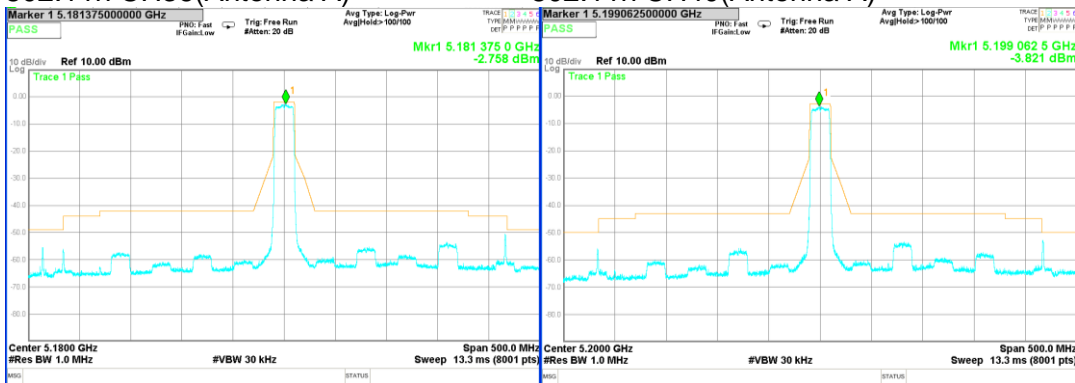

802.11n CH48(Antenna A)

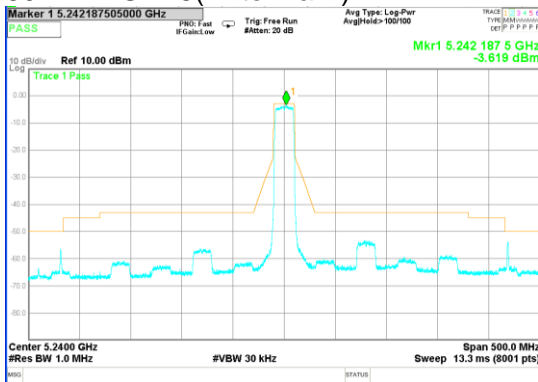



802.11n(HT40)

802.11n CH38(Antenna A)

802.11n CH46(Antenna A)

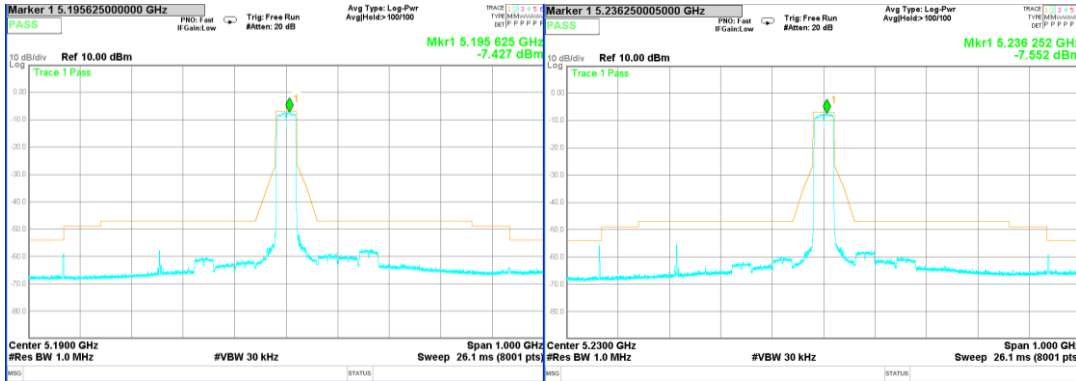

802.11ac(HT20)

802.11ac CH36(Antenna A)

802.11ac CH40(Antenna A)

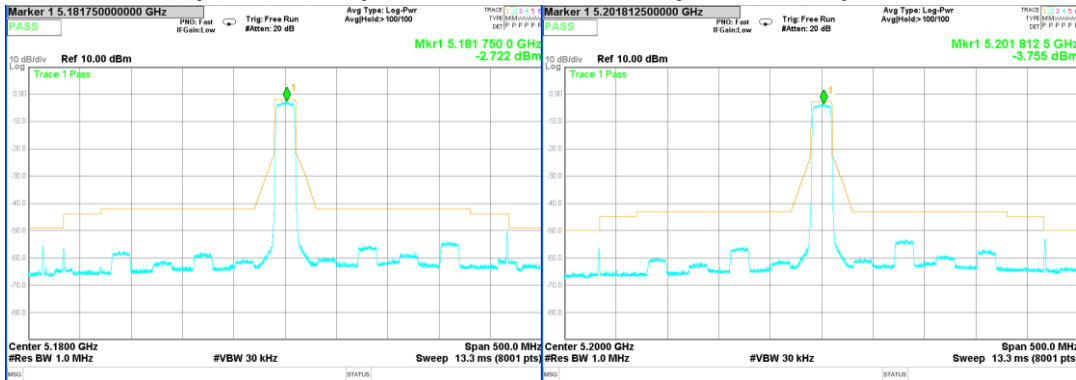

802.11ac CH48(Antenna A)

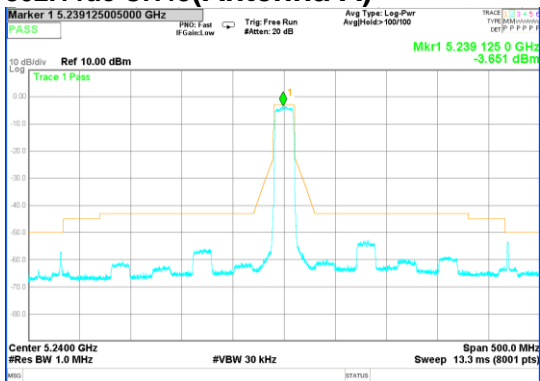



802.11ac(HT40)

802.11ac CH38(Antenna A)

802.11ac CH46(Antenna A)

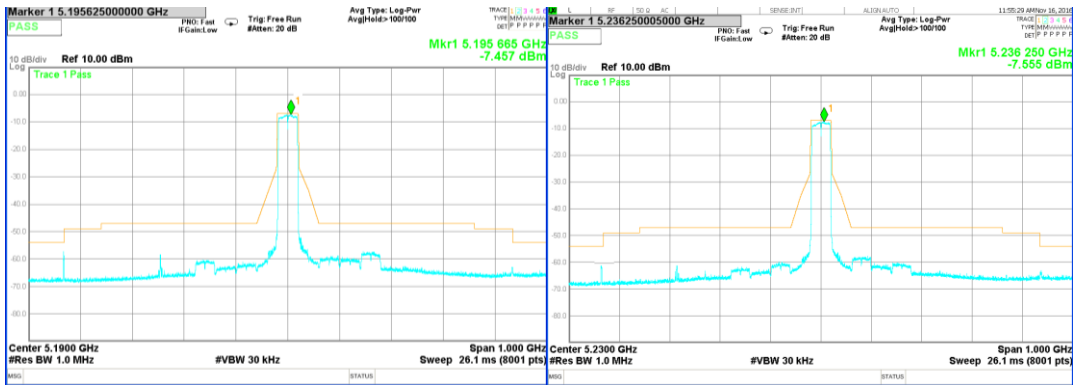

802.11ac(HT80)

802.11ac CH42(Antenna A)

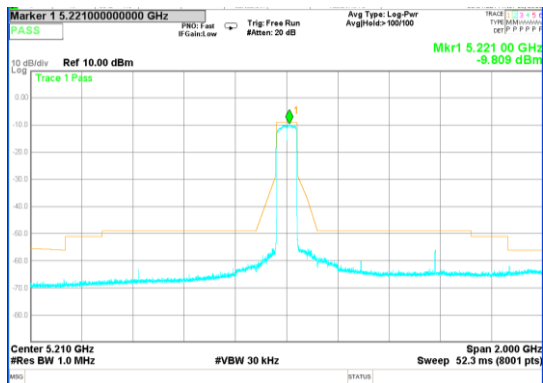

- NOTE: 1. Transmissions Level (dBm) = (Antenna A) Port. Antenna A Power > Antenna B Power > Antenna C Power  
2. Antenna A and B, C have been test, only provides the worst Antenna of A plot.



802.11a

802.11a CH52(Antenna A)

802.11a CH60(Antenna A)

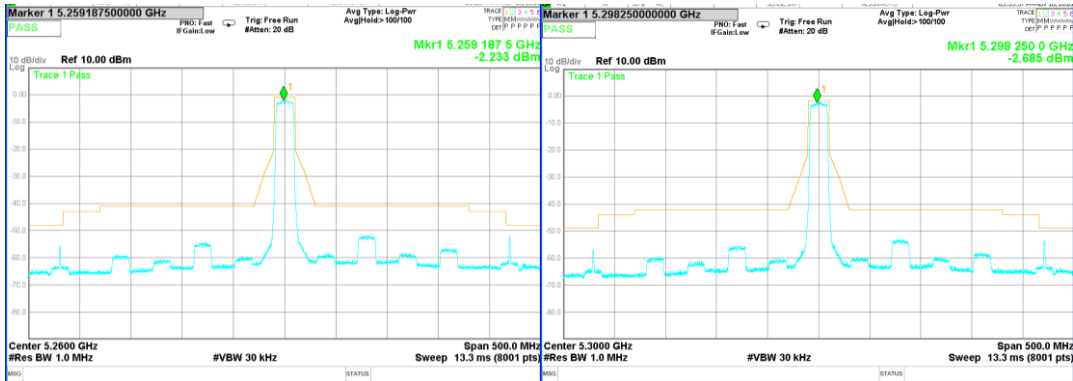

802.11a CH64(Antenna A)

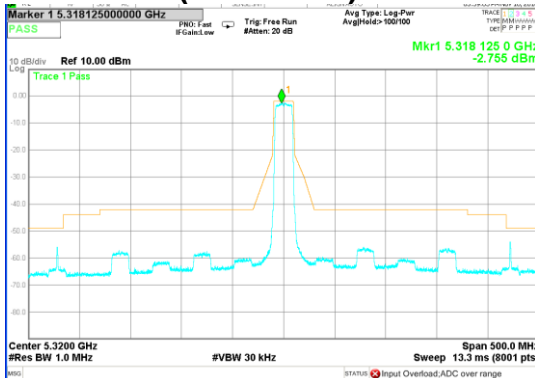

802.11n(HT20)

802.11n CH52(Antenna A)

802.11n CH60(Antenna A)

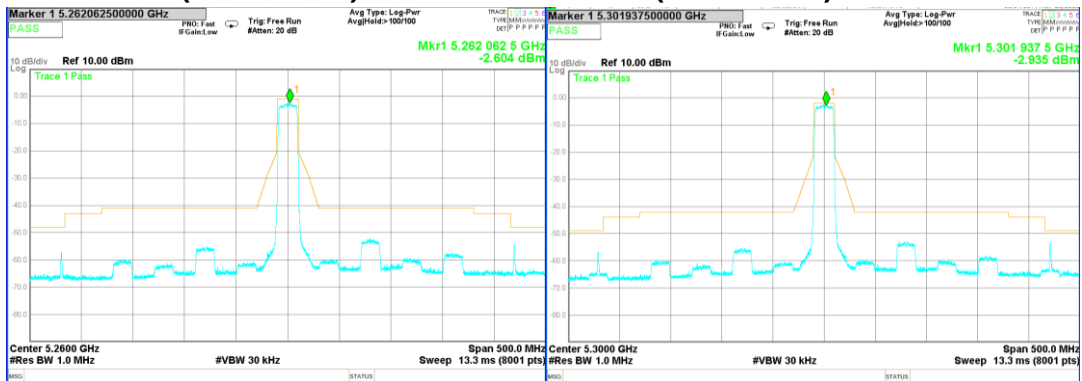



### 802.11n CH64(Antenna A)

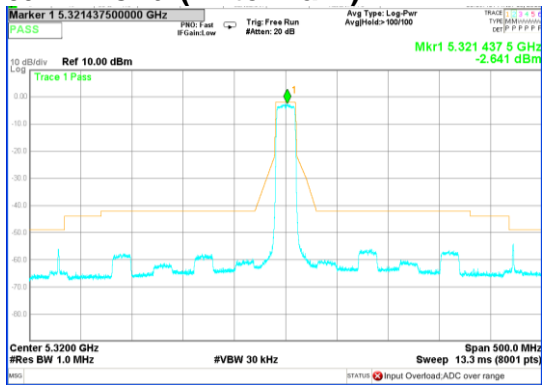



802.11n(HT40)

802.11n CH54(Antenna A)

802.11n CH62(Antenna A)

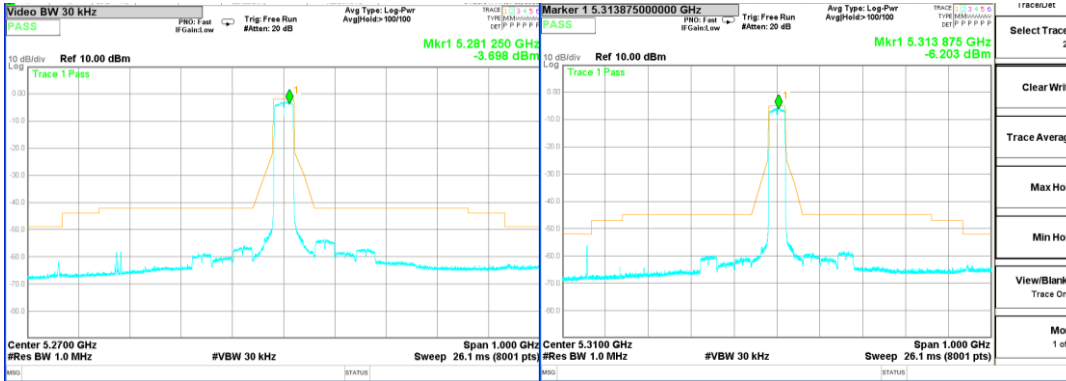

802.11ac(HT20)

802.11ac CH52(Antenna A)

802.11ac CH60(Antenna A)

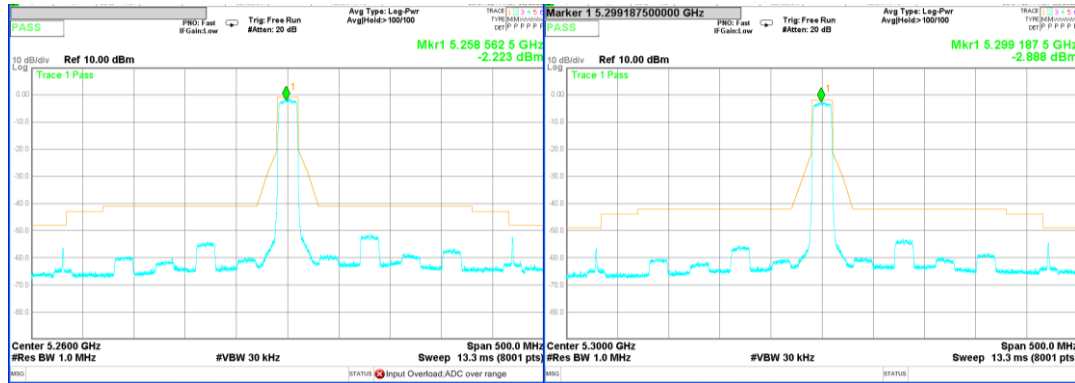

802.11ac CH64(Antenna A)

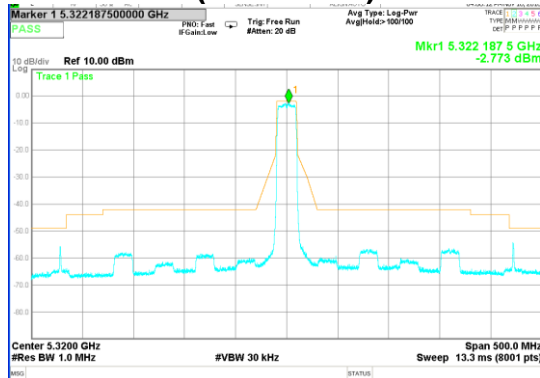



802.11ac(HT40)

802.11ac CH54(Antenna A)

802.11ac CH62(Antenna A)

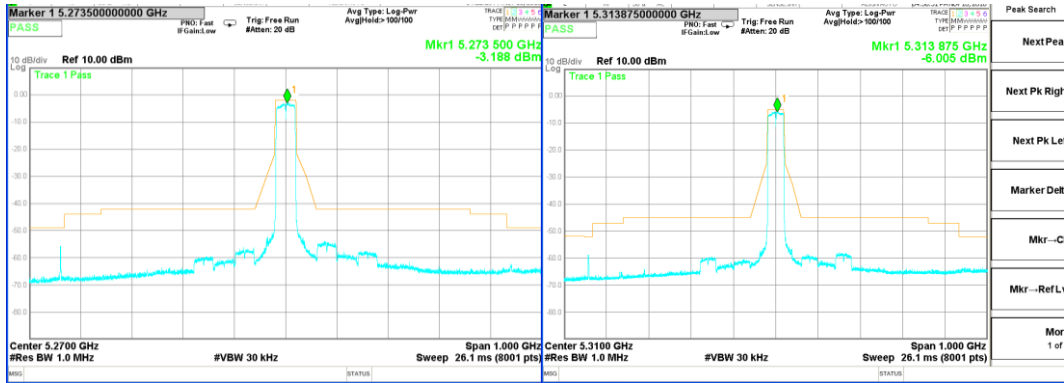

802.11ac(HT80)

802.11ac CH58(Antenna A)

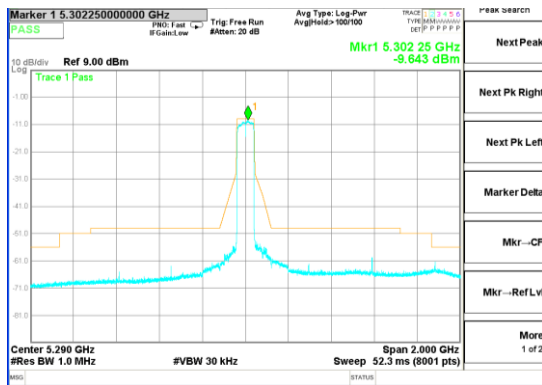

NOTE: 1. Transmissions Level (dBm)=(Antenna A) Port. Antenna A Power> Antenna B Power> Antenna C Power  
2. Antenna A and B,C have been test, only provides the worst Antenna of A plot.





802.11a

802.11a CH100(Antenna A)      802.11a CH116(Antenna A)

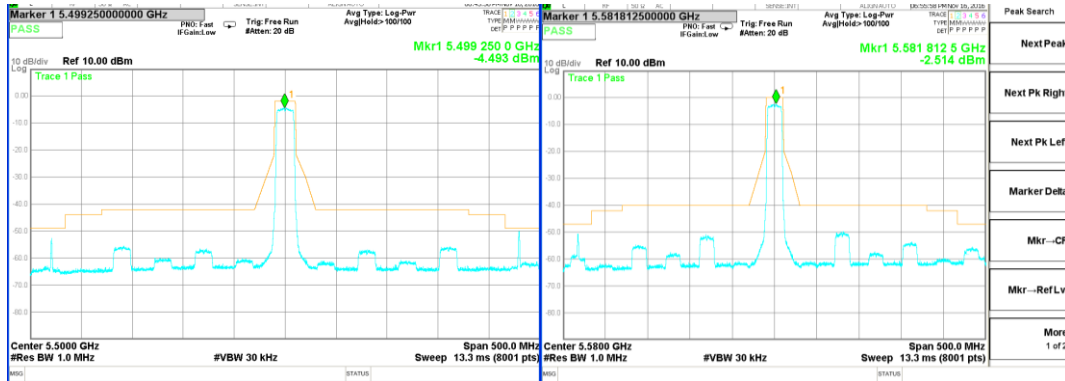

802.11a CH140(Antenna A)

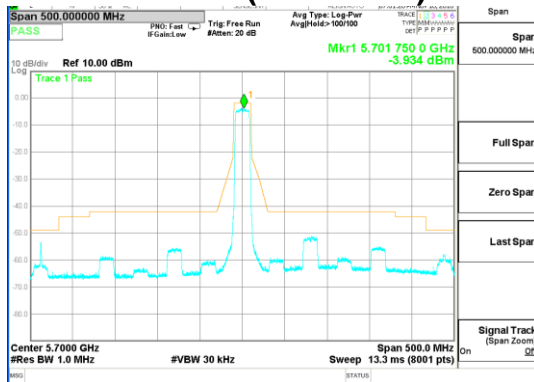

802.11n(HT20)

802.11n CH102(Antenna A)      802.11n CH116(Antenna A)

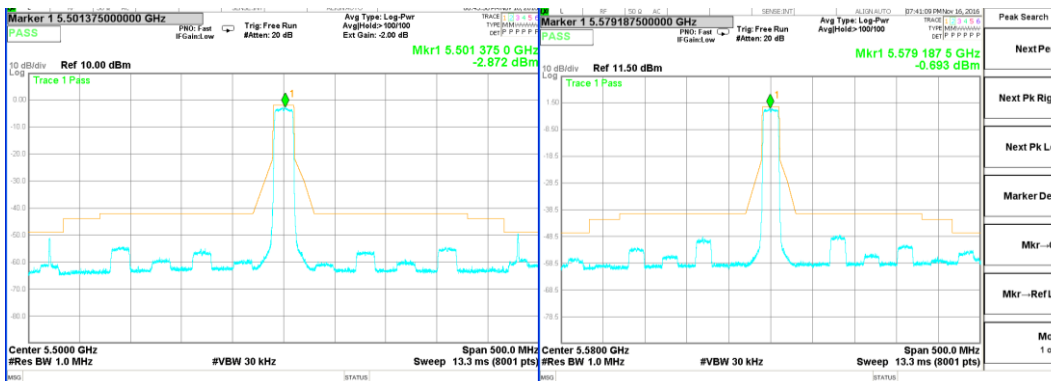

802.11n CH140(Antenna A)

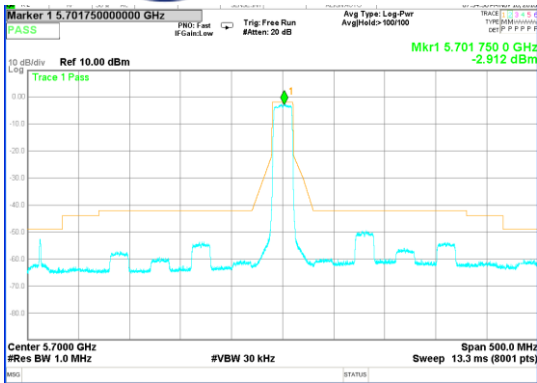

802.11n(HT40)

802.11n CH102(Antenna A)

802.11n CH110(Antenna A)

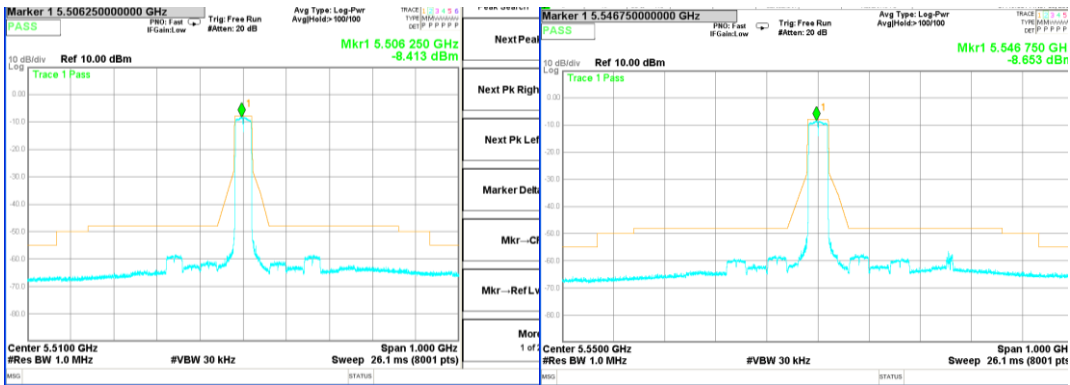

802.11n CH134(Antenna A)

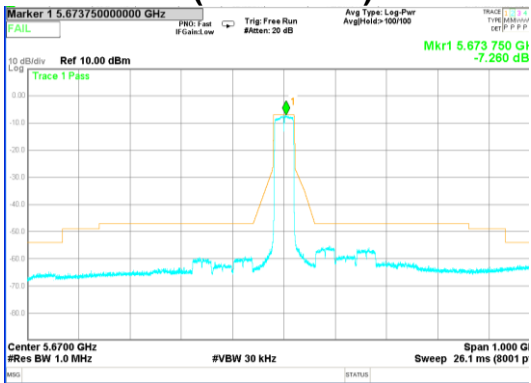



802.11ac(HT20)

802.11ac CH100(Antenna A)

802.11ac CH116(Antenna A)

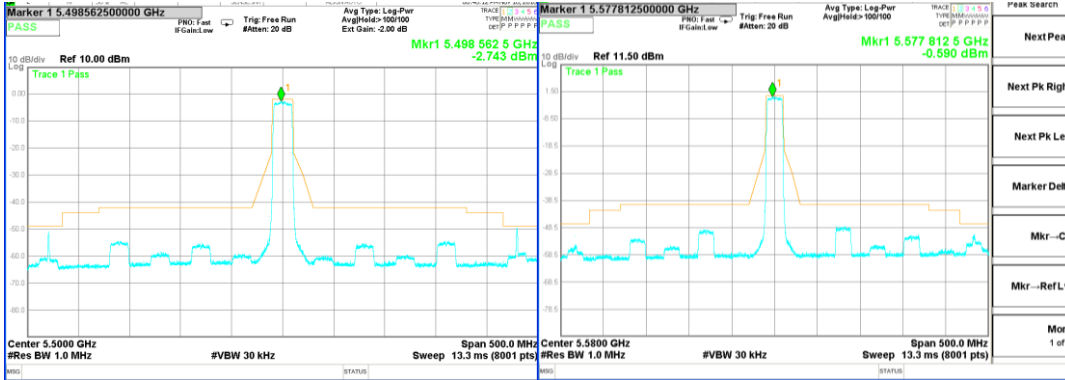

802.11ac CH140(Antenna A)

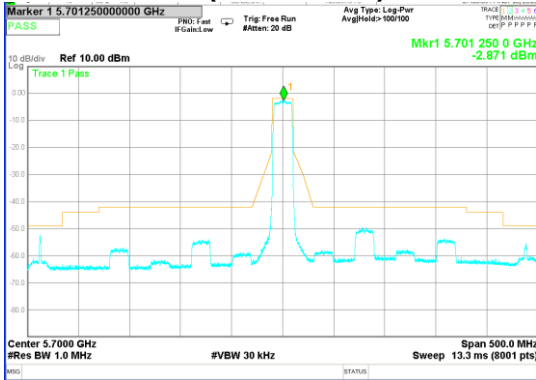

802.11ac(HT40)

802.11ac CH102(Antenna A)

802.11ac CH110(Antenna A)

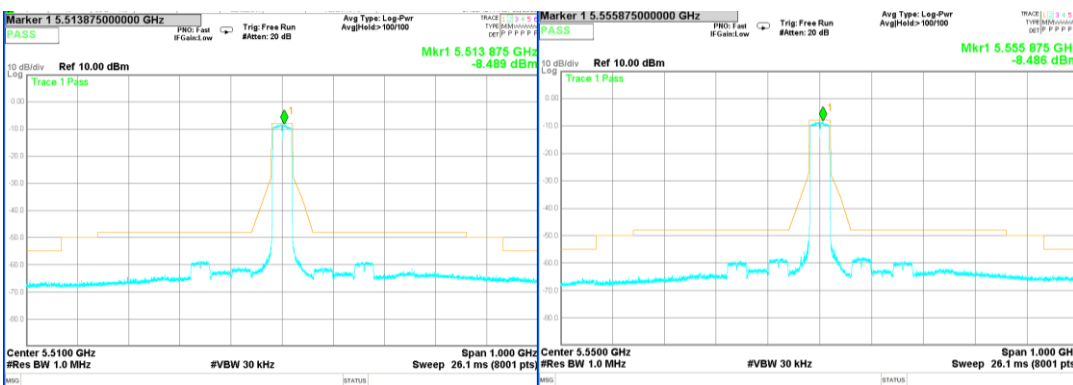

802.11ac CH134(Antenna A)

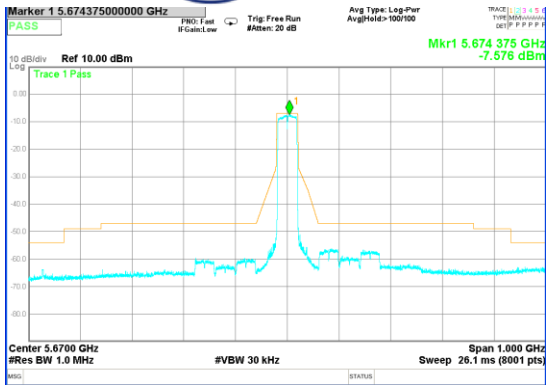



802.11ac(HT80)

802.11ac CH106(Antenna A)

802.11ac CH122(Antenna A)

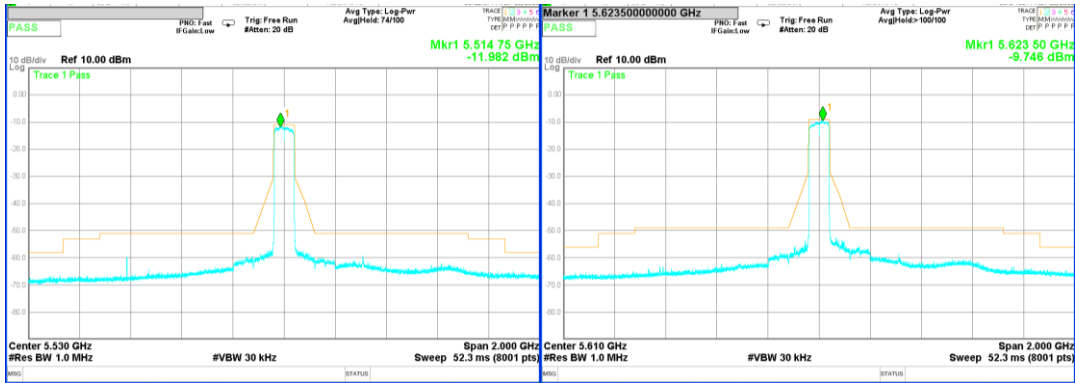

802.11ac CH138(Antenna A)

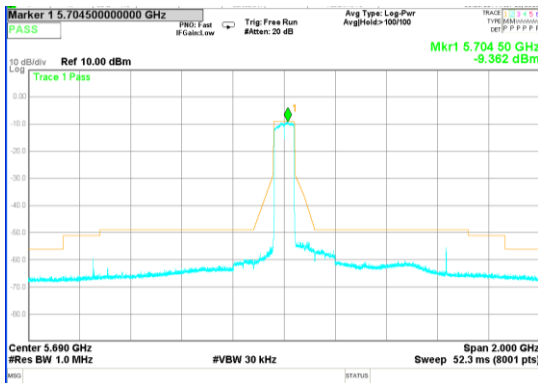

### 5.5. Receiver spurious emissions

The spurious emissions of the receiver shall not exceed the limits given in table 4.

**Table 4: Spurious radiated emission limits**

Frequency range	Maximum power	Measurement bandwidth
30 MHz to 1 GHz	-57 dBm	100 kHz
1 GHz to 26 GHz	-47 dBm	1 MHz

#### Test Procedure

1. The measurement procedure follows ETSI EN 301 893 (V2.1.1) Sub-clause 5.4.7.2.2
2. The measurement shall only be performed at normal test conditions.
3. One channel out of the declared channels for each sub-band shall be tested.

#### Test Configuration

#### Effective Radiated Power measurement (30 MHz to 26 GHz)

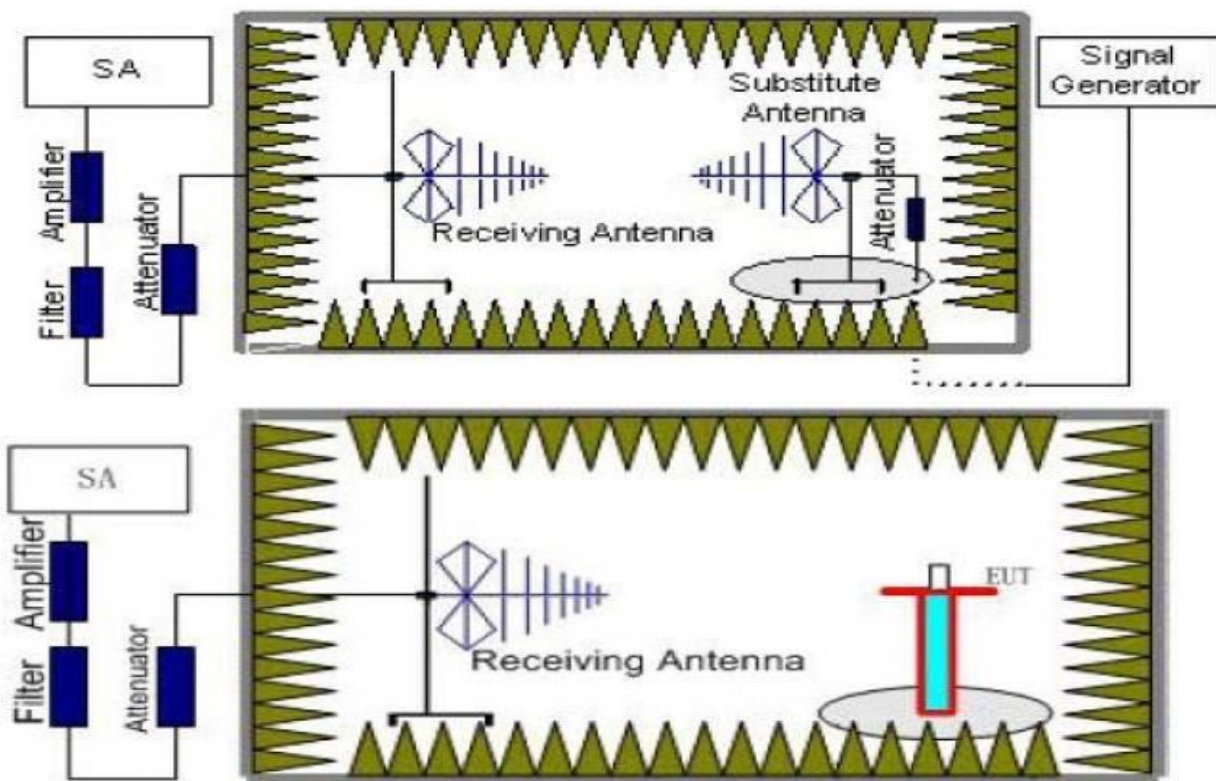



### **TEST RESULTS**

Note: All test modes are performed, only the worst case is recorded in this report  
Please refer the following pages..

#### **Band I 802.11a**

<b>Freq(MHz)</b>	<b>RSM Level (dBm)</b>	<b>Limit (dBm)</b>	<b>Over Limit (dBm)</b>	<b>Result</b>
56.958	-72.76	-57.00	15.76	Pass
239.502	-73.48	-57.00	16.48	Pass
328.545	-72.52	-57.00	15.52	Pass
489.658	-72.68	-57.00	15.68	Pass
836.153	-72.89	-57.00	15.89	Pass
889.744	-72.97	-57.00	15.97	Pass
923.647	-72.49	-57.00	15.49	Pass

#### **Band II 802.11a**

<b>Freq(MHz)</b>	<b>RSM Level (dBm)</b>	<b>Limit (dBm)</b>	<b>Over Limit (dBm)</b>	<b>Result</b>
71.365	-72.42	-57.00	15.42	Pass
776.254	-71.60	-57.00	14.60	Pass
321.583	-71.51	-57.00	14.51	Pass
456.387	-72.55	-57.00	15.55	Pass
586.312	-72.79	-57.00	15.79	Pass
793.258	-72.43	-57.00	15.43	Pass

#### **Band III 802.11a**

<b>Freq(MHz)</b>	<b>RSM Level (dBm)</b>	<b>Limit (dBm)</b>	<b>Over Limit (dBm)</b>	<b>Result</b>
85.674	-73.42	-57.00	16.42	Pass
812.317	-72.78	-57.00	15.78	Pass



368.944	-72.41	-57.00	15.41	Pass
512.428	-71.55	-57.00	14.55	Pass
614.851	-73.58	-57.00	16.58	Pass
813.697	-71.87	-57.00	14.871	Pass

**Band I 802.11a**

<b>Freq(MHz)</b>	<b>RSM Level (dBm)</b>	<b>Limit (dBm)</b>	<b>Over Limit (dBm)</b>	<b>Result</b>
1956.953	-72.62	-47.00	25.62	Pass
3548.675	-71.59	-47.00	24.59	Pass
4247.362	-72.71	-47.00	25.71	Pass
10469.126	-71.63	-47.00	24.63	Pass
10916.298	-71.78	-47.00	24.78	Pass
12558.231	-73.69	-47.00	26.69	Pass
13663.784	-72.31	-47.00	25.31	Pass

**Band II 802.11a**

<b>Freq(MHz)</b>	<b>RSM Level (dBm)</b>	<b>Limit (dBm)</b>	<b>Over Limit (dBm)</b>	<b>Result</b>
2025.346	-71.97	-47.00	24.97	Pass
3379.315	-71.15	-47.00	24.15	Pass
4167.482	-72.37	-47.00	25.37	Pass
10538.214	-72.55	-47.00	25.55	Pass
10820.649	-72.46	-47.00	25.46	Pass
11284.107	-72.72	-47.00	25.72	Pass

**Band III 802.11a**

<b>Freq(MHz)</b>	<b>RSM Level (dBm)</b>	<b>Limit (dBm)</b>	<b>Over Limit (dBm)</b>	<b>Result</b>
2365.374	-72.20	-47.00	25.20	Pass





3612.587	-71.18	-47.00	24.18	Pass
4356.948	-72.361	-47.00	25.361	Pass
10845.671	-72.47	-47.00	25.47	Pass
10964.563	-72.51	-47.00	25.51	Pass
11694.512	-72.34	-47.00	25.34	Pass



## 5.6. Dynamic Frequency Selection (DFS)

### DFS parameters

**Table D.1: DFS requirement values**

Parameter	Value
Channel Availability Check Time	60 s (see note 1)
Minimum Off-Channel CAC Time	6 minutes (see note 2)
Maximum Off-Channel CAC Time	4 hours (see note 2)
Channel Move Time	10 s
Channel Closing Transmission Time	1 s
Non-Occupancy Period	30 minutes
NOTE 1: For channels whose nominal bandwidth falls completely or partly within the band 5 600 MHz to 5 650 MHz, the <i>Channel Availability Check Time</i> shall be 10 minutes.	
NOTE 2: For channels whose nominal bandwidth falls completely or partly within the band 5 600 MHz to 5 650 MHz, the <i>Off-Channel CAC Time</i> shall be within the range 1 to 24 hours.	

**Table D.2: Interference threshold values**

e.i.r.p. Spectral Density dBm/MHz	Value (see notes 1 and 2)
10	-62 dBm
NOTE 1: This is the level at the input of the receiver of an RLAN device with a maximum e.i.r.p. density of 10 dBm/MHz and assuming a 0 dBi receive antenna. For devices employing different e.i.r.p. spectral density and/or a different receive antenna gain G (dBi) the DFS threshold level at the receiver input follows the following relationship: $\text{DFS Detection Threshold (dBm)} = -62 + 10 \cdot \text{e.i.r.p. Spectral Density (dBm/MHz)} + G \text{ (dBi)}$ however the DFS threshold level shall not be lower than -64 dBm assuming a 0 dBi receive antenna gain.	
NOTE 2: Slave devices with a maximum e.i.r.p. of less than 23 dBm do not have to implement radar detection.	

**Table D.3: Parameters of the reference DFS test signal**

Pulse width W [μs]	Pulse repetition frequency PRF [PPS]	Pulses per burst [PPB]
1	700	18



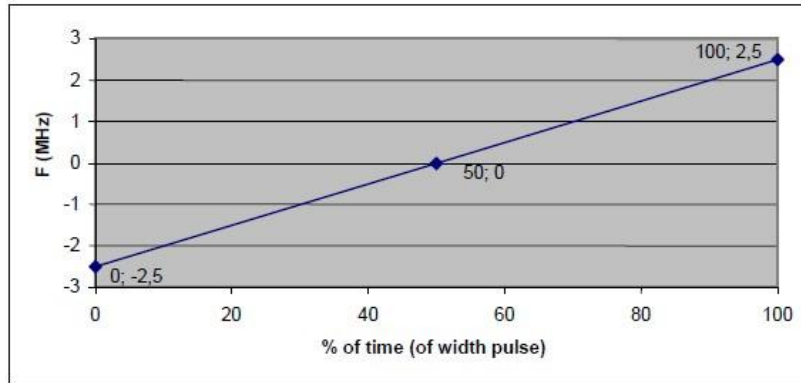

**Table D.4: Parameters of radar test signals**

Radar test signal # (see notes 1 to 3)	Pulse width W [ $\mu$ s]		Pulse repetition frequency PRF (PPS)		Number of different PRFs	Pulses per burst for each PRF (PPB) (see note 5)
	Min	Max	Min	Max		
1	0,5	5	200	1 000	1	10 (see note 6)
2	0,5	15	200	1 600	1	15 (see note 6)
3	0,5	15	2 300	4 000	1	25
4	20	30	2 000	4 000	1	20
5	0,5	2	300	400	2/3	10 (see note 6)
6	0,5	2	400	1 200	2/3	15 (see note 6)

NOTE 1: Radar test signals 1 to 4 are constant PRF based signals. See figure D.1. These radar test signals are intended to simulate also radars using a packet based Staggered PRF. See figure D.2.

NOTE 2: Radar test signal 4 is a modulated radar test signal. The modulation to be used is a chirp modulation with a  $\pm 2,5$  MHz frequency deviation which is described below.



NOTE 3: Radar test signals 5 and 6 are single pulse based Staggered PRF radar test signals using 2 or 3 different PRF values. For radar test signal 5, the difference between the PRF values chosen shall be between 20 PPS and 50 PPS. For radar test signal 6, the difference between the PRF values chosen shall be between 80 PPS and 400 PPS. See figure D.3.

NOTE 4: Apart for the Off-Channel CAC testing, the radar test signals above shall only contain a single burst of pulses. See figures D.1, D.3 and D.4. For the Off-Channel CAC testing, repetitive bursts shall be used for the total duration of the test. See figures D.2 and D.5. See also clauses 4.7.2.2, 5.3.8.2.1.3.1 and 5.3.8.2.1.3.2.

NOTE 5: The total number of pulses in a burst is equal to the number of pulses for a single PRF multiplied by the number of different PRFs used.

NOTE 6: For the CAC and Off-Channel CAC requirements, the minimum number of pulses (for each PRF) for any of the radar test signals to be detected in the band 5 600 MHz to 5 650 MHz shall be 18.

**Table D.5: Detection probability**

Parameter	Detection Probability ( $P_d$ )	
	Channels whose nominal bandwidth falls partly or completely within the 5 600 MHz to 5 650 MHz band	Other channels
CAC, Off-Channel CAC	99,99 %	60 %
In-Service Monitoring	60 %	60 %

NOTE:  $P_d$  gives the probability of detection per simulated radar burst and represents a minimum level of detection performance under defined conditions. Therefore  $P_d$  does not represent the overall detection probability for any particular radar under real life conditions.



**Test set-ups**

**Set-up A**

Set-up A is a set-up whereby the UUT is an RLAN device operating in master mode. Radar test signals are injected into the UUT. This set-up also contains an RLAN device operating in slave mode which is associated with the UUT.

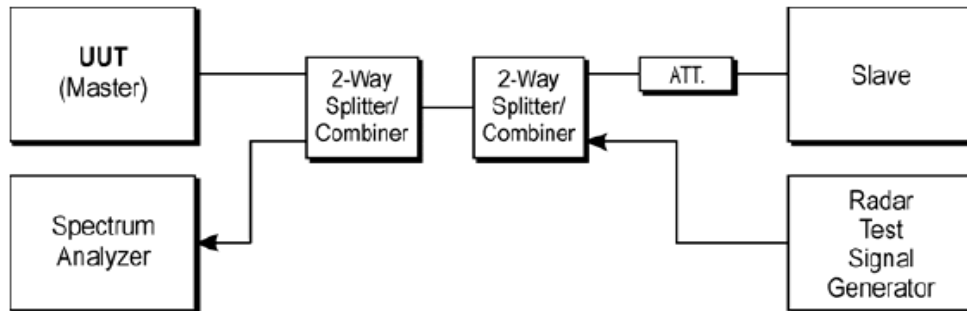

**Figure 4: Set-up A**

**Set-up B**

Set-up B is a set-up whereby the UUT is an RLAN device operating in slave mode, with or without Radar Interference Detection function. This set-up also contains an RLAN device operating in master mode. The radar test signals are injected into the master device. The UUT (slave device) is associated with the master device.

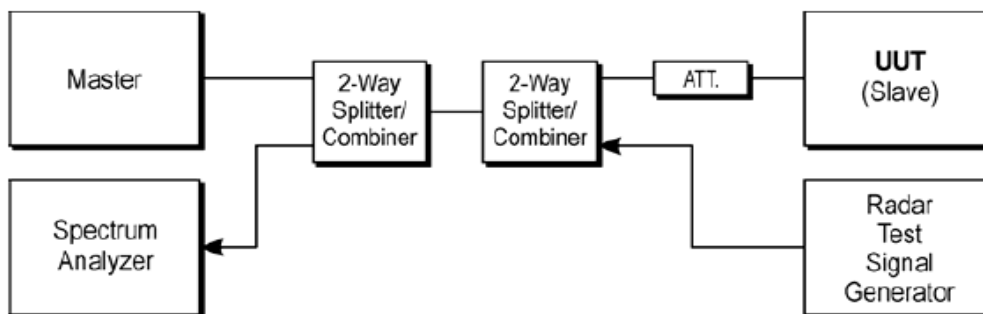

**Figure 5: Set-up B**

**Set-up C**

The UUT is an RLAN device operating in slave mode with Radar Interference Detection function. Radar test signals are injected into the slave device. This set-up also contains an RLAN device operating in master mode. The UUT (slave device) is associated with the master device.

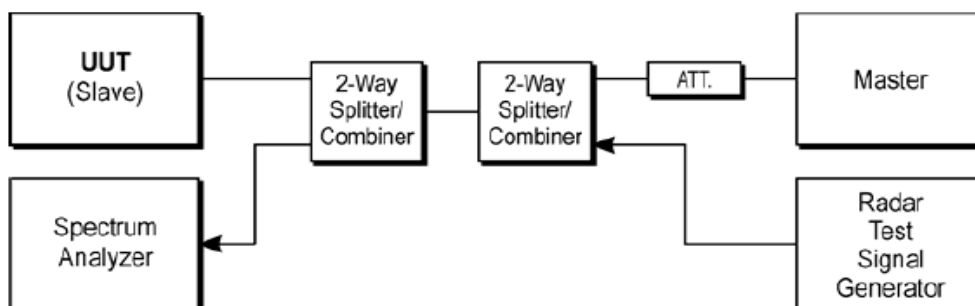

**Figure 6: Set-up C**



**DFS technical requirements specifications**

Follow table lists the DFS related technical requirements and their applicability for every operational mode. If the RLAN device is capable of operating in more than one operational mode then every operating mode shall be assessed separately.

**Applicability of DFS requirements**

Requirement	DFS Operational mode		
	Master	Slave without radar detection	Slave with radar detection (see table D.2, note 2)
Channel Availability Check	✓	Not required	✓ (see note 2)
Off-Channel CAC (see note 1)	✓	Not required	✓ (see note 2)
In-Service Monitoring	✓	Not required	✓
Channel Shutdown	✓	✓	✓
Non-Occupancy Period	✓	Not required	✓
Uniform Spreading	✓	Not required	Not required
NOTE 1: Where implemented by the manufacturer.			
NOTE 2: A slave with radar detection is not required to perform a CAC or Off-Channel CAC at initial use of the channel but only after the slave has detected a radar signal on the Operating Channel by In-Service Monitoring.			

**TEST RESULTS**

No non-compliance noted

Test plot

<u>Master Throughput</u>
--------------------------





Slave Throughput

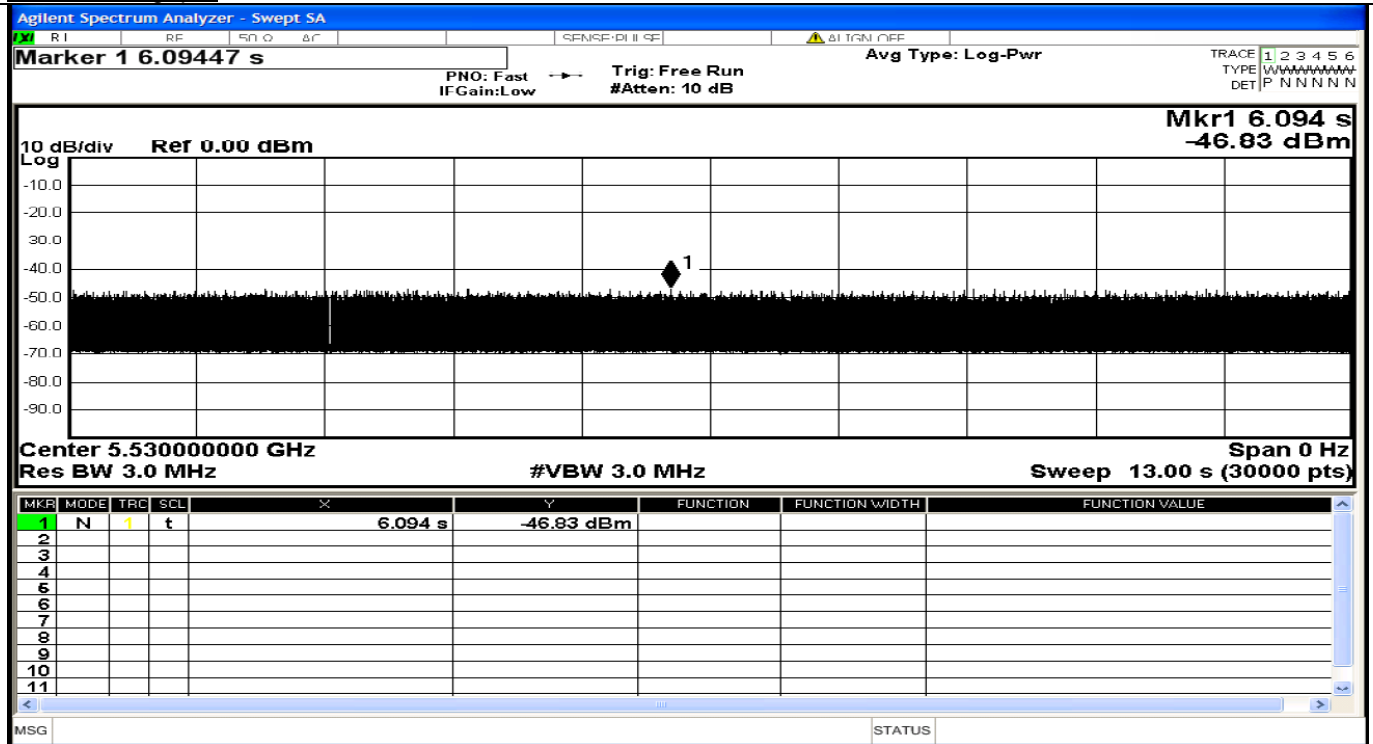

No Throughput



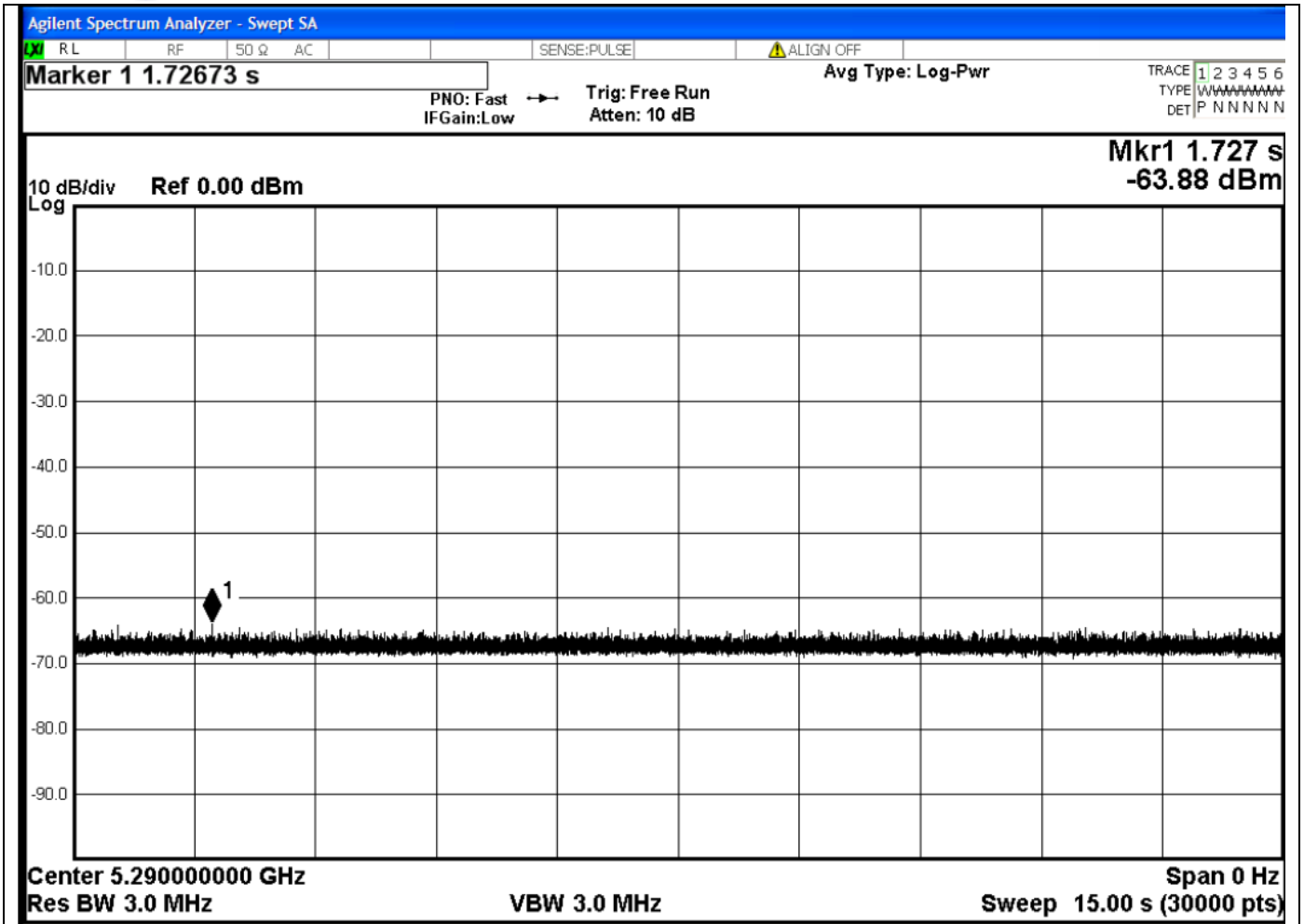

PLOTS OF RADAR WAVEFORMS



### Sample of Short Pulse Radar Type 1

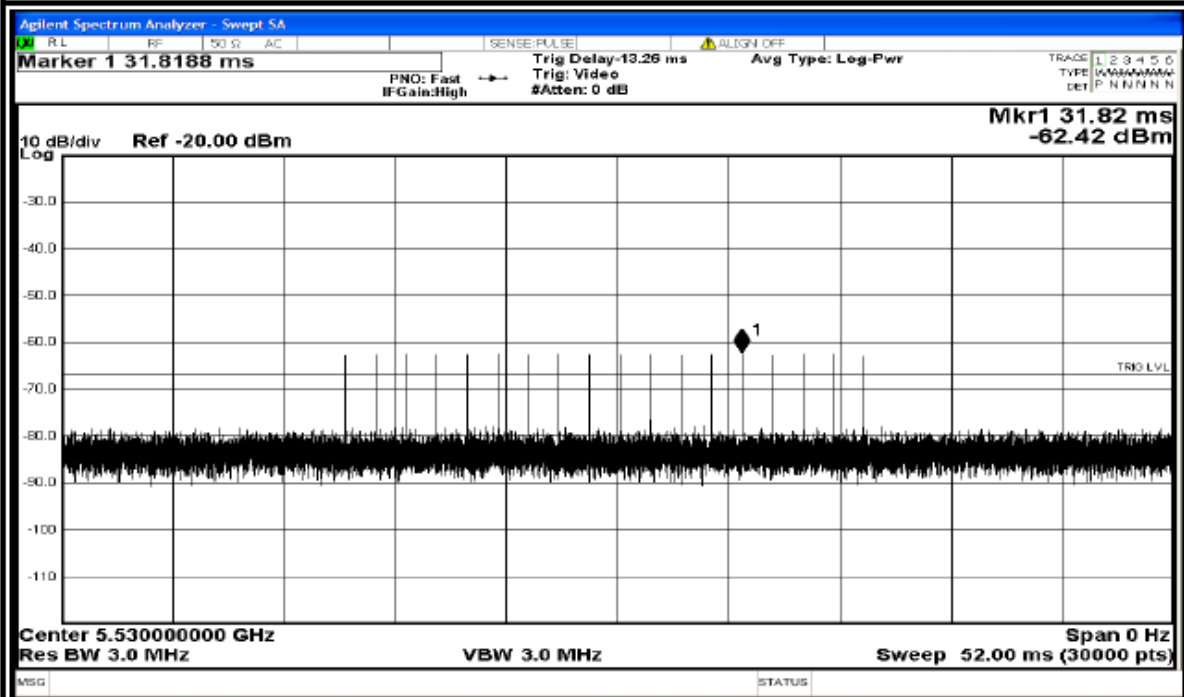

	Trial Id	Radar Type	Pulse Width (us)	PRI (us)	Number of Pulses	Waveform Length (us)
Download	0	Type 0	1.0	1428.0	18	25704.0
Download	1	Type 0	1.0	1428.0	18	25704.0
Download	2	Type 0	1.0	1428.0	18	25704.0
Download	3	Type 0	1.0	1428.0	18	25704.0
Download	4	Type 0	1.0	1428.0	18	25704.0
Download	5	Type 0	1.0	1428.0	18	25704.0
Download	6	Type 0	1.0	1428.0	18	25704.0
Download	7	Type 0	1.0	1428.0	18	25704.0
Download	8	Type 0	1.0	1428.0	18	25704.0
Download	9	Type 0	1.0	1428.0	18	25704.0
Download	10	Type 0	1.0	1428.0	18	25704.0
Download	11	Type 0	1.0	1428.0	18	25704.0
Download	12	Type 0	1.0	1428.0	18	25704.0
Download	13	Type 0	1.0	1428.0	18	25704.0
Download	14	Type 0	1.0	1428.0	18	25704.0
Download	15	Type 0	1.0	1428.0	18	25704.0
Download	16	Type 0	1.0	1428.0	18	25704.0
Download	17	Type 0	1.0	1428.0	18	25704.0
Download	18	Type 0	1.0	1428.0	18	25704.0
Download	19	Type 0	1.0	1428.0	18	25704.0
Download	20	Type 0	1.0	1428.0	18	25704.0
Download	21	Type 0	1.0	1428.0	18	25704.0
Download	22	Type 0	1.0	1428.0	18	25704.0
Download	23	Type 0	1.0	1428.0	18	25704.0
Download	24	Type 0	1.0	1428.0	18	25704.0
Download	25	Type 0	1.0	1428.0	18	25704.0
Download	26	Type 0	1.0	1428.0	18	25704.0
Download	27	Type 0	1.0	1428.0	18	25704.0
Download	28	Type 0	1.0	1428.0	18	25704.0
Download	29	Type 0	1.0	1428.0	18	25704.0



### Sample of Short Pulse Radar Type 2

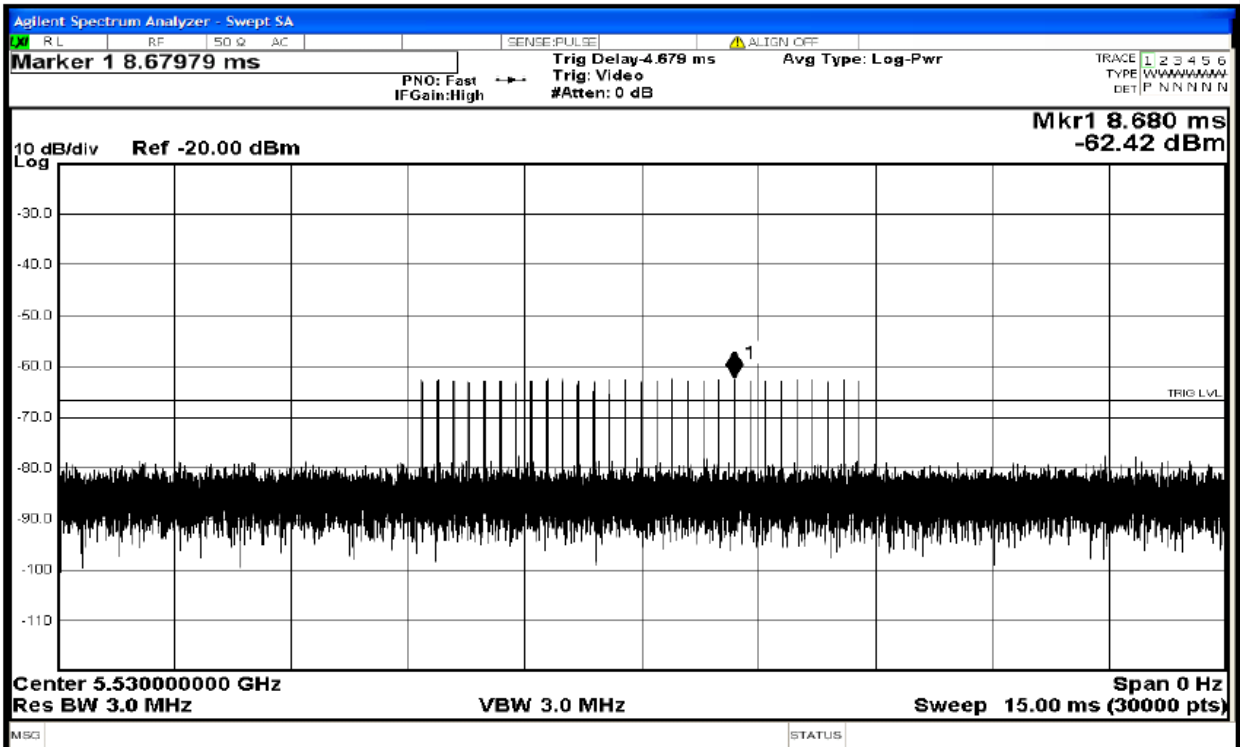

	Trial Id	Radar Type	Pulse Width (us)	PRI (us)	Number of Pulses	Waveform Length (us)
Download	0	Type 2	3.2	179.0	26	4654.0
Download	1	Type 2	1.1	207.0	23	4761.0
Download	2	Type 2	2.1	230.0	24	5520.0
Download	3	Type 2	4.8	200.0	29	5800.0
Download	4	Type 2	3.9	214.0	28	5992.0
Download	5	Type 2	2.9	222.0	26	5772.0
Download	6	Type 2	3.2	204.0	26	5304.0
Download	7	Type 2	2.5	192.0	25	4800.0
Download	8	Type 2	3.1	164.0	26	4264.0
Download	9	Type 2	1.2	156.0	23	3588.0
Download	10	Type 2	3.9	210.0	27	5670.0
Download	11	Type 2	4.6	201.0	29	5829.0
Download	12	Type 2	3.2	162.0	26	4212.0
Download	13	Type 2	2.2	197.0	25	4925.0
Download	14	Type 2	4.5	163.0	29	4727.0
Download	15	Type 2	3.0	203.0	26	5278.0
Download	16	Type 2	5.0	168.0	29	4872.0
Download	17	Type 2	2.4	217.0	25	5425.0
Download	18	Type 2	2.9	191.0	26	4966.0
Download	19	Type 2	2.3	166.0	25	4150.0
Download	20	Type 2	3.7	150.0	27	4050.0
Download	21	Type 2	2.2	176.0	25	4400.0
Download	22	Type 2	4.9	195.0	29	5655.0
Download	23	Type 2	2.9	202.0	26	5252.0
Download	24	Type 2	2.5	178.0	25	4450.0
Download	25	Type 2	1.1	206.0	23	4738.0
Download	26	Type 2	3.8	155.0	27	4185.0
Download	27	Type 2	4.7	157.0	29	4553.0
Download	28	Type 2	2.4	224.0	25	5600.0
Download	29	Type 2	4.2	159.0	28	4452.0





### Sample of Short Pulse Radar Type 3

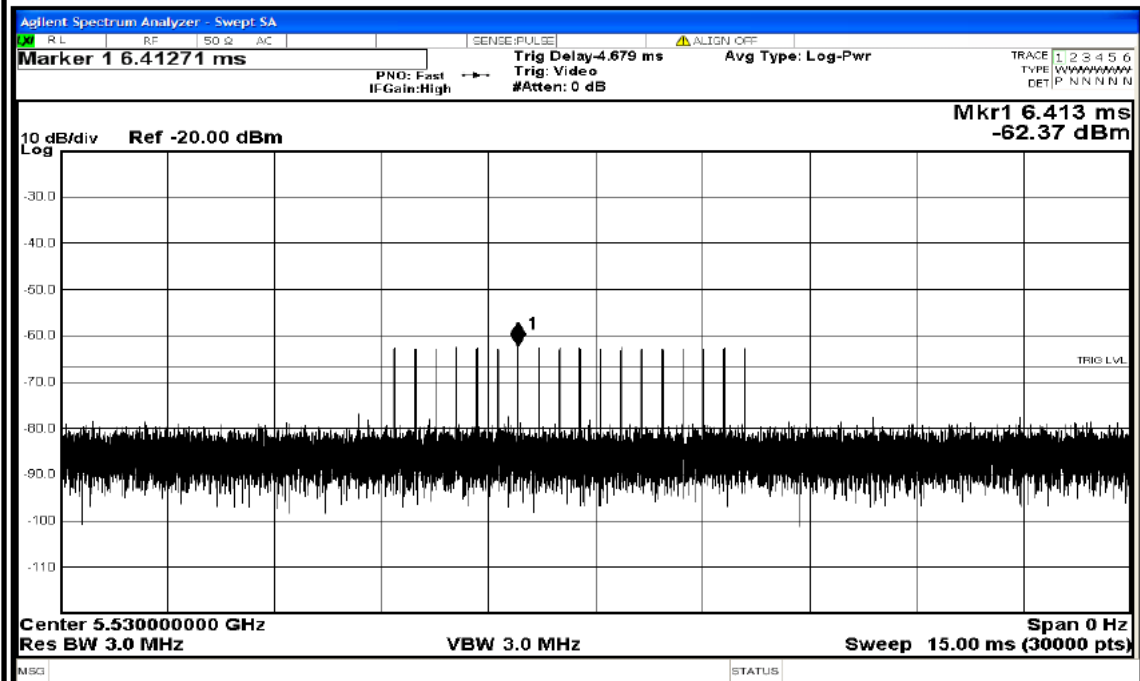

	Trial Id	Radar Type	Pulse Width (us)	PRI (us)	Number of Pulses	Waveform Length (us)
Download	0	Type 3	8.2	355.0	17	6035.0
Download	1	Type 3	6.1	487.0	16	7792.0
Download	2	Type 3	7.1	344.0	16	5504.0
Download	3	Type 3	9.8	288.0	18	5184.0
Download	4	Type 3	8.9	230.0	18	4140.0
Download	5	Type 3	7.9	432.0	17	7344.0
Download	6	Type 3	8.2	207.0	17	3519.0
Download	7	Type 3	7.5	443.0	17	7531.0
Download	8	Type 3	8.1	439.0	17	7463.0
Download	9	Type 3	6.2	223.0	16	3568.0
Download	10	Type 3	8.9	208.0	18	3744.0
Download	11	Type 3	9.6	463.0	18	8334.0
Download	12	Type 3	8.2	441.0	17	7497.0
Download	13	Type 3	7.2	323.0	16	5168.0
Download	14	Type 3	9.5	297.0	18	5346.0
Download	15	Type 3	8.0	412.0	17	7004.0
Download	16	Type 3	10.0	324.0	18	5832.0
Download	17	Type 3	7.4	271.0	17	4607.0
Download	18	Type 3	7.9	349.0	17	5933.0
Download	19	Type 3	7.3	409.0	16	6544.0
Download	20	Type 3	8.7	373.0	18	6714.0
Download	21	Type 3	7.2	254.0	16	4064.0
Download	22	Type 3	9.9	274.0	18	4932.0
Download	23	Type 3	7.9	278.0	17	4726.0
Download	24	Type 3	7.5	317.0	17	5389.0
Download	25	Type 3	6.1	260.0	16	4160.0
Download	26	Type 3	8.8	211.0	18	3798.0
Download	27	Type 3	9.7	272.0	18	4896.0
Download	28	Type 3	7.4	264.0	17	4488.0
Download	29	Type 3	9.2	284.0	18	5112.0



### Sample of Short Pulse Radar Type 4

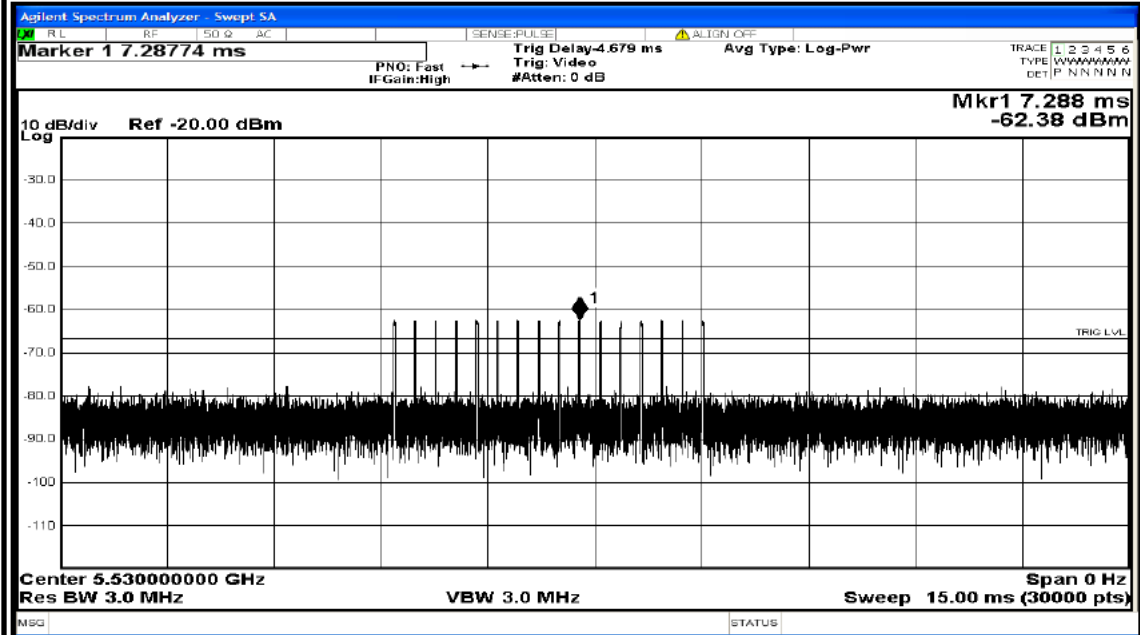

	Trial Id	Radar Type	Pulse Width (us)	PRI (us)	Number of Pulses	Waveform Length (us)
Download	0	Type 4	16.0	355.0	14	4970.0
Download	1	Type 4	11.3	487.0	12	5844.0
Download	2	Type 4	13.5	344.0	13	4472.0
Download	3	Type 4	19.4	288.0	16	4608.0
Download	4	Type 4	17.5	230.0	15	3450.0
Download	5	Type 4	15.3	432.0	14	6048.0
Download	6	Type 4	15.9	207.0	14	2898.0
Download	7	Type 4	14.3	443.0	13	5759.0
Download	8	Type 4	15.8	439.0	14	6146.0
Download	9	Type 4	11.5	223.0	12	2676.0
Download	10	Type 4	17.4	208.0	15	3120.0
Download	11	Type 4	19.0	463.0	16	7408.0
Download	12	Type 4	16.0	441.0	14	6174.0
Download	13	Type 4	13.8	323.0	13	4199.0
Download	14	Type 4	18.9	297.0	16	4752.0
Download	15	Type 4	15.5	412.0	14	5768.0
Download	16	Type 4	19.9	324.0	16	5184.0
Download	17	Type 4	14.1	271.0	13	3523.0
Download	18	Type 4	15.2	349.0	14	4886.0
Download	19	Type 4	13.8	409.0	13	5317.0
Download	20	Type 4	17.1	373.0	15	5595.0
Download	21	Type 4	13.8	254.0	13	3302.0
Download	22	Type 4	19.8	274.0	16	4384.0
Download	23	Type 4	15.3	278.0	14	3892.0
Download	24	Type 4	14.5	317.0	13	4121.0
Download	25	Type 4	11.3	260.0	12	3120.0
Download	26	Type 4	17.3	211.0	15	3165.0
Download	27	Type 4	19.2	272.0	16	4352.0
Download	28	Type 4	14.2	264.0	13	3432.0
Download	29	Type 4	18.2	284.0	15	4260.0





### Sample of Long Pulse Radar Type 5

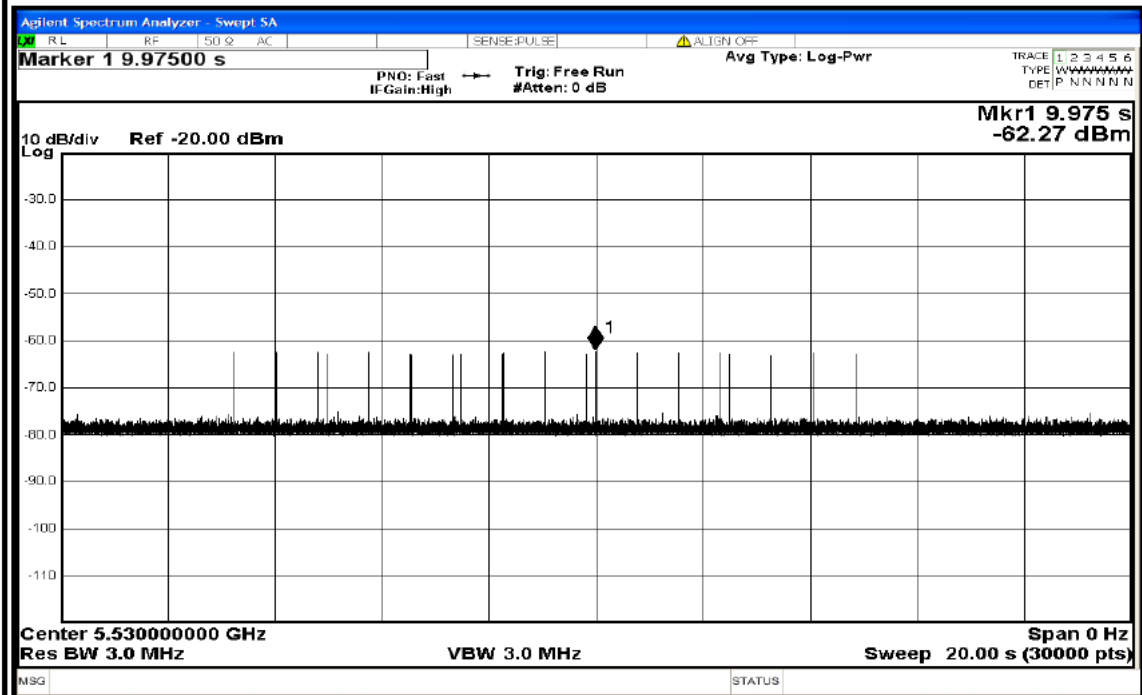

	Trial Id	Radar Type	Number of Bursts	Burst Period (s)	Waveform Length (s)	Center Frequency (GHz)
Download	0	Type 5	15	0.8000000	12.0000000	5.500000000
Download	1	Type 5	8	1.5000000	12.0000000	5.500000000
Download	2	Type 5	11	1.0909091	12.0000000	5.500000000
Download	3	Type 5	20	0.6000000	12.0000000	5.500000000
Download	4	Type 5	17	0.7058824	12.0000000	5.500000000
Download	5	Type 5	14	0.8571429	12.0000000	5.500000000
Download	6	Type 5	15	0.8000000	12.0000000	5.500000000
Download	7	Type 5	12	1.0000000	12.0000000	5.500000000
Download	8	Type 5	14	0.8571429	12.0000000	5.500000000
Download	9	Type 5	8	1.5000000	12.0000000	5.500000000
Download	10	Type 5	17	0.7058824	12.0000000	5.503900000
Download	11	Type 5	19	0.6315789	12.0000000	5.505100000
Download	12	Type 5	15	0.8000000	12.0000000	5.502700000
Download	13	Type 5	12	1.0000000	12.0000000	5.501500000
Download	14	Type 5	19	0.6315789	12.0000000	5.504700000
Download	15	Type 5	14	0.8571429	12.0000000	5.502300000
Download	16	Type 5	20	0.6000000	12.0000000	5.505500000
Download	17	Type 5	12	1.0000000	12.0000000	5.501500000
Download	18	Type 5	14	0.8571429	12.0000000	5.502300000
Download	19	Type 5	12	1.0000000	12.0000000	5.501500000
Download	20	Type 5	16	0.7500000	12.0000000	5.496500000
Download	21	Type 5	12	1.0000000	12.0000000	5.498900000
Download	22	Type 5	20	0.6000000	12.0000000	5.494500000
Download	23	Type 5	14	0.8571429	12.0000000	5.497700000
Download	24	Type 5	13	0.9230769	12.0000000	5.498100000
Download	25	Type 5	8	1.5000000	12.0000000	5.500500000
Download	26	Type 5	17	0.7058824	12.0000000	5.496100000
Download	27	Type 5	19	0.6315789	12.0000000	5.494900000
Download	28	Type 5	12	1.0000000	12.0000000	5.498500000
Download	29	Type 5	18	0.6666667	12.0000000	5.495700000





### Sample of Frequency Hopping Radar Type 6

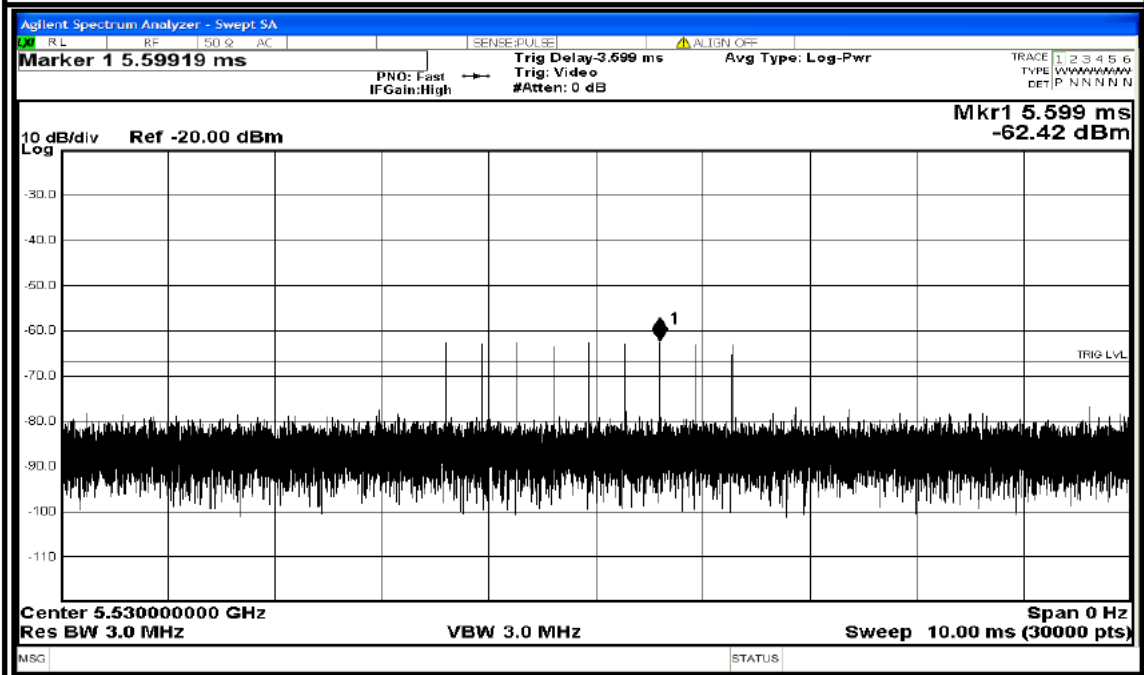

	Trial Id	Radar Type	Pulse Width (us)	PRI (us)	Pulses per Hop	Hopping Rate (kHz)	Hopping Sequence Length (ms)	Visible Frequency Number
Download	0	Type 6	1.0	333.3	9	0.3333	300.0000000	32
Download	1	Type 6	1.0	333.3	9	0.3333	300.0000000	27
Download	2	Type 6	1.0	333.3	9	0.3333	300.0000000	25
Download	3	Type 6	1.0	333.3	9	0.3333	300.0000000	33
Download	4	Type 6	1.0	333.3	9	0.3333	300.0000000	37
Download	5	Type 6	1.0	333.3	9	0.3333	300.0000000	30
Download	6	Type 6	1.0	333.3	9	0.3333	300.0000000	33
Download	7	Type 6	1.0	333.3	9	0.3333	300.0000000	27
Download	8	Type 6	1.0	333.3	9	0.3333	300.0000000	33
Download	9	Type 6	1.0	333.3	9	0.3333	300.0000000	30
Download	10	Type 6	1.0	333.3	9	0.3333	300.0000000	37
Download	11	Type 6	1.0	333.3	9	0.3333	300.0000000	36
Download	12	Type 6	1.0	333.3	9	0.3333	300.0000000	38
Download	13	Type 6	1.0	333.3	9	0.3333	300.0000000	35
Download	14	Type 6	1.0	333.3	9	0.3333	300.0000000	28
Download	15	Type 6	1.0	333.3	9	0.3333	300.0000000	37
Download	16	Type 6	1.0	333.3	9	0.3333	300.0000000	35
Download	17	Type 6	1.0	333.3	9	0.3333	300.0000000	37
Download	18	Type 6	1.0	333.3	9	0.3333	300.0000000	27
Download	19	Type 6	1.0	333.3	9	0.3333	300.0000000	34
Download	20	Type 6	1.0	333.3	9	0.3333	300.0000000	35
Download	21	Type 6	1.0	333.3	9	0.3333	300.0000000	37
Download	22	Type 6	1.0	333.3	9	0.3333	300.0000000	41
Download	23	Type 6	1.0	333.3	9	0.3333	300.0000000	36
Download	24	Type 6	1.0	333.3	9	0.3333	300.0000000	29
Download	25	Type 6	1.0	333.3	9	0.3333	300.0000000	32
Download	26	Type 6	1.0	333.3	9	0.3333	300.0000000	30
Download	27	Type 6	1.0	333.3	9	0.3333	300.0000000	31
Download	28	Type 6	1.0	333.3	9	0.3333	300.0000000	31
Download	29	Type 6	1.0	333.3	9	0.3333	300.0000000	40





Channel Closing Transmission Time Results

No non-compliance noted.

Transmission After200(ms)	AggregateTransmission Time(ms)	Limit for Aggregate Transmission TimeAfter 200 (ms)	Result
Yes	6.00	60	PASS

Only intermittent transmissions are observed during the aggregate monitoring period.

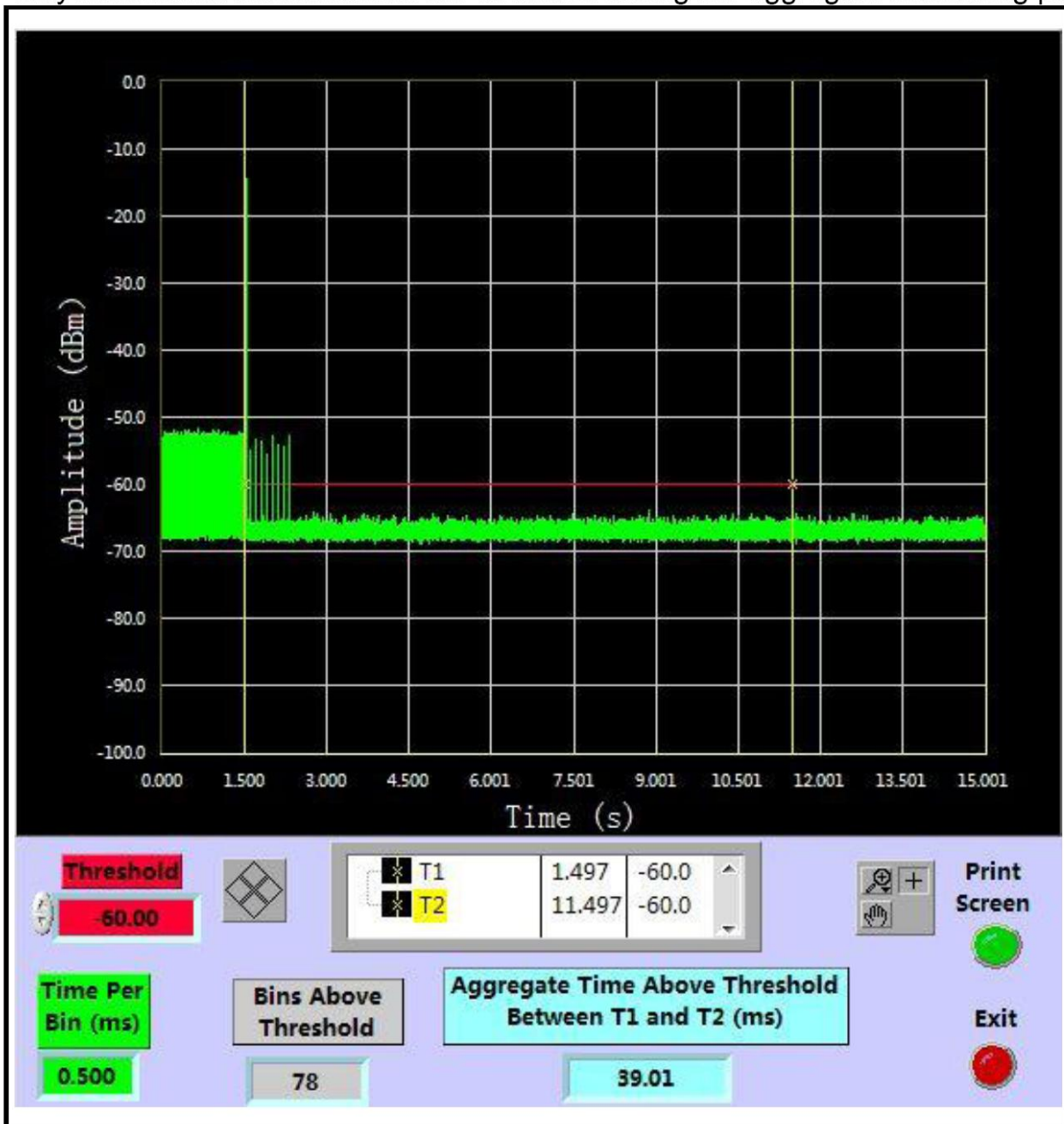

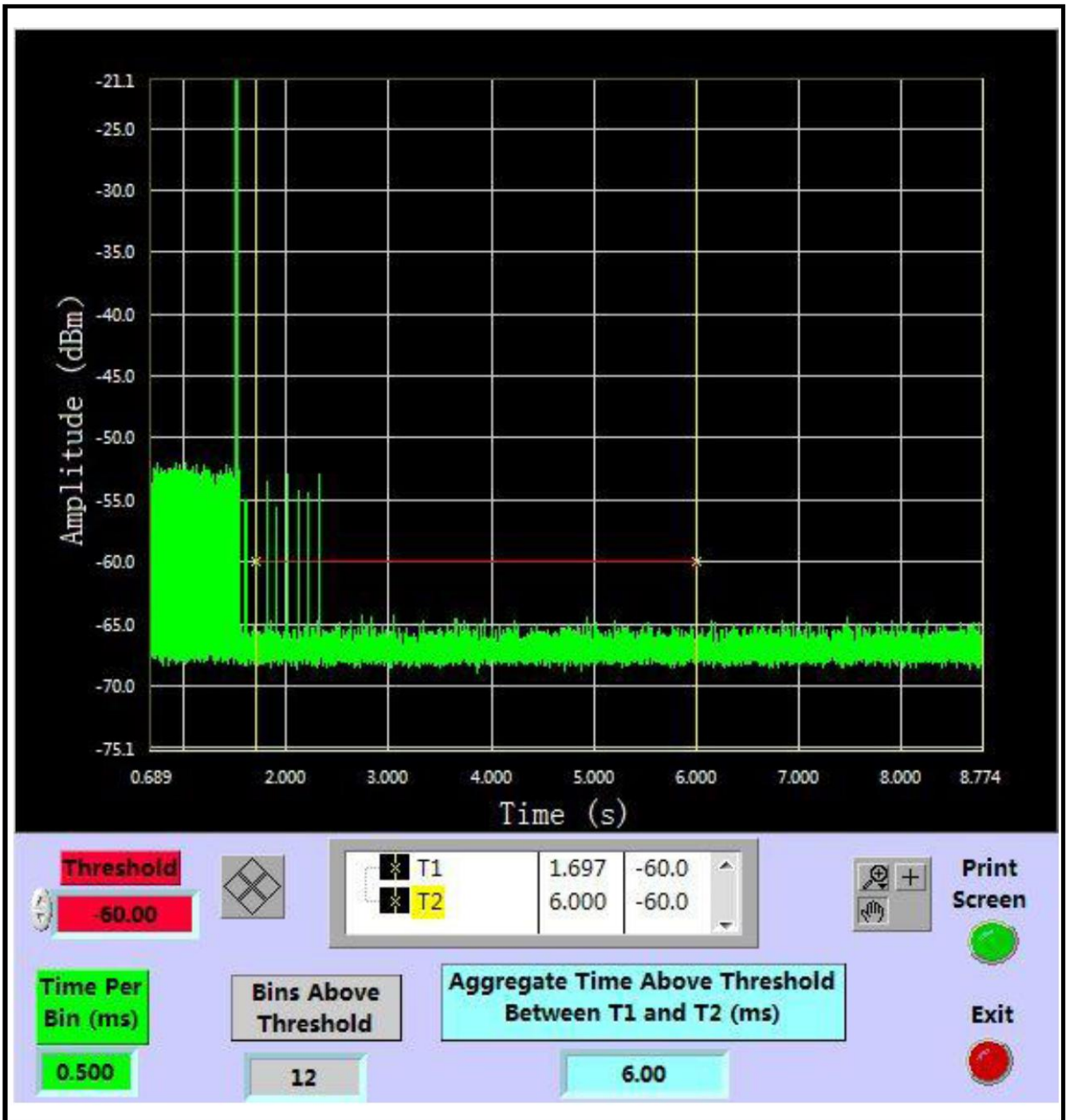









### DETECTION BANDWIDTH

#### IEEE 802.11n 20 MHz Mode

Test Results

No non-compliance noted.

FL(MHz)	FH(MHz)	Detection Bandwidth(MHz)	99% Power Bandwidth(MHz)	Ratio of Detection BW to 99% Power BW(MHz)	Minimum Limit (%)
5291	5309	18	17.585	102.36	100

Number of Trials	Frequency (MHz)	Number Detected	Detection(%)
10	5291	10	100
10	5292	9	90
10	5293	10	100
10	5294	9	90
10	5295	8	80
10	5300	10	100
10	5305	8	80
10	5306	10	100
10	5307	9	90
10	5308	10	100
10	5309	10	100





IEEE 802.11n 40 MHz Mode

Test Results  
 No non-compliance noted.

FL(MHz)	FH(MHz)	Detection Bandwidth(MHz)	99% Power Bandwidth(MHz)	Ratio of Detection BW to 99% Power BW(MHz)	Minimum Limit (%)
5291	5328	36	35.973	100.07	100

Number of Trials	Frequency (MHz)	Number Detected	Detection(%)
10	5292	9	90
10	5293	10	100
10	5294	9	90
10	5295	10	100
10	5300	10	100
10	5305	9	90
10	5310	10	100
10	5315	8	80
10	5320	10	100
10	5325	10	100
10	5326	9	90
10	5327	8	80
10	5328	10	100



IEEE 802.11ac 80 MHz Mode

Test Results  
 No non-compliance noted.

FL(MHz)	FH(MHz)	Detection Bandwidth(MHz)	99% Power Bandwidth(MHz)	Ratio of Detection BW to 99% Power BW(MHz)	Minimum Limit (%)
5252	5328	76	74.884	101.49	100

Number of Trials	Frequency (MHz)	Number Detected	Detection(%)
10	5252	10	100
10	5253	10	100
10	5254	9	90
10	5255	10	100
10	5260	8	80
10	5265	9	90
10	5270	10	100
10	5275	9	90
10	5280	10	100
10	5285	9	90
10	5290	10	100
10	5295	10	100
10	5300	8	80
10	5305	9	90
10	5310	10	100
10	5315	9	90
10	5320	10	100
10	5325	10	100
10	5326	8	80
10	5327	10	100
10	5328	9	90



### Statistical Performance Check

IEEE 802.11n 20 MHz Mode

Test Results

No non-compliance noted:

Summary of Detection Probability

Radar Type	Number of Trials	Detection (%)	Limit (%)	Pass / Fail
Type 1	30	93.33	60	Pass
Type 2	30	96.67	60	Pass
Type 3	30	96.67	60	Pass
Type 4	30	96.67	60	Pass
Aggregate of 1 to 4	30	95.84	80	Pass
Type 5	30	96.67	70	Pass
Type 6	30	96.67	80	Pass

Type 1 Detection Probability



Trial No.	Successful Detection (Yes/No)
1	YES
2	YES
3	YES
4	YES
5	YES
6	YES
7	YES
8	YES
9	YES
10	YES
11	NO
12	YES
13	YES
14	YES
15	YES
16	YES
17	YES
18	YES
19	YES
20	YES
21	YES
22	YES
23	NO
24	YES
25	YES
26	YES
27	YES
30	YES

Type 2 Detection Probability



Trial No.	Successful Detection (Yes/No)
1	YES
2	YES
3	YES
4	YES
5	YES
6	YES
7	YES
8	YES
9	YES
10	NO
11	YES
12	YES
13	YES
14	YES
15	YES
16	YES
17	YES
18	YES
19	YES
20	YES
21	NO
22	YES
23	YES
24	YES
25	YES
26	YES
27	YES
30	YES



Type 3 Detection Probability

Trial No.	Successful Detection (Yes/No)
1	YES
2	YES
3	YES
4	YES
5	YES
6	YES
7	YES
8	YES
9	YES
10	YES
11	YES
12	YES
13	YES
14	YES
15	YES
16	YES
17	YES
18	YES
19	YES
20	YES
21	YES
22	YES
23	YES
24	YES
25	NO
26	YES
27	YES
30	YES



Type 4 Detection Probability:

Trial No.	Successful Detection (Yes/No)
1	YES
2	YES
3	YES
4	YES
5	YES
6	NO
7	YES
8	YES
9	YES
10	YES
11	YES
12	YES
13	YES
14	YES
15	YES
16	YES
17	NO
18	YES
19	YES
20	YES
21	YES
22	YES
23	YES
24	YES
25	YES
26	YES
27	YES
30	YES



Type 5 Detection Probability

Trial No.	Successful Detection (Yes/No)
1	YES
2	YES
3	YES
4	YES
5	YES
6	YES
7	YES
8	YES
9	NO
10	YES
11	YES
12	YES
13	YES
14	YES
15	YES
16	YES
17	YES
18	YES
19	YES
20	YES
21	YES
22	YES
23	YES
24	YES
25	YES
26	YES
27	YES
30	YES





Type 6 Detection Probability

Trial No.	Successful Detection (Yes/No)
1	YES
2	YES
3	YES
4	YES
5	YES
6	YES
7	NO
8	YES
9	YES
10	YES
11	YES
12	YES
13	YES
14	YES
15	YES
16	YES
17	YES
18	NO
19	YES
20	YES
21	YES
22	YES
23	YES
24	YES
25	YES
26	YES
27	YES
30	YES



IEEE 802.11n 40 MHz Mode

Test Results

No non-compliance noted:

Summary of Detection Probability

Radar Type	Number of Trials	Detection (%)	Limit (%)	Pass / Fail
Type 1	30	90.00	60	Pass
Type 2	30	96.67	60	Pass
Type 3	30	90.00	60	Pass
Type 4	30	96.67	60	Pass
Aggregate of 1 to 4	30	93.34	80	Pass
Type 5	30	96.67	70	Pass
Type 6	30	96.67	80	Pass

Type 1 Detection Probability



Trial No.	Successful Detection (Yes/No)
1	YES
2	YES
3	YES
4	YES
5	YES
6	YES
7	YES
8	YES
9	YES
10	YES
11	YES
12	YES
13	YES
14	YES
15	NO
16	YES
17	YES
18	YES
19	YES
20	YES
21	YES
22	YES
23	YES
24	YES
25	NO
26	YES
27	YES
30	YES



Type 2 Detection Probability

Trial No.	Successful Detection (Yes/No)
1	YES
2	YES
3	YES
4	YES
5	YES
6	YES
7	YES
8	YES
9	YES
10	YES
11	YES
12	NO
13	YES
14	YES
15	YES
16	YES
17	YES
18	YES
19	YES
20	YES
21	YES
22	NO
23	YES
24	YES
25	YES
26	YES
27	YES
30	YES



Type 3 Detection Probability

Trial No.	Successful Detection (Yes/No)
1	YES
2	YES
3	YES
4	YES
5	YES
6	YES
7	YES
8	YES
9	NO
10	YES
11	YES
12	YES
13	YES
14	YES
15	YES
16	YES
17	YES
18	YES
19	NO
20	YES
21	YES
22	YES
23	YES
24	YES
25	YES
26	YES
27	YES
30	YES



Type 4 Detection Probability

Trial No.	Successful Detection (Yes/No)
1	YES
2	YES
3	YES
4	YES
5	YES
6	YES
7	YES
8	YES
9	YES
10	NO
11	YES
12	YES
13	YES
14	YES
15	YES
16	YES
17	YES
18	YES
19	YES
20	YES
21	YES
22	YES
23	YES
24	YES
25	YES
26	YES
27	YES
30	YES



Type 5 Detection Probability

Trial No.	Successful Detection (Yes/No)
1	YES
2	YES
3	YES
4	YES
5	YES
6	NO
7	YES
8	YES
9	YES
10	YES
11	YES
12	YES
13	YES
14	YES
15	YES
16	YES
17	YES
18	YES
19	YES
20	NO
21	YES
22	YES
23	YES
24	YES
25	YES
26	YES
27	YES
30	YES



Type 6 Detection Probability





Trial No.	Successful Detection (Yes/No)
1	YES
2	YES
3	YES
4	YES
5	YES
6	YES
7	YES
8	YES
9	YES
10	YES
11	YES
12	NO
13	YES
14	YES
15	YES
16	YES
17	YES
18	YES
19	YES
20	YES
21	YES
22	NO
23	YES
24	YES
25	YES
26	YES
27	YES
30	YES



IEEE 802.11ac 80 MHz Mode

Test Results

No non-compliance noted:

Summary of Detection Probability

<b>Radar Type</b>	<b>Number of Trials</b>	<b>Detection (%)</b>	<b>Limit (%)</b>	<b>Pass / Fail</b>
Type 1	30	96.67	60	Pass
Type 2	30	96.67	60	Pass
Type 3	30	96.67	60	Pass
Type 4	30	96.67	60	Pass
Aggregate of 1 to 4	30	96.67	80	Pass
Type 5	30	96.67	70	Pass
Type 6	30	96.67	80	Pass

Type 1 Detection Probability



Trial No.	Successful Detection (Yes/No)
1	YES
2	YES
3	YES
4	YES
5	YES
6	YES
7	YES
8	YES
9	YES
10	NO
11	YES
12	YES
13	YES
14	YES
15	YES
16	YES
17	NO
18	YES
19	YES
20	YES
21	YES
22	YES
23	YES
24	YES
25	YES
26	YES
27	YES
30	YES



Type 2 Detection Probability

Trial No.	Successful Detection (Yes/No)
1	YES
2	YES
3	YES
4	YES
5	YES
6	YES
7	YES
8	YES
9	YES
10	YES
11	YES
12	YES
13	NO
14	YES
15	YES
16	YES
17	YES
18	YES
19	YES
20	YES
21	YES
22	YES
23	YES
24	YES
25	YES
26	YES
27	YES
30	YES



Type 3 Detection Probability

Trial No.	Successful Detection (Yes/No)
1	YES
2	YES
3	YES
4	YES
5	NO
6	YES
7	YES
8	YES
9	YES
10	YES
11	YES
12	YES
13	NO
14	YES
15	YES
16	YES
17	YES
18	YES
19	YES
20	YES
21	YES
22	YES
23	YES
24	YES
25	YES
26	NO
27	YES
30	YES



Type 4 Detection Probability

Trial No.	Successful Detection (Yes/No)
1	YES
2	YES
3	YES
4	YES
5	YES
6	YES
7	YES
8	YES
9	YES
10	YES
11	YES
12	YES
13	YES
14	NO
15	YES
16	YES
17	YES
18	YES
19	YES
20	YES
21	YES
22	NO
23	YES
24	YES
25	YES
26	YES
27	YES
30	YES



Type 5 Detection Probability

Trial No.	Successful Detection (Yes/No)
1	YES
2	YES
3	YES
4	YES
5	YES
6	YES
7	YES
8	YES
9	YES
10	YES
11	YES
12	YES
13	YES
14	YES
15	YES
16	YES
17	NO
18	YES
19	YES
20	YES
21	YES
22	YES
23	YES
24	YES
25	YES
26	YES
27	YES
30	YES



Type 6 Detection Probability

Trial No.	Successful Detection (Yes/No)
1	YES
2	YES
3	YES
4	YES
5	YES
6	YES
7	YES
8	YES
9	YES
10	YES
11	YES
12	YES
13	YES
14	YES
15	YES
16	NO
17	YES
18	YES
19	YES
20	YES
21	YES
22	NO
23	YES
24	YES
25	YES
26	YES
27	YES
30	YES







### Channel Closing Transmission Time Results

No non-compliance noted.

Transmission After200(ms)	AggregateTransmission Time(ms)	Limit for Aggregate Transmission TimeAfter 200 (ms)	Result
Yes	6.50	60	PASS

Only intermittent transmissions are observed during the aggregate monitoring period.

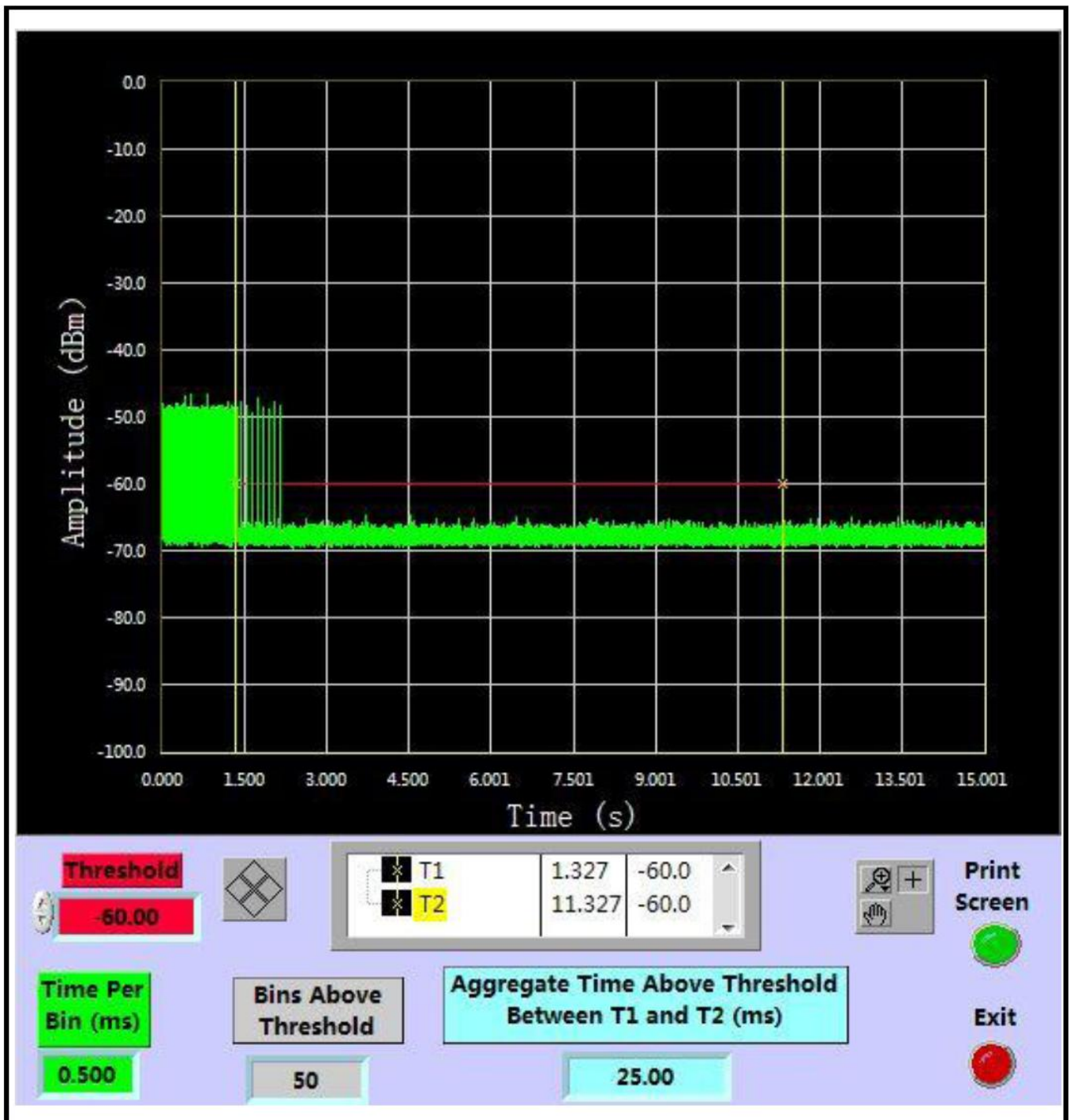

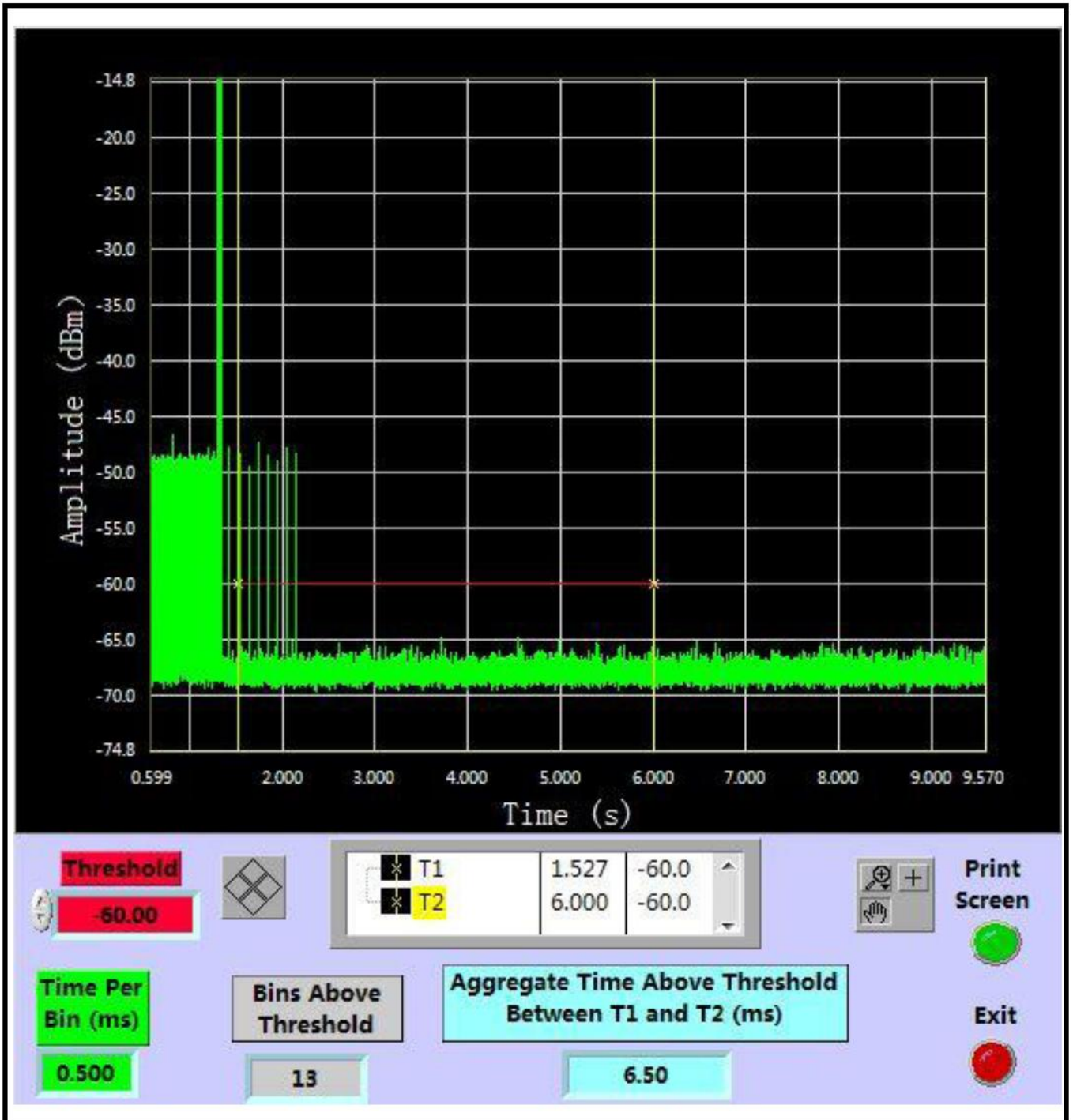









**DETECTION BANDWIDTH**

IEEE 802.11n 20 MHz Mode

Test Results

No non-compliance noted.

FL(MHz)	FH(MHz)	Detection Bandwidth(MHz)	99% Power Bandwidth(MHz)	Ratio of Detection BW to 99% Power BW(MHz)	Minimum Limit (%)
5491	5509	18	17.589	102.34	100

Number of Trials	Frequency (MHz)	Number Detected	Detection(%)
10	5491	9	90
10	5492	10	100
10	5493	10	100
10	5494	9	90
10	5495	10	100
10	5500	10	100
10	5505	10	100
10	5506	8	80
10	5507	10	100
10	5508	8	80
10	5509	10	100



IEEE 802.11n 40 MHz Mode

Test Results  
No non-compliance noted.

FL(MHz)	FH(MHz)	Detection Bandwidth(MHz)	99% Power Bandwidth(MHz)	Ratio of Detection BW to 99% Power BW(MHz)	Minimum Limit (%)
5492	5528	36	35.964	100.10	100

Number of Trials	Frequency (MHz)	Number Detected	Detection(%)
10	5292	9	90
10	5293	10	100
10	5294	10	100
10	5295	8	80
10	5300	10	100
10	5305	8	80
10	5510	10	100
10	5515	9	90
10	5520	10	100
10	5525	10	100
10	5526	10	100
10	5527	9	90
10	5528	9	90





IEEE 802.11ac 80 MHz Mode

Test Results  
 No non-compliance noted.

FL(MHz)	FH(MHz)	Detection Bandwidth(MHz)	99% Power Bandwidth(MHz)	Ratio of Detection BW to 99% Power BW(MHz)	Minimum Limit (%)
5292	5568	76	74.862	101.52	100

Number of Trials	Frequency (MHz)	Number Detected	Detection(%)
10	5492	9	90
10	5493	10	100
10	5494	10	100
10	5495	10	100
10	5500	10	100
10	5505	9	90
10	5510	10	100
10	5515	10	100
10	5520	10	100
10	5525	8	80
10	5530	10	100
10	5535	9	90
10	5540	10	100
10	5545	9	90
10	5550	10	100
10	5555	10	100
10	5560	9	90
10	5565	10	100
10	5566	9	90
10	5567	10	100
10	5568	9	90





### Statistical Performance Check

IEEE 802.11n 20 MHz Mode

Test Results

No non-compliance noted:

Summary of Detection Probability

Radar Type	Number of Trials	Detection (%)	Limit (%)	Pass / Fail
Type 1	30	96.67	60	Pass
Type 2	30	93.33	60	Pass
Type 3	30	96.67	60	Pass
Type 4	30	96.67	60	Pass
Aggregate of 1 to 4	30	95.84	80	Pass
Type 5	30	96.67	70	Pass
Type 6	30	96.67	80	Pass

Type 1 Detection Probability



Trial No.	Successful Detection (Yes/No)
1	YES
2	YES
3	YES
4	YES
5	YES
6	YES
7	YES
8	YES
9	YES
10	YES
11	YES
12	NO
13	YES
14	YES
15	YES
16	YES
17	YES
18	YES
19	YES
20	YES
21	YES
22	YES
23	YES
24	YES
25	NO
26	YES
27	YES
30	YES



Type 2 Detection Probability

Trial No.	Successful Detection (Yes/No)
1	YES
2	YES
3	YES
4	YES
5	YES
6	YES
7	YES
8	YES
9	YES
10	YES
11	YES
12	NO
13	YES
14	YES
15	YES
16	YES
17	YES
18	YES
19	NO
20	YES
21	YES
22	YES
23	YES
24	YES
25	YES
26	YES
27	YES
30	YES



Type 3 Detection Probability

Trial No.	Successful Detection (Yes/No)
1	YES
2	YES
3	YES
4	YES
5	YES
6	YES
7	YES
8	YES
9	YES
10	YES
11	NO
12	YES
13	YES
14	YES
15	YES
16	YES
17	YES
18	YES
19	YES
20	NO
21	YES
22	YES
23	YES
24	YES
25	YES
26	YES
27	YES
30	YES



Type 4 Detection Probability

Trial No.	Successful Detection (Yes/No)
1	YES
2	YES
3	YES
4	YES
5	YES
6	YES
7	YES
8	YES
9	YES
10	YES
11	YES
12	YES
13	YES
14	YES
15	YES
16	YES
17	NO
18	YES
19	YES
20	YES
21	YES
22	YES
23	YES
24	YES
25	YES
26	YES
27	YES
30	YES



Type 5 Detection Probability

Trial No.	Successful Detection (Yes/No)
1	YES
2	YES
3	YES
4	YES
5	YES
6	YES
7	YES
8	YES
9	YES
10	YES
11	YES
12	YES
13	YES
14	YES
15	YES
16	NO
17	YES
18	YES
19	YES
20	YES
21	YES
22	YES
23	YES
24	YES
25	YES
26	YES
27	YES
30	YES





Type 6 Detection Probability

Trial No.	Successful Detection (Yes/No)
1	YES
2	YES
3	YES
4	YES
5	YES
6	YES
7	YES
8	YES
9	YES
10	YES
11	YES
12	YES
13	YES
14	YES
15	YES
16	YES
17	NO
18	YES
19	YES
20	YES
21	YES
22	YES
23	NO
24	YES
25	YES
26	YES
27	YES
30	YES



IEEE 802.11n 40 MHz Mode  
Test Results

No non-compliance noted:

Summary of Detection Probability

<b>Radar Type</b>	<b>Number of Trials</b>	<b>Detection (%)</b>	<b>Limit (%)</b>	<b>Pass / Fail</b>
Type 1	30	96.67	60	Pass
Type 2	30	96.67	60	Pass
Type 3	30	93.33	60	Pass
Type 4	30	96.67	60	Pass
Aggregate of 1 to 4	30	95.84	80	Pass
Type 5	30	96.67	70	Pass
Type 6	30	96.67	80	Pass

Type 1 Detection Probability



Trial No.	Successful Detection (Yes/No)
1	YES
2	YES
3	YES
4	YES
5	YES
6	YES
7	NO
8	YES
9	YES
10	YES
11	YES
12	YES
13	YES
14	NO
15	YES
16	YES
17	YES
18	YES
19	YES
20	YES
21	YES
22	YES
23	YES
24	YES
25	YES
26	YES
27	YES
30	YES

Type 2 Detection Probability



Trial No.	Successful Detection (Yes/No)
1	YES
2	YES
3	YES
4	YES
5	YES
6	YES
7	YES
8	YES
9	YES
10	YES
11	YES
12	YES
13	YES
14	YES
15	YES
16	YES
17	YES
18	YES
19	NO
20	YES
21	YES
22	YES
23	YES
24	YES
25	YES
26	YES
27	YES
30	YES



Type 3 Detection Probability

Trial No.	Successful Detection (Yes/No)
1	YES
2	YES
3	YES
4	YES
5	YES
6	YES
7	YES
8	YES
9	YES
10	YES
11	YES
12	YES
13	YES
14	YES
15	YES
16	NO
17	YES
18	YES
19	YES
20	YES
21	YES
22	YES
23	YES
24	NO
25	YES
26	YES
27	YES
30	YES



Type 4 Detection Probability

Trial No.	Successful Detection (Yes/No)
1	YES
2	YES
3	YES
4	YES
5	YES
6	YES
7	YES
8	YES
9	NO
10	YES
11	YES
12	YES
13	YES
14	YES
15	YES
16	YES
17	YES
18	YES
19	YES
20	YES
21	YES
22	NO
23	YES
24	YES
25	YES
26	YES
27	YES
30	YES



Type 5 Detection Probability

Trial No.	Successful Detection (Yes/No)
1	YES
2	YES
3	YES
4	YES
5	YES
6	YES
7	YES
8	YES
9	YES
10	YES
11	YES
12	YES
13	YES
14	YES
15	YES
16	YES
17	NO
18	YES
19	YES
20	YES
21	YES
22	YES
23	YES
24	YES
25	YES
26	YES
27	YES
30	YES



Type 6 Detection Probability

Trial No.	Successful Detection (Yes/No)
1	YES
2	YES
3	YES
4	YES
5	YES
6	YES
7	YES
8	YES
9	YES
10	YES
11	NO
12	YES
13	YES
14	YES
15	YES
16	YES
17	YES
18	YES
19	NO
20	YES
21	YES
22	YES
23	YES
24	YES
25	YES
26	YES
27	YES
30	YES





IEEE 802.11ac 80 MHz Mode  
Test Results

No non-compliance noted:

Summary of Detection Probability

Radar Type	Number of Trials	Detection (%)	Limit (%)	Pass / Fail
Type 1	30	96.67	60	Pass
Type 2	30	96.67	60	Pass
Type 3	30	96.67	60	Pass
Type 4	30	93.33	60	Pass
Aggregate of 1 to 4	30	95.84	80	Pass
Type 5	30	96.67	70	Pass
Type 6	30	96.67	80	Pass

Type 1 Detection Probability



Trial No.	Successful Detection (Yes/No)
1	YES
2	YES
3	YES
4	YES
5	YES
6	YES
7	YES
8	YES
9	YES
10	YES
11	YES
12	YES
13	YES
14	YES
15	NO
16	YES
17	YES
18	YES
19	YES
20	YES
21	YES
22	YES
23	NO
24	YES
25	YES
26	YES
27	YES
30	YES

Type 2 Detection Probability



Trial No.	Successful Detection (Yes/No)
1	YES
2	YES
3	YES
4	YES
5	YES
6	YES
7	YES
8	YES
9	YES
10	YES
11	YES
12	NO
13	YES
14	YES
15	YES
16	YES
17	YES
18	YES
19	YES
20	YES
21	YES
22	YES
23	YES
24	NO
25	YES
26	YES
27	YES
30	YES



Type 3 Detection Probability

Trial No.	Successful Detection (Yes/No)
1	YES
2	YES
3	YES
4	YES
5	YES
6	YES
7	YES
8	YES
9	YES
10	YES
11	YES
12	YES
13	YES
14	YES
15	YES
16	YES
17	YES
18	YES
19	YES
20	YES
21	YES
22	NO
23	YES
24	YES
25	YES
26	NO
27	YES
30	YES



Type 4 Detection Probability

Trial No.	Successful Detection (Yes/No)
1	YES
2	YES
3	YES
4	YES
5	YES
6	YES
7	YES
8	YES
9	YES
10	NO
11	YES
12	YES
13	YES
14	YES
15	YES
16	YES
17	YES
18	YES
19	YES
20	YES
21	YES
22	YES
23	YES
24	YES
25	YES
26	YES
27	YES
30	YES



Type 5 Detection Probability

Trial No.	Successful Detection (Yes/No)
1	YES
2	YES
3	YES
4	YES
5	YES
6	YES
7	YES
8	YES
9	YES
10	YES
11	YES
12	YES
13	YES
14	YES
15	YES
16	YES
17	YES
18	YES
19	NO
20	YES
21	YES
22	YES
23	YES
24	YES
25	YES
26	YES
27	YES
30	YES



Type 6 Detection Probability

Trial No.	Successful Detection (Yes/No)
1	YES
2	YES
3	YES
4	YES
5	YES
6	NO
7	YES
8	YES
9	YES
10	YES
11	YES
12	YES
13	YES
14	YES
15	YES
16	YES
17	YES
18	YES
19	YES
20	NO
21	YES
22	YES
23	YES
24	YES
25	YES
26	YES
27	YES
30	YES



## 5.7. Adaptivity

### Requirements and limits

When interference signal detected by relevant channel access mechanism UUT used. The UUT should stops transmissions on the current operating channel, apart from Short Control Signaling Transmissions with a maximum duty cycle of 5 % within an observation period of 50 ms,

### Test Procedure

1. The measurement procedure follows the clause 5.3.9.2.1 of the ETSI EN 301 893 V2.1.1 (2017-05).
2. The inference signal used shall be a band limited noise signal with a 100 % duty cycle.
3. Testing shall be performed at one channel out of the declared channels for each sub-band and the highest nominal channel bandwidth.

### Test Configuration

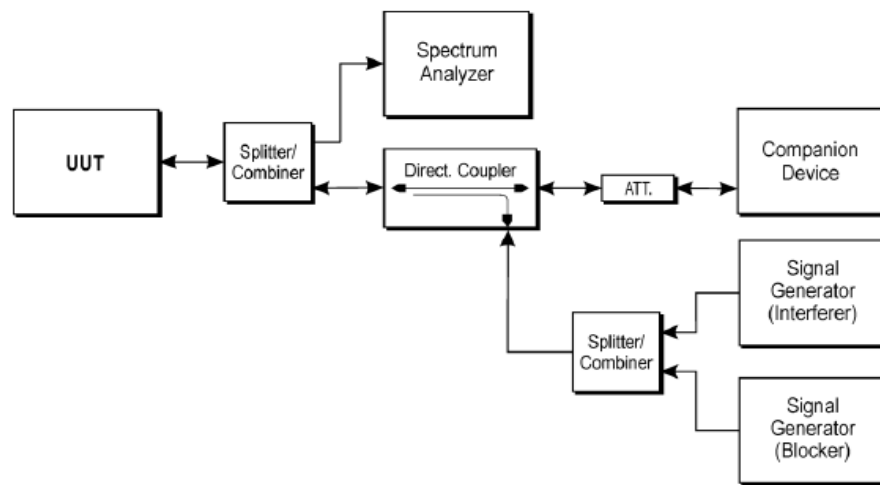

### Adaptivity Test schematic graphic







802.11a HT 20	5180	LTE	2000	-75	5	<=50	0.70	<2.5
802.11a HT 20	5180	OFDM	2000	-75	5	<=50	0.50	<2.5
802.11a HT 20	5180	AWGN	2000	-75	5	<=50	0.40	<2.5
802.11n HT 20	5180	LTE	2000	-75	5	<=50	0.30	<2.5
802.11n HT 20	5180	OFDM	2000	-75	5	<=50	0.32	<2.5
802.11n HT 20	5180	AWGN	2000	-75	5	<=50	2.30	<2.5
802.11n HT 40	5190	LTE	2000	-75	5	<=50	0.40	<2.5
802.11n HT 40	5190	OFDM	2000	-75	5	<=50	0.20	<2.5
802.11n HT 40	5190	AWGN	2000	-75	5	<=50	1.80	<2.5
802.11ac HT 20	5180	LTE	2000	-75	5	<=50	0.10	<2.5
802.11ac HT 20	5180	OFDM	2000	-75	5	<=50	0.20	<2.5
802.11ac HT 20	5180	AWGN	2000	-75	5	<=50	0.10	<2.5
802.11ac HT 40	5190	LTE	2000	-75	5	<=50	0.30	<2.5
802.11ac HT 40	5190	OFDM	2000	-75	5	<=50	0.10	<2.5
802.11ac HT 40	5190	AWGN	2000	-75	5	<=50	0.10	<2.5
802.11n HT 80	5210	LTE	2000	-75	5	<=50	0.20	<2.5
802.11n HT 80	5210	OFDM	2000	-75	5	<=50	0.20	<2.5
802.11n HT 80	5210	AWGN	2000	-75	5	<=50	0.10	<2.5

Adaptivity\_Max.COT\_11a HT20\_5180

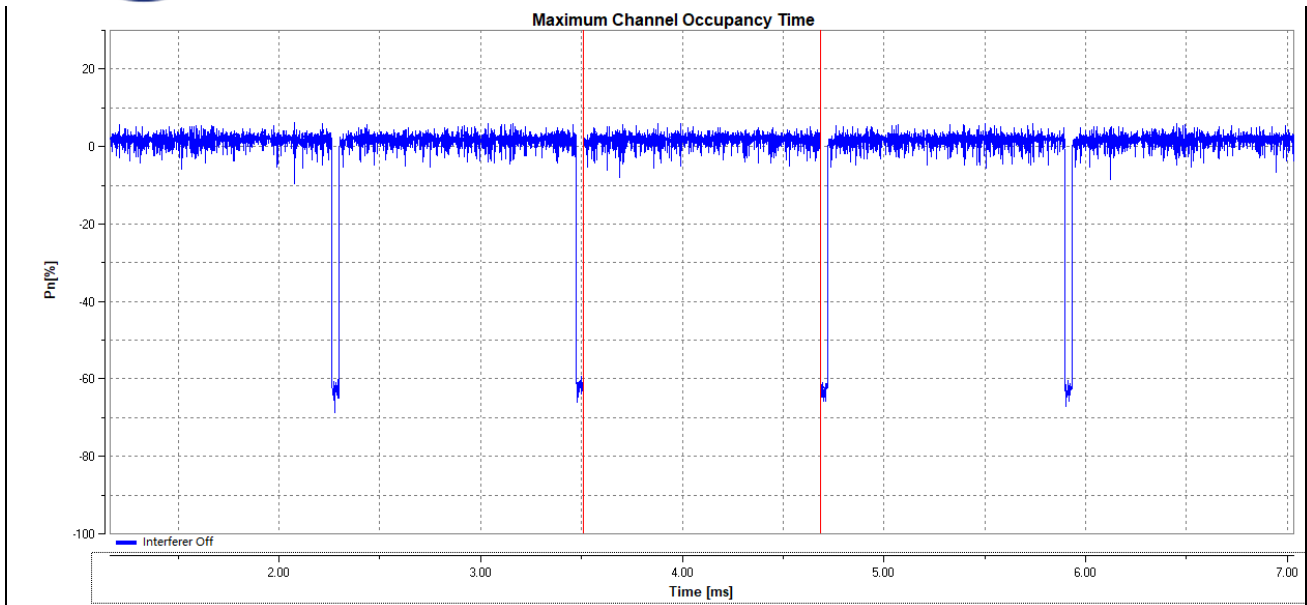

### Adaptivity\_Min.IdleTime\_11a HT20\_5180

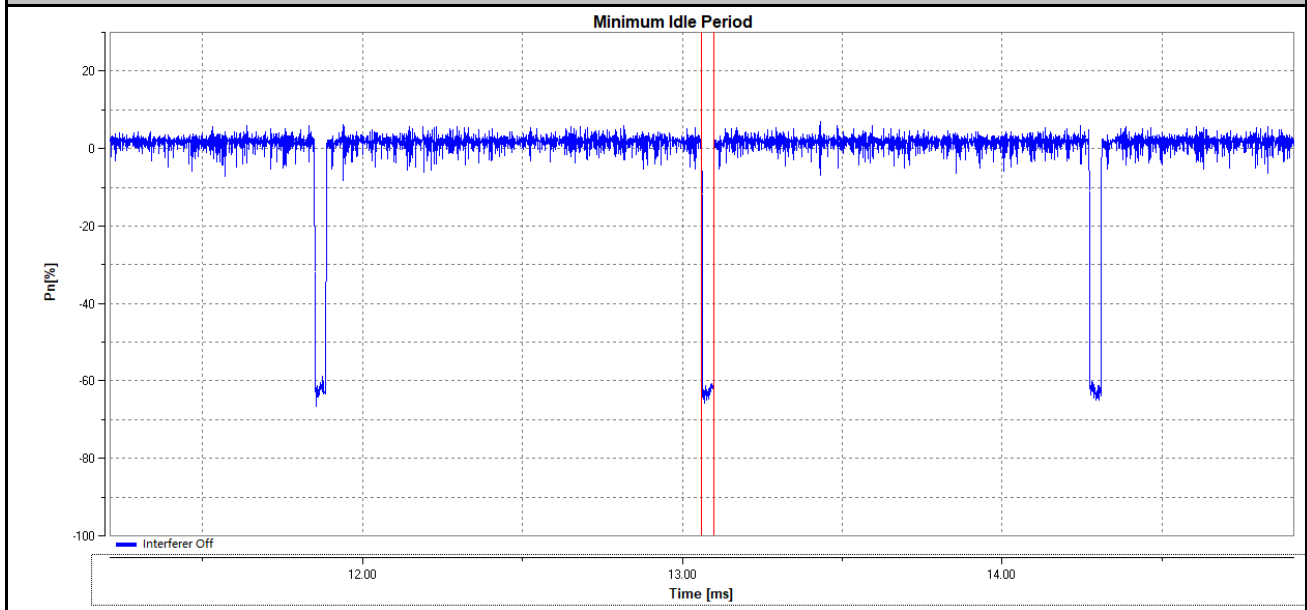

### Adaptivity\_Idle Period probability11a HT20\_\_5180

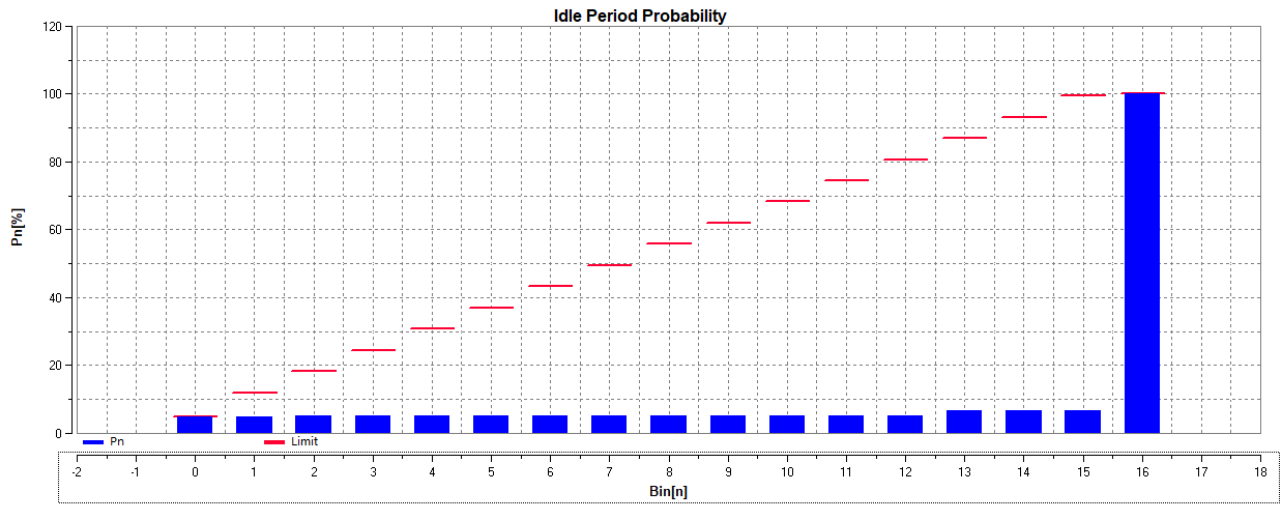

n	0	1	2	3	4	5	6	7	8	9	10	11	12	13	14	15	16
B[n]	45	0	2	0	2	0	0	0	0	0	0	0	0	12	0	0	868
P[n]	4.84	4.84	5.06	5.06	5.27	5.27	5.27	5.27	5.27	5.27	5.27	5.27	5.27	6.57	6.57	6.57	100
Limit	5	12	18.25	24.5	30.75	37	43.25	49.5	55.75	62	68.25	74.5	80.75	87	93.25	99.5	100

### Adaptivity\_Max.COT\_11n HT20\_5180

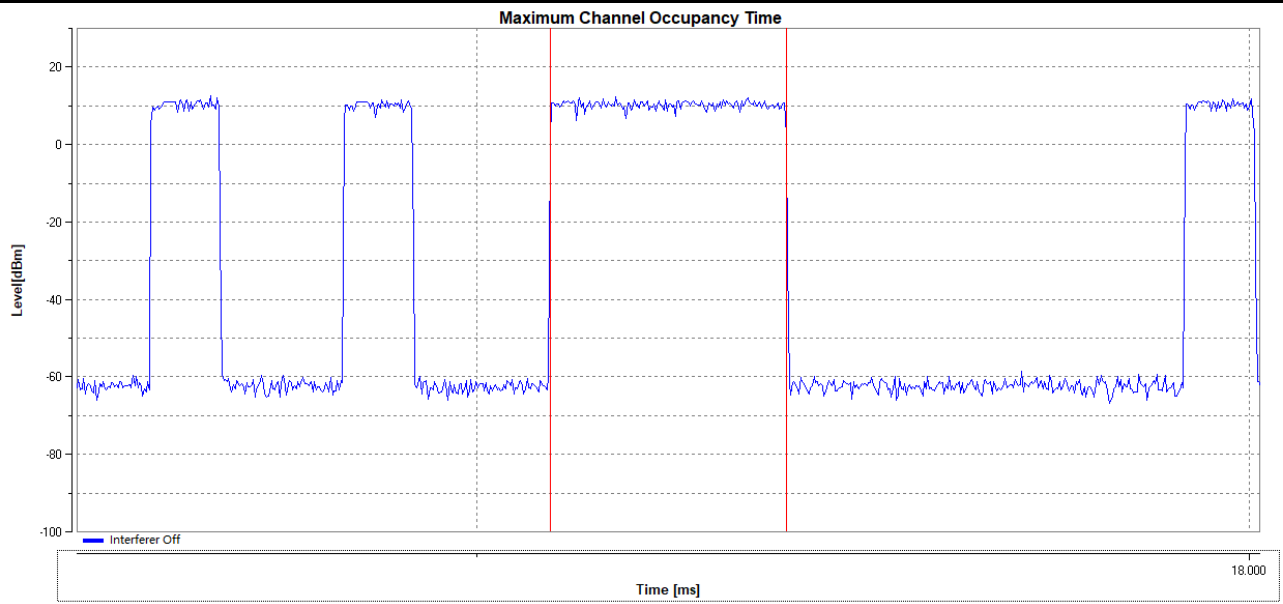



Adaptivity\_Min.IdleTime\_11n HT20\_5180

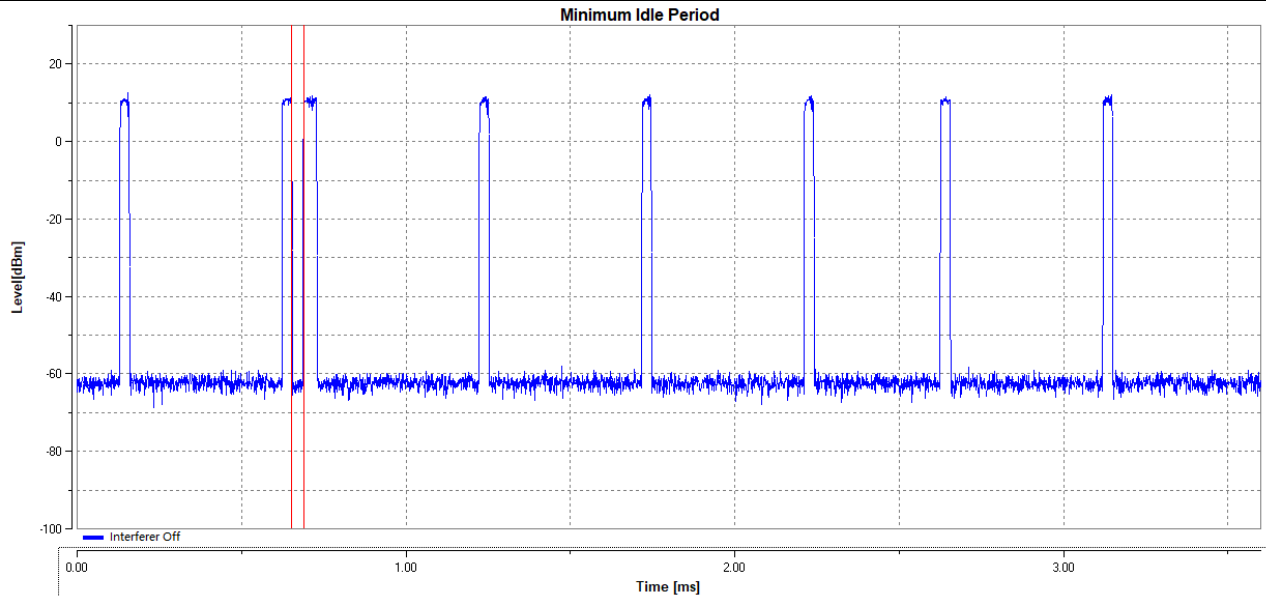

Adaptivity\_Idle Period probability\_11n HT20\_5180

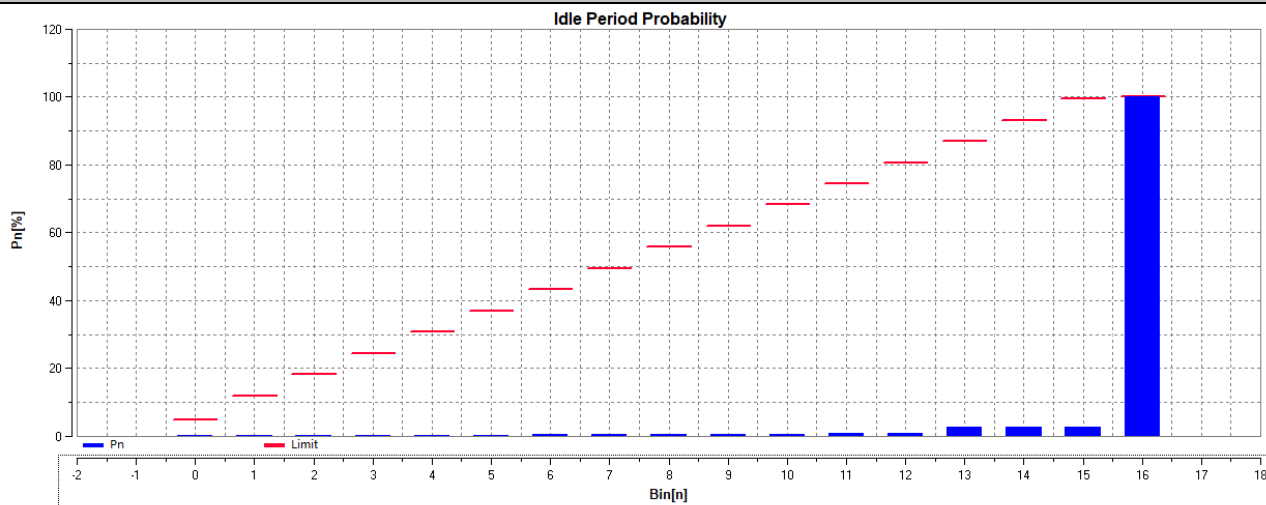

n	0	1	2	3	4	5	6	7	8	9	10	11	12	13	14	15	16
B[n]	2	0	0	1	0	1	1	2	0	0	0	1	0	18	0	0	921
P[n]	0.21	0.21	0.21	0.32	0.32	0.42	0.53	0.74	0.74	0.74	0.74	0.84	0.84	2.75	2.75	2.75	100
Limit	5	12	18.25	24.5	30.75	37	43.25	49.5	55.75	62	68.25	74.5	80.75	87	93.25	99.5	100



TEST PLOT

Adaptivity\_LTE\_TNVN\_11a HT20\_5180

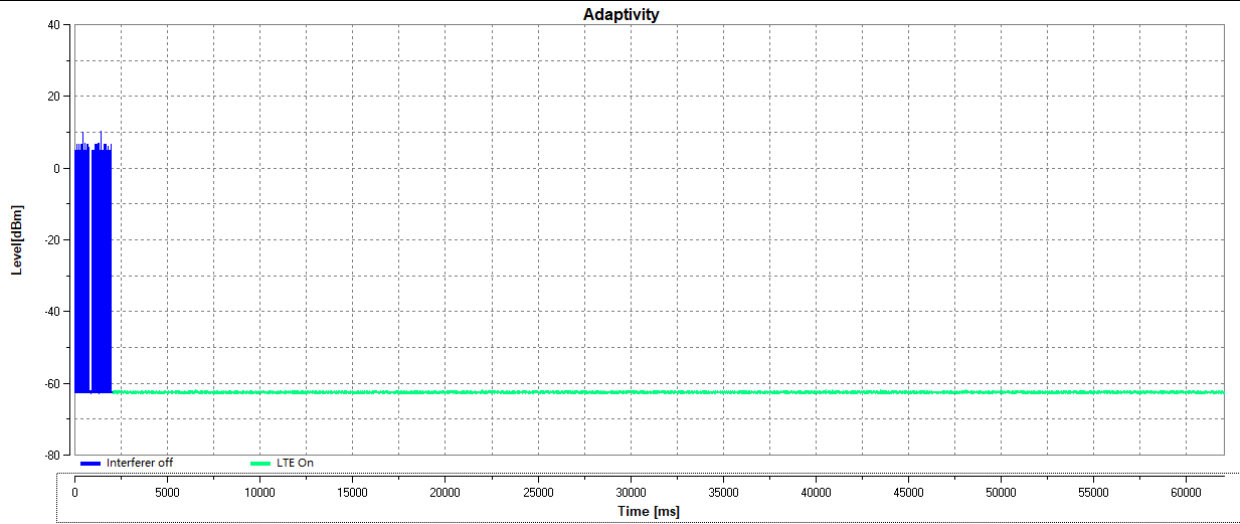

Adaptivity\_OFDM\_TNVN\_11a HT20\_5180

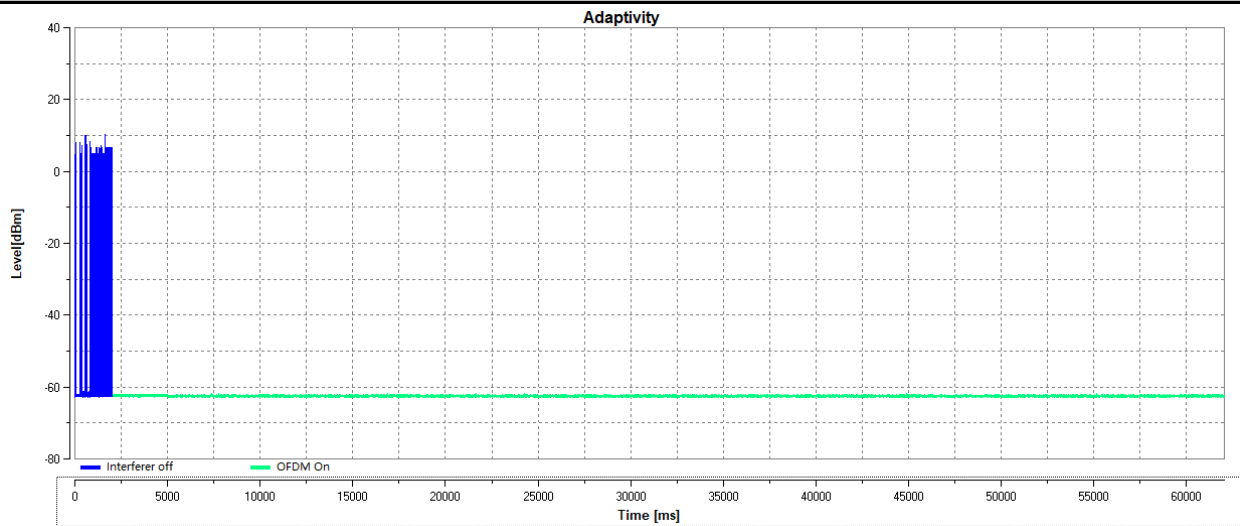



Adaptivity\_AWGN\_11a HT20\_5180

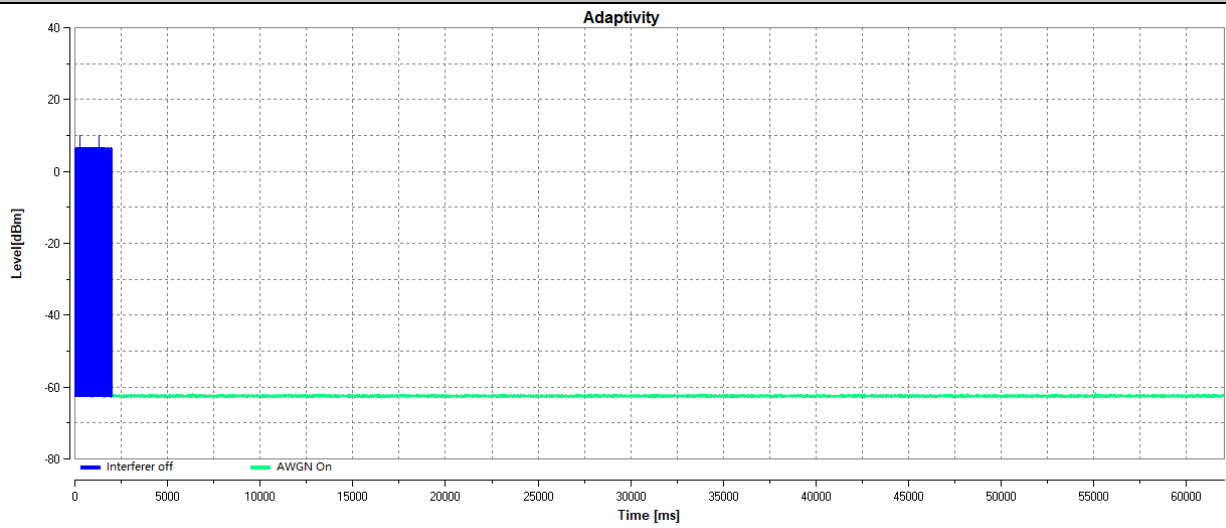

Adaptivity\_LTE\_11n HT20\_5180

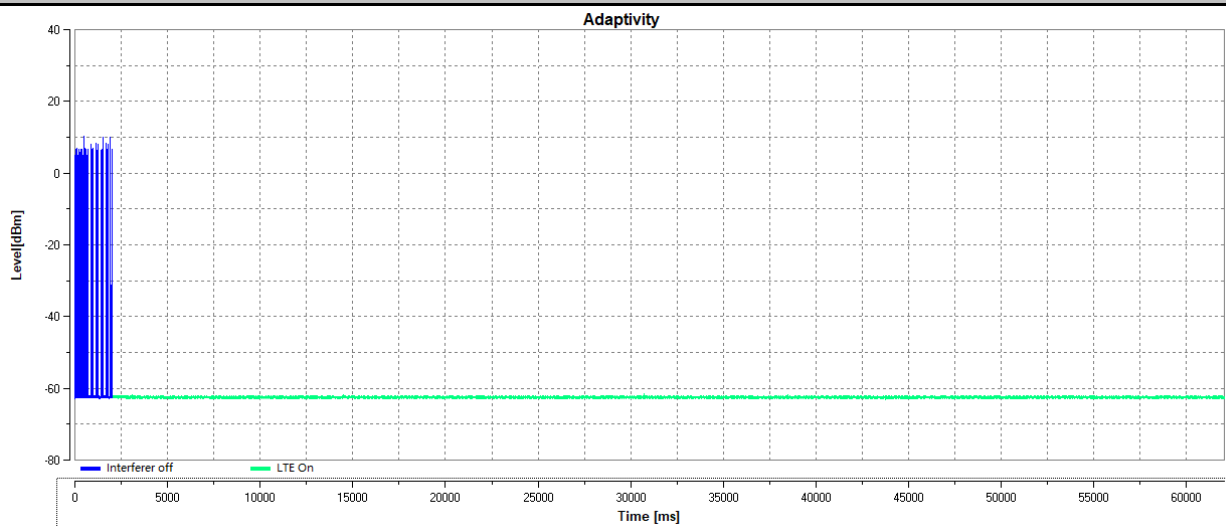



### Adaptivity\_OFDM\_11n HT20\_5180

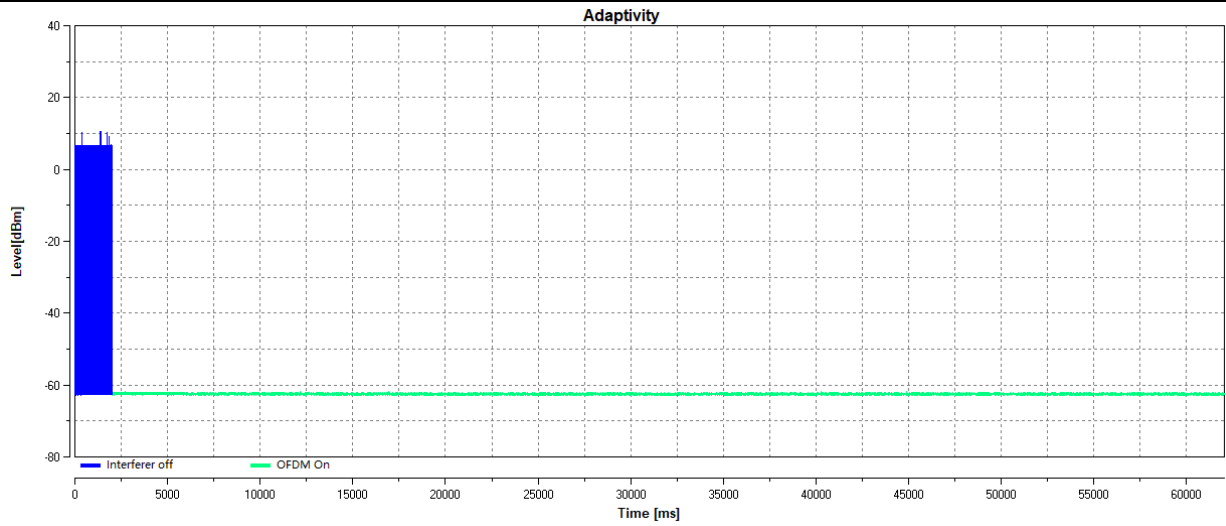

### Adaptivity\_AWGN\_11n HT20\_5180

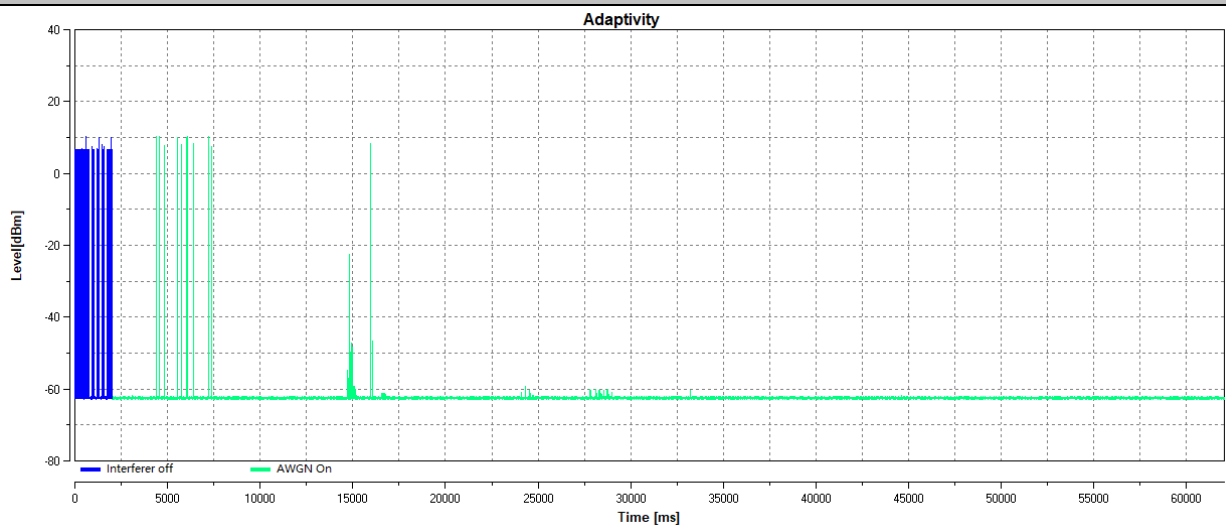



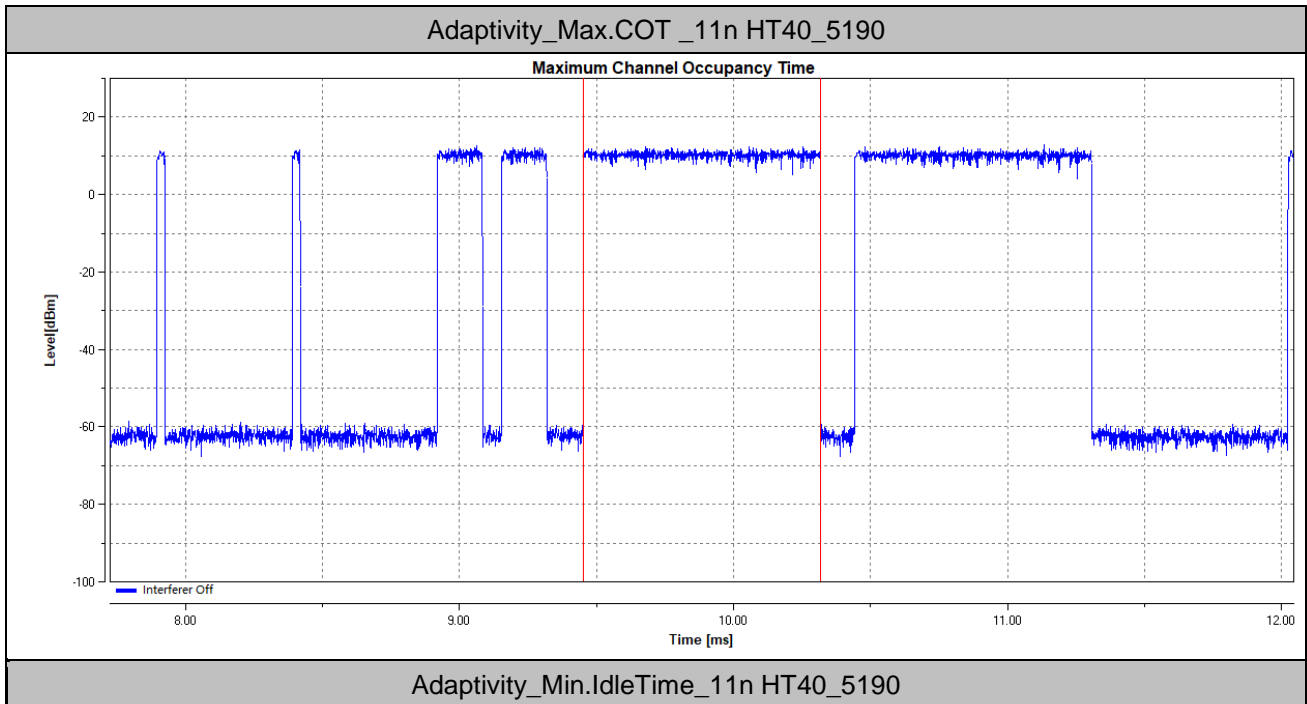

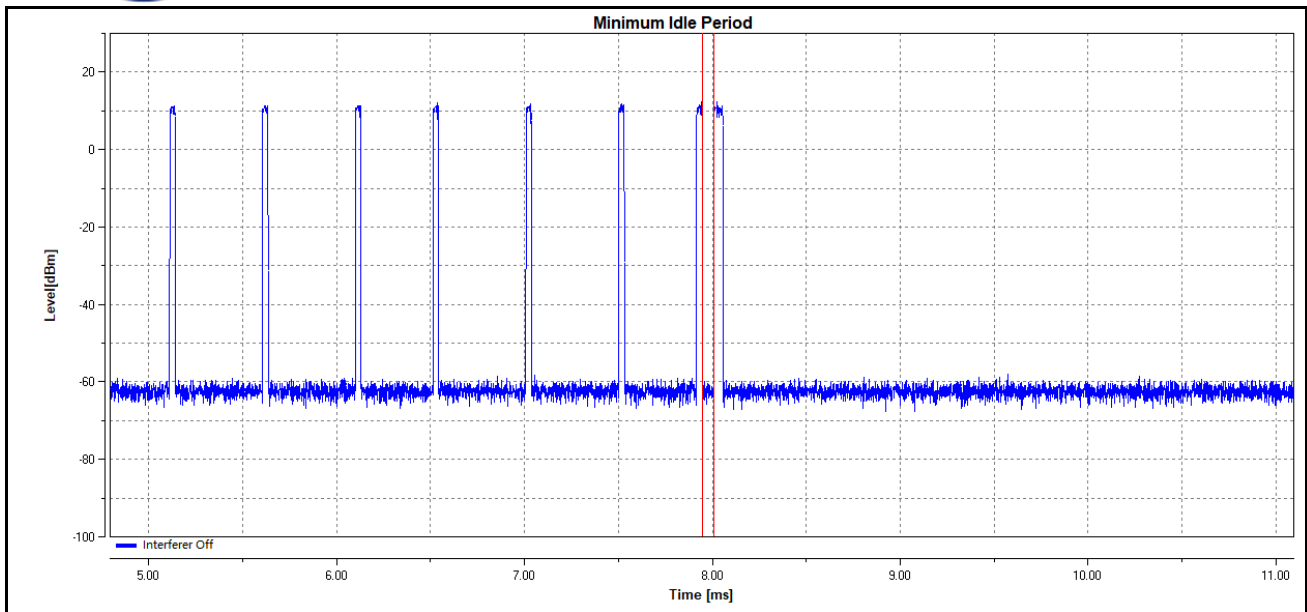

Adaptivity\_Idle Period probability\_11n HT40\_5190

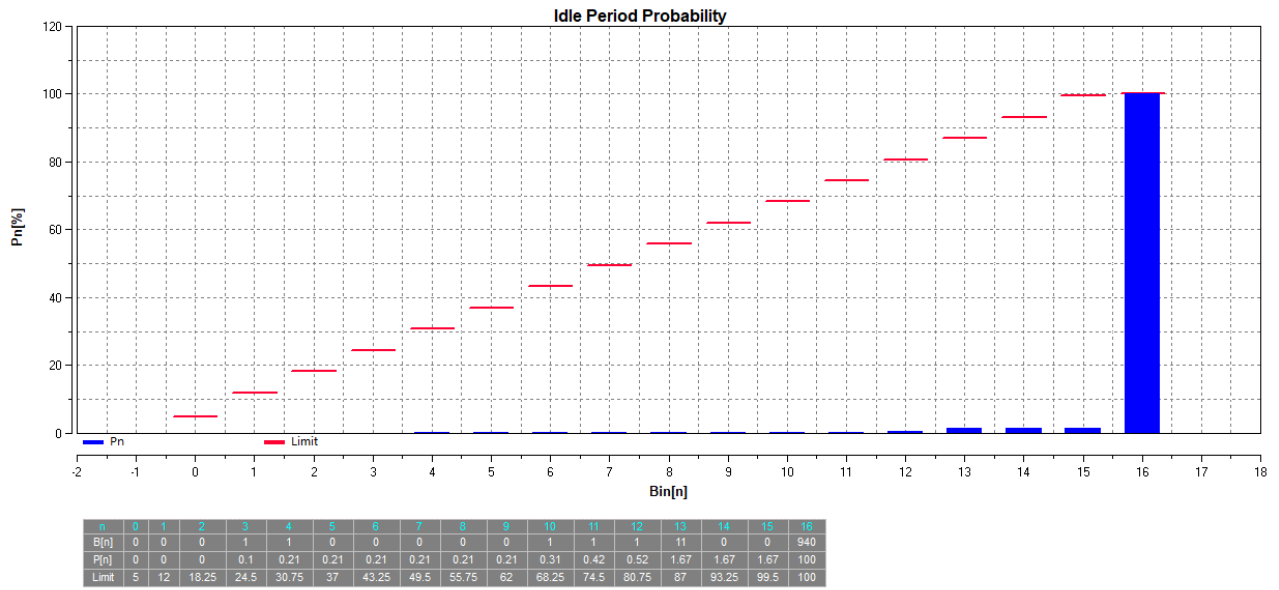

### Adaptivity\_Max.COT\_11ac HT20\_5180

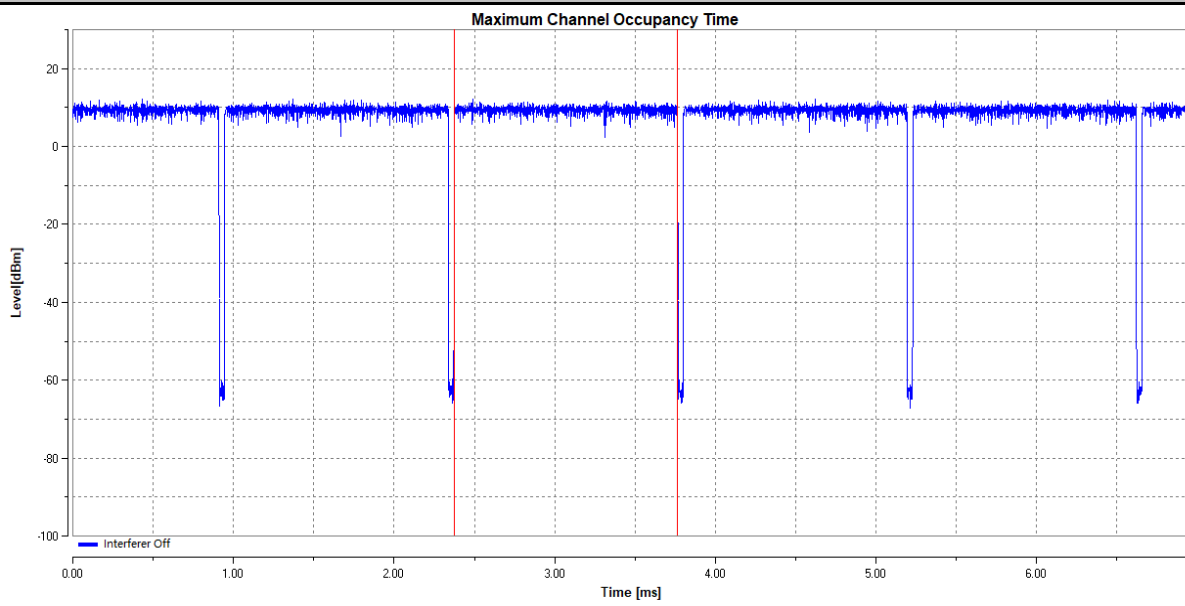



Adaptivity\_Min.IdleTime\_11ac HT20\_5180

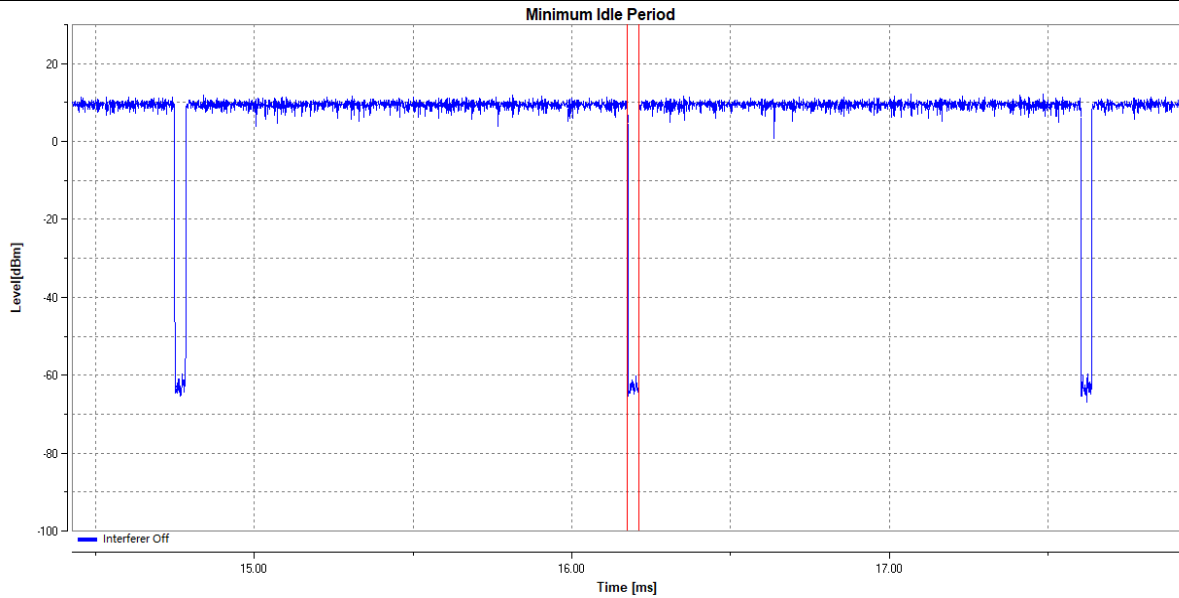

Adaptivity\_Idle Period probability\_11ac HT20\_5180

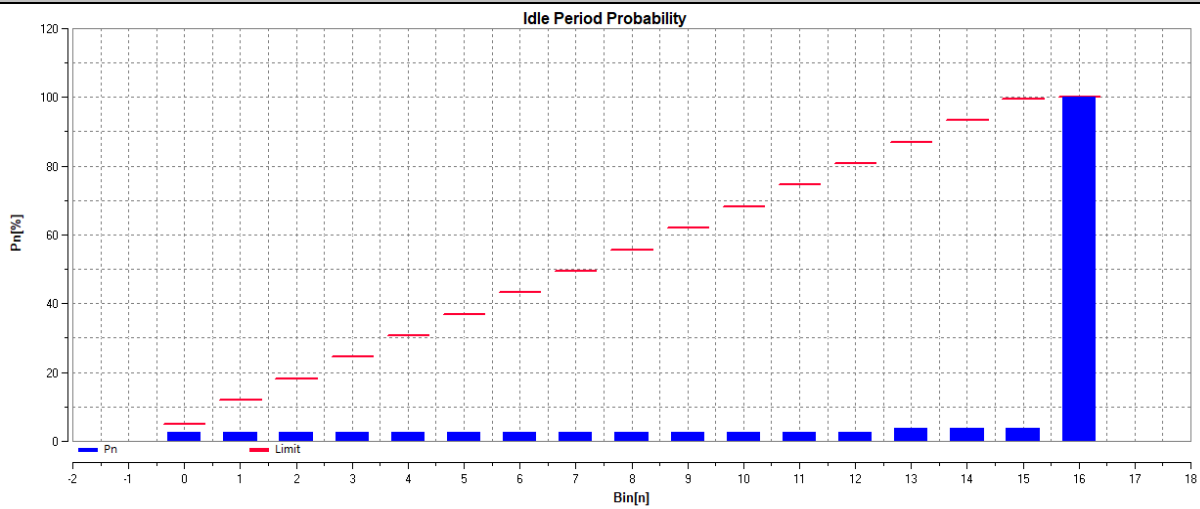

n	0	1	2	3	4	5	6	7	8	9	10	11	12	13	14	15	16
B[n]	26	1	0	0	0	0	0	0	0	0	0	0	0	10	0	0	964
P[n]	2.6	2.7	2.7	2.7	2.7	2.7	2.7	2.7	2.7	2.7	2.7	2.7	2.7	3.7	3.7	3.7	100
Limit	5	12	18.25	24.5	30.75	37	43.25	49.5	55.75	62	68.25	74.5	80.75	87	93.25	99.5	100



TEST PLOT

Adaptivity\_LTE\_TNVN\_11n HT40\_5190

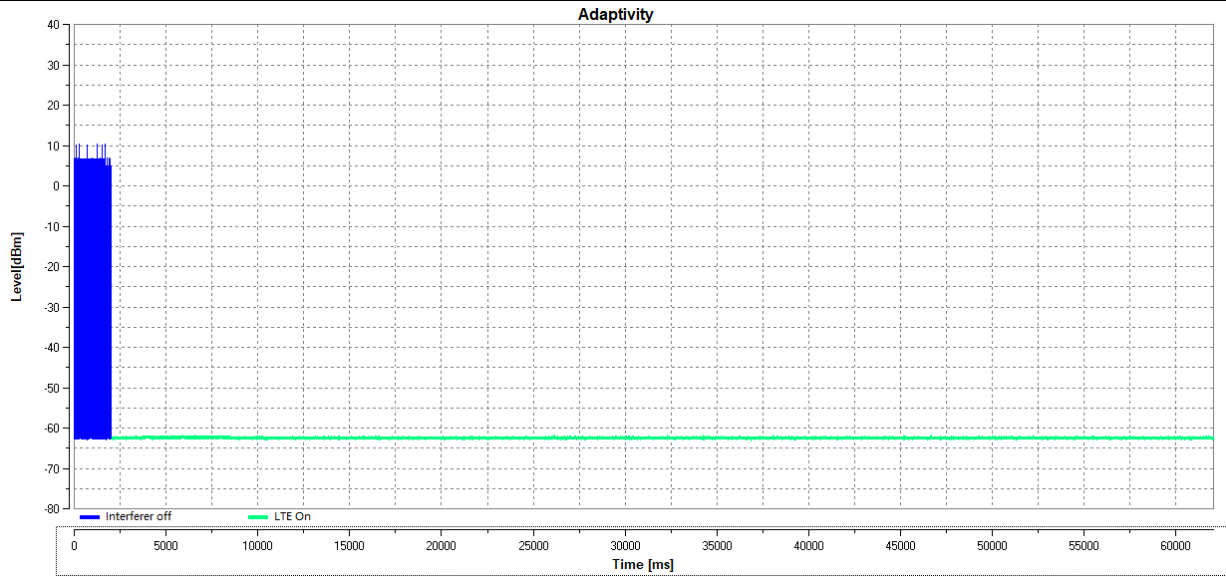

Adaptivity\_OFDM\_TNVN\_11n HT40\_5190

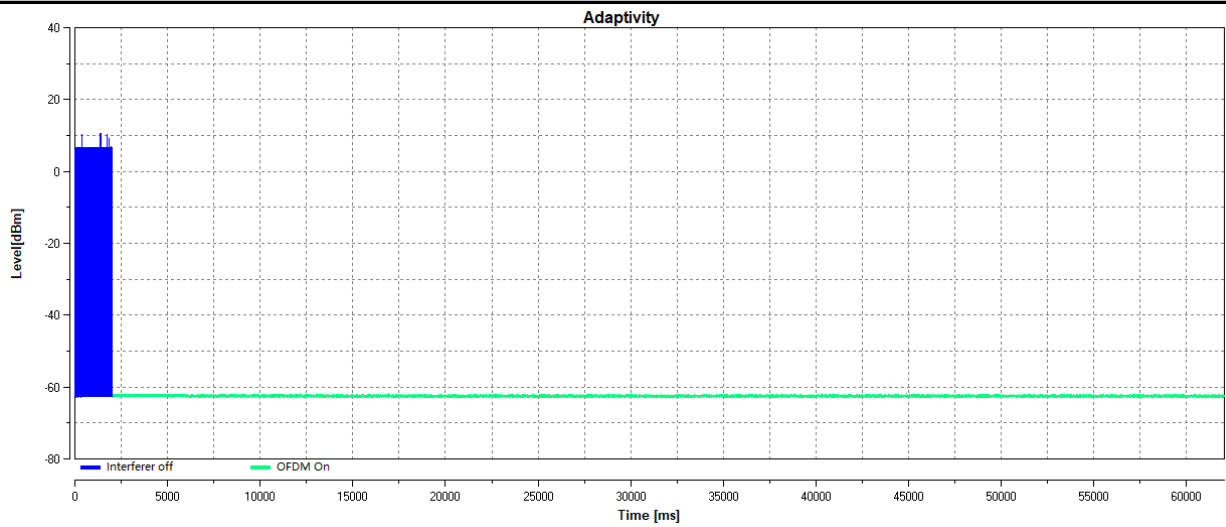



### Adaptivity\_AWGN\_11n HT40\_5190

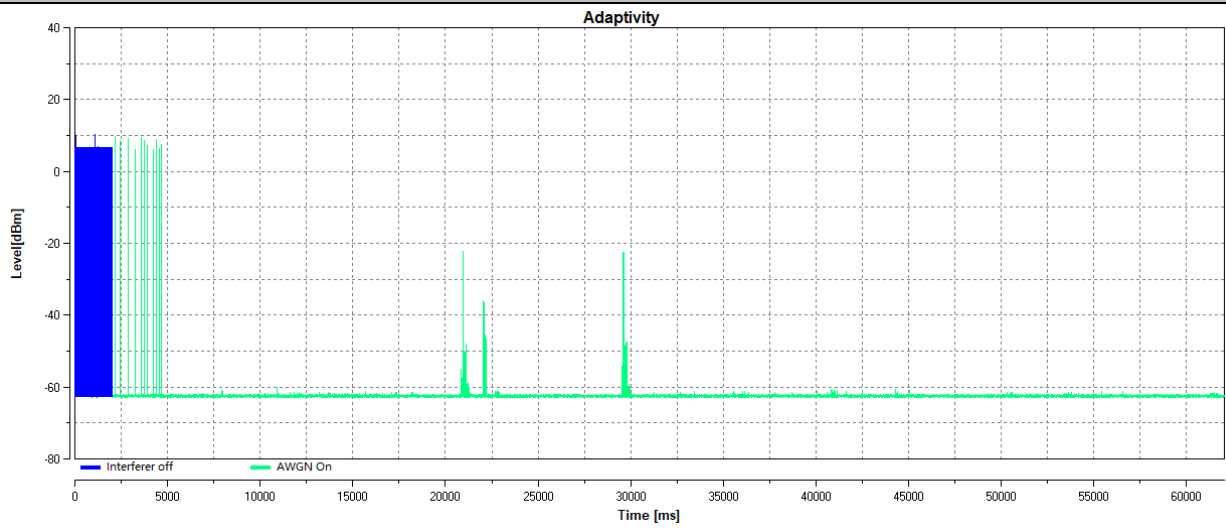

### Adaptivity\_LTE\_11ac HT20\_5180

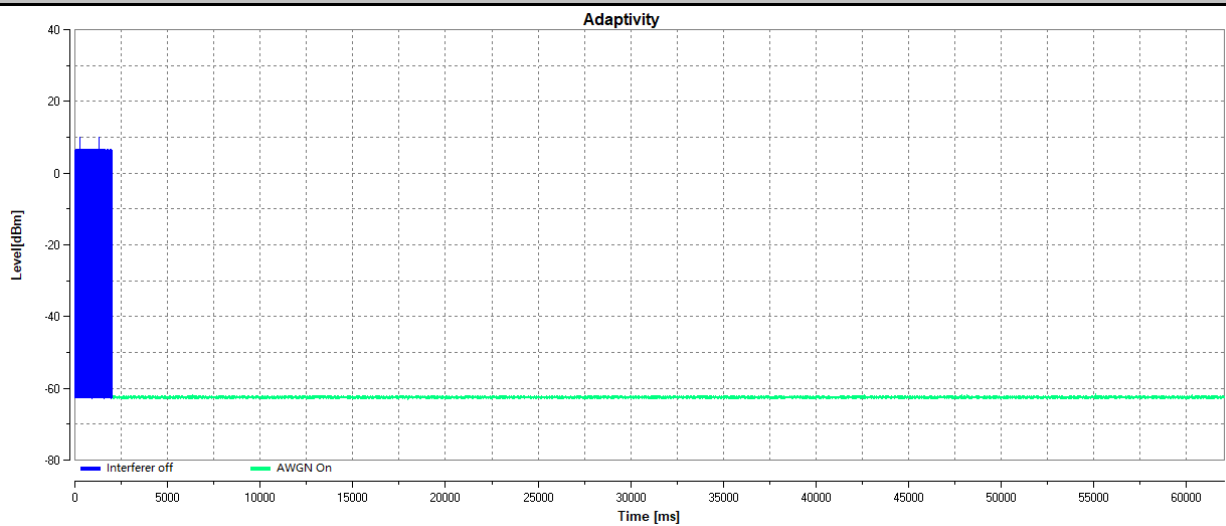



### Adaptivity\_OFDM\_11ac HT20\_5180

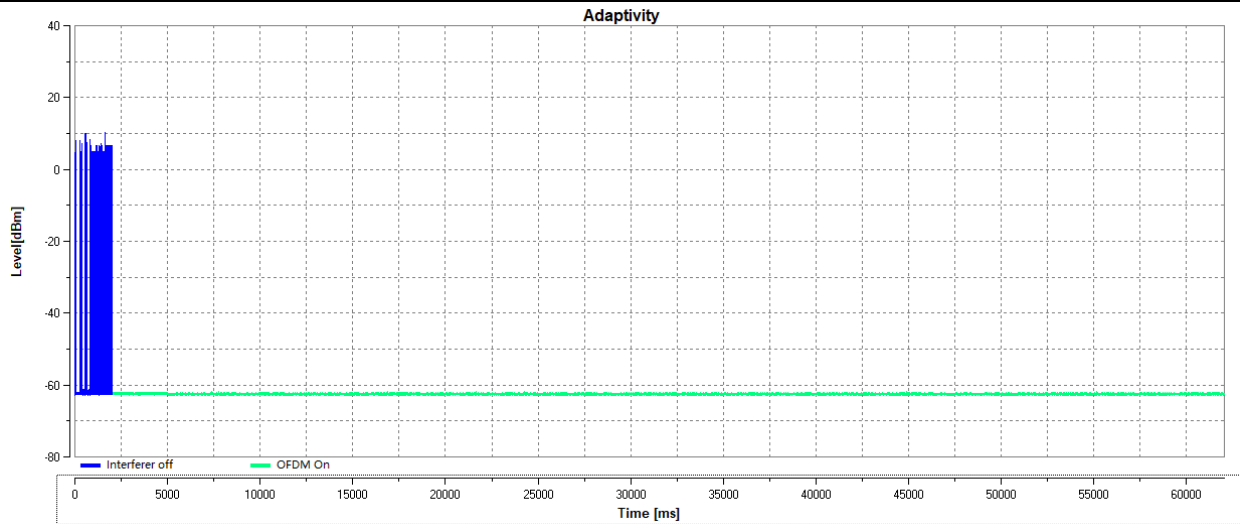

### Adaptivity\_AWGN\_11ac HT20\_5180

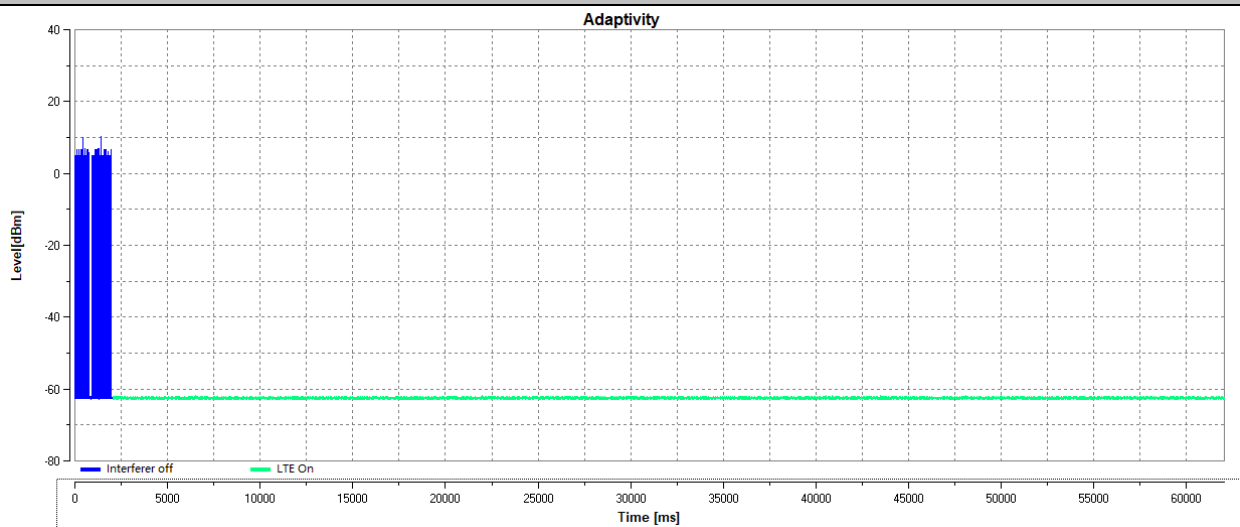

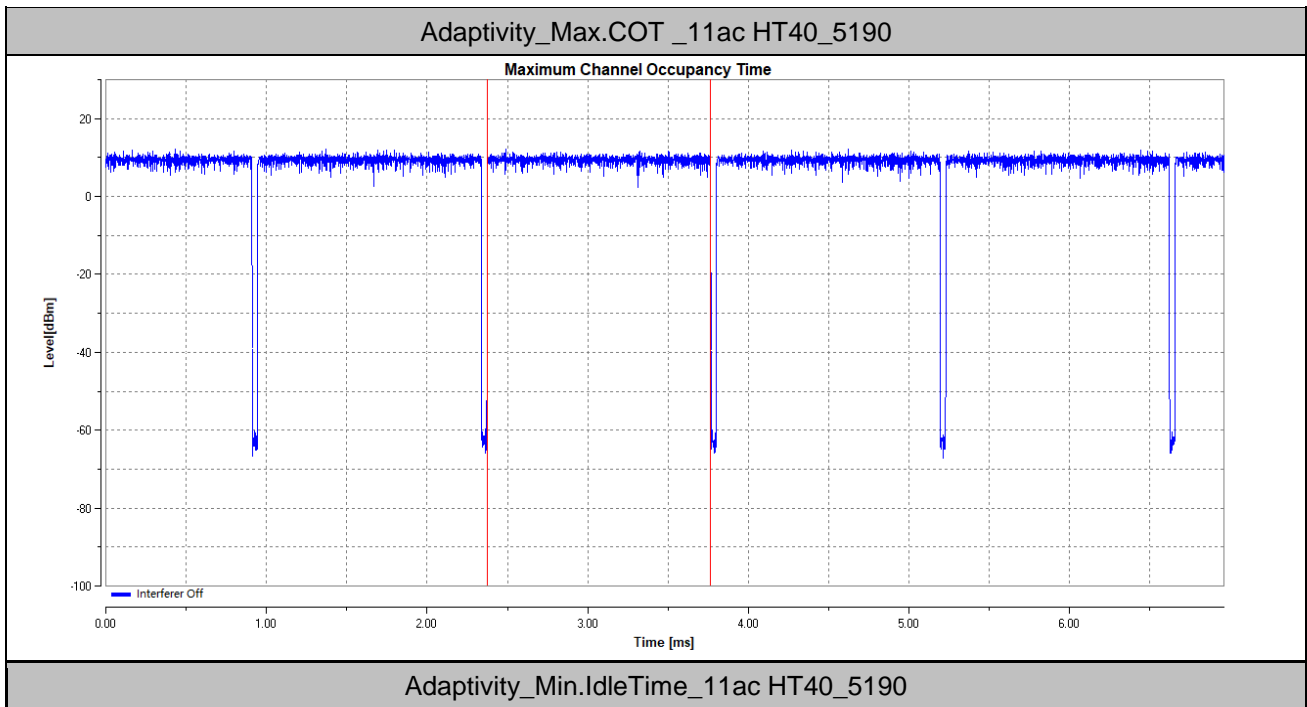



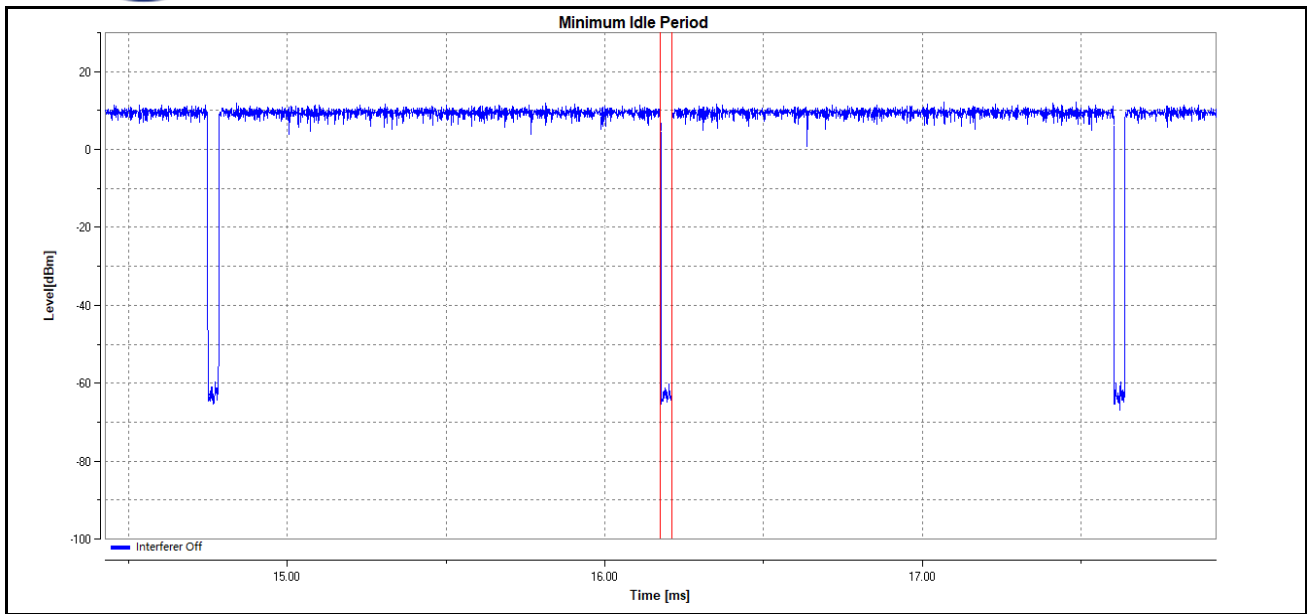

Adaptivity\_Idle Period probability\_11ac HT40\_5190

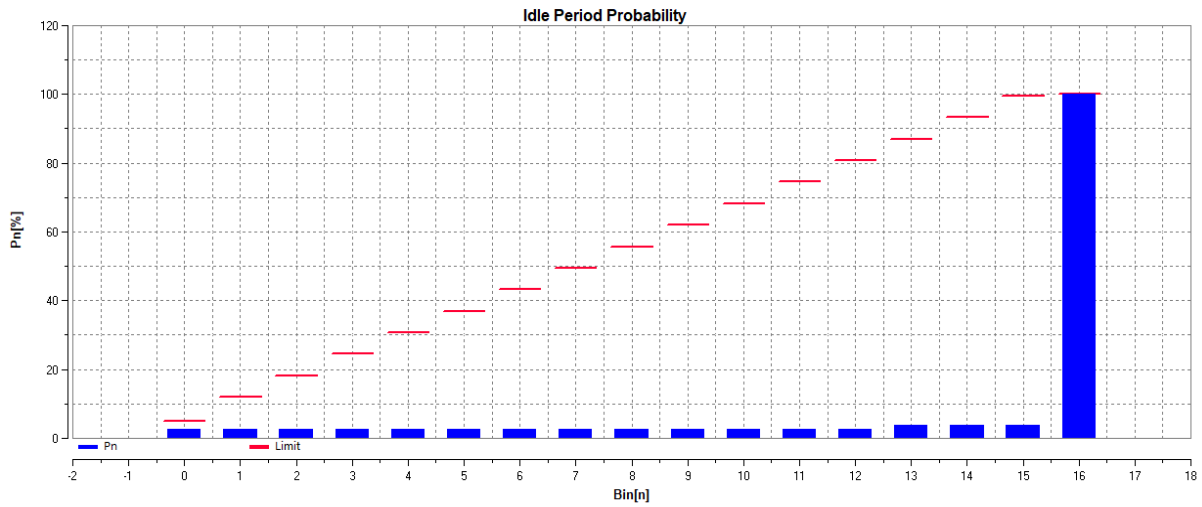

n	0	1	2	3	4	5	6	7	8	9	10	11	12	13	14	15	16
$S[n]$	26	1	0	0	0	0	0	0	0	0	0	0	0	10	0	0	984
$P[n]$	2.6	2.7	2.7	2.7	2.7	2.7	2.7	2.7	2.7	2.7	2.7	2.7	2.7	3.7	3.7	3.7	100
Limit	5	12	18.25	24.5	30.75	37	43.25	49.5	55.75	62	68.25	74.5	80.75	87	93.25	99.5	100

### Adaptivity\_Max.COT\_11ac HT80\_5210

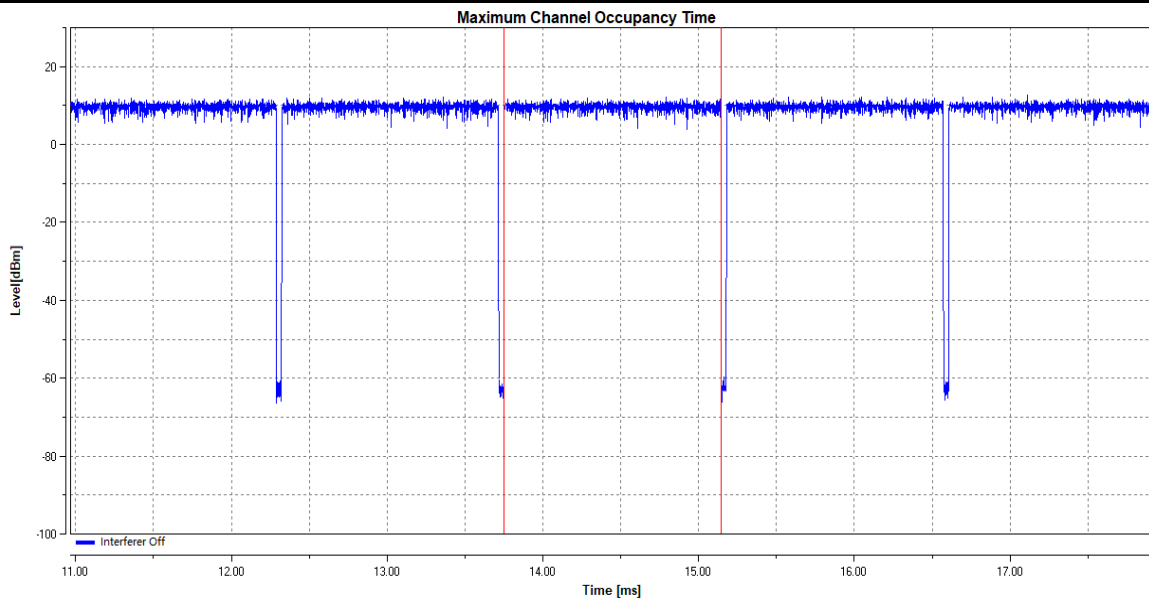



Adaptivity\_Min.IdleTime\_11ac HT80\_5210

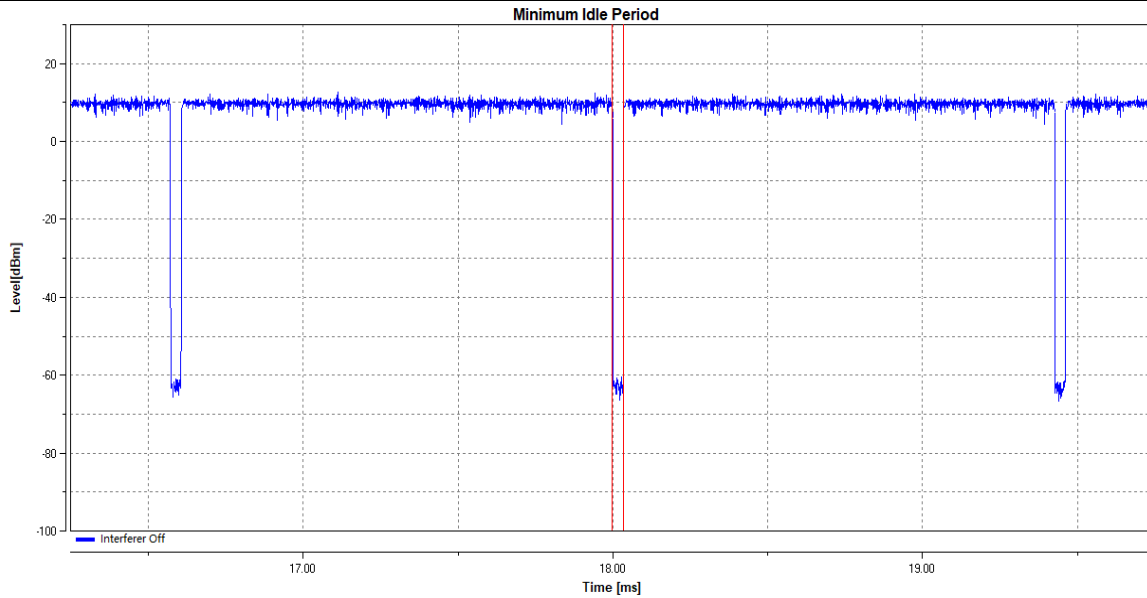

Adaptivity\_Idle Period probability\_11ac HT80\_5210

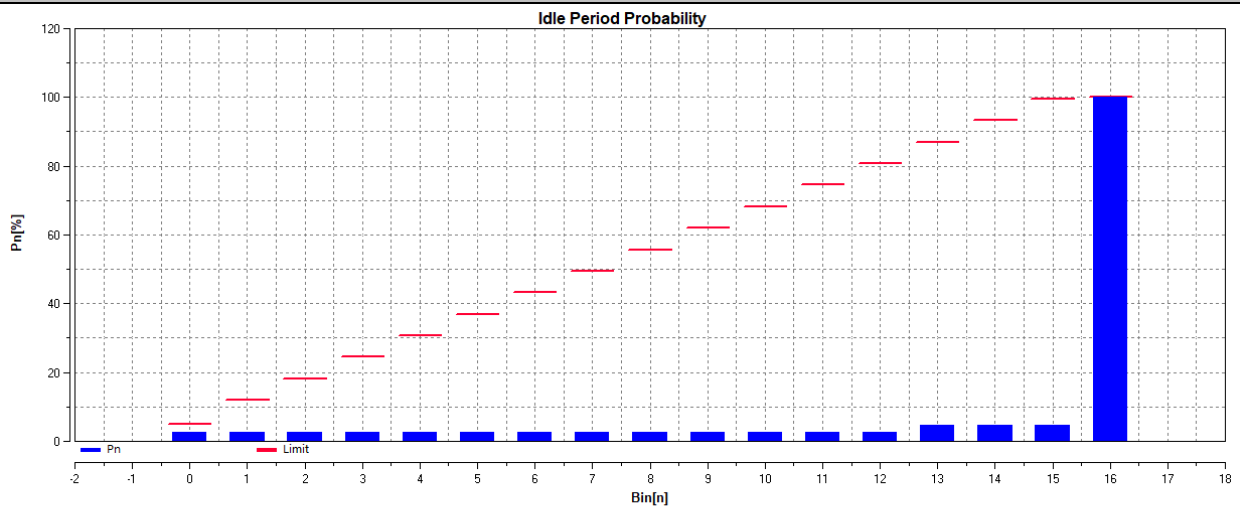

n	0	1	2	3	4	5	6	7	8	9	10	11	12	13	14	15	16
B[n]	27	0	0	0	0	0	0	0	0	0	0	0	0	20	0	1	960
P[n]	2.68	2.68	2.68	2.68	2.68	2.68	2.68	2.68	2.68	2.68	2.68	2.68	2.68	4.66	4.66	4.76	100
Limit	5	12	18.25	24.5	30.75	37	43.25	49.5	55.75	62	68.25	74.5	80.75	87	93.25	99.5	100



TEST PLOT

Adaptivity\_LTE\_TNVN\_11ac HT40\_5190

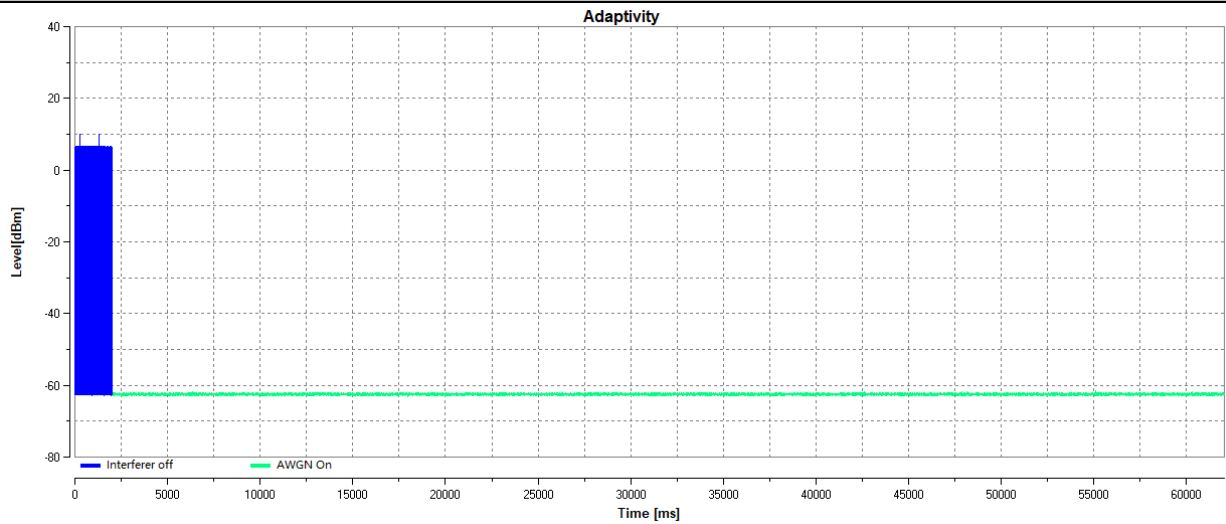

Adaptivity\_OFDM\_TNVN\_11ac HT40\_5190

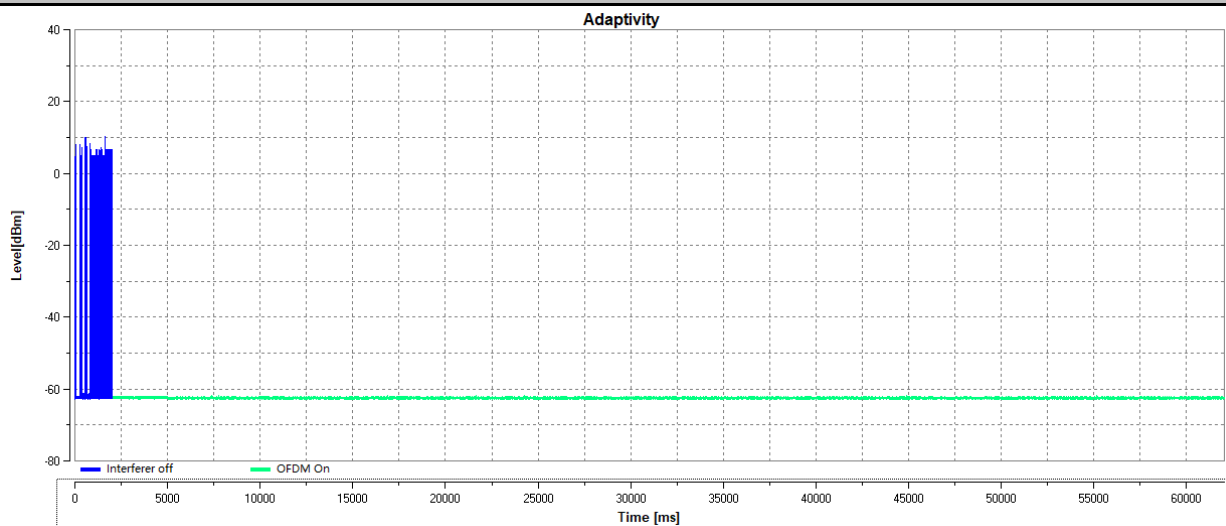



Adaptivity\_AWGN\_11ac HT40\_5190

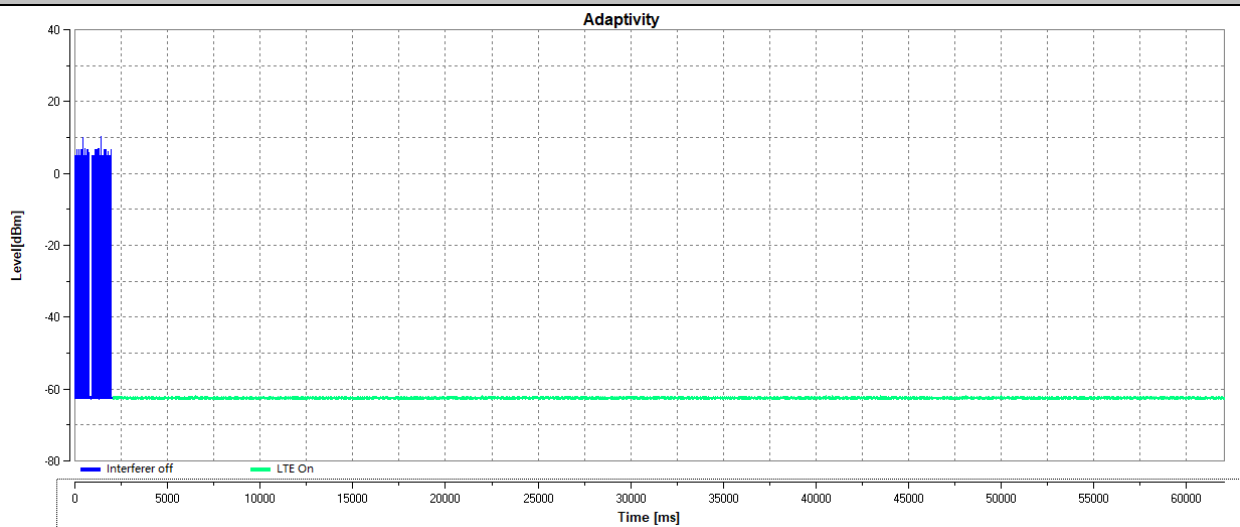

Adaptivity\_LTE\_11ac HT80\_5210

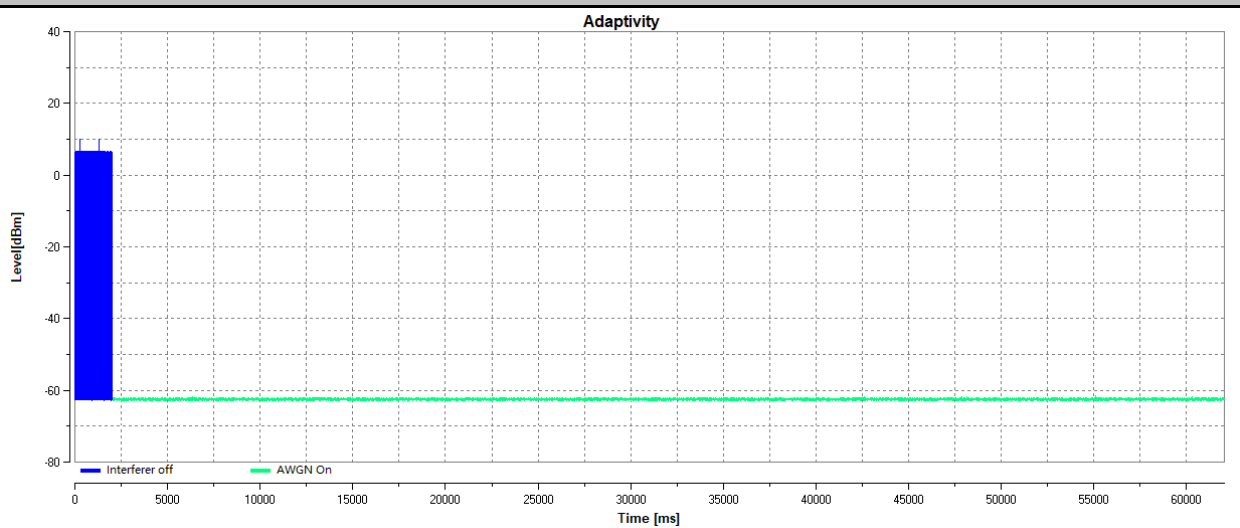



### Adaptivity\_OFDM\_11ac HT80\_5210

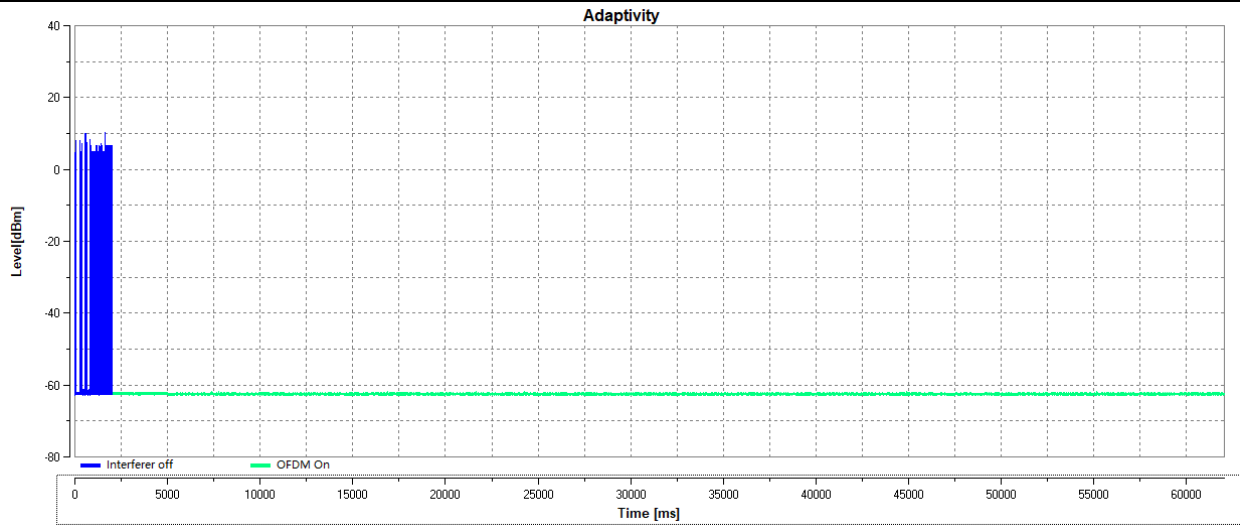

### Adaptivity\_AWGN\_11ac HT80\_5210

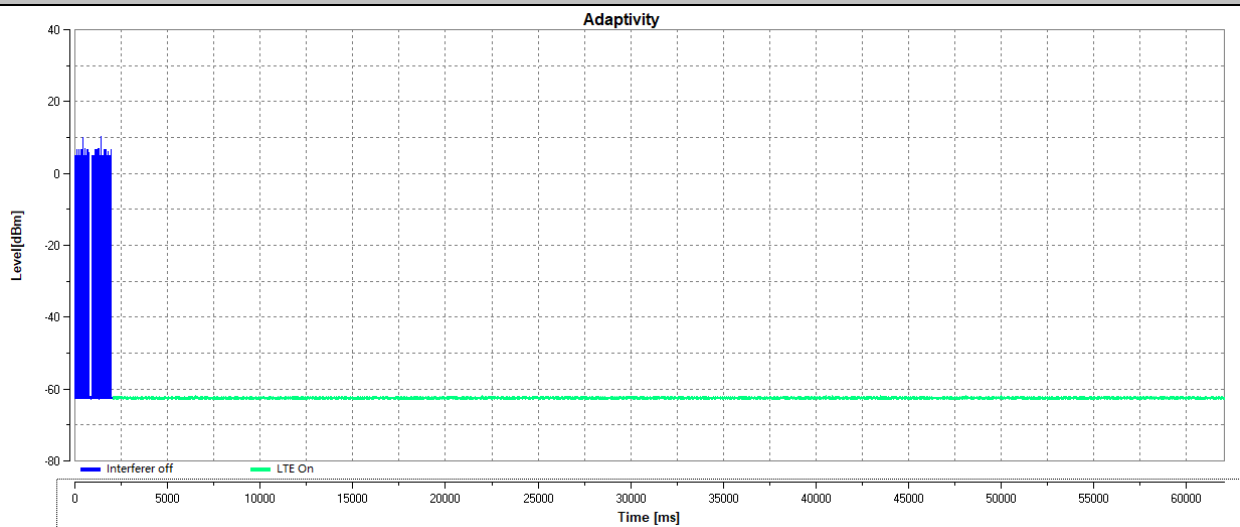



## 5.8. Receiver Blocking

### Limits

#### ETSI EN 301 893 Sub-4.2.8.4

While maintaining the minimum performance criteria as defined in clause 4.2.8.3, the blocking levels at specified frequency offsets shall be equal to or greater than the limits defined in table 9.

**Table 9: Receiver Blocking parameters**

Wanted signal mean power from companion device (dBm)	Blocking signal frequency (MHz)	Blocking signal power (dBm) (see note 2)		Type of blocking signal
		Master or Slave with radar detection (see table D.2, note 2)	Slave without radar detection (see table D.2, note 2)	
P <sub>min</sub> + 6 dB	5 100	-53	-59	Continuous Wave
P <sub>min</sub> + 6 dB	4 900 5 000 5 975	-47	-53	Continuous Wave

NOTE 1: P<sub>min</sub> is the minimum level of the wanted signal (in dBm) required to meet the minimum performance criteria as defined clause 4.2.8.3 in the absence of any blocking signal.

NOTE 2: The levels specified are levels in front of the UUT antenna. In case of conducted measurements, the same levels should be used at the antenna connector irrespective of antenna gain.

### TEST CONFIGURATION:

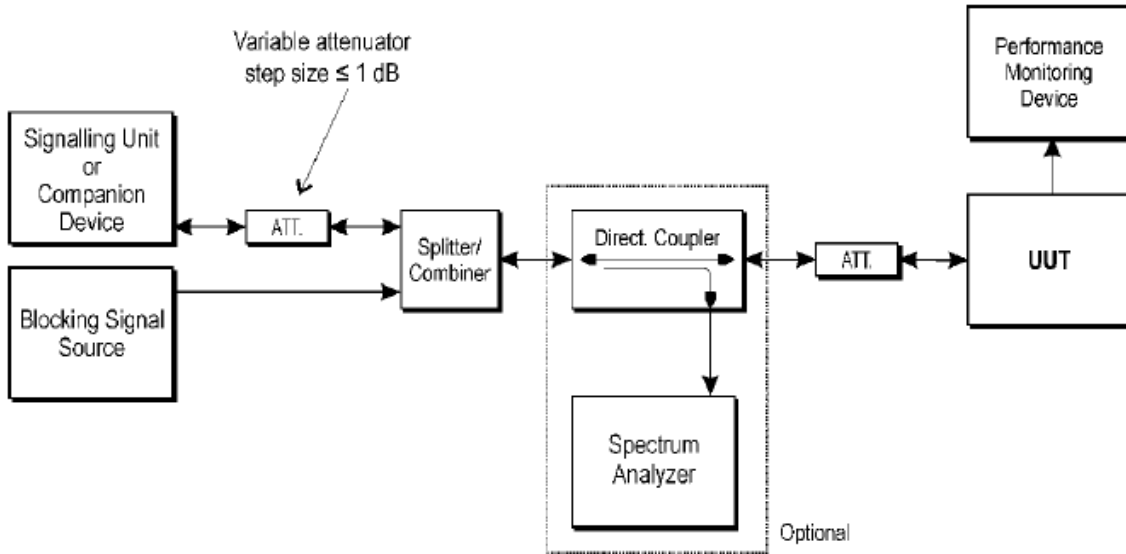

**TEST PROCEDURE**

Please refer to ETSI EN 301 893 Sub-clause 4.2.8.2 for the measurement method..

**TEST RESULTS**

Note:Both antenna A and B have been test,802.11a model cannot output Power at the same time.Only show the worst data of Antenna A

**5150-5250MHz Band I**

Normal mode:802.11a(HT-20)

Wanted signalmean powerfrom companiondevice (dBm)	Blocking signal frequency (MHz)	Blockingsignal power(dBm) CW	PER (%)	Limit (%)	Results
-64	5100	-59	0.57%	10	PASS
	4 900 5 000 5 975	-53	0.79%		PASS
			2.11%		PASS
			0.86%		PASS

**NOTE:**

- (1)The minimum performance criterion shall be a PER less than or equal to 10 %. The manufacturer may declarealternative performance criteria as long as that is appropriate for the intended use of the equipment (see clause 5.4.1.t)).
- (2)Pmin= -70dBm.

Normal mode:802.11n(HT-20)





Wanted signal mean power from companion device (dBm)	Blocking signal frequency (MHz)	Blocking signal power (dBm) CW	PER (%)	Limit (%)	Results
-64	5100	-59	0.96%	10	PASS
	4 900 5 000 5 975	-53	0.42%		PASS
			1.65%		PASS
			1.11%		PASS

NOTE:  
 (1) The minimum performance criterion shall be a PER less than or equal to 10 %. The manufacturer may declare alternative performance criteria as long as that is appropriate for the intended use of the equipment (see clause 5.4.1.t)).  
 (2) P<sub>min</sub> = -70 dBm.



Normal mode:802.11n(HT-40)

Wanted signal mean power from companion device (dBm)	Blocking signal frequency (MHz)	Blocking signal power (dBm) CW	PER (%)	Limit (%)	Results
-64	5100	-59	0.45%	10	PASS
	4 900 5 000 5 975	-53	0.16%		PASS
			0.05%		PASS
			-0.21%		PASS

NOTE:

(1) The minimum performance criterion shall be a PER less than or equal to 10 %. The manufacturer may declare alternative performance criteria as long as that is appropriate for the intended use of the equipment (see clause 5.4.1.t)).

(2) Pmin=-70dBm.

Normal mode:802.11ac(HT-20)

Wanted signal mean power from companion device (dBm)	Blocking signal frequency (MHz)	Blocking signal power (dBm) CW	PER (%)	Limit (%)	Results
-64	5100	-59	0.62%	10	PASS
	4 900 5 000 5 975	-53	0.66%		PASS
			2.01%		PASS
			0.90%		PASS

NOTE:

(1) The minimum performance criterion shall be a PER less than or equal to 10 %. The manufacturer may declare alternative performance criteria as long as that is appropriate for the intended use of the equipment (see clause 5.4.1.t)).

(2) Pmin=-70dBm.



Normal mode:802.11ac(HT-40)

Wanted signal mean power from companion device (dBm)	Blocking signal frequency (MHz)	Blocking signal power (dBm) CW	PER (%)	Limit (%)	Results
-64	5100	-59	0.59%	10	PASS
	4900 5000 5975	-53	0.43%		PASS
			2.12%		PASS
			0.84%		PASS

NOTE:

(1) The minimum performance criterion shall be a PER less than or equal to 10 %. The manufacturer may declare alternative performance criteria as long as that is appropriate for the intended use of the equipment (see clause 5.4.1.t)).

(2) Pmin=-70dBm.

Normal mode:802.11ac(HT-80)

Wanted signal mean power from companion device (dBm)	Blocking signal frequency (MHz)	Blocking signal power (dBm) CW	PER (%)	Limit (%)	Results
-64	5100	-59	1.01%	10	PASS
	4900 5000 5975	-53	0.72%		PASS
			1.71%		PASS
			0.79%		PASS

NOTE:

(1) The minimum performance criterion shall be a PER less than or equal to 10 %. The manufacturer may declare alternative performance criteria as long as that is appropriate for the intended use of the equipment (see clause 5.4.1.t)).

(2) Pmin=-70dBm.



**5250-5350MHz Band II**

Normal mode:802.11a(HT-20)

Wanted signal mean power from companion device (dBm)	Blocking signal frequency (MHz)	Blockingsignal power(dBm) CW	PER (%)	Limit (%)	Results
-64	5100	-59	0.87%	10	PASS
	4 900 5 000 5 975	-53	0.80%		PASS
			2.12%		PASS
			0.87%		PASS

**NOTE:**

(1)The minimum performance criterion shall be a PER less than or equal to 10 %. The manufacturer may declare alternative performance criteria as long as that is appropriate for the intended use of the equipment (see clause 5.4.1.t)).  
 (2)Pmin= -70dBm.

Normal mode:802.11n(HT-20)

Wanted signal mean power from companion device (dBm)	Blocking signal frequency (MHz)	Blockingsignal power(dBm) CW	PER (%)	Limit (%)	Results
-64	5100	-59	0.81%	10	PASS
	4 900 5 000 5 975	-53	0.68%		PASS
			1.72%		PASS
			0.87%		PASS

**NOTE:**

(1)The minimum performance criterion shall be a PER less than or equal to 10 %. The manufacturer may declare alternative performance criteria as long as that is appropriate for the intended use of the equipment (see clause 5.4.1.t)).  
 (2)Pmin=-70dBm.



Normal mode:802.11n(HT-40)

Wanted signal mean power from companion device (dBm)	Blocking signal frequency (MHz)	Blockingsignal power(dBm) CW	PER (%)	Limit (%)	Results
-64	5100	-59	0.90%	10	PASS
	4 900 5 000 5 975	-53	0.63%		PASS
			1.85%		PASS
			0.62%		PASS

NOTE:

(1)The minimum performance criterion shall be a PER less than or equal to 10 %. The manufacturer may declare alternative performance criteria as long as that is appropriate for the intended use of the equipment (see clause 5.4.1.t)).

(2)Pmin=-70dBm.

Normal mode:802.11ac(HT-20)

Wanted signal mean power from companion device (dBm)	Blocking signal frequency (MHz)	Blockingsignal power(dBm) CW	PER (%)	Limit (%)	Results
-64	5100	-59	0.58%	10	PASS
	4 900 5 000 5 975	-53	0.36%		PASS
			1.62%		PASS
			1.25%		PASS

NOTE:

(1)The minimum performance criterion shall be a PER less than or equal to 10 %. The manufacturer may declare alternative performance criteria as long as that is appropriate for the intended use of the equipment (see clause 5.4.1.t)).

(2)Pmin=-70dBm.



Normal mode:802.11ac(HT-40)

Wanted signal mean power from companion device (dBm)	Blocking signal frequency (MHz)	Blocking signal power (dBm) CW	PER (%)	Limit (%)	Results
-64	5100	-59	0.91%	10	PASS
	4 900 5 000 5 975	-53	0.93%		PASS
			1.45%		PASS
			1.22%		PASS

NOTE:

(1) The minimum performance criterion shall be a PER less than or equal to 10 %. The manufacturer may declare alternative performance criteria as long as that is appropriate for the intended use of the equipment (see clause 5.4.1.t)).

(2) Pmin=-70dBm.

Normal mode:802.11ac(HT-80)

Wanted signal mean power from companion device (dBm)	Blocking signal frequency (MHz)	Blocking signal power (dBm) CW	PER (%)	Limit (%)	Results
-64	5100	-59	0.92%	10	PASS
	4 900 5 000 5 975	-53	0.15%		PASS
			2.01%		PASS
			0.75%		PASS

NOTE:

(1) The minimum performance criterion shall be a PER less than or equal to 10 %. The manufacturer may declare alternative performance criteria as long as that is appropriate for the intended use of the equipment (see clause 5.4.1.t)).

(2) Pmin=-70dBm.



**5470-5725MHz Band III**

Normal mode:802.11a(HT-20)

Wanted signal mean power from companion device (dBm)	Blocking signal frequency (MHz)	Blocking signal power (dBm) CW	PER (%)	Limit (%)	Results
-64	5100	-59	0.79%	10	PASS
	4 900 5 000 5 975	-53	0.36%		PASS
			2.18%		PASS
			0.72%		PASS

**NOTE:**

(1) The minimum performance criterion shall be a PER less than or equal to 10 %. The manufacturer may declare alternative performance criteria as long as that is appropriate for the intended use of the equipment (see clause 5.4.1.t)).

(2) P<sub>min</sub> = -70dBm.

Normal mode:802.11n(HT-20)

Wanted signal mean power from companion device (dBm)	Blocking signal frequency (MHz)	Blocking signal power (dBm) CW	PER (%)	Limit (%)	Results
-64	5100	-59	0.83%	10	PASS
	4 900 5 000 5 975	-53	0.57%		PASS
			1.69%		PASS
			0.62%		PASS

**NOTE:**

(1) The minimum performance criterion shall be a PER less than or equal to 10 %. The manufacturer may declare alternative performance criteria as long as that is appropriate for the intended use of the equipment (see clause 5.4.1.t)).

(2) P<sub>min</sub> = -70dBm.



Normal mode:802.11n(HT-40)

Wanted signal mean power from companion device (dBm)	Blocking signal frequency (MHz)	Blocking signal power (dBm) CW	PER (%)	Limit (%)	Results
-64	5100	-59	0.61%	10	PASS
	4 900 5 000 5 975	-53	0.39%		PASS
			2.19%		PASS
			0.82%		PASS

NOTE:

(1) The minimum performance criterion shall be a PER less than or equal to 10 %. The manufacturer may declare alternative performance criteria as long as that is appropriate for the intended use of the equipment (see clause 5.4.1.t)).

(2) Pmin=-70dBm.

Normal mode:802.11ac(HT-20)

Wanted signal mean power from companion device (dBm)	Blocking signal frequency (MHz)	Blocking signal power (dBm) CW	PER (%)	Limit (%)	Results
-64	5100	-59	0.56%	10	PASS
	4 900 5 000 5 975	-53	0.69%		PASS
			1.66%		PASS
			0.95%		PASS

NOTE:

(1) The minimum performance criterion shall be a PER less than or equal to 10 %. The manufacturer may declare alternative performance criteria as long as that is appropriate for the intended use of the equipment (see clause 5.4.1.t)).

(2) Pmin=-70dBm.





Normal mode:802.11ac(HT-40)

Wanted signal mean power from companion device (dBm)	Blocking signal frequency (MHz)	Blockingsignal power(dBm) CW	PER (%)	Limit (%)	Results
-64	5100	-59	0.81%	10	PASS
	4 900 5 000 5 975	-53	0.46%		PASS
			2.13%		PASS
			0.95%		PASS

NOTE:

(1)The minimum performance criterion shall be a PER less than or equal to 10 %. The manufacturer may declare alternative performance criteria as long as that is appropriate for the intended use of the equipment (see clause 5.4.1.t)).

(2)Pmin=-70dBm.

Normal mode:802.11ac(HT-80)

Wanted signal mean power from companion device (dBm)	Blocking signal frequency (MHz)	Blockingsignal power(dBm) CW	PER (%)	Limit (%)	Results
-64	5100	-59	0.81%	10	PASS
	4 900 5 000 5 975	-53	0.47%		PASS
			1.92%		PASS
			0.87%		PASS

NOTE:

(1)The minimum performance criterion shall be a PER less than or equal to 10 %. The manufacturer may declare alternative performance criteria as long as that is appropriate for the intended use of the equipment (see clause 5.4.1.t)).

(2)Pmin=-70dBm.



## 5.9. Geo-location capability

### **Requirement**

Geo-location capability is a feature of the RLAN device to determine its geographical location with the purpose to configure itself according to the regulatory requirements applicable at the geographical location where it operates. The geo-location capability may be present in the equipment or in an external device (temporary) associated with the equipment operating at the same geographical location during the initial power up of the equipment. The geographical location may also be available in equipment already installed and operating at the same geographical location.

The geographical location determined by the equipment as defined in the above shall not be accessible to the user.

### **Result**

This requirement only applies to equipment with geo-location capability, and the EUT do not support this function. So this requirement is not applicable for the EUT.



## **6. Test Setup Photos of the EUT**



## **7. External and Internal Photos of the EUT**

Reference to the test report No.ATT2020SZ061005E2

.....**End of Report**.....