



## 2-Wire

Video Intercom System  
2017~2018 Catalogue

FUTURA  
digital

## Global Sales Network

**GUANGZHOU VIDEO-TECH ELECTRONICS CO.,LTD** was founded in 1999 to specialize in the R&D, production and sale of video door phones, we concentrate on developing unique system with V-TECH characters, and after experiencing a rapidly rising in the past ten years, Video-Tech has established many distributor branches all over the world, and we are gradually becoming one of the most popular brands for door-entry system.



CE FC RoHS REACH

## INDEX

LATEST LAUNCH	2
MONITORS	6
DOOR STATIONS	12
SYSTEM DESCRIPTION	18
TYPICAL CONFIGURATION	20
FUNCTIONAL FEATURES	26
DIAGRAM AND DISTANCE	30
PRODUCT LIST(IM)	32
PRODUCT LIST(DS)	34
PRODUCT LIST(AC)	36
DIMENSIONS	38

## LATEST LAUNCH

### DX471

7 inch TFT  
Touch screen  
Wi-Fi monitor

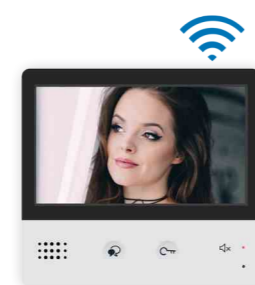

### DX439

4.3 inch TFT  
Touch screen  
Wi-Fi monitor

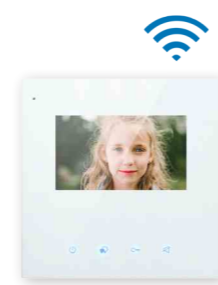

### DT433

4.3 inch TFT  
Touch sensor buttons  
Economic design

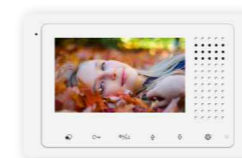

### DT608

Stainless steel panel  
Max.32 buttons  
Fisheye camera



### DMR50

5 inch touch screen  
Fisheye camera  
Proximity access



# WIFI SOLUTION IN HOME SYSTEM



## System diagram with mixed DT&DX monitors

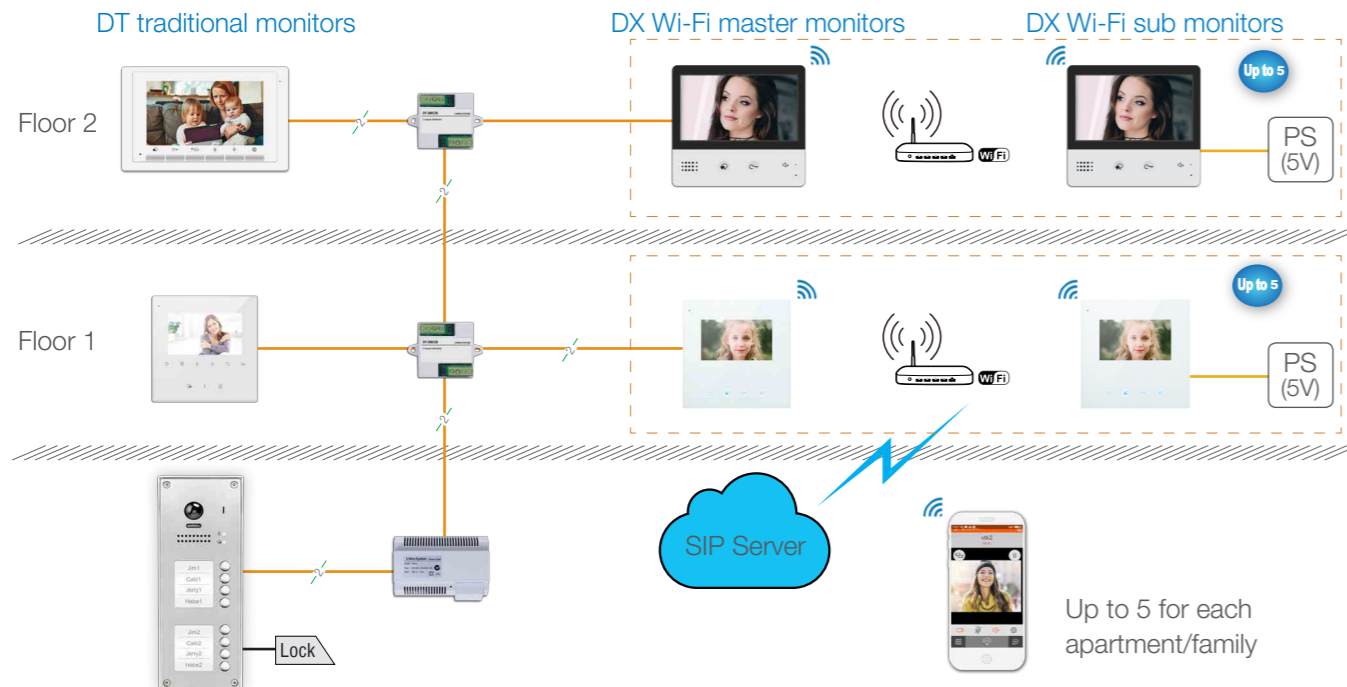

## System Features



## MONITOR DX439

4.3 inch screen

### Compact Wi-Fi Monitor

Simple, modern & fashionable design. Thanks to its intuitive menu, users could easily control each function inside monitor step by step.

- 4.3 inch touch screen
- 3mm tempered glass panel
- Sensitive touch sensor buttons
- Simple and intuitive menu style

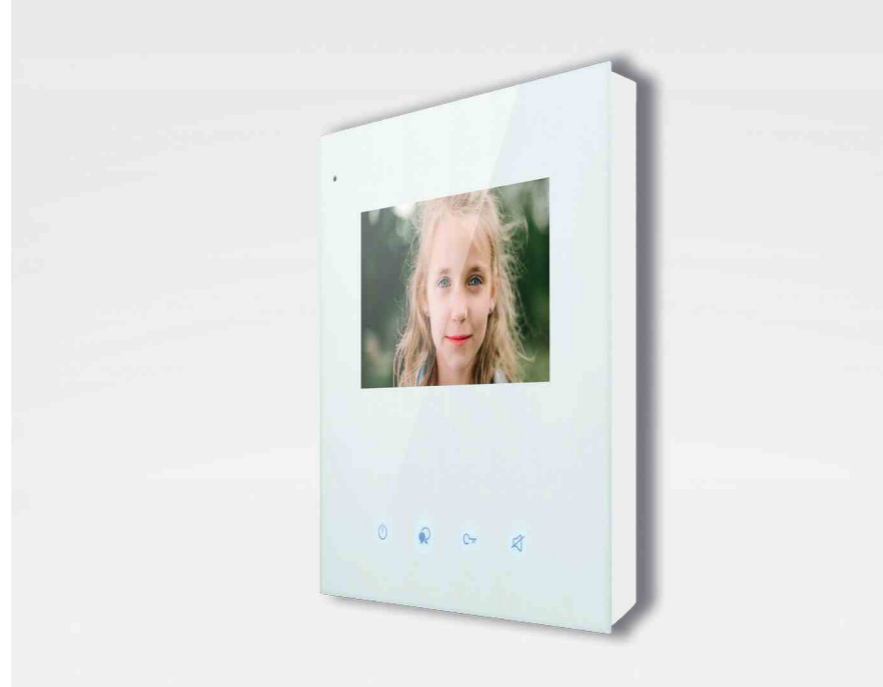

## MONITOR DX471

7 inch screen

### Big TFT Wi-Fi Monitor

Big TFT display with friendly touch screen operation, logic tree-menu structure for a great experience.

- 7 inch touch screen
- Wi-Fi monitor with 2 wire connection
- Sensitive touch sensor button
- High quality plastic front panel

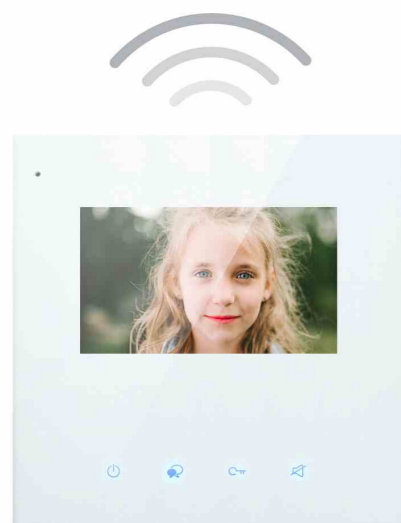
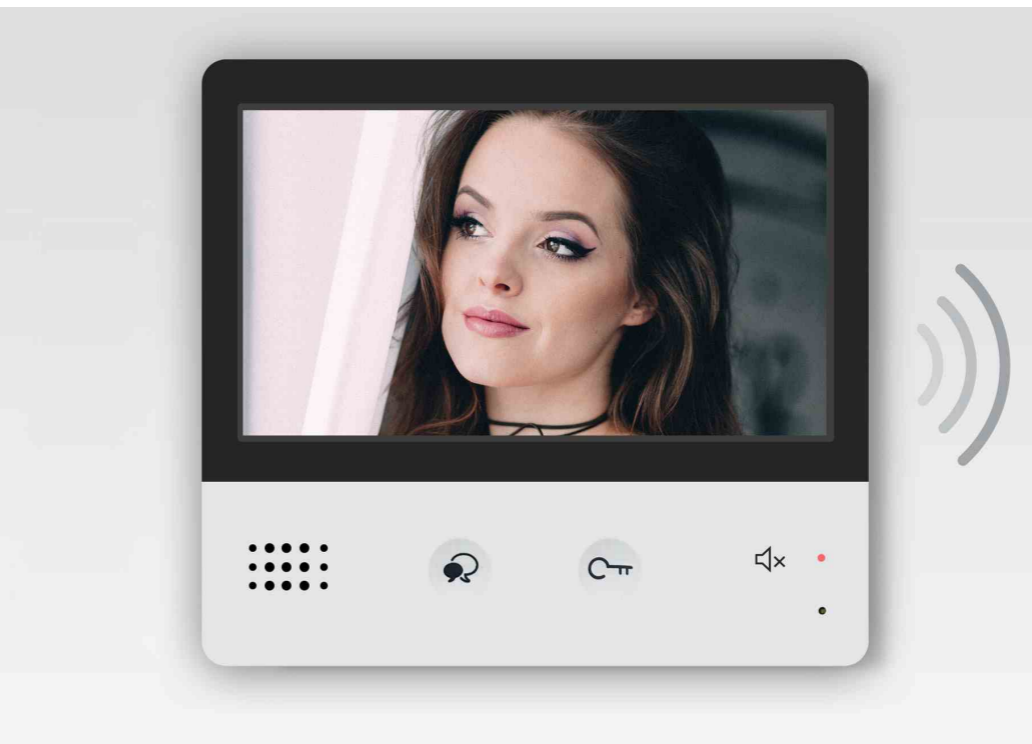
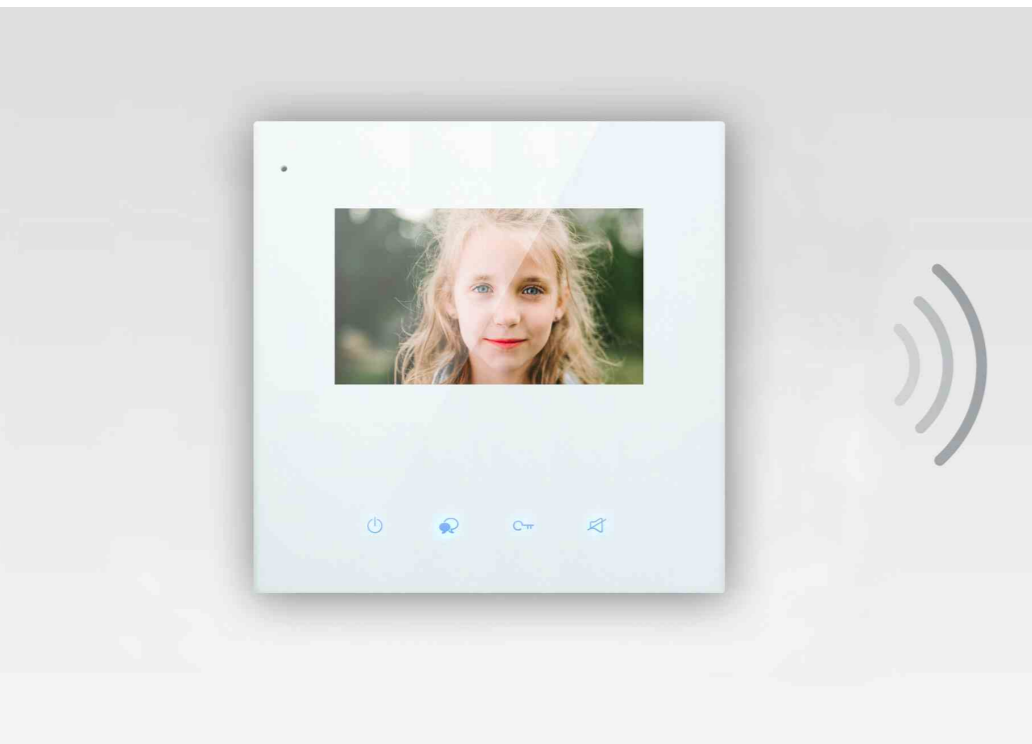

Wi-Fi sub monitor

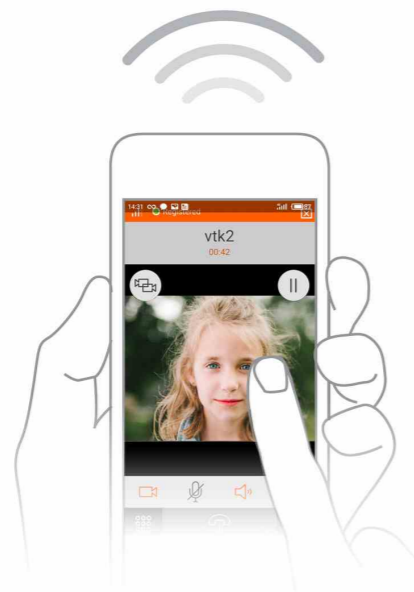

### Main functions

**Call divert**  
Call divert to smart phone

**Surveillance**  
CCTV camera monitoring

**Wi-Fi sub monitor connection(WS439)**  
4.3 inch same style design wireless monitor with photo frame function

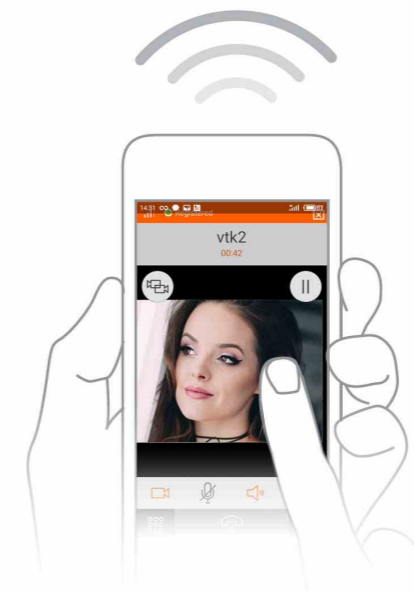

### Main functions

**Memory**  
Picture memory or video memory via SD card

**Call divert**  
Call divert to smart phone

**Classic kit**  
Villa kit with DT607 outdoor station (ref. to Page 21)

# MONITOR DT433

4.3 inch screen

## 4.3" Project Monitor

Classics design without any screw assembling, special buckled back cover mounting for more convenience in mounting

- 4.3 inch TFT screen
- Touch button design with visual sweep
- Economic project monitor
- Ultra thin design(17mm)
- No screw assembling & no bracket



# MONITOR DT17

7 inch screen

## 7" Project Monitor

One to one button-menu operation guide, not only improves friendliness of operation, but also supplies a shortcut for functional response.

- Ultra thin design
- Dummy mechanical button-layer design
- Sensitive touch sensor button
- High qualified ABS plastic with signal white color
- Simple and intuitive menu style



### Main functions

- Memory & call divert**  
Memory function and call divert via DT-IPG(V2)
- Actuator via DT-RLC**  
Light control  
2nd lock control
- Surveillance**  
CCTV camera monitoring
- Call guard unit**  
Intercom with guard person



### Main functions

- Communication**  
Intercom neighbor conversation  
Inner call family member conversation
- Actuator via DT-RLC**  
Light control  
2nd lock control
- Surveillance**  
CCTV camera monitoring
- Peripheral devices**  
Door bell & Ringer connection

# MONITOR DT37

7 inch screen

## Hands free Pad-monitor

Pad design with color icon menu, powerful AIO products with strongest functions, such as message, SMS, max.16 languages

- 7 inch TFT with touch screen
- Aluminum front panel
- Magnetic bracket
- Colorful bar touch area
- Ultra-thin Pad design



# MONITOR DT47

7 inch screen

## Capacitive TFT Monitor

Sensitive touch screen operation with color flat icon menu design, high-fidelity audio guarantees great acoustic performance under hands free mode.

- 7 inch capacitive TFT
- Color icon menu
- Touch screen
- True glass panel
- Black or White housing choose

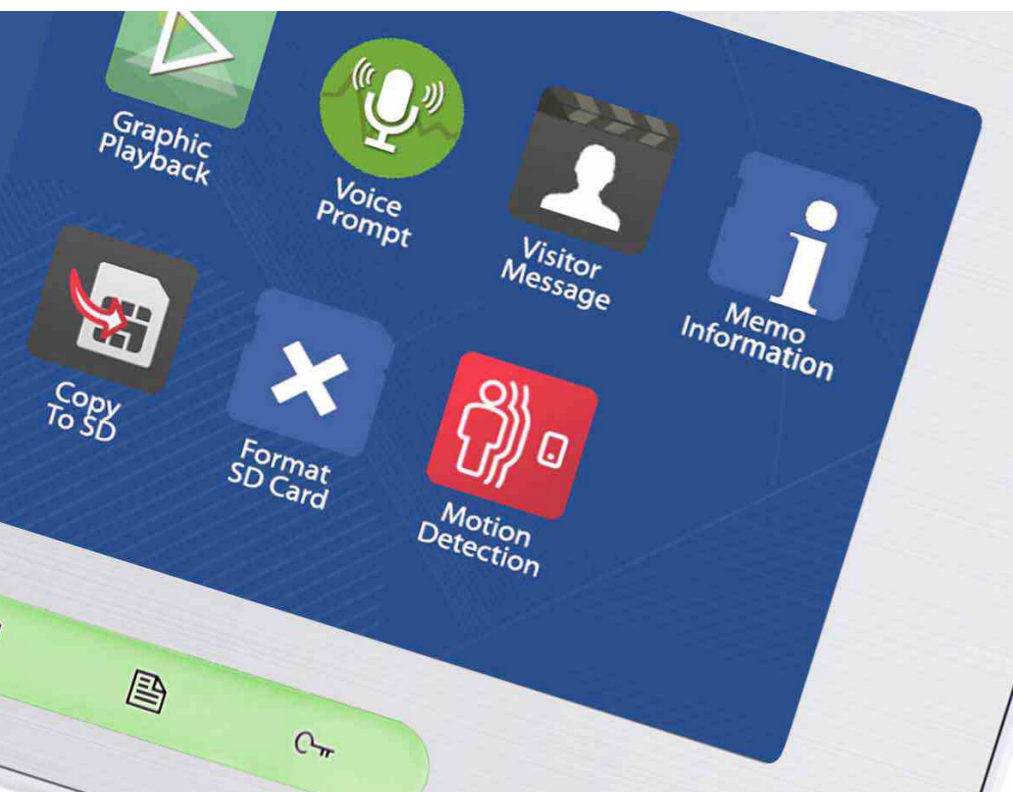
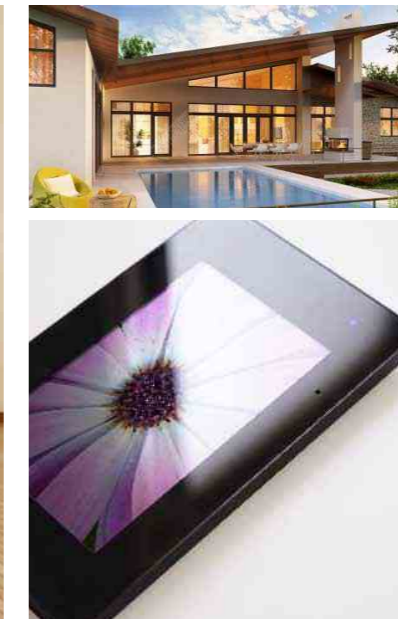

### Advanced functions

**Communication**  
 Intercom neighbor conversation  
 Inner call family member conversation  
 SMS short message between monitors

**Home away**  
 Voice message  
 Picture/video memory

**Surveillance**  
 CCTV camera monitoring  
 Image quad split display  
 Pan view display by manually

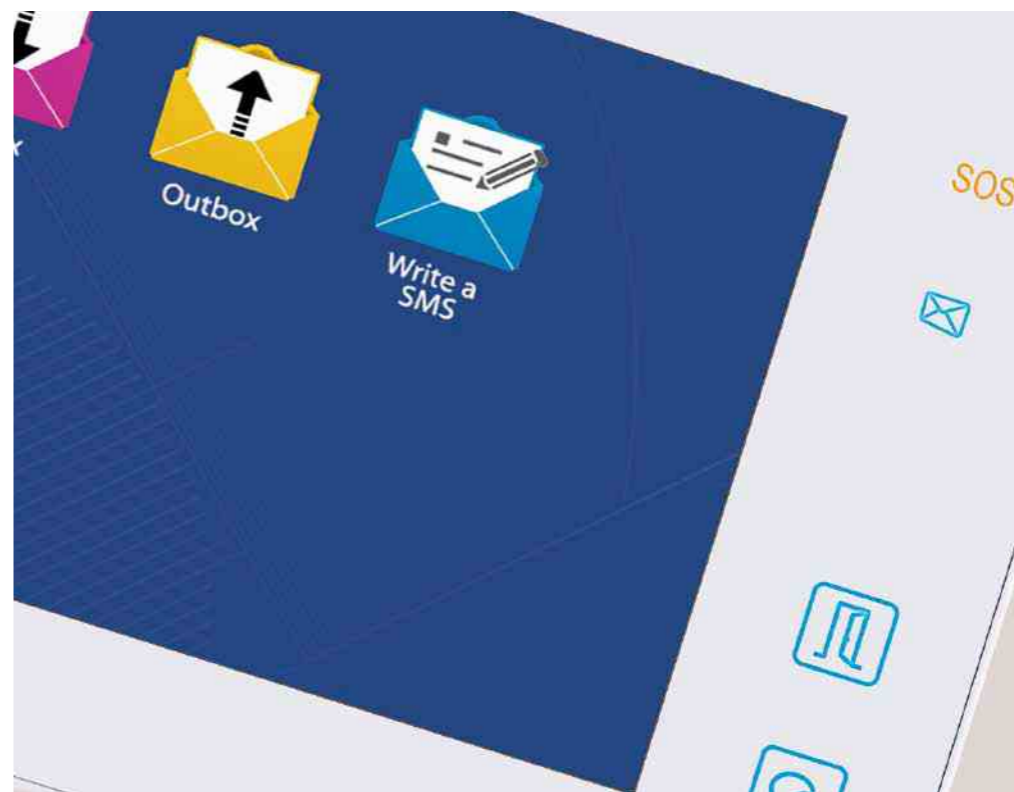

### Advanced functions

**Actuator via DT-RLC**  
 Light control  
 2nd lock control

**Peripheral devices**  
 Door bell & Ringer connection  
 Local power connection

**Customize**  
 Max. 16 languages embedded  
 UI customization

## DOOR STATION DT601

170° fisheye camera



### Fisheye lens outdoor station

Max.170° horizontal and 130° vertical view angle for a safety guarantee on the entry of the door, moreover, touch keypad and proximity access control for passive unlock.

- Stainless steel housing
- Touch sensor keypad
- 3mm glass window
- IP44 waterproof
- Surface & Flush mounting

### Multiple access control

#### Password access control

Support 20 sets password for Lock1 Lock2.

#### Proximity access control

UP to 320 RFID accesses for Lock1.



## DOOR STATION DT607

170° fisheye camera



### Outdoor station with max.4 buttons

Villa and apartment working mode for varied requirements, fisheye and normal camera lens for choose.

- Zinc alloy housing
- Working state indicators
- Big nameplate window
- 1~4 push buttons
- IP44 waterproof
- Surface & Flush mounting

### Functional Features

Max.170° fisheye lens

105° lens for optional

Tag proximity access

UP 320 RFID

Villa & apartment mode

Audio version for choose

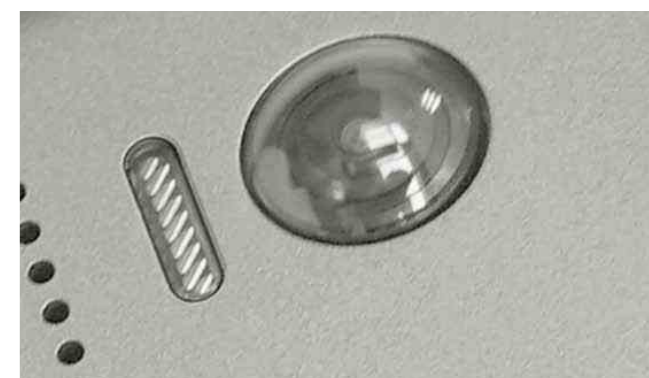

## DOOR STATION DT608

170° fisheye camera

### Direct push-button outdoor station

- 2mm Stainless steel panel
- Work-state indicators
- 28mm thickness body
- Surface mounting by rainy hook
- IP 44 waterproof



## DOOR STATION DMR50

170° fisheye camera

### Luxury touch TFT outdoor station

- Stainless steel housing
- 2.5mm glass panel
- Fisheye camera
- 5 inch TFT with HD display
- Full touch screen operation

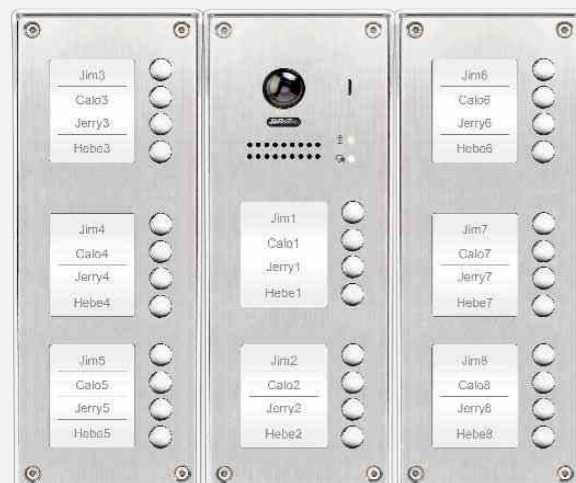
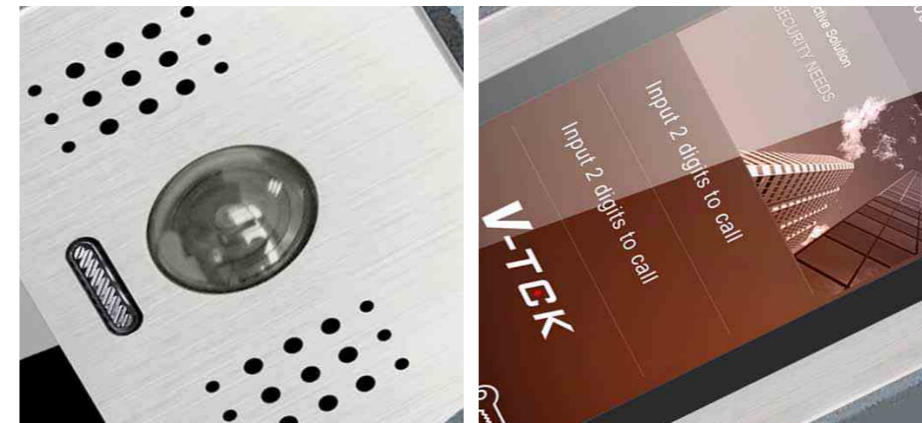

### Functional features

- Max. 170° fisheye lens  
105° lens for optional
- Max. 32 push buttons via extension
- Tag proximity supports
- Mechanical keypad(customized)

### Functional features

- Max. 170° fisheye lens
- User define menu
- Multi calling mode
- Name list management
- Wi-Fi connection(Reserved)





## DOOR STATION DMR21

170° fisheye camera

### Modularized outdoor station

- Stainless steel housing
- Work-state indicators
- Multi panels extension
- Hidden programming button
- Functional module design
- Flush mounting



#### DMR21-Modules

All module can work coordinately or separately



#### Functional features

Max.170° fisheye lens

Voice prompt function

Local language can be customized

Multi functional module

- ① Video/Audio entry module
- ② TFT display module
- ③ Tag proximity module
- ④ Touch keypad module
- ⑤ Information module

## DOOR STATION DMR18S

105° ARS camera

### Digital keypad outdoor station

- Full aluminium alloy panel
- 3.5 inch TFT
- Mechanical keypad access
- Reliable proximity access
- Touch navigation button
- Surface & Flush mounting



#### Functional features

New menu-structure design  
Color icon menus

Synthesis language reminder  
Allow to make a voice to remind visitors

Large capacity  
Max.6368 apartments  
Can be played as common door station



# SYSTEM DESCRIPTION

2 wire non-polarity bus line

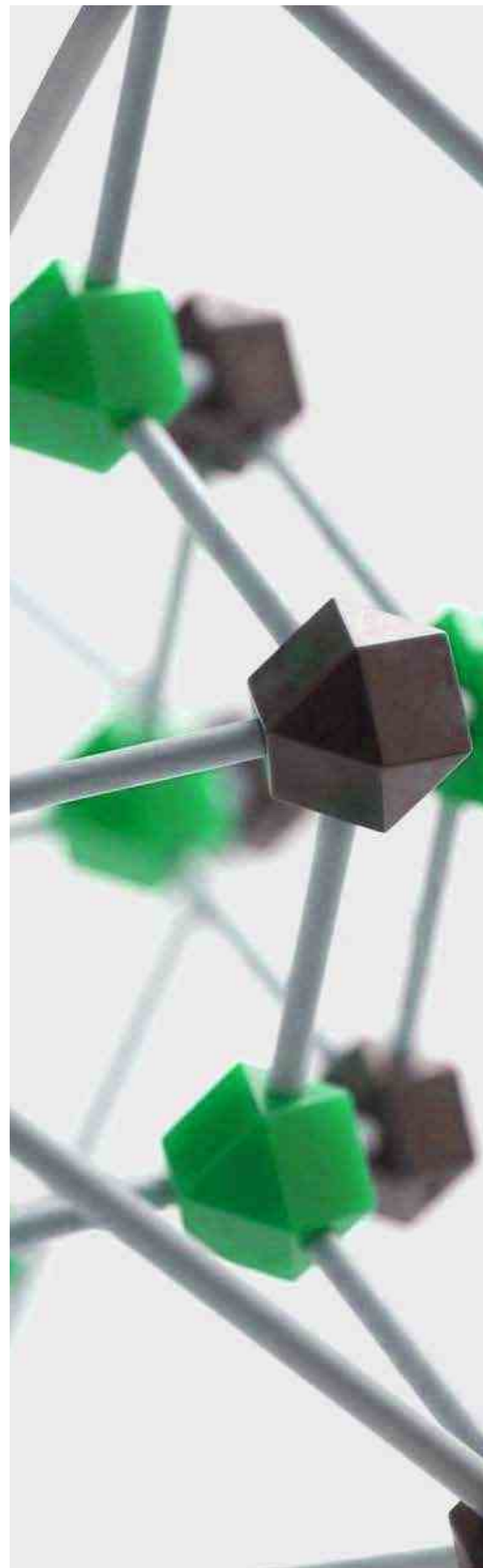

## Why 2-Easy?

Advantages of 2-wire system

✓ **All in One**

Power, audio, video and control signal, all transmitted by a 2-wire cable;



✓ **Non Polarity**

Never afraid of electric shock;



✓ **Functional Module**

Call transfer, Light control, Camera...etc. module;



✓ **Central Power Supply**

No black pigtail to home socket;



✓ **Flexible Cable**

Existing cable is available (parallel/ twisted cable, 18 gauge recommended);



✓ **Compatible Use**

The new Wi-Fi monitor can be compatible with the old ones;



✓ **IP Solution**

System extension and IP networking via DT-IPG;



✓ **Wi-Fi&mobile Application**

Wireless call divert to sub monitor or smart phone.



# TYPICAL SOLUTIONS

2 wire non-polarity bus line

	Legend	Application Range	Capacity
Standalone Video Intercom System		<b>Single family house</b> Video solution V1 Page 20-21	Max.16 V/A internal units
		<b>Apartment system</b> Audio, solution A1 Page 22	Max.32 Video internal units
<b>Apartment system</b> Video, solution V2 Page 23		Max.128 Audio phone	
Networked Video Intercom System		<b>High-rise building</b> Video, solution N1, Page 24	Max.199 floor gateway/riser Max.6368 monitors
		<b>Residential complex</b> Video, solution N2, Page 25	Max.32 common door stations Max.32 Guard units Max.199 subsystems

Low Labor Cost Easy to configure the system

Platform Development Villa- Apartment universal

Self Learning Easy to learn how to set up the system



Saving time,  
Getting more...

# V1: SINGLE FAMILY APPLICATION(FUNCTIONAL KIT)

## DT37MG Video KIT



### Monitor:

- 7 inch color TFT screen
- Touch screen operation
- Colorful touch sensor bar
- SMS & message function
- Pan view display with scanning
- Picture memory or video memory via SD card
- Call transfer via DT-IPG(V2)

### Outdoor station

- 170 degree fisheye high resolution camera
- Waterproof nameplate with blue light background
- Anti-tamper screw installation
- Full stainless steel materials design
- Keypad password / Proximity access control
- IP44 strong waterproof

	Outdoor Option	Monitor Option
Surface mounted		
Flush mounted		

Name	Outdoor	Indoor	Power Supply
<a href="#">DK3701-KP</a> 1 Way Keypad Access Control Video Kit	DT601/KP-FE	DT37MG	PC6A
<a href="#">DK4701-ID</a> 1 Way Proximity Access Control Video Kit	DT601/ID-FE	DT47MG	PC6A

\*Please refer to the connectivity part for extension of basic kits.

# V1: SINGLE FAMILY APPLICATION(WIFI KIT)

## DX471 Video KIT



### Monitor:

- 7 inch color TFT screen
- Touch screen operation
- Two wire non polarity connection
- Call transfer via TCP/IP or SIP
- Support max.5 wireless devices
- Picture memory or video memory via SD card
- Compatible with all two wire devices

### Outdoor station

- 170° wide visual angle
- Auto-sensor light illumination
- Unlock and talk indication
- Multi buttons for 1-4 users
- Proximity access control
- IP44 waterproof rate

	Outdoor Option	Monitor Option

Name	Outdoor	Indoor	Power Supply
<a href="#">DX4707</a> 1 Way Wi-Fi Video Intercom Kit	DT607FE/ID	DX471	PC6A
<a href="#">DX4707C</a> 1 Way Wi-Fi Video Intercom Kit	DT607C	DX471	PC6A

\*Please refer to the connectivity part for extension of basic kits.

# A1: APARTMENT SYSTEM, AUDIO



## Solution Features

- Renovation project with old wiring
- Full audio system with economy
- Bus connection anywhere
- One central power supply

## Device Used

- Multi push button door station
- Handset or hand free indoor units
- Power supply unit

## System Capacity

- Max.4 external units
- Max.128 internal units
- No distributor is needed

## Configurations

- Set indoor units' DIP address
- Set door station's address(multi entrance)

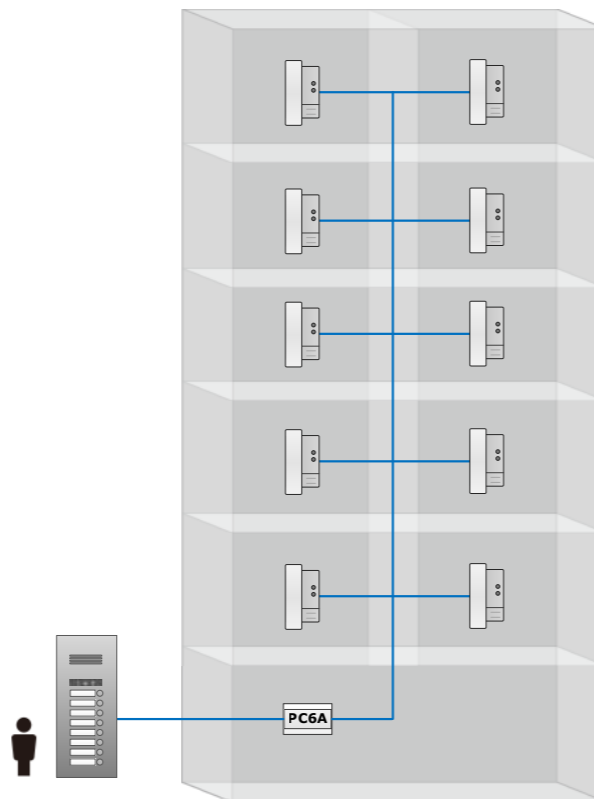

# V2: APARTMENT SYSTEM(STANDARD), VIDEO



## Solution Features

- Low and middle rise small apartment
- Perfect for renovations and refurbishment projects by using existing cables
- Upgrading audio system into video system

## Device Used

- Push button door stations;
- Several indoor units(Video or audio)
- Branch distributor for star topology
- Power supply unit

## System Capacity

- Max.4 external units
- Max.32 internal units
- Max.8 CCTV camera
- Video and Audio units can be mixed

## Configurations

- Set monitors' address(by code or by DIP)
- Set video impedance on farthest distributor
- Set door station's address(multi entrance)

## System Diagram

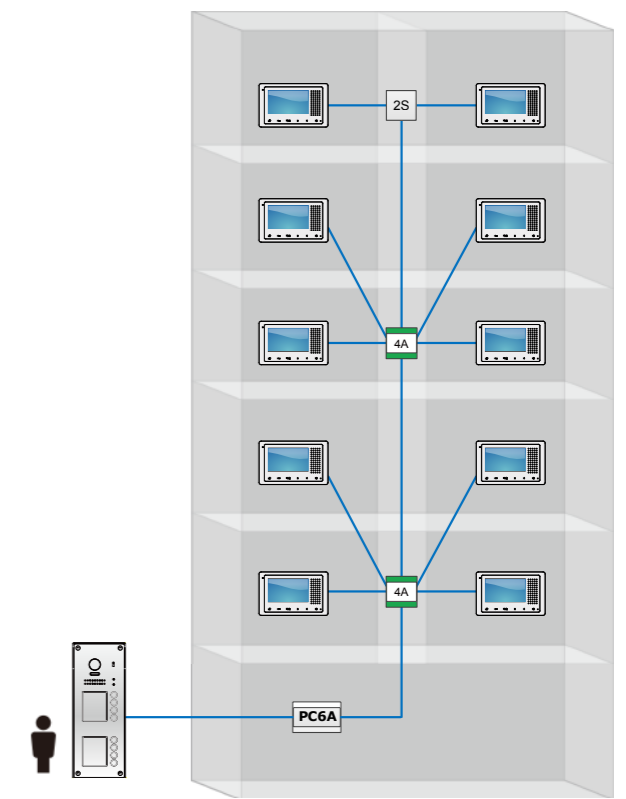

# N1: HIGH RISE BUILDING SYSTEM, VIDEO

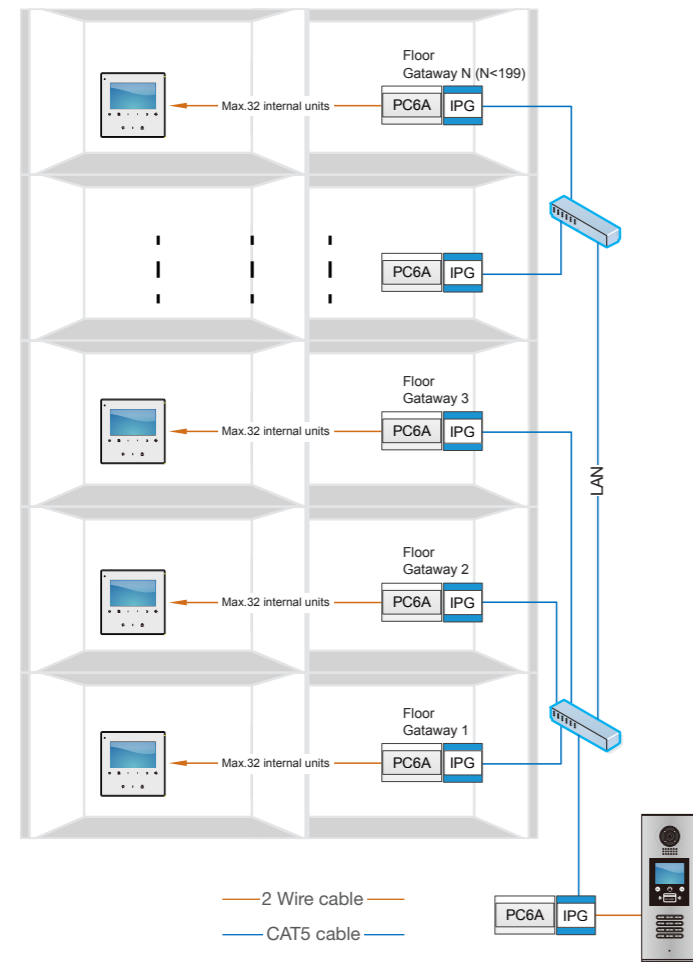

## Solution Features

- Extendable module design suitable for high rise building
- 2-Wire non polarity/center power in each branch line
- Easy wiring according to electric well
- General Ethernet connection among DT-IPGs

## Device Used

- DT-IPG IP gateway
- DMR18S door stations

## Configurations

- DT-IPGs/Monitors' addressing via DIP switch
- Advanced setting by PC software DX-Builder

## System Capacity

- Max.4 external units
- Max 32 internal units per DT-IPG
- Max.199 DT-IPGs
- Floor door station is feasible (same application with N2 diagram)
- Guard station IP-G24 optional.

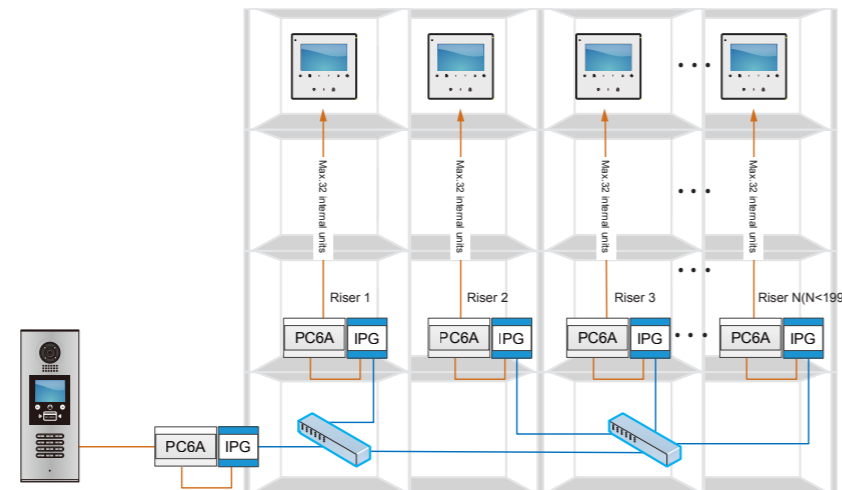

# N2: IP NETWORK APARTMENT FOR COMPLEX, VIDEO

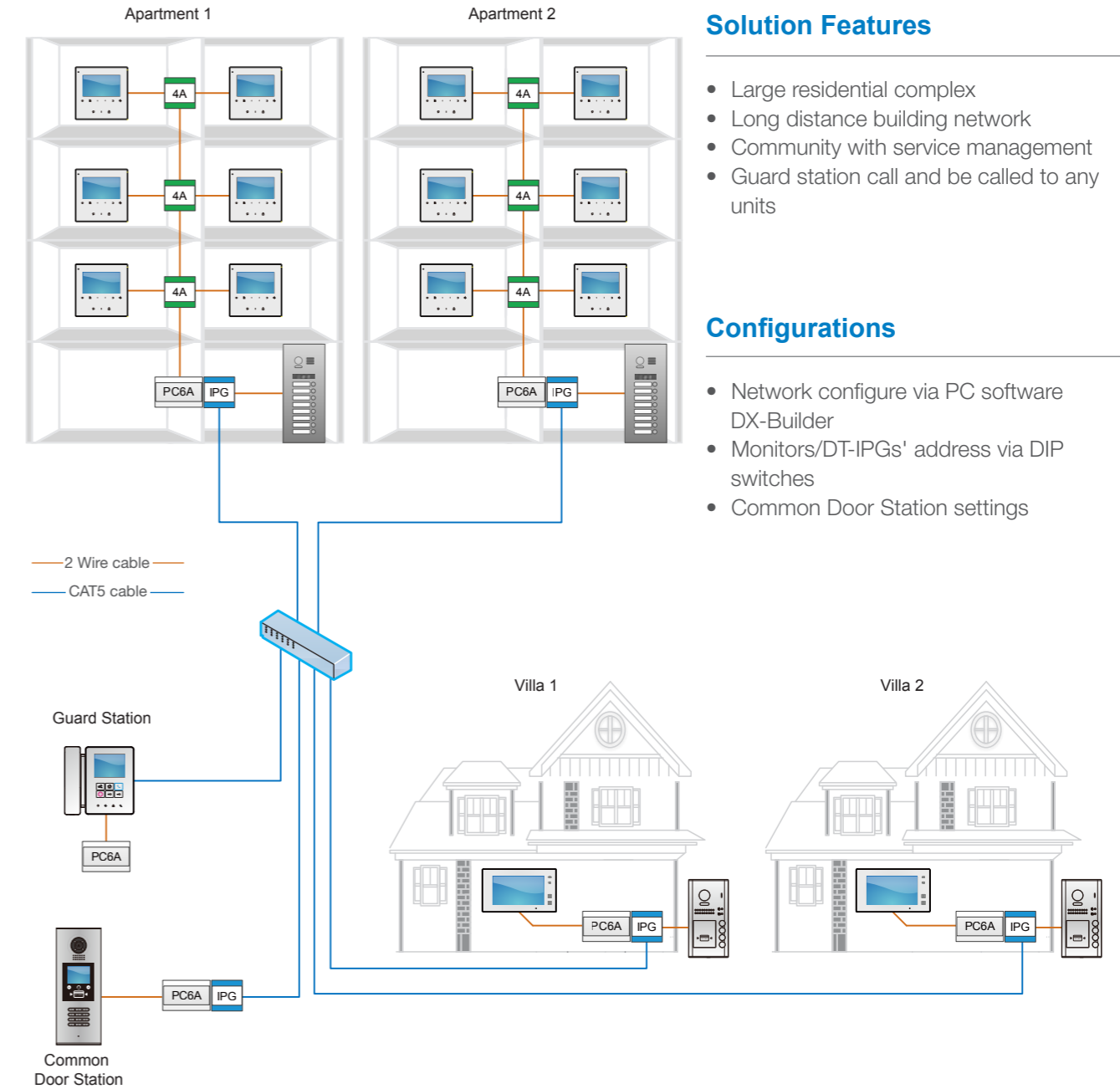

## Solution Features

- Large residential complex
- Long distance building network
- Community with service management
- Guard station call and be called to any units

## Configurations

- Network configure via PC software DX-Builder
- Monitors/DT-IPGs' address via DIP switches
- Common Door Station settings

## System Capacity

- Max.32 Common door stations
- Max.3 Building door stations(or extend by DT-IPG)
- Max.32 Guard stations
- Max.199 DT-IPGs

## Device Used

- DT-IPG IP gateway
- DMR18S Common Door Station
- Guard station IP-G24 for central-service management
- General door stations for Sub-system

# NETWORK DEVICES FOR 2-WIRE IP HYBRID SYSTEM

FUNCTIONAL FEATURES

**DT-IPG Gateway Converter**



- 4 Din-rail design
- Working state indication
- Convenient DIP & button setting

**IP-G24 Guard Station**



- 4.3" touch TFT screen
- Power switch design
- Handset and Hand free mode
- Desk bracket is optional(DB1)

**DX-Builder Configuration Software**



- DX-Builder PC software
- System device management
- Network address assignment

## Description

**DT-IPG**  
 Converting 2-Wire analog signal into Ethernet signal, used as system router or IP network converter

**IP-G24**  
 Guard station terminal with full IP technology, used for switchboard and service management

**DX-builder**  
 Project configuration software for complex system commissions and project maintain management

## Easy wiring

**Plug and play connection**  
 - 2wire non-polarity and RJ45 port Centre power by busline  
 - No additional power supply

**One-cable connection**  
 - POE (RJ45) connection\*

**LAN connection**  
 - Anywhere through same LAN connection

## Quick addressing

**DIP setting**  
 - Quick configuration for simple projects or testing projects

**Code setting**  
 - Addressing by inputting setting codes

**DX builder for online setting**  
 -Centralized configuring by PC or notebook for dozens of IPGs

## Convenient maintain

**Debug and quick-check**  
 -By glancing 4 indicators' combination

**Online FW updating**  
 - Remote updating by network connection  
 -Local updating via USB port

**Online maintenance**  
 -Online devices detection  
 -Online name list updating

## Other functions

-Memory recording  
 -Call transfer  
 -Refer to next page

-Interaction with devices  
 -Multi calling ways & Fuzzy search  
 -Events management  
 -Day/Night calling transfer  
 -Missed call indication

-Video resources management  
 -Calling code setting at will

# SPECIAL SCENARIO APPLICATIONS VIA MODULES

FUNCTIONAL FEATURES

## Camera view from guard station

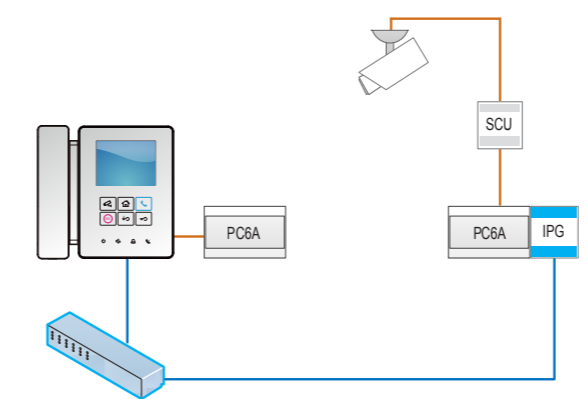

- Video identification with guard center as well as visitor
- Outgoing call with video display from guard station
- SCU camera interface and IPG converter are needed
- DX-builder configuration for video source

## Upgraded IPG(V2) with memory and call divert function



**One module for whole project**  
 -Can be installed at anywhere of bus line

**Used as common memory module**  
 -Video stored by room calling  
 -Retrieve related memory at monitor side

**Used as call transfer module**  
 -Pulic WAN network and personal SIP account are needed  
 -Wired connection with WAN network

## HIGHLIGHTS: System amplifier DT-BDU



### BDU Bus amplifier for 2-Wire system

- Boots the video and audio signal for special occasions
- Max 140M from door station to BDU
- Max 140M from monitor to BDU
- \*RW UTP 2X1.00mm Cable

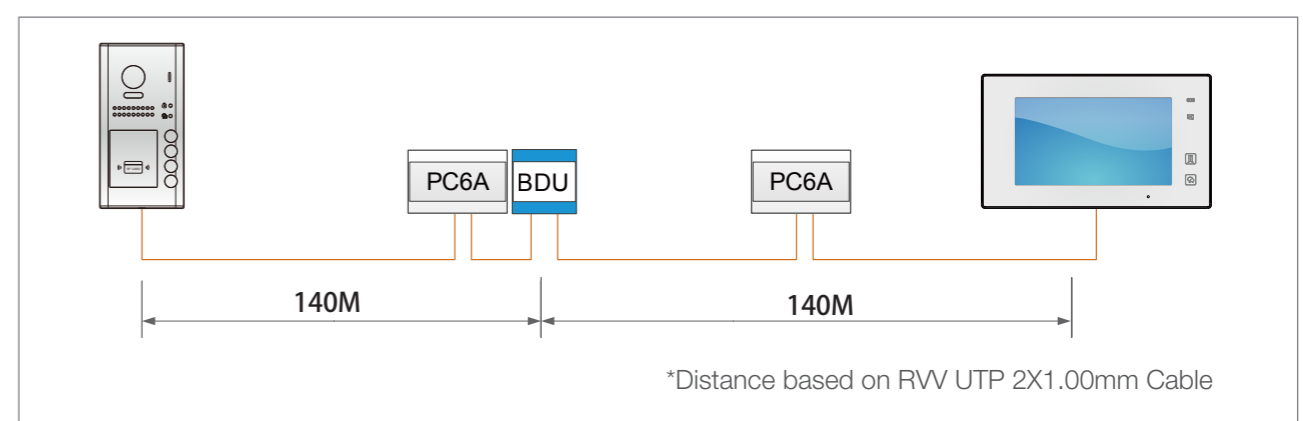

# FISHEYE CAMERA

The door stations support specific 170° wide angle fish-eye camera.

With the fish-eye camera, it allows to identify everyone at the entrance and see individuals up close.

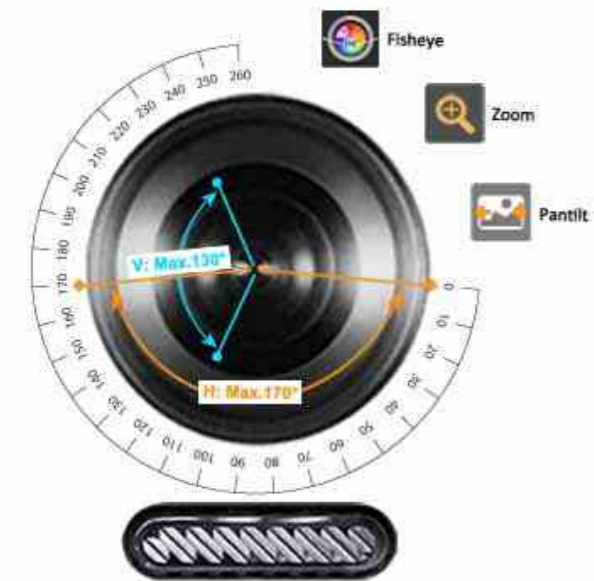

Max. 170° Horizontal View

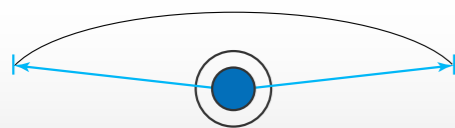

Zoom in/out



Pantilt for auto scanning

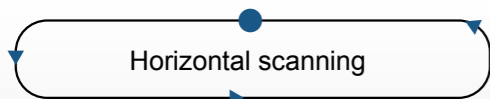

# CAMERA INTERFACE

## Analogue CCTV surveillance



## Camera switch during calling or conversation



## Image quad splitter via DT-QSW



# COMMUNICATION

## Intercom between neighbours

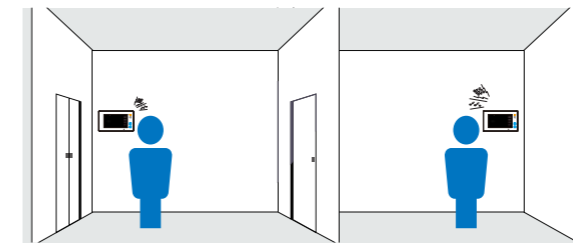

## Inner call & Broadcast among family members

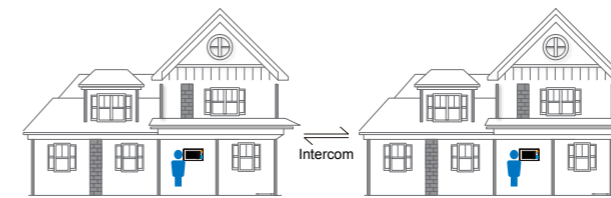

## Communication among devices

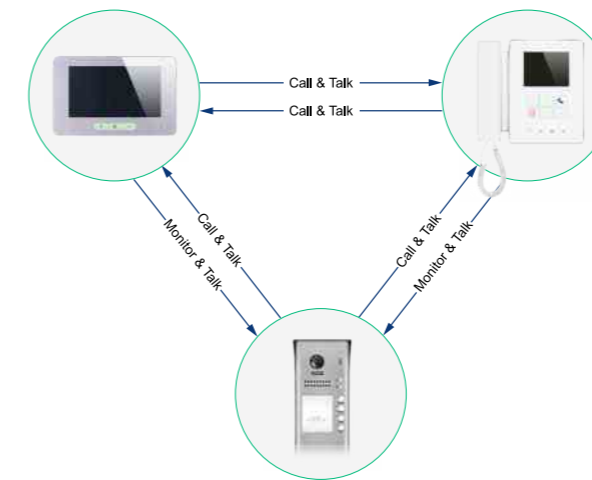

## Message with others(\*)



# RELAY ACTUATOR

## DT-RLC controller module



## DT-ACC converter



# KEYPAD ACCESS PANEL



- Scramble keypad for safety access control
- Zinc alloy housing
- Embedded proximity access control
- IP55 waterproof on wall mounting
- Bus connection with 2 wire bus line
- Stand alone working

# DIAGRAM AND DISTANCE IN VILLA APPLICATION

## Connection Diagram

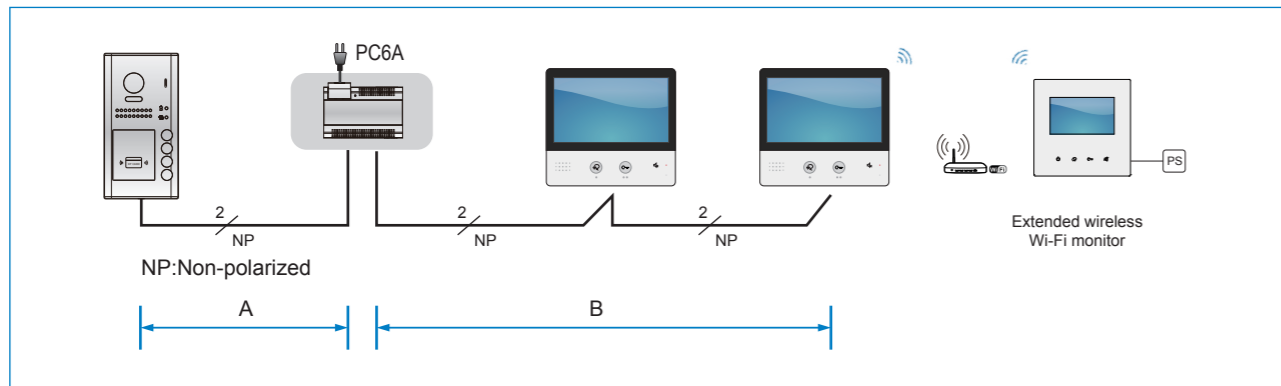

## Cable and Distance

Cable	A(m)	B(m) ≤ 2 IM*	B(m) ≤ 16 IM*
CAT5 Cable (Combined)	40	80	—
Pair Cable (Parallel) 2X0.75 mm <sup>2</sup>	30	50	—
Twisted Cable 2X0.75 mm <sup>2</sup>	60	100	40
Twisted Cable 2X1.0 mm <sup>2</sup>	80	120	60

\*IM means Indoor monitor.

Bus amplifier could extend the distance or strengthen signals while cable is too thin, refer to DT-BDU Page 27

## Extending Monitors(up to 16)

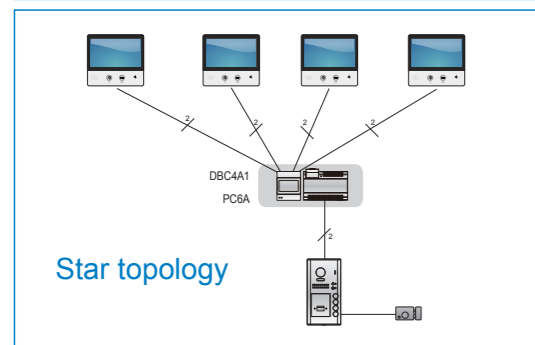
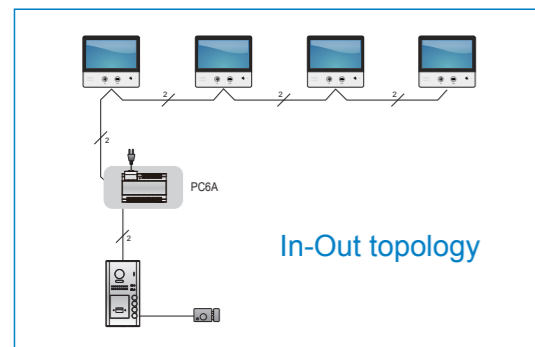

## Extending Door/CCTV Cameras

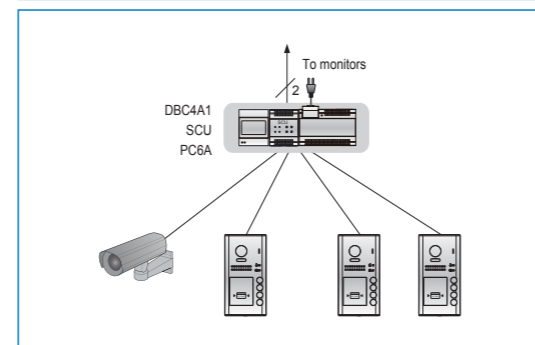
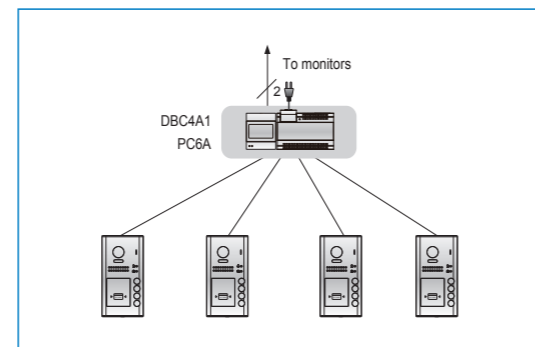

# DIAGRAM AND DISTANCE IN APARTMENT APPLICATION

## Connection Diagram

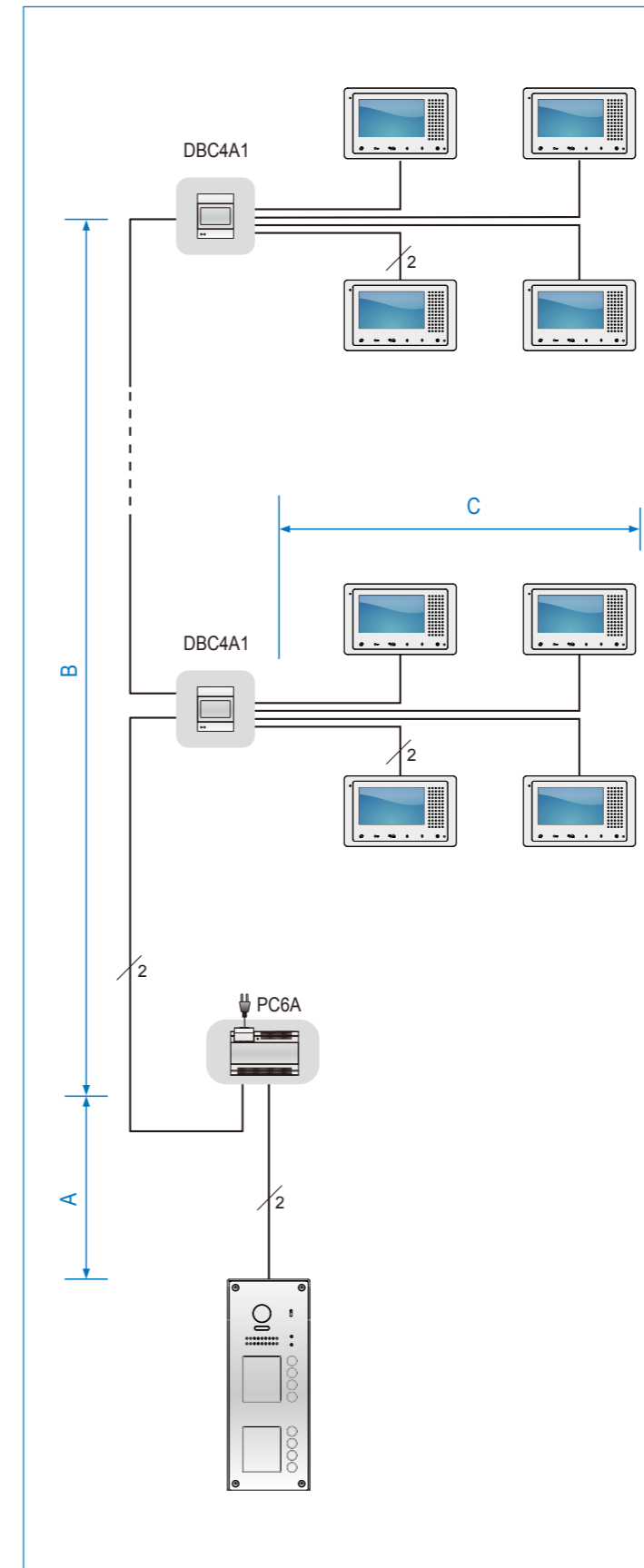

## Cable and Distance

The maximum distance of the wiring is limited in the DT system. Using different cables may also effect the maximum distance of the system can reach.

### When Monitor Quantity < 20

Cable Usage	A	B	C
Twisted cable 2x0.75mm <sup>2</sup>	60	60	30
Twisted cable 2x1 mm <sup>2</sup>	80	80	40











### When Monitor Quantity ≥ 20

Cable Usage	A	B	C
Twisted cable 2x1 mm <sup>2</sup>	70	30	20
Twisted cable 2x1.5 mm <sup>2</sup>	70	50	30

Cables should be non-shielded! And the twisted cables are recommended, if non-twisted cable is used, the total distance will remain only to half.











# PRODUCT LIST FOR INDOOR STATIONS

Model Features	DX471	DT47MG	DT37MG	DT17	DX439	DT43	DT433	DT243	DJ4A	DJ7A
										
Audio									•	•
Color video	•	•	•	•	•	•	•	•		
Surface mounted	•	•	•	•	•	•	•	•	•	•
TFT size	7 inch	7 inch	7 inch	7 inch	4.3 inch	4.3 inch	4.3 inch	4.3 inch		
Touch screen	•	•	•		•					
Mechanical button									•	•
Touch sensor	•	•	•	•	•	•	•	•		
Wi-Fi embeded	•				•					
Wireless extension	•				•					
Call divert	•	•/	•/	•/	•	•/	•/	•/		
Inner memory	•	•	•		•					
Memory via IPG				•*		•	•	•		
View scanning	•	•	•							
Light control	•	•	•		•	•	•	•		
Anti-disturb	•	•	•	•*	•*	•		•		
Message & SMS		•	•							
Intercom	•	•	•	•	•	•	•	•		
Inner intercom	•	•	•	•	•	•	•	•	•	•*
Broadcast		•	•							
Call guard unit	•	•	•	•*	•	•	•	•	•*	
Door bell	•	•	•	•	•	•		•	•	•
Ringer	•	•	•	•	•	•		•		
Multi-Languages	•	•	•	•*	•	•	•*	•		

\* means customized, / means functional modules or gadjes are needed.

# PRODUCT LIST FOR OUTDOOR STATIONS

Model	DT601KP	DT601ID	DT603S	DT607	DT608	DMR21	DMR18S	DMR50
Features								
Audio				•		•/		
Color Video	•	•	•	•	•	•	•	•
Surface mounted	•	•		•	•		•	•
Flush mounted	•	•	•	•*		•	•	
Push button call	•	•	•	•	•	•		
Keypad call						•/	•	•
Extended Panel					•	•		
105° camera			•*	•*	•*		•	
Fisheye max.170° camera	•	•	•	•	•	•		•
Pan view	•	•	•*	•*	•*	•*		•*
Night view	•	•	•	•	•	•	•	•
Zoom in/out	•	•	•	•	•	•		•
Touch key						•/		•/
Voice synthesis						•	•	•
TFT display						•/	•	•
Keypad unlock	•				•*	•/	•	•
RFID unlock		•		•	•	•/	•	•
FW update via SD					•	•	•	•
Rainy cover	•	•		•	•		•	•
IP Rate	IP44	IP44	IP44	IP44	IP44	IP43	IP43	IP44
Panel materials	SSS-304	SSS-304	SSS-304	Zinc alloy	SSS-304	SSS-304	Aluminum	SSS-304
Max. nos of calls	1	1	2	4	32	128/	6368	6368

\* means customized, / means functional modules or gages are needed.

# PRODUCT LIST FOR ACCESSORIES



**DT-AKP Scrambled Access Keypad Panel**  
 Zinc alloy, scramble keys, proximity access, IP55 rate  
 Dimension:151(L)x95(W)x37(H)mm(with rainy cover)  
 145(L)x90(W)x23(H)mm(without rainy cover)



**DJ7A Audio Phone**  
 Aluminum front panel, handfree, door bell connection  
 Dimension:138(L)x90(W)x18(H)mm



**DJ4A Handset Audio Phone**  
 Aluminum front panel, door bell connection  
 Dimension:187(L)x97(W)x33(H)mm



**PS5 Power supply +DPS power separator**  
 PS5 Power supply,24V with 4.5A DC outputs  
 DPS power separator used with PS5



**PC6A Power combo**  
 Power supply unit, 26V with outputs DC 1.5A outputs  
 6 Din rail



**PC4 Power combo**  
 Power supply unit, 24V with DC 0.75A outputs, used for villa kit or local power supply  
 4 Din rail

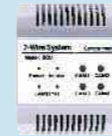

**DT-SCU Camera Control Unit**  
 Max.2 inputs analogue cameras

**DT-QSW Quad Camera Switcher**  
 Max.4 inputs analogue cameras, image quad

**DT-BDU Bus Amplifier**  
 Bus signal repeater, used with PC6A

**DT-IPG IP Gateway**  
 IP converter, network devices, public memory, call transfer



**DBC4A1 Video Distributor**  
 4 channels distributor, star topology for multi door stations or indoor monitors

**DT-RLC Relay Actuator**  
 Used for light control or 2nd lock control



**DBC2S Video Distributor**  
 2 channels distributor, star topology for multi door stations or indoor monitors

**DT-CCU Camera Interface Unit**

**DT-ACC-S Weigand Converter**  
 DIP addressing, max.4



**DB1 Desk top bracket**  
 DB1-W white version DB1-B black version, for monitor use(except DT37, DT433)

# APPENDIX.DIMENSIONS(unit:mm)

DX439

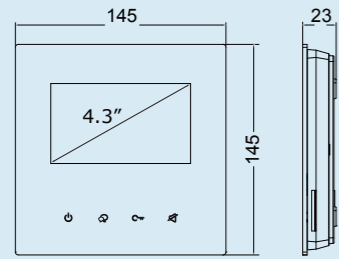

DX471

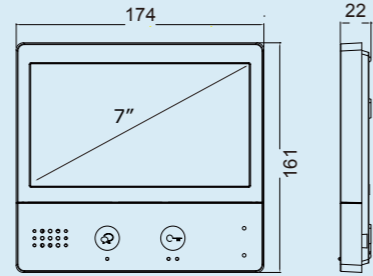

DT433

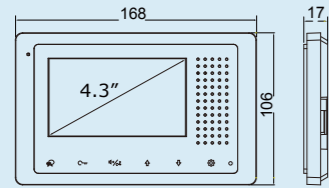

DT37MG

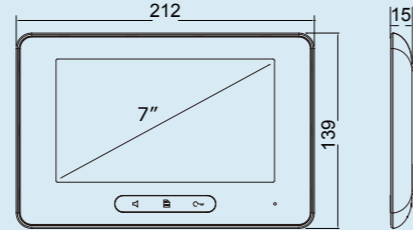

DT43

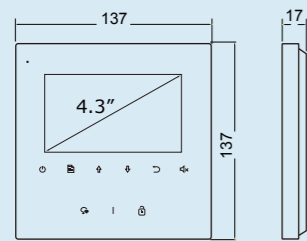

DT47MG

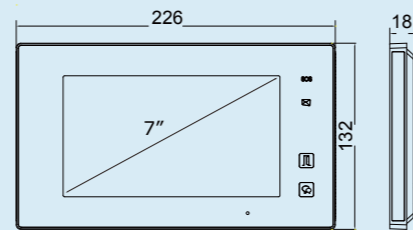

IP-G24/ DT243

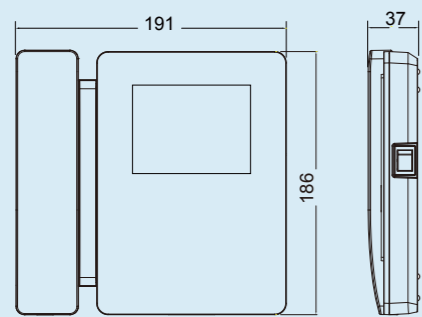

DT17

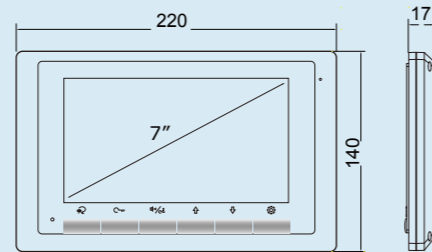

DT601 Surface

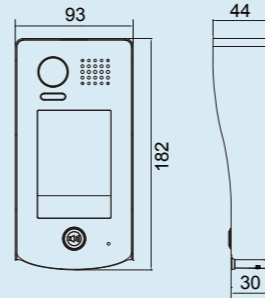

DT601 Flush

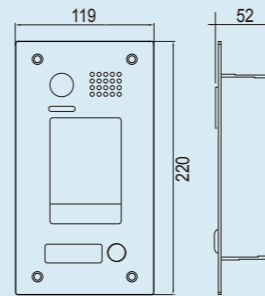

DT607 Surface

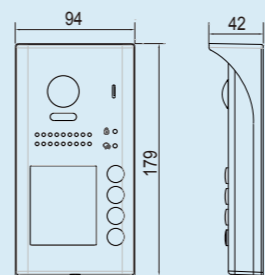

DT607 Flush

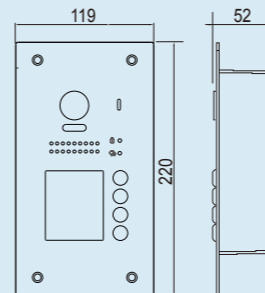

DT608

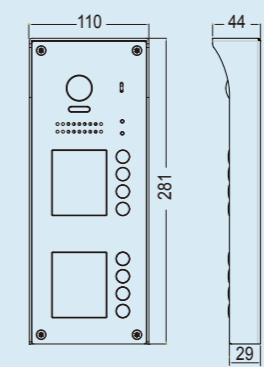

DMR21

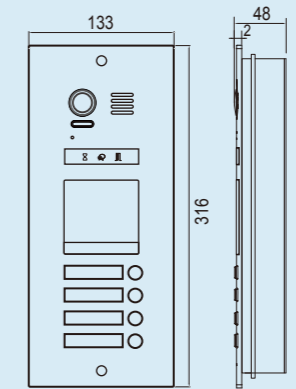

DT-AKP

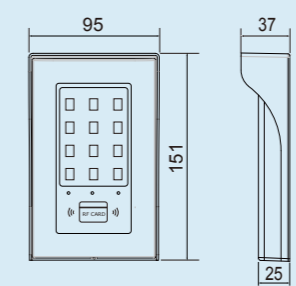

DMR50

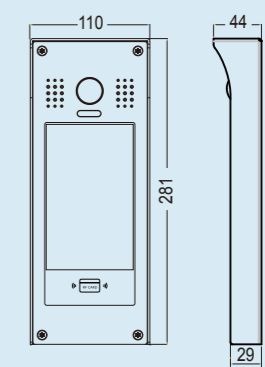

DMR18S

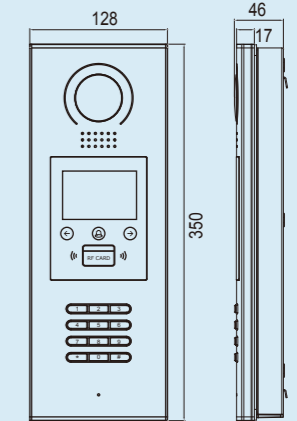

DT603S

