

E145S

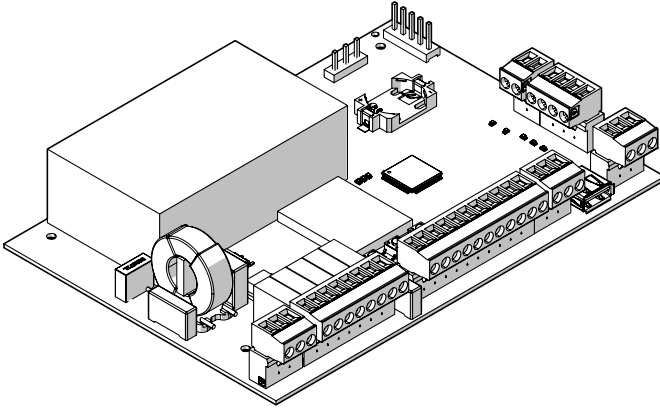

FAAC



FAAC S.p.A. Soc. Unipersonale
Via Calari, 10 - 40069 Zola Predosa BOLOGNA - ITALY
Tel. +39 051 61724 - Fax +39 051 09 57 820
www.faac.it - www.faacgroup.com

© Copyright FAAC S.p.A. dal 2020. Tutti i diritti riservati.

Nessuna parte di questo manuale può essere riprodotta, archiviata, distribuita a terzi né altrimenti copiata, in qualsiasi formato e con qualsiasi mezzo, sia esso elettronico, meccanico o tramite fotocopia, senza il preventivo consenso scritto di FAAC S.p.A.

Tutti i nomi e i marchi citati sono di proprietà dei rispettivi fabbricanti.

I clienti possono effettuare copie per esclusivo utilizzo proprio.

Questo manuale è stato pubblicato nel 2020.

© Copyright FAAC S.p.A. from 2020. All rights reserved.

No part of this manual may be reproduced, archived, distributed to third parties nor copied in any other way, in any format and with any means, be it electronic, mechanical or by photocopying, without prior written authorisation by FAAC S.p.A.

All names and trademarks mentioned are the property of their respective manufacturers.

Customers may make copies exclusively for their own use.

This manual was published in 2020.

© Copyright FAAC S.p.A. depuis 2020. Tous droits réservés.

Aucune partie de ce manuel ne peut être reproduite, archivée ou distribuée à des tiers ni copiée, sous tout format et avec tout moyen, qu'il soit électronique, mécanique ou par photocopie, sans le consentement écrit préalable de FAAC S.p.A.

Tous les noms et les marques cités sont la propriété de leurs fabricants respectifs.

Les clients peuvent faire des copies pour leur usage exclusif.

Ce manuel a été publié en 2020.

© Copyright FAAC S.p.A. ab dem 2020. Alle Rechte vorbehalten.

Kein Teil dieses Handbuchs darf reproduziert, gespeichert, an Dritte weitergegeben oder sonst auf eine beliebige Art in einem beliebigen Format und mit beliebigen Mitteln kopiert werden, weder mit elektronischen, noch mechanischen oder durch Fotokopieren, ohne die Genehmigung von FAAC S.p.A.

Alle erwähnten Namen und Marken sind Eigentum der jeweiligen Hersteller. Die Kunden dürfen nur für den Eigengebrauch Kopien anfertigen.

Dieses Handbuch wurde 2020 veröffentlicht.

© Copyright FAAC S.p.A. del 2020. Todos los derechos están reservados.

No puede reproducirse, archivar, distribuirse a terceros ni copiarse de ningún modo, ninguna parte de este manual, con medios mecánicos o mediante fotocopia, sin el permiso previo por escrito de FAAC S.p.A.

Todos los nombres y las marcas citadas son de propiedad de los respectivos fabricantes.

Los clientes pueden realizar copias para su uso exclusivo.

Este manual se ha publicado en 2020.

© Copyright FAAC S.p.A. van 2020. Alle rechten voorbehouden.

Niets uit deze handleiding mag gereproduceerd, gearchiveerd, aan derden openbaar gemaakt of op andere wijze gekopieerd worden, in om het even welke vorm en met geen enkel middel, noch elektronisch, mechanisch of via fotokopiëren, zonder schriftelijke toestemming vooraf van FAAC S.p.A.

Alle vermelde namen en merken zijn eigendom van de respectievelijke fabrikanten.

De klanten mogen kopieën maken die enkel voor eigen gebruik bestemd zijn.

Dez handleiding werd in 2020 gepubliceerd.

CONTENTS

EU Declaration of conformity 2

1. INTRODUCTION TO THIS INSTRUCTION MANUAL 2

 Meaning of the symbols used 3

2. SAFETY RECOMMENDATIONS 4

 2.1 Installer safety 4

 2.2 Storage 4

 2.3 Waste disposal 4

3. E145S 5

 3.1 Intended use 5

 3.2 Limitations of use 5

 3.3 Unauthorised use 5

 3.4 Product identification 5

 3.5 Technical specifications 6

4. INSTALLATION REQUIREMENTS 7

 4.1 Electrical system 7

5. INSTALLATION 7

 5.1 Tools required 7

 5.2 Components 8

 5.3 Connections 9

 Control devices 9

 Limit switches 10

 BUS 2easy devices 10

 Outputs 10

 Electric locks 11

 Radio receiver/decoder board 11

 XF radio module 11

 Flashing light 11

 Motors 12

 Mains power supply 12

6. SET-UP 13

 6.1 Turn power on to the board 13

 6.2 Programming 13

 6.3 Operating logics 17

 6.4 Setup 19

 6.5 Configuring movements and timing 20

 6.6 Adjusting the anti-crushing system 20

7. PUTTING INTO SERVICE 20

 7.1 Final checks 20

 7.2 Close the enclosure 20

 7.3 Final operations 20

8. ACCESSORIES 21

 8.1 Relay photocells 21

 8.2 Sensitive edges 22

 8.3 Limit switches 22

 8.4 BUS 2easy devices 23

 Connection 23

 BUS 2easy photocells 23

 BUS 2easy encoder 24

 BUS 2easy control devices 25

 BUS 2easy status 25

 BUS 2easy device registration 25

 Checking the BUS 2easy devices 26

 8.5 XF radio module 26

 Radio controls SLH/SLH LR 26

 Radio controls - RC/LC 27

 Radio controls - DS 27

 Deleting radio controls 27

 8.6 Simply Connect 28

9. UPLOAD/DOWNLOAD 29

 Upload Operations 29

 Download Operations 29

10. DIAGNOSTICS 30

 10.1 Firmware version 30

 10.2 Checking the movement 30

 10.3 Automated system status 30

 10.4 LEDs check 30

 10.5 Error codes, Alarms, Info 31

11. MAINTENANCE 33

 11.1 Routine maintenance 33

 11.2 Cycle counter 34

 11.3 Maintenance requested 34

 11.4 Buffer battery 34

TABLES

 1 Technical data E145S 6

 2 BASIC programming menu 14

 3 ADVANCED programming menu 15

 4 SETUP phases 19

 5 Assigning an address to the Photocells 23

 6 Addressing Sensitive Edges 24

 7 Addressing Control Devices 25

 8 Automated system status 30

 9 Status of the LEDs 30

 10 Errors, Alarms, Info 31

 11 Scheduled maintenance 33

EU DECLARATION OF CONFORMITY

The Manufacturer

Company name: FAAC S.p.A. Soc. Unipersonale

Address: Via Calari, 10 - 40069 Zola Predosa BOLOGNA - ITALY

hereby declares under its own exclusive liability that the following product:

Description: electronic equipment

Model: E145S

complies with the following applicable EU legislations:

2014/30/EU

2014/35/EU

2011/65/UE

Furthermore, the following harmonised standards have been applied:

EN 61000-6-2:2005

EN 61000-6-3:2007+A1:2011

EN 60335-1:2012+A11:2014+A13:2017

Other standards applied:

EN 13849-1:2015 CAT.2 PL "C"

EN 13849-2:2012

EN 60335-2-103:2015

Bologna, 01-08-2020

CEO
A. Marcellan



1. INTRODUCTION TO THIS INSTRUCTION MANUAL

This manual provides the correct procedures and requirements for installing E145S and maintaining it in a safe condition.

When drafting the manual, the results of the risk assessment conducted by FAAC S.p.A. on the entire product life cycle have been taken into account in order to implement effective risk reduction measures. The following stages of the life cycle of the product have been considered:

- Delivery/handling
- Assembly and installation
- Set-up and commissioning
- Operation
- Maintenance/troubleshooting
- Disposal at the end of the product's life cycle

Risks arising from installation and using the product have been taken into consideration; these include:

- Risks for the installation/maintenance technician (technical personnel)
- Risks for the user of the automation system
- Risks to product integrity (damage)

In Europe, the automation of a gate falls under the Machinery Directive 2006/42/EC and the corresponding harmonised standards. Anyone automating a gate (new or existing) is classified as the Manufacturer of the Machine. They are therefore required by law, among other things, to carry out a risk analysis of the machine (automatic gate in its entirety) and take protective measures to fulfil the essential safety requirements specified in Annex I of the Machinery Directive.

FAAC S.p.A. recommends that you always comply with the EN 12453 standard and in particular that you adopt the safety criteria and devices indicated, without exception, including the dead-man function.

This manual also contains general information and guidelines, which are purely illustrative and not exhaustive, in order to facilitate the activities carried out by the Manufacturer of the Machine in all respects with regard to carrying out the risk analysis and drafting the instructions for use and maintenance of the machine. It should be clearly understood that FAAC S.p.A. accepts no liability for the reliability and/ or completeness of the above instructions. As such, the manufacturer of the machine must carry out all the activities required by the Machinery Directive and the corresponding harmonised standards on the basis of the actual condition of the locations and structures where the product E145S will be installed, prior to commissioning the machine. These activities include the analysis of all the risks associated with the machine and subsequent implementation of all safety measures intended to fulfil the essential safety requirements.

This manual contains references to European standards. The automation of a gate must fully comply with any laws, standards and regulations applicable in the country where installation will take place.

 Unless otherwise specified, the measurements provided in the instructions are in mm.

MEANING OF THE SYMBOLS USED



NOTES AND WARNINGS IN THE INSTRUCTIONS

 **WARNING ELECTRIC SHOCK HAZARD** - The procedure or step described must be carried out following the instructions provided and according to the applicable safety regulations

 **WARNING, PERSONAL INJURY HAZARD OR RISK OF DAMAGE TO COMPONENTS** - The procedure or step described must be carried out following the instructions provided and according to the applicable safety regulations.

 **WARNING** - Details and specifications that must be complied with in order to ensure that the system operates correctly.

 **RECYCLING AND DISPOSAL** - The materials used in manufacturing, the batteries and any electronic components must not be sent to landfill. They must be taken to authorised recycling and disposal centres

 **FIGURE** E.g.:  1-3 see Figure 1 - detail 3.

 **TABLE** E.g.:  1 see Table 1.

§ **CHAPTER/SECTION** E.g.: §1.1 see section 1.1.

○ **LED off**

● **LED on**

* **LED flashing**

* **LED flashing quickly**

PERSONAL PROTECTIVE EQUIPMENT

Personal protective equipment must be worn to protect against hazards (e.g. crushing, cutting, shearing etc.):

 **Obligation to wear work gloves**

 **Obligation to wear safety footwear**

SAFETY INSTRUCTIONS

 **GENERIC HAZARD**
Personal injury hazard or risk of damage to components

 **ELECTROCUTION HAZARD**
Risk of electric shock from live parts

 **BURNING OR SCALDING HAZARD**
Risk of burns or scalding due to the presence of high-temperature parts

 **RISK OF CUTTING/AMPUTATION/PUNCTURE** - Cutting hazard due to the presence of sharp components or the use of pointed/sharp tools

 **RISK OF TRAPPING HANDS** - Risk of trapping hands due to moving parts

 **RISK OF SHEARING** - Risk of shearing due to moving parts

 **RISK OF IMPACT/CRUSHING/SHEARING** - Risk of impact, crushing or shearing due to moving parts

2. SAFETY RECOMMENDATIONS

This product has been placed on the market as a control system for one or two gate operators and therefore must not be put into service until the machine into which it has been incorporated has been declared compliant with the Machinery Directive 2006/42/EC by its manufacturer.



Incorrect installation and/or incorrect use of the product might cause serious harm to people. Read the instructions before using the product and comply with them. Keep these instructions for future reference. Perform installation and other activities adhering to the sequences provided in the instructions manual. Always comply with all the requirements contained in the instructions and warning tables at the beginning of the paragraphs. Always comply with the safety recommendations.

Only the installer and/or maintenance technician is/are authorised to carry out work on the components of the automation. Do not make any modifications to the original components.

Cordon off the work site (even temporarily) and prohibit access/transit. For EC countries, comply with the national legislation that transposes the European Directive on Construction sites 92/57/EC.

The installer is responsible for the installation/testing of the automation and for preparing the system Register.

The installer must demonstrate or declare that he/she has the technical-professional competency to carry out the installation, testing and maintenance in accordance with the requirements of these instructions.

2.1 INSTALLER SAFETY

Installation activities require special work conditions to reduce to the minimum the risks of accidents and serious damage. Furthermore, the suitable precautions must be taken to prevent risks of injury to persons or damage.



The installer must be in good physical and mental condition, aware of and responsible for the hazards that may be generated when using the product. The work area must be kept tidy and must not be left unattended.

Do not wear clothes or accessories (scarves, bracelets, etc.) that may get caught in moving parts.

Always wear the personal protective equipment rec-

ommended for the type of activity to be carried out. The required level of workplace lighting must be equal to at least 200 lux.

Operate CE marked machinery and equipment in compliance with the manufacturer's instructions. Use work instruments in good conditions.

Use the transport and lifting equipment recommended in the instructions manual.

Use safety-compliant portable ladders of adequate size, fitted with anti-slip devices at the top and bottom, equipped with retainer hooks.

2.2 STORAGE

Store the product in its original packaging, in closed and dry premises, protected from the sun and free from dust and aggressive substances. Protect from mechanical stress. If stored for more than 3 months, regularly check the condition of the components and the packaging.

- Storage temperature: 5°C to 30°C.
- Percentage of humidity: 30% to 70%.

2.3 WASTE DISPOSAL



The packaging materials (plastic, polystyrene etc.) must not be left within reach of children as they are potential sources of danger.

Discard the packaging after use in the appropriate containers in compliance with waste disposal regulations.

After having dismantled the product, dispose of it in compliance with the current waste disposal regulations.



Components and structural materials, batteries and electronic components must not be disposed of together with household waste. They must be taken to authorised disposal and recycling centres.

3. E145S

3.1 INTENDED USE

The FAAC E145S electronic board has been designed to control actuators (hydraulic or electromechanical) or gearmotors for motorized gates intended for installation in areas that are accessible to people, the main purpose of which is to provide safe access for goods or vehicles or people in industrial, commercial or residential settings.



Any other use that is not expressly specified in these instructions is prohibited and could affect the integrity of the product and/or represent a source of danger.

3.2 LIMITATIONS OF USE

- The E145S can control one or two 230 V~ operators. Mixed configurations are not allowed with sliding gate gearmotors (e.g. you cannot connect a sliding gate gearmotor with a swing gate operator).
- Using the product in any configuration other than that intended by FAAC S.p.A. is prohibited. It is prohibited to modify any of the product's components

3.3 UNAUTHORISED USE

- Do not use on motors or devices that are intended for purposes other than operating gates.
- Uses other than the intended use are prohibited.
- It is prohibited to install the E145S on smoke and/or fire doors.
- It is prohibited to install the E145S in environments in which there is a risk of explosion and/or fire: the presence of flammable gases or fumes is a serious safety hazard (the product is not ATEX certified).
- It is prohibited to power the system with energy sources other than those specified.
- It is prohibited to integrate commercial systems and/or equipment other than those specified, or use them for purposes not envisaged and authorised by the corresponding manufacturers.
- It is prohibited to use and/or install accessories which have not been specifically authorised by FAAC S.p.A.
- It is prohibited to use the E145S in the presence of faults which could compromise safety.
- Do not allow water jets of any type or size to come into direct contact with the E145S.
- Do not expose the E145S to corrosive chemical or environmental agents.

3.4 PRODUCT IDENTIFICATION

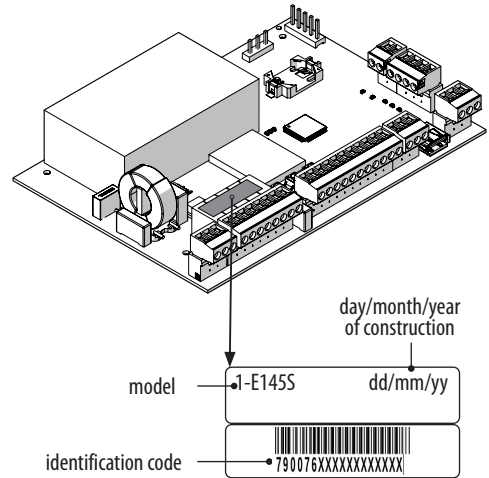

3.5 TECHNICAL SPECIFICATIONS

E145S It is an electronic board designed to control one or two 230 V~ motors with an overall power of 800 W (800 W refers to the sum of the loads connected to the two motor outputs irrespective of how they are distributed).

Switching power supply The switching power supply reduces power consumption in stand-by, keeps the output voltage stable even in the event of fluctuations in the mains supply and works over a wide range of input voltages.

Programming There are two menus for programming from the board, via display and dedicated buttons: BASIC and ADVANCED.

In addition, remote programming from Simply Connect provides a larger number of options, including uploading / downloading the programming and updating the board FW.

Simply Connect This CLOUD platform allows remote communication with the automation, with modes specific for the installer or user. Simply Connect requires an accessory connectivity module to be plugged in, which is chosen according to technology used:

- XMB (GSM for mobile, Bluetooth Low Energy technology)
- XWBL (WiFi, LAN, Bluetooth Low Energy technology)

Bus 2easy It is possible to connect FAAC Bus 2easy devices (photocells, sensitive edges and control devices) to the E145S board.

Radio system The E145S is fitted with an integrated two channel decoding system (Omnidec) that can memorise, various types of Faac radio codes by simply adding a radio module.

In addition, a quick insertion (5 pin) connector for FAAC radio/decoder boards is available.

Sensitive edges The E145S has two inputs for connecting NC or 8.2 K Ω resistive sensitive edges. Up to two 8.2 K Ω resistive sensitive edges can be connected in parallel to each input.

Encoder An accessory encoder can be connected (e.g. SAFEncoder BUS 2easy) or integrated in the operator (e.g. S800 ENC). The electronic board detects the angular position and the speed of movement of the leaf via the encoder and is able to detect the presence of an obstacle.

Limit switches The E145S has inputs for opening and closing limit switches that can be used to start the slowdown or stop the gate.

End of travel slowdown The E145S can slow down the movement close to the open and closed positions, in order to limit inertial forces and reduce the vibrations of the gate when it is stopping.

1 Technical data E145S

Power supply voltage	90...260 V~ 50/60 Hz
Max power	stand-by: 4 W sleep: <2 W
Max. motor power	800 W total
Max. accessories load	24 V=== 500 mA Bus 2easy 500 mA
Max. flashing light load	230 V~ 60 W max
Ambient operating temperature	-20...+55 °C

4. INSTALLATION REQUIREMENTS

4.1 ELECTRICAL SYSTEM



Always shut off the power supply before performing any work. If the disconnect switch is not in view, apply a warning sign stating "WARNING - Maintenance in Progress".



The electrical system must comply with applicable legislation in the country of installation.

Use components and materials with CE marking which are compliant with the Low Voltage Directive 2014/35/EU and EMC Directive 2014/30/EU.

The power supply line for the automation must be fitted with a multi-pole circuit breaker, with a suitable tripping threshold, a contact opening distance of at least 3 mm and a breaking capacity that complies with current regulations.

The power supply for the automation must be fitted with a 30 mA differential switch.

The metal parts of the structure must be earthed.

Check that the protective earthing system complies with applicable regulations in the country of installation.

The electrical cables of the automation system must be of a size and insulation class that is compliant with current legislation and laid in appropriate rigid or flexible conduits, either above or below ground.

Use separate conduits for the power supply and the 12-24 V control devices / accessories cables.

Check buried cable plans to ensure that there are no other electrical cables in proximity to the planned digging/drilling locations to prevent the risk of electrocution.

Check that there are no pipes in the vicinity as well.

The external electronic board must be housed in an enclosure that has a minimum IP 44 protection rating and fitted with a lock or another type of device to prevent access by unauthorised persons. The enclosure must be located in an accessible and non-hazardous area and at least 30 cm from the ground. The cable outlets must face downwards.

The conduit fittings and the cable glands must prevent the entry of moisture, insects and small animals.

Protect extension connections using junction boxes with an IP 67 protection rating or higher.

The overall length of the BUS cables must not exceed 100 m.

It is recommended to install a flashing light in a visible position to indicate when it is moving.

The control accessories must be positioned in areas that are always accessible and not dangerous for the user. It is recommended to position the control accessories within the field of view of the automation. This

is mandatory in the case of hold-to-run controls.

The hold-to-run controls in the dead-man mode of operation, must comply with standard EN 60947-5-1. If an emergency stop button has been installed, it must be EN13850 compliant.

Comply with the following heights from the ground:

- control accessories = minimum 150 cm
- emergency buttons = maximum 120 cm

If the manual controls are intended to be used by disabled or infirm persons, highlight them with suitable pictograms and make sure that these users are able to access them.

5. INSTALLATION

RISKS



PERSONAL PROTECTIVE EQUIPMENT



ALWAYS DISCONNECT THE POWER SUPPLY before working on the board.

If the disconnect switch is not in view, apply a warning sign stating "WARNING - Maintenance in Progress".

Turn the power on only after having made all the electrical connections and carried out the preliminary start-up checks.

5.1 TOOLS REQUIRED



Use appropriate tools and equipment in working environments which comply with applicable legislation.

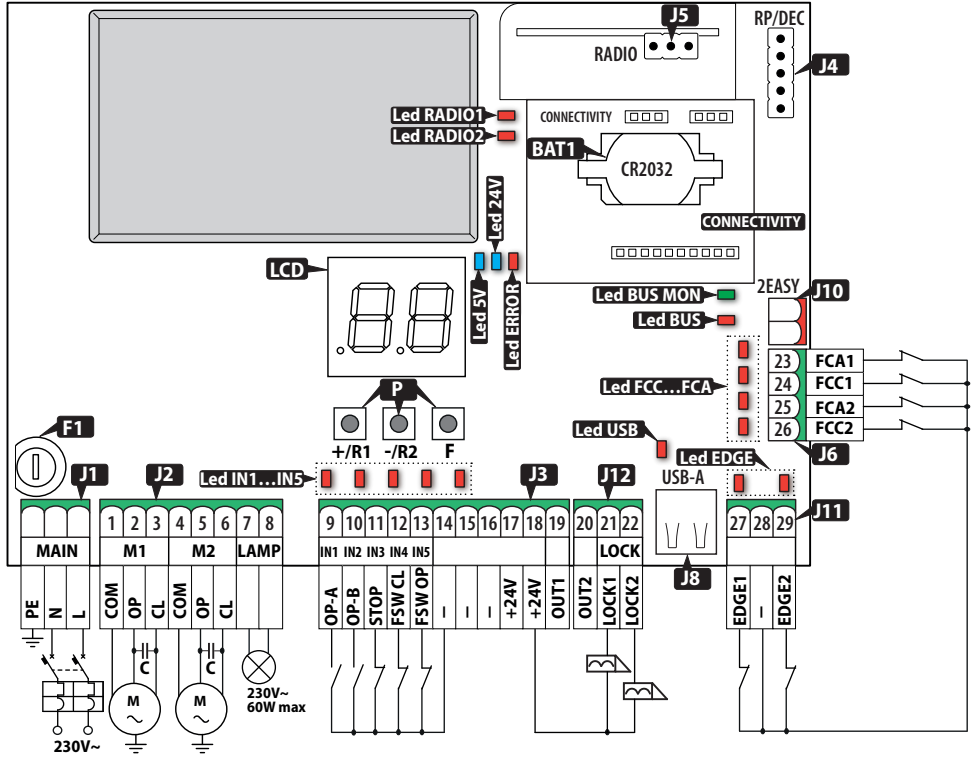

5.2 COMPONENTS

KEY:

- J1 Removable terminal board for the mains power supply
- J2 Removable terminal board for connecting motors and flashing light
- J3 Removable terminal board for connecting control devices, accessories power supply and output (OUT1)
- J4 Connector (5 pin) for FAAC radio/decoder boards
- J5 Connector (3 pin) for FAAC XF radio module
- J6 Removable terminal board for connecting limit switches
- J8 USB-A port
- J10 Removable terminal board for connecting Bus 2easy devices
- J11 Removable terminal board for connecting sensitive edges
- J12 Removable terminal board for connecting electric lock and output (OUT2)
- LCD Programming display
- P Programming buttons

KEY:

- F1 Power supply fuse (F10 A)
- BAT1 Buffer battery holder CR2032
- CONNECTIVITY Connector for Simply Connect board
- Status LEDs :
- IN1...IN5 LEDs Inputs for control devices
- EDGE LEDs Inputs for sensitive edges
- FCC...FCA LEDs Inputs for opening/closing limit switches
- USB LED USB pen drive present
- BUS LED Bus 2easy devices
- BUS MON LED Bus 2easy line
- 5V LED Power supply 5V=
- 24V LED Accessories power supply 24V=
- ERROR LED Error/alarm signalling
- RADIO1 LED Channel 1 Omnidec
- RADIO2 LED Channel 2 Omnidec

5.3 CONNECTIONS

 Carry out the connections with the power supply disconnected.

CONTROL DEVICES

 Multiple NO contacts on same input must be connected in parallel.
 Multiple NC contacts on same input must be connected in series.
 Below is a brief explanation of the inputs. The effect a command has may vary according to the operating logic and programming functions.

■ Connecting the devices to terminal board J3:

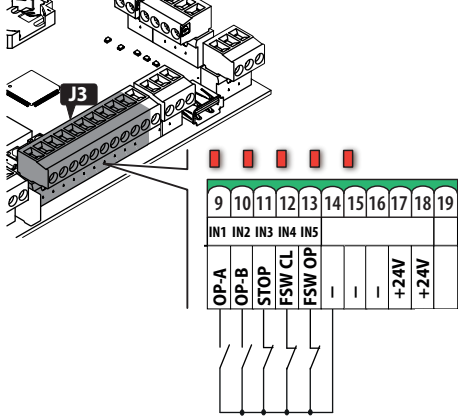

9 OP-A (IN1) (TOTAL motion command)
 NO contact, connect a push-button or another type of pulse generator which, by closing a contact, commands the total opening (OPEN) of the gate.

10 OP-B (IN2) (Motion command determined by the set operating logic)
 NO contact, connect a push-button or another type of pulse generator which, by closing a contact, causes the gate to close (CLOSE in logics c, b, bC) or PARTIAL open (in all other logics):
 The partial opening is:
 • 50% of the complete opening in systems with only one motor
 • complete only for the leaf actuated by motor 1 in two motor systems

11 STOP (IN3) (Stop command)
 NC contact, connect a push-button or another type of pulse generator which, by opening a contact, causes the automation to stop.

12 FSW CL (IN4) (Photocells active during closing)
 NC contact, connect a photocell or another device that, by opening the contact during closing, reverses the gate.

13 FSW OP (IN5) (Photocell active in opening)
 NC contact, connect a photocell or another device that, by opening the contact during opening, reverses the gate.

14...16 - Common contacts / Accessories power supply negative

■ Connecting the devices to terminal board J11:

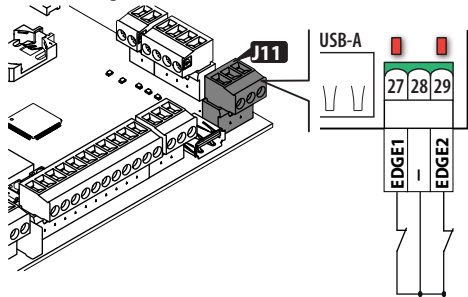

27 EDGE1 (Safety in opening devices active)
 Connect a sensitive edge that, when activated during opening, causes the gate to reverse.
 This input can be configured by setting programming function S_0 to connect:
 • sensitive edges with NC contact - default-
 • resistive sensitive edges 8.2 k Ω

28 - Common contacts / Accessories power supply negative

(Safety in closing devices active)
 Connect a sensitive edge that, when activated during closing, causes the gate to reverse.
 This input can be configured by setting programming function S_{Σ} to connect:

29 EDGE2

- sensitive edges with NC contact -default-
- resistive sensitive edges 8.2 k Ω

i If the input is not used, bridge it with the common contacts (-).

LIMIT SWITCHES

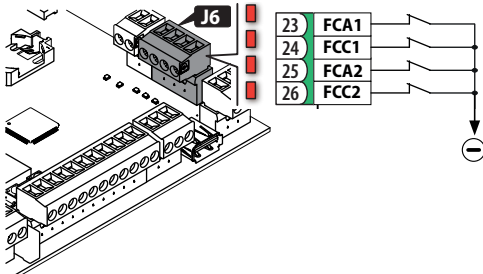

If no limit switches are used, there is no need to bridge the inputs (NC). If at least one limit switch is used, any unused contacts must be bridged with the common contacts (-).

- | | | |
|----|------|-----------------------------------|
| 23 | FCA1 | Opening limit switch motor 1 (NC) |
| 24 | FCC1 | Closing limit switch motor 1 (NC) |
| 25 | FCA2 | Opening limit switch motor 2 (NC) |
| 26 | FCC2 | Closing limit switch motor 2 (NC) |

To configure connections and functions, see § Accessories.

BUS 2EASY DEVICES

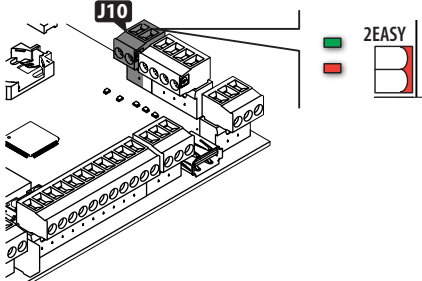

i If no BUS 2easy devices are used, leave the terminals free.

For connecting and assigning addresses see § Accessories.
 Do not exceed the maximum load of 500 mA.

ACCESSORIES POWER SUPPLY

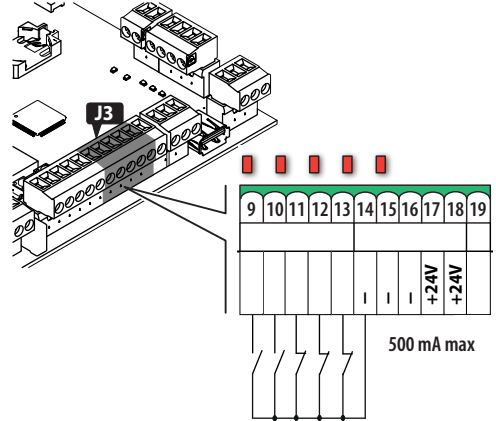

The E145S supplies 24 V \equiv and is short-circuit protected with a maximum current of 500 mA for connected accessories.

14...16	-	Common contacts / Accessories power supply negative
17, 18	+24V	Accessories power supply positive

OUTPUTS

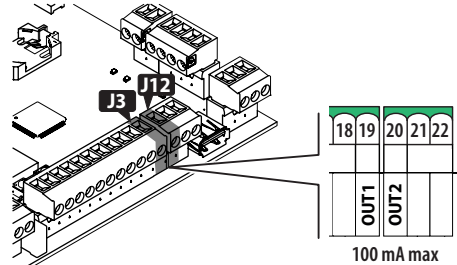

The E145S has two Open Collector outputs that are activated according to programming functions α_1 and α_2 .

OUT active	OUT not active
0 V \equiv	open circuit

Do not exceed the maximum load of 100 mA for each output.

ELECTRIC LOCKS

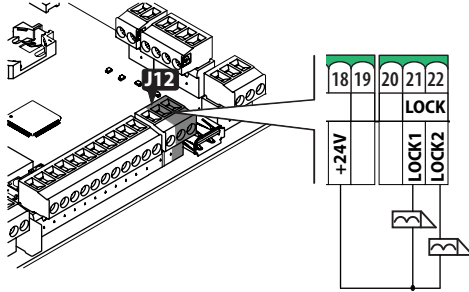

The E145S can control up to two electric locks to block the leaves in the closed position.

21 LOCK1 Electric lock on leaf operated by motor 1

22 LOCK2 Electric lock on leaf operated by motor 2

If the Bus 2easy encoder is installed and enabled, the electric lock is activated only just before the leaf opens from the closed position.

If the Bus 2easy is not enabled, the electric lock is activated before each opening movement, irrespective of the position of the leaf.

Use FAAC 12 V~/24 V=== electric locks or generic 24 V==/0.5A electric locks with a maximum current of 3 A.

RADIO RECEIVER/DECODER BOARD

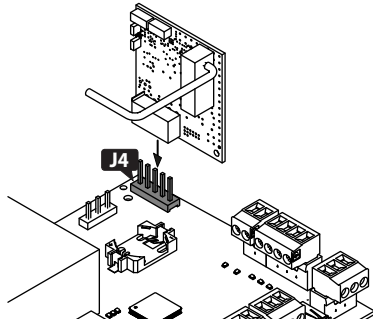

The quick insertion connector J4 is specifically for 5-pin FAAC radio or decoder boards.

Insert as shown in the figure.



If a FAAC model RP receiver is used, it is recommended to install the appropriate external antenna in order to obtain a sufficient range.

XF RADIO MODULE

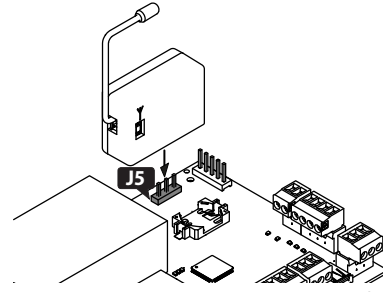

The quick insertion connector J5 is specifically for FAAC model XF radio modules.

Insert as shown in the figure.

To memorize radio control codes see § Accessories.

FLASHING LIGHT

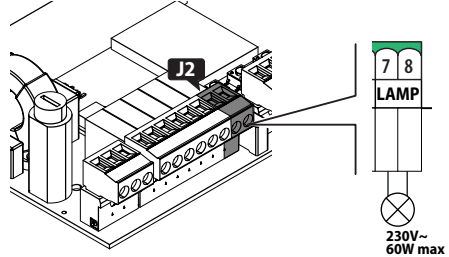

The flashing light indicates that the gate is moving and must be installed in a position that is visible from both sides of the gate.

The flashing light must be a 230 V~, max 60 W model. Pre-flashing of 3 s before movement can be enabled via programming function PF.

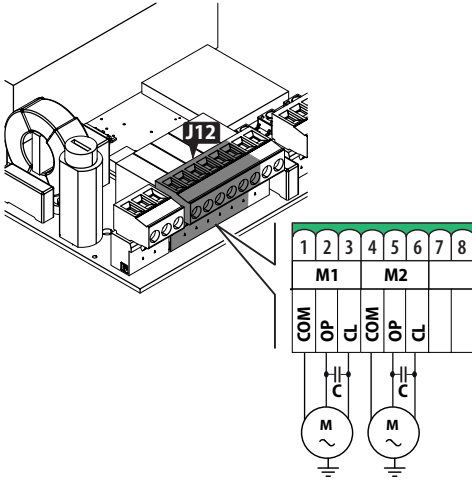

COM	Motor COMMON contact
OP	PHASE to open the electric motor
CL	PHASE to close the electric motor
C	Thrust capacitor

For single operator installations, connect the motor to terminals M1.

For double operator installations, connect:

- the motor that opens first to terminals M1
- the motor that closes first to terminals M2

! The operators **MUST** be connected to the earth of the electrical system.

MAINS POWER SUPPLY

! Carry out the following operations with the power supply disconnected.

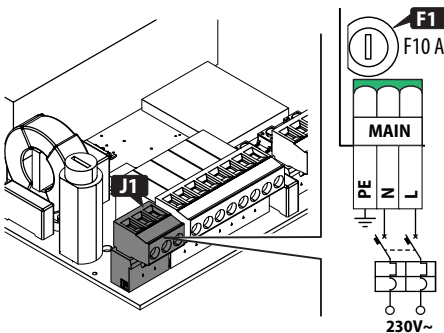

Connect the Phase (L) and Neutral (N) to the 230 V~

power supply.

The board has a 10 A fuse on the Phase.

Connect the earth of the electrical system to terminal PE.

6. SET-UP

RISKS

PERSONAL PROTECTIVE EQUIPMENT

Carry out following (§ specific sections).

1. Turn power on to the board.
2. Check that the status of the LEDs is correct.
3. Configure the type of automation (Basic programming, cF) and the number of motors (Basic programming, n).
4. Enable the encoders, if present (Basic programming, En) and the limit switches (Basic programming, FR, FC).
5. Check the leaf movement (Basic programming, n2, n1).
6. Carry out the SETUP procedure that includes the registration of BUS 2easy that are connected (Basic programming, tL).
7. Memorise the radio controls, if used.
8. Complete the required programming.
9. Carry out the final checks to make sure that the automation system is working correctly with all the devices installed.

6.1 TURN POWER ON TO THE BOARD

Turn on the mains power supply; the 5 V and 24 V LEDs come on and the following appears on the display: b0, then the FW version (e.g. 4.0), then 50 (SETUP required).

If the SETUP has already been carried out b0, appears on the display and then the automation status (e.g. 00) For LED and display signals see § Diagnostics.

6.2 PROGRAMMING

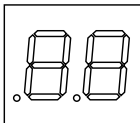

When the display shows the automation status, you can enter basic or advanced programming mode.

■ Basic programming

1. Press and hold the **F** button:
The first function (□□) appears on the display, which is displayed as long as button F remains pressed.
2. Release the button: the display shows the value of the function.
3. Press the **+** or **-** button to modify, then press the **F** button to confirm to go to the next function. Proceed in the same way for all the functions.

■ Advanced programming

1. Press and hold down the **F** button, then the **+** button as well:
The first function (b□) appears on the display, which is displayed as long as button F remains pressed.
2. Release the buttons: the display shows the value of the function.
3. Press the **+** or **-** button to modify, then press the **F** button to confirm to go to the next function. Proceed in the same way for all the functions.

■ Exiting programming mode



Every modified value becomes effective immediately, but when exiting from programming mode you have to decide whether to save the modifications or not. Modifications are lost if no buttons have been pressed for 10 minutes or if power to the board is disconnected before they have been saved.

1. Press and hold down the **F** button, then the **+** button as well.
Alternatively, scroll through the programming menu until you reach the last function (5t).
2. Select:
t = save the changes
n = DO NOT save the changes
3. Press button **F** to confirm: the display reverts to the automation status view.

2 BASIC programming menu

Function	default
JC SIMPLY CONNECT To enable Simply Connect, select a communication channel: 0 disabled 1 (CH1), 2 (CH2), 3 (CH3), 4 (CH4)	0
CF TYPE OF AUTOMATION 1 swing gate 2 sliding gate	1
df DEFAULT CONFIGURATION Displays Y if the programming corresponds to the default settings. Select Y if you wish to reload the default values for the type of automation. Y the programming corresponds to the DEFAULT settings n0 the programming DOES NOT correspond to the default settings	Y
Lo FUNCTIONING LOGIC <ul style="list-style-type: none"> E Semi-automatic EP Semi-automatic step by step S Automatic Safety SA Automatic Safety 2 SP Automatic Safety Step by Step AI Automatic 1 A Automatic AP Automatic Step by Step AT Automatic with Timer Function b Semi-automatic b bC Mixed (Impulse opening / Hold-to-run closing) C Hold-to-run 	E
PA PAUSE TIME (displayed only if an automatic logic has been selected) Displayed in seconds up to 59, then in steps of 10 s. 00...59 (Adjustment step: 1 s) 1.0...9.5 (Adjustment step: 10 s)	30
Pb PARTIAL PAUSE TIME (displayed only if an automatic logic has been selected) Carried out after partial opening. Displayed in seconds up to 59, then in steps of 10 s. 00...59 (Adjustment step: 1 s) 1.0...9.5 (Adjustment step: 10 s)	30
n0 NUMBER of MOTORS connected 1 1 motor 2 2 motors	2

Function	default
F1 MOTOR 1 POWER 01...50 (levels; 50 = maximum power)	25
F2 MOTOR 2 POWER (displayed only if $n0 = 2$) 01...50 (levels; 50 = maximum power)	25
En ENCODER Enables/disables the encoder on both motors. n0 disabled Y enabled	n0
FA OPENING LIMIT SWITCH (displayed only if $CF = 1$) Enables/disables the opening limit switches, to stop the automation or start the slowdown. Modifying the value requires a new SETUP. n0 disabled 01 stop 02 start slowdown	n0
FC CLOSING LIMIT SWITCH (displayed only if $CF = 1$) Enables/disables the closing limit switches, to stop the automation or start the slowdown. Modifying the value requires a new SETUP. n0 disabled 01 stop 02 start slowdown	n0
So INPUT EDGE1 CONFIGURATION <ul style="list-style-type: none"> nC Sensitive edge with NC contact 1r 1 Resistive sensitive edge 8.2 kΩ 2r 2 Resistive sensitive edges 8.2 kΩ (Connected in parallel) 	nC
Sc INPUT EDGE2 CONFIGURATION <ul style="list-style-type: none"> nC Sensitive edge with NC contact 1r 1 Resistive sensitive edge 8.2 kΩ 2r 2 Resistive sensitive edges 8.2 kΩ (Connected in parallel) 	nC
Br BRAKING FOR SLIDING GATE (displayed only if $CF = 2$) 00 braking disabled 01...10 (levels; 10 = maximum braking)	05
Cd LEAF CLOSING DELAY (displayed only if $n0 = 2$) The delay is applied to MOTOR 1. Displayed in seconds up to 59, then in steps of 10 s. 00...59 (Adjustment step: 1 s) 1.0...1.3 (Adjustment step: 10 s)	05

3 ADVANCED programming menu

Function	default
bu Learn BUS 2easy devices See the relative section.	
n2 MOTOR 2 OPERATION in dead man mode (displayed only if $\Pi n = 2$) + OPEN (displaying $\square P$) - CLOSE (displaying $\square L$)	--
n1 MOTOR 1 OPERATION in dead man mode + OPEN (displaying $\square P$) - CLOSE (displaying $\square L$)	--
EL SETUP See the relative section.	--
St LEAVING THE PROGRAMMING MODE y exit saving the settings no exit without saving the settings After having confirmed using button F , the display indicates the STATUS of the automation:	y
00 CLOSED	08 CHECK Bus 2easy
01 OPEN	09 PREFLASHING BEFORE OPENING
02 STATIONARY THEN OPENS	10 PREFLASHING BEFORE CLOSING
03 STATIONARY THEN CLOSES	11 EMERGENCY OPEN
04 IN PAUSE	12 EMERGENCY CLOSE
05 OPENING	HP HOLD POSITION
06 CLOSING	. (flashing) SLEEP
07 FAILSAFE IN PROGRESS	

Function	default
b0 MAXIMUM TORQUE AT INITIAL THRUST When it starts, the motor operates at maximum power for the time set in this option. 01...10 (Adjustment step: 1 s)	01
CS CLOSING THRUST (not displayed if $FC = 1$) This function assists the closing of the electric lock: it pushes against the closing stop with maximum force for 2s. DO NOT enable the function if there is not a mechanical closing stop fitted. no disabled y enabled	no
RS REVERSE STROKE FOR OPENING (not displayed if $FC = 1$) This function assists the release of the electric lock: it pushes against the closing stop before opening. DO NOT enable the function if there is not a mechanical closing stop fitted. no disabled y enabled	no
0d LEAF OPENING DELAY (displayed only if $\Pi n = 2$) The delay is applied to MOTOR 2. Displayed in seconds up to 59, then in steps of 10s. 00...59 (Adjustment step: 1 s) 1.0...1.3 (Adjustment step: 10 s)	02
IP REVERSE ON OBSTACLE This function specifies the amount the leaf is reversed after an obstacle has been detected. no total reverse y partial reverse (2 s)	no
r1 SLOWDOWN LEAF 1 (NOT displayed if $FA/FC = 2$) Specifies the deceleration space for the leaf connected to MOTOR 1 (% of the total length of travel). 01...50 (Adjustment step: 1%)	20
r2 SLOWDOWN LEAF 2 (NOT displayed if $FA/FC = 2$, or if $\Pi n = 1$) Specifies the deceleration space for the leaf connected to MOTOR 2 (% of the total length of travel). 01...50 (Adjustment step: 1%)	20

ENGLISH

Translation of the original instructions

Function	default
PF PRE-FLASHING Enables/disables pre-flashing and specifies when it is activated. The pre-flashing time is fixed: 3 s.	no
no disabled	
OC for any movement	
CL when closing	
OP when opening	
PA when the pause time elapses	
Ph CLOSING PHOTOCELLS Specifies the operation of the closing photocells.	no
no reopen immediately	
Y reopen when the photocells are released	
Ad ADMAP FUNCTION Enables/disables operation in accordance with French standard NFP 25/362.	no
no disabled	
Y enabled	
EC ANTI-CRUSHING SENSITIVITY (displayed only if $E_n = Y$) This function species the speed with which the anti-crushing system triggers after an obstacle has been detected.	06
00...10 (levels, 10=maximum sensitivity)	
rB SEARCH FOR STOP (displayed only if $E_n = Y$ and $FA/FC = no$ or 2) This function specifies the angular space in which to search for the opening/closing stop. In this space, the automation is stopped by a mechanical stop/obstacle and not by the anti-crushing system. Displayed in degrees and tenths of a degree (separated by a point) up to 9.9, then it is in degrees.	4.0
0.3...9.9 (Adjustment step: 0.1°)	
10...20 (Adjustment step: 1°)	
tA ADDITIONAL OPERATING TIME (displayed only if $E_n = no$ and $FA/FC = no$ or 2) Adds additional operating time at the end of the movement.	03
00...30 (Adjustment step: 1 s)	

Function	default
o1 OUT1 Function of output OUT1.	00
00 disabled	
01 FAILSAFE	
02 LED (lit during OPENING and in OPEN/PAUSE, off in CLOSED, flashing in CLOSING)	
03 timed COURTESY LIGHT	
04 ERROR active	
05 automation OPEN or PAUSED	
06 automation CLOSED	
07 automation MOVING	
08 automation IN EMERGENCY	
09 automation OPENING	
10 automation CLOSING	
11 electric lock OPERATION	
12 PHOTOCELL active	
13 TRAFFIC LIGHT function (active during OPENING and with automation OPEN)	
14 timed output that can be activated from the 2 nd radio channel OMNIDEC	
15 output (step-by-step function) that can be activated from the 2 nd radio channel OMNIDEC	
16 active during the movement of MOTOR 1	
17 active during the movement of MOTOR 2	
18 INTRUSION alarm (only with encoder installed)	
t1 OUT1 TIMING (displayed only if $o1 = 03/11/14$) Sets the activation duration of output OUT1 if a timed function is programmed.	02
01...30 (Adjustment step: 1 min if $o1 = 03/14$, 1 s if $o1 = 11$)	
o2 OUT2 Function of output OUT2 (with the same options as o1).	02
t2 OUT2 TIMING Timing of output OUT2 (with the same options as t1).	02
AS MAINTENANCE REQUEST Enables/disables the maintenance alert when the programmed number of cycles has been reached as specified in the following functions (rc, rd).	no
no disabled	
Y enabled	

Function	default
nc THOUSANDS OF CYCLES Displays the thousands of cycles that have been performed. To reset the cycle counter: press + and - for 5 s 00...65 (programmable if AS = 4)	00
nd TENS OF CYCLES Displays the tens of cycles that have been performed. 00...53 (if AS = n0) 00...65 (programmable if AS = 4)	00
St LEAVING THE PROGRAMMING MODE 4 exit saving the settings n0 exit without saving the settings After having confirmed using button F , the display indicates the STATUS of the automation:	4
00 CLOSED	08 CHECK Bus 2easy
01 OPEN	09 PREFLASHING BEFORE OPENING
02 STATIONARY THEN OPENS	10 PREFLASHING BEFORE CLOSING
03 STATIONARY THEN CLOSES	11 EMERGENCY OPEN
04 IN PAUSE	12 EMERGENCY CLOSE
05 OPENING	HP HOLD POSITION
06 CLOSING	. (flashing) SLEEP
07 FAILSAFE IN PROGRESS	

6.3 OPERATING LOGICS



the STOP command has priority in all the logics and stops the automation.
The CLOSE command always closes the automation.

■ E SEMI-AUTOMATIC

This logic only uses the OPEN command.

OPEN if the automation is closed, causes it to open.

OPEN if the automation is open, causes it to close.

OPEN during opening, stops the gate and the next OPEN command closes it.

OPEN during closing, causes it to reopen.

The triggering of the photocells: during movement, reverses the gate.

■ EP SEMI-AUTOMATIC STEP-BY-STEP

This logic only uses the OPEN command.

OPEN if the automation is closed, causes it to open.

OPEN if the automation is open, causes it to close.

OPEN during opening or closing, stops the gate and the next OPEN command reverses the direction.

The triggering of the photocells: during movement, reverses the gate.

■ S AUTOMATIC SAFETY

This logic only uses the OPEN command.

OPEN if the automation is closed, causes it to open. The automation closes automatically after the pause time has elapsed.

OPEN during opening, causes it to close.

OPEN during pause, causes it to close.

OPEN during closing, causes it to reopen.

The triggering of the closing photocells: during pause, closes the gate - during opening, requests closing - during closing, causes the gate to reverse and then closes it immediately.

■ SA AUTOMATIC SAFETY 2

This logic only uses the OPEN command.

OPEN if the automation is closed, causes it to open. The automation closes automatically after the pause time has elapsed.

OPEN during opening, is ignored.

OPEN during pause, causes it to close.

OPEN during closing, causes it to reopen.

The triggering of the closing photocells: during pause, reloads the pause time.

■ SP AUTOMATIC STEP BY STEP

This logic only uses the OPEN command.

OPEN if the automation is closed, causes it to open. The automation closes automatically after the pause time has elapsed.

OPEN during pause, causes it to close.
 OPEN during opening or closing, stops it and the next OPEN command reverses the direction.
 The triggering of the closing photocells: during pause, closes the gate - during opening, requests closing - during closing, causes the gate to open and then closes it immediately.

■ R1 **AUTOMATIC1**

This logic only uses the OPEN command.
 OPEN if the automation is closed, causes it to open. The automation closes automatically after the pause time has elapsed.
 OPEN during opening, is ignored.
 OPEN during the pause, resets the pause time.
 OPEN during closing, causes it to reopen.
 The triggering of the closing photocells: during pause, closes the gate - during opening, requests closing - during closing, causes the gate to reverse and then closes it immediately.

■ R **AUTOMATIC**

This logic only uses the OPEN command.
 OPEN if the automation is closed, causes it to open. The automation closes automatically after the pause time has elapsed.
 OPEN during the pause, resets the pause time.
 OPEN during opening, is ignored.
 OPEN during closing, causes it to reopen.
 The triggering of the closing photocells: during pause, reloads the pause time.

■ RP **AUTOMATIC STEP-BY-STEP**

This logic only uses the OPEN command.
 OPEN if the automation is closed, causes it to open. The automation closes automatically after the pause time has elapsed.
 OPEN during pause, stops the gate and the next OPEN command closes it.
 OPEN during opening, stops the gate and the next OPEN command closes it.
 OPEN during closing, causes it to reopen.
 The triggering of the closing photocells: during pause, reloads the pause time.

■ Rt **AUTOMATIC TIMER**

This logic only uses the OPEN command.
 OPEN if the automation is closed, causes it to open. The automation closes automatically after the pause time has elapsed. If an OPEN input is active at power up, it opens, otherwise it closes.
 OPEN during the pause, resets the pause time.
 OPEN during opening, is ignored.
 OPEN during closing, causes it to reopen.

The triggering of the closing photocells: during pause, reloads the pause time.

■ b **SEMI-AUTOMATIC b**

This logic uses the OPEN A commands to open and OPEN B (CLOSE) to close. Partial motion is not available.
 OPEN if the automation is closed, causes it to open.
 OPEN during closing, causes it to reopen.
 If the photocells are triggered: the direction of movement is reversed.

■ bC **MIXED (b during opening, C during closing)**

This logic uses the OPEN A (OPEN) impulse command to open, and maintained OPEN B (CLOSE) to close. Partial motion is not available.

 A maintained command must be activated intentionally and the automation must be visible.

OPEN opens the automation.
 CLOSE maintained, closes the automation (when opening, a non-maintained CLOSE command stops it).
 OPEN during closing, causes it to reopen.
 The triggering of the closing photocells reverses the direction of movement, the triggering of the opening photocells stops the movement.

■ C **DEAD-MAN**

This logic uses the maintained commands OPEN A (OPEN) to open and OPEN B (CLOSE) to close. Partial motion is not available.

 A maintained command must be activated intentionally and the automation must be visible.

Maintained OPEN opens the automation.
 Maintained CLOSE closes the automation.
 If the photocells are triggered: movement is stopped.

6.4 SETUP

The SET-UP procedure consists of a series of movements during which the board acquires the length of travel and other leaf parameters. The SETUP procedure also registers the BUS 2easy devices that are present.

SETUP needs to be carried out:

- when S0 flashes on the display (e.g. when the automation is first put into operation)
- after a board has been replaced
- if you wish to modify the length of travel of the leaves
- if there are active errors that require the SETUP procedure to be carried out
- if programming functions are modified that require a new SETUP

Checks prior to SETUP:

- the automation must not be set to manual mode
- the STOP input, if not used, must be bridged
- make sure that the settings of the following functions in Basic Programming are correct:
 - cF type of automation
 - fn number of motors
 - En encoder (has to be enabled, if present)

 While the SETUP procedure is being carried out, prevent transit in the area of movement of the leaves because the safety devices are disabled.

1. Go to the H function in basic programming. The value displayed is --. The leaves must be closed. To close them now, press the + button for Leaf1 and the - button for Leaf2.
2. Press the + and - buttons simultaneously for a few seconds. The display flashes, then the first movement starts and S1 appears on the display. Release the buttons.
3. SETUP starts. The display indicates the current phases with a flashing code (from S1 to S4, see  SETUP phases).

If the SETUP procedure doesn't start or stops before it has been completed, the board exits from programming mode and S0 flashes on the display: check the ERRORS that are present (Chapter § Diagnostics).

 **4 SETUP phases**

Display	Phase
S1	Leaf1 opens: searching for the OPEN position
S2*	Leaf2 opens: searching for the OPEN position
S3*	Leaf2 closes: searching for the CLOSED position
S4	Leaf1 closes: searching for the CLOSED position
	SETUP has been completed. The board exits from programming mode and the display shows the automation status - closed.

* phase NOT carried out in the case of a single leaf automation.

The phases are carried out automatically in sequence. The open/closed position is recognised according to the system configuration:

■ **Timed operation**

An OPEN A command is sent as soon as the leaf reaches the mechanical stop.

■ **Operation with encoder**

The board automatically recognises the position if a mechanical stop is present.

If there is no mechanical stop, an OPEN A command is sent at the point in which you want the leaf to stop.

■ **Operation with limit switches (with or without encoder)**

If the limit switch is programmed to specify the stopping point, the board automatically recognises the position as soon as the limit switch is triggered.

If the limit switch is programmed to specify the slow-down point, it sends an OPEN A command as soon as the leaf reaches the mechanical stop.

■ **Sliding gate**

The board automatically recognizes the positions when each limit switch is triggered.

In this application, the limit switch is used only as a stop device.

 The limit switches in this application are indispensable.

6.5 CONFIGURING MOVEMENTS AND TIMING

In BASIC PROGRAMMING

- P_A **OPEN A pause time**, P_B **OPEN B pause time** In operating logics with automatic closing, the gate remains open for the pause time (configurable specifically for full or partial opening).
- n_1 **Number of motors** Before carrying out the SETUP procedure, the number of motors has to be configured in order to specify single or two leaf operation.
- F_A **Opening limit switch**, F_C **Closing limit switch** If present, the limit switches must be enabled, either for stopping or slowing down the leaf.
- d **Leaf closing delay** This function is used in 2-leaf automations to prevent interference between leaves and to handle any overlap.

In ADVANCED PROGRAMMING

- b_0 **Maximum force at initial thrust time** When it starts, the motor works at maximum force for a few seconds, ignoring the limits set in basic programming (F_1 , F_2). Increase the time in the case of particularly high friction.
- d **Leaf opening delay** This function is used in 2-leaf automations to prevent interference between leaves and to handle any overlap.

6.6 ADJUSTING THE ANTI-CRUSHING SYSTEM

Anti-crushing protection is obtained by limiting the static force exerted by the operator in the event of impact with an obstacle. When an obstacle is detected, the board also issues a reverse command (partial or complete, according to function I^P).

Obstacle detection is via the encoder (if present) or via the activation of a safety edge.

The functions used for adjusting the anti-crushing system are listed below. Some allow the static force or the kinetic energy of the leaf on the obstacle to be limited; others configure the reverse on obstacle. Adjust the functions together, taking into consideration the configuration of the automation and the conditions of use. For example, in particularly windy areas, with panelled leaves, if the sensitivity of the anti-crushing system is too high, it can cause frequent unwanted reversals to occur.

In BASIC PROGRAMMING

- F_1 **Motor 1 Power**, F_2 **Motor 2 Power** Decrease the value if you want to limit the static force in the event of impact.
- E_n **Encoder** If encoders are installed, they must be enabled to detect obstacles.
- r_B **Search for stop** Reverse on obstacle via encoder is not active in the search for stop space.

In ADVANCED PROGRAMMING

- I^P **Reverse on obstacle** Specifies the amount by which the leaf is reversed: complete or for 2 s.
- r_1 , r_2 **Slowdown Leaf1, Leaf2** Specifies the extent of the leaf slowdown near the open / closed positions. Alternatively, the slowdown enabled limit switch can be used (F_A , F_C in basic programming). The slowdown allows you to limit the inertial forces and reduce the vibrations of the gate when it is stopping.
- E_C **Anti-crushing sensitivity** Specifies the speed at which the anti-crushing system triggers after an obstacle has been detected by the encoder.

7. PUTTING INTO SERVICE

7.1 FINAL CHECKS

1. Make sure that the forces generated by the gate are within the limits permitted by the current regulations. Use an impact force tester in accordance with EN 12453. For non-EU countries, if there are no specific local regulations, the force must be less than 150 N. If necessary, make any adjustments that may be needed by referring also to the operator instructions.
2. Carry out a complete functional test of the automation and all the installed devices.
3. Refer to the operator instructions for any additional tests that may be required.

7.2 CLOSE THE ENCLOSURE

Close the enclosure in which the board is housed by referring to the specific instructions.

7.3 FINAL OPERATIONS

Make sure that the system delivery requirements have been fulfilled (otherwise arrange for them) i.e. that they correspond to the board installed / replaced.

8. ACCESSORIES

8.1 RELAY PHOTOCELLS

! Photocells are additional type D detection devices (according to EN 12453) that reduce the likelihood of contact with the moving leaf. The photocells are not safety devices according to standard EN 12978. Detection devices used as safety accessories (e.g. sensitive edges) to protect against a hazard, must comply with standard EN 12978.

i Use photocells with a NC relay contact. If multiple photocells are used, the contacts must be connected in series.

Position and connect the photocells according to their required use:

FSW CL	Photocell active during closing
FSW OP	Photocell active during opening
FSW OP/CL	Photocell always active

i The action carried out when the photocells are triggered depends on the operating logic selected.

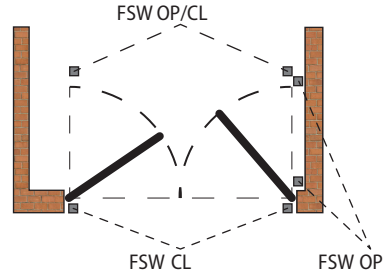

■ Failsafe

Failsafe is a functional test that is carried out before a movement. It consists of momentarily interrupting the power supply to the devices and checking the change in status of the input.

If the test fails, the board generates an error and prevents the automation from moving.

To enable the Failsafe test: connect the negative of the photocell transmitters to an output (OUT1/OUT2) configured as a Failsafe function (o1 or o2=□1) instead of to the accessories power supply negative (-).

1 pair of closing or opening photocells

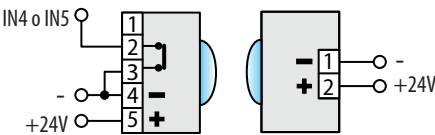

1 pair of opening and closing photocells

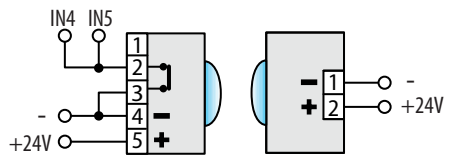

2 pairs of closing or opening photocells

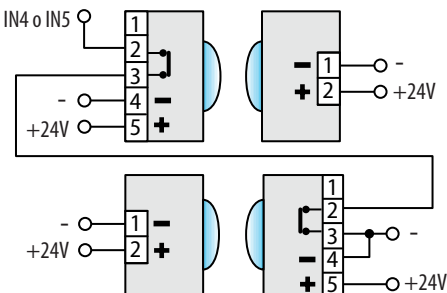

1 pair of closing photocells and 1 pair of opening and closing photocells

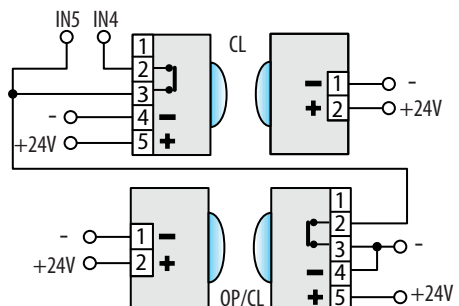

8.2 SENSITIVE EDGES



If the sensitive edge is used to protect against a hazard, it must comply with standard EN 12978.

The E145S board has two inputs for connecting sensitive edges that are active during opening (EDGE1) or during closing (EDGE2).

The activation of a sensitive edge causes the direction of movement to reverse, which can be:

- complete if $iP = n0$ in programming
- partial (2 s) if $iP = 4$ in programming

The EDGE1 and EDGE2 inputs can be configured to connect the following types of devices:

- with NC contact ($S0/Sc = nc$)
- 1 resistive edge $8.2\text{ k}\Omega$ ($S0/Sc = 1r$)
- 2 resistive edges $8.2\text{ k}\Omega$ connected in parallel ($S0/Sc = 2r$)

DO NOT connect photocells to inputs EDGE1/EDGE2.

1. Configure the input to which the sensitive edge is connected according to the type used (functions $S0/Sc$ in programming).
2. If the connected device requires a functional test to be carried out, use an output (OUT1/OUT2) configured as Failsafe ($o1$ or $o2=01$).

8.3 LIMIT SWITCHES

The limit switch inputs are disabled by default.

To enable the inputs and specify the function of the connected limit switches (stop movement or start slowdown) use parameters FR and FC in basic programming.

If no limit switches are used, there is no need to bridge the inputs (NC). If at least one limit switch is used, any unused contacts must be bridged with the common contacts (-).

These inputs can be used to connect the Gatecoder accessory (also in combination with the limit switches, if present).

Use parameter En to enable the encoder.

Limit switches

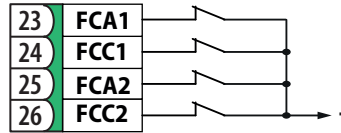

Gatecoder

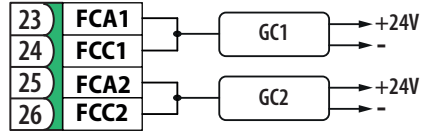

Gatecoder + Limit switch

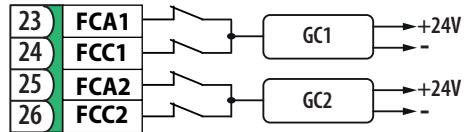

GC1 Gatecoder for Leaf1

GC2 Gatecoder for Leaf2



8.4 BUS 2EASY DEVICES

It is possible to connect FAAC BUS 2easy devices (photo-cells, sensitive edges, control devices) to this board.

i If no BUS 2easy accessories are used, leave connector J10 free. Do not bridge.

CONNECTION

Connecting the BUS 2easy devices to connector J10.

i The overall length of the BUS 2easy cables must not exceed 100 m.
The BUS line does not require a matching polarity connection (apart from the encoder connection, see specific section).

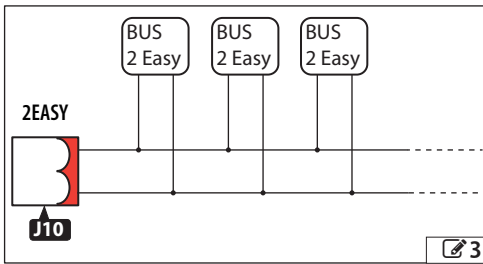

BUS 2EASY PHOTOCELLS

! Photocells are additional type D detection devices (according to EN 12453) that reduce the likelihood of contact with the moving leaf. The photocells are not safety devices according to standard EN 12978. Detection devices used as safety accessories (e.g. sensitive edges) to protect against a hazard, must comply with standard EN 12978.

Type of use:

FSW CL	Photocell active during closing
FSW OP	Photocell active during opening
FSW OP/CL	Photocell always active
OPEN	Photocell for OPEN A

i The action carried out when the photocells are triggered depends on the operating logic selected.

1. Assign an address to the BUS 2easy photocells by setting the four DIP switches on both the transmitter and the corresponding receiver.

i The transmitter and receiver of a pair of photocells must have the same DIP switch settings. There must never be two or more pairs of photocells with the same DIP switch settings. If there is more

than one pair of photocells with the same address, a conflict error is generated.

2. Register the BUS 2easy photocells (see specific section).
3. Check the BUS 2easy devices (see specific section) and make sure that the automation operates according to the type of photocell installed.

5 Assigning an address to the Photocells

Key: 0=OFF , 1=ON

1 0 0 0	
1 0 0 1	
1 0 1 0	FSW CL
1 0 1 1	
1 1 0 0	
1 1 1 0	
0 0 0 0	
0 0 0 1	
0 0 1 0	FSW OP
0 0 1 1	
0 1 1 1	
0 1 0 0	FSW OP/CL
0 1 0 1	
1 1 1 1	OPEN



BUS 2EASY SENSITIVE EDGES

! If the sensitive edge is used to protect against a hazard, it must comply with standard EN 12978.

Type of use:

CL EDGE	Sensitive edge active during closing
OP EDGE	Sensitive edge active during opening

The activation of a sensitive edge causes the direction of movement to reverse, which can be:

- complete if $i^P = r_0$ in programming
- partial (2 s) if $i^P = \exists$ in programming

1. Assign an address to the device electronics by setting the four DIP switches.

i No two devices should have the same DIP switch settings. If there is more than one device with the same address, a conflict error is generated.

2. Register the device (see specific section).
3. Check the BUS 2easy devices (see specific section) and make sure that the sensitive edges are working correctly. When the gate is moving, activate the sensitive edge using an obstacle and make sure

that the automation operates according to the type of sensitive edge installed.

6 Addressing Sensitive Edges

Key: 0=OFF , 1=ON

1	1	0	1	CL EDGE
0	1	1	0	OP EDGE



BUS 2EASY ENCODER

1. Connect the cables of the encoder to the 2EASY terminal board.
2. After turning on power to the board, check the LEDs on each encoder with the leaf stationary:

DL1 lit = encoder powered

DL2 lit = encoder connected to **MOTOR1**

DL2 off = encoder connected to **MOTOR2**

i For each encoder that does not appear to be connected to the correct leaf, temporarily disconnect the power supply and invert the 2 wires on the 2EASY terminal board.

3. Register the devices (see specific section).
4. Check the BUS 2easy devices(see specific section).

SAFEcoder

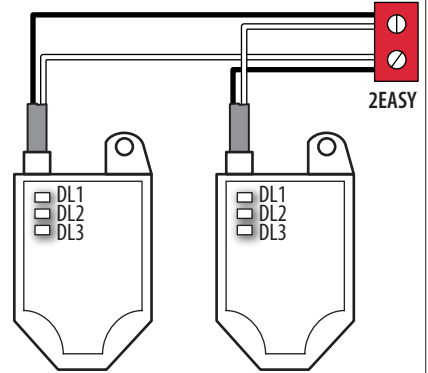

S800H ENC

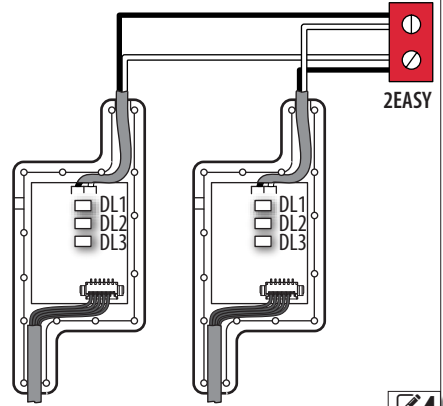

Correct connections

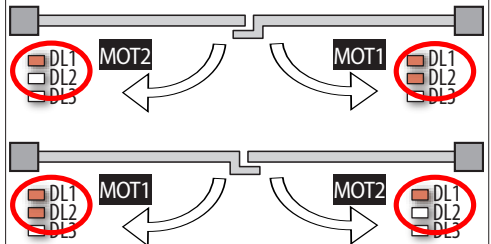
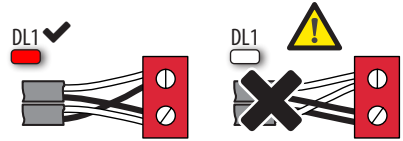



DL2 on = encoder connected to **MOT1**

DL2 off = encoder connected to **MOT2**

BUS 2EASY CONTROL DEVICES

 Do not use the BUS 2easy line for emergency stop commands.

1. Configure the DIP switches on the device to assign 1 or 2 commands.
-  Stop NC also generates a stop when the device is disconnected. A command (e.g.: OPEN A_1) must be used on only one of the connected devices.
2. Register the device (see specific section).
3. Check the BUS 2easy devices (see specific section) and make sure that the automation operates according to the type of control devices installed.

 **7 Addressing Control Devices**

Key: 0=OFF , 1=ON

DIP switch 5 enables the device for 1 (OFF) command or 2 (ON) commands



0 0 0 0 0	Open A_1	0 0 0 0 1	Open A_1	Open B_1
0 0 0 1 0	Open A_2	0 0 0 1 1	Open A_1	Open B_2
0 0 1 0 0	Open A_3	0 0 1 0 1	Open A_1	Stop
0 0 1 1 0	Open A_4	0 0 1 1 1	Open A_1	Close
0 1 0 0 0	Open A_5	0 1 0 0 1	Open A_2	Open B_1
0 1 0 1 0	Stop	0 1 0 1 1	Open A_2	Open B_2
0 1 1 0 0	Stop NC_1	0 1 1 0 1	Open A_2	Stop
0 1 1 1 0	Stop NC_2	0 1 1 1 1	Open A_2	Close
1 0 0 0 0	Close	1 0 0 0 1	Open A_3	Open B_3
1 0 0 1 0	Open B_1	1 0 0 1 1	Open A_3	Open B_4
1 0 1 0 0	Open B_2	1 0 1 0 1	Open A_3	StopNC_1
1 0 1 1 0	Open B_3	1 0 1 1 1	Open A_3	Close
1 1 0 0 0	Open B_4	1 1 0 0 1	Open A_4	Open B_3
1 1 0 1 0	Open B_5	1 1 0 1 1	Open A_4	Open B_4
1 1 1 0 0	/	1 1 1 0 1	Open A_4	StopNC_2*
1 1 1 1 0	/	1 1 1 1 1	Open A_4	Close

BUS 2EASY STATUS

To verify the BUS 2easy connection, check the 2EASY LEDs on the board:

BUS MON	●	At least one device is in operation
	○	NO devices in operation
BUS	●	OK
	○	SLEEPING
	✱	SHORT CIRCUIT
	✱	ERROR

The status of the BUS 2easy is also shown in the BU function in Basic Programming:

no	No device registered
-	At least one device registered
cc	BUS 2easy line short-circuited
Er	BUS 2easyline error

BUS 2EASY DEVICE REGISTRATION

Registration is required:

- when the automation system is first started or after the board has been replaced
- following any changes (addition, replacement or removal) to the BUS 2easy devices

Registration procedure:

The SETUP procedure registers the BUS 2easy devices that are connected. Alternatively, you can carry out the following procedure.

1. With the board powered, go to the BU function in basic programming. If there are no devices registered, no will appear on the display, otherwise segment 13 will be lit (6). Press the + and - simultaneously for at least 5 s. The display flashes, then H appears (registration complete).
2. Release the buttons.
3. Exiting from programming mode.

CHECKING THE BUS 2EASY DEVICES

1. Select parameter BU in basic programming. If there are no devices registered, NO will appear on the display, otherwise segment 13 will be lit. This menu can be used to check the operation of the registered devices: activate each device and check that the corresponding segment lights up (6).
2. Press and hold the + button and keep it pressed; the segments relative to the registered devices will come on. Each segment of the display corresponds to a type of device:

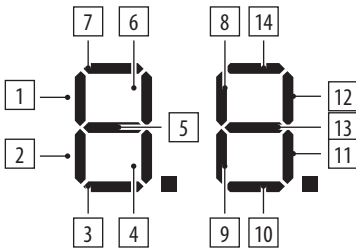

1	Open A control device
2	Open B control device
3	Closing photocells
4	Photocells for Open impulse
5	Opening/closing photocells
6	Close control device
7	Opening photocells
8	Stop control device
9	Closing sensitive edge
10	Encoder - leaf 2
11	Not used
12	Opening sensitive edge
13	BUS 2easy status
14	Encoder - leaf 1

6

8.5 XF RADIO MODULE

E145S is fitted with an OMNIDEC integrated two channel decoding system that can memorise, via the XF radio module, FAAC radio controls that use the following types of radio code: SLH/SLH LR, LC/RC, DS.

i The three types of radio codes can coexist simultaneously.

A maximum of 1600 codes can be memorised.

The memorised codes act as OPEN A or OPEN B/CLOSE commands.

The radio controls and the XF radio module must have the same frequency.

When memorising the codes, keep the radio control approximately one meter from the XF radio module.

1. Insert the XF radio module into the J4 connector, being careful to insert it in the right way round and with the mains power switched off.

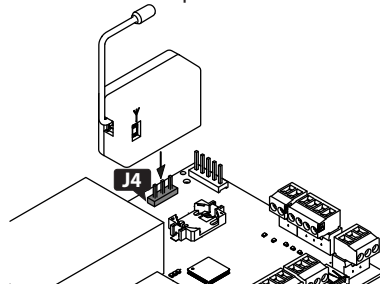

2. Turn power on to the board.
3. Memorise the radio controls.



Ensure that there are no obstacles (persons or things) while the automation is moving.

RADIO CONTROLS SLH/SLH LR

Memorise the first radio control, MASTER, on the board. Then add other radio controls that are required following the learning procedure that doesn't require you to access the board.

To check if the radio control is a MASTER device, press and hold a button and watch the LED:

- flashes briefly, then the light becomes steady = MASTER
- turns on immediately with a steady light = NON MASTER



Whenever a new master is memorised on the board, any SLH/SLH LR radio controls that are already in use are disabled.

■ Memorising the first radio control

1. On the board, press the + button (memorize OPEN A) or the - button (memorize OPEN B/CLOSE) and

- release it when the corresponding RADIO Led (**RADIO1** or **RADIO2**) starts to flash for 20 s (time available for the next steps).
- Press buttons **P1** and **P2** simultaneously on the radio control and release them when its LED starts to flash for 8 s (time available for the next step).
 - Press and release the button on the radio control to be memorised. The corresponding RADIO LED on the board becomes steady for 1 s, then switches off (memorisation complete).
 - Release the button.

When using the memorised button for the first time, press it twice in succession to obtain the command.

■ Adding radio controls

- Press buttons **P1** and **P2** simultaneously on the already memorised MASTER radio control and release them when its LED starts to flash for 8 s (time available for the next step).
- Within 8 seconds, press and hold the button that has already been memorised, the LED lights up with a steady light.
- Bring the radio control that has already been memorised, into contact face to face with the new one to be memorised.
- Press the button to be memorised on the new radio control and make sure that its LED flashes twice before turning off.
- Release all buttons.

When using the memorised button for the first time, press it twice in succession to obtain the command.

RADIO CONTROLS - RC/LC

■ Memorizing radio controls

- On the board, press the **+** button (memorize OPEN A) or the **-** button (memorize OPEN B/CLOSE) and release it when the corresponding RADIO Led (**RADIO1** or **RADIO2**) starts to flash for 20 s (time available for the next steps).
- Press and release the button on the radio control to be memorised. The corresponding RADIO LED on the board becomes steady for 2 s (memorisation completed), then starts to flash again. Another radio control can be memorised within 20 s.

The procedure ends after 20 s if no further radio controls are memorised and the RADIO LED switches off. To add additional radio controls, repeat the procedure from step 1.

■ Adding radio controls remotely

Use a LC/RC radio control that is already use by the automation, without having to use the board.

- Take a radio control that is already in use and move close to the board.

- Press buttons **P1** and **P2** simultaneously on the radio control that is already in use and release them when its LED starts to flash slowly for 5 s (time available for the next step).
- Press and release the button that has already been memorised (the corresponding RADIO LED on the board starts to flash for 20 s, the time available for the next step).
- Press the button to be memorised on the new radio control (the corresponding RADIO LED on the board becomes steady for 2 s to confirm the memorization. It then starts to flash again and another radio control can be memorised within 20 s). The procedure ends after 20 s if no further radio controls are memorised (the corresponding RADIO LED switches off). To add additional radio controls, repeat the procedure from step 1.

RADIO CONTROLS - DS

- Set the required combination of the DIP switches on the radio control (avoid setting them to all On or all Off).
- On the board, press the **+** button (memorize OPEN A) or the **-** button (memorize OPEN B/CLOSE) and release it when the corresponding RADIO Led (**RADIO1** or **RADIO2**) starts to flash for 20 s (time available for the next step).
- Press and release the button on the radio control to be memorised. The corresponding RADIO LED on the board becomes steady for 1 s and then switches off (memorisation complete).
- To memorize other radio controls, it is possible to set a DIP switch combination that has already been memorised or repeat the procedure for new combinations.

DELETING RADIO CONTROLS



This procedure cannot be reversed. It will delete ALL radio control codes that have been memorised as OPEN A and OPEN B/CLOSE. The deletion procedure is only active in the automation status display mode

- Press the **-** button and do not release it until the LED sequence has finished:
 - after 5 s the **RADIO2 LED** starts flashing slowly
 - after 5 s the **RADIO1** and **RADIO2 LED**s both start to flash quickly (deletion in progress)
 - after 5 s both the **LED**s come on steadily (deletion complete)
- Release the button, both **LED**s switch off after approximately 10 s.

8.6 SIMPLY CONNECT

! To safeguard people and property, the automation must be supervised and there must not be any unauthorised persons present for the entire duration of operations carried out remotely (SETUP and/or modifications to operating parameters).

i Simply Connect requires E1455 firmware version **FW 4.0** or later.
When programming is taking place via Simply Connect, programming via the board is inhibited.

1. With the board switched off, insert the module into the dedicated plug in connectors.
2. With the board powered, check the signalling LEDs (see module instructions).
3. Enable communication by assigning a channel (CH) to the board.

Basic programming, function \square C :

1 CH1, 2 CH2, 3 CH3, 4 CH4

IMPORTANT: if the automation is in a Multicom network, assign a different channel compared to the other boards that are connected.

4. Install the Simply Connect installer App (supplied with the module).

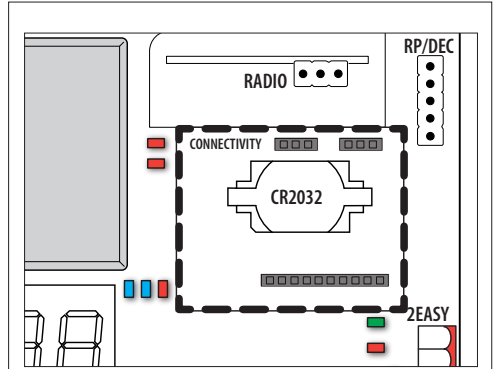

XMB GSM Mobile, Bluetooth Low Energy

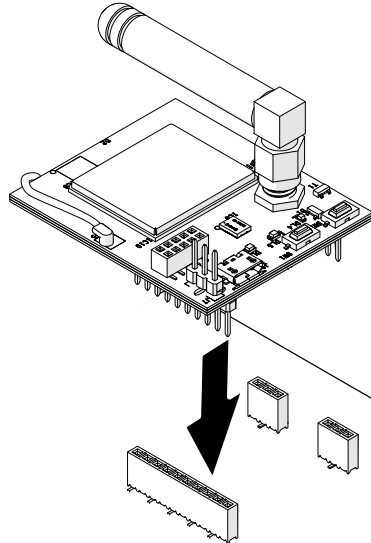

XWBL WiFi, LAN ethernet, Bluetooth Low Energy

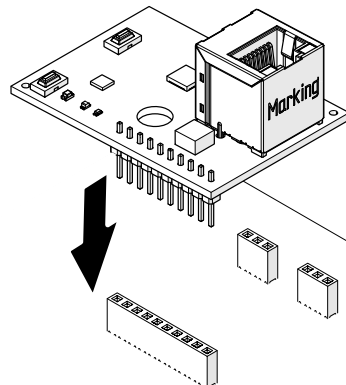

9. UPLOAD/DOWNLOAD

There is a USB port on the E145S board that can be used for the following:

- Load data from a USB pen drive (UPLOAD)
- saving data to a USB pen drive (DOWNLOAD).

i Use a USB storage device that has a maximum power consumption of 500 mA formatted with the FAT or FAT 32 file system. The NTFS format is not recognised by the board.

1. Turn the power off and insert the USB pen drive into the USB port on the Logic board and then switch on the board.
2. \square appears on the display and the USB LED comes on.
3. Press and release the **F** button to scroll through the Upload/Download menu options (see relative table).

UPLOAD OPERATIONS

i In order to be used, the files must be saved in the root directory of a USB memory device (not in a folder or a zip file and without their original names being changed).

Display	Function	File name
\square	Update FW	E145Ssw.cod
\square	Upload board configuration	E145.prg
\square	Not used	
\square	Upload radio codes	E145.rad

1. Press and hold the **+** and **-** buttons simultaneously for at least 5 seconds in order to carry out the function displayed.
 - the update starts: -- flashes on the display and the USB LED flashes. Release the buttons.
 - The procedure ends when \square appears on the display. If there are errors \square appears on the display and the red ERROR LED lights up. To display the error code, press buttons **+** and **-** simultaneously. The error messages are described in the Diagnostics Section.
2. Press **F** to return to the menu.

DOWNLOAD OPERATIONS

Display	Function	File name
\square	Download board configuration	E145.prg
\square	Not used	
\square	Download radio codes	E145.rad

1. To carry out the function displayed, press and hold the **+** and **-** buttons simultaneously for at least 5 seconds, until \square appears on the display.
2. Release the buttons and use the **+** or **-** buttons to select the method for saving the file to the root of the USB storage device:

\square saves the file without a suffix and overwrites any existing file with the same name in the USB memory (e.g. E145.prg)

\square saves the file by adding a 3-digit suffix to the name (e.g. E145000.prg) and if there is already a file with the same name in the root of the USB memory, the number of the suffix is incremented.

Note: the suffix must be deleted if you wish to load the file in the upload operation.

3. Press **F** to run.
 - The procedure ends when \square appears on the display. If there are errors \square appears on the display and the red ERROR LED lights up. To display the error code, press buttons **+** and **-** simultaneously. The error messages are described in the Diagnostics Section.
4. Press **F** to return to the menu.

10. DIAGNOSTICS

10.1 FIRMWARE VERSION

The firmware version is show on the display for 5 seconds each time it is switched on.

10.2 CHECKING THE MOVEMENT

Access basic programming and use function **12** for Leaf2 (displayed if the automation is configured for 2 leaves) and function **11** for Leaf1.

1. The function displays --.
2. Use buttons **+** and **-** in dead man mode. One of the expected commands must be given:

+ to OPEN (OP on the display)

- to CLOSE (CL on the display)

Otherwise, temporarily disconnect the power supply and invert the phases (OP/CL) of the motor.

10.3 AUTOMATED SYSTEM STATUS

The display, other than when in the programming menu, provides information regarding the status of the automation system (**8**).

8 Automated system status

00	CLOSED
01	OPEN
02	STATIONARY THEN OPENS
03	STATIONARY THEN CLOSES
04	IN PAUSE
05	OPENING
06	CLOSING
07	FAILSAFE IN PROGRESS
08	CHECK Bus 2easy
09	PREFLASHING BEFORE OPENING
10	PREFLASHING BEFORE CLOSING
11	EMERGENCY OPEN
12	EMERGENCY CLOSE
HP	HOLD POSITION
.	(flashing) SLEEP

10.4 LEDS CHECK

9 bold indicates the condition of the LEDs with the board powered, the gate at its halfway position and no connected device active (●=on ; ○=off).

9 Status of the LEDs

LED	colour	meaning	●	○
OPEN A	red	Total motion command	active	not active
OPEN B	red	Partial motion command	active	not active
STOP	red	Stop command	not active	active
FSW CL	red	Closing photocell	not active	active
FSW OP	red	Opening photocell	not active	active
EDGE1	red	Opening sensitive edge	not active	active
EDGE2	red	Closing sensitive edge	not active	active
FCA1	red	Opening limit switch Leaf1	not engaged	engaged
FCC1	red	Closing limit switch Leaf1	not engaged	engaged
FCA2	red	Opening limit switch Leaf2	not engaged	engaged
FCC2	red	Closing limit switch Leaf2	not engaged	engaged
5V	blue	Power supply 5 V	on	off
24V	blue	Accessories power supply 24 V	on	off
ERROR	red	Error signalling	error	no errors
BUS	red	Bus 2easy devices	see § Bus 2easy devices	
BUS MON	green	Bus 2easy devices	see § Bus 2easy devices	
USB	red	USB pen drive inserted (*)	Installed	not inserted
RADIO1	red	Channel 2 Omnidec (*)	active	not active
RADIO2	red	Channel 2 Omnidec (*)	active	not active

(*) Additional LED status or meanings are shown in the section on the accessory to which it refers.

10.5 ERROR CODES, ALARMS, INFO

When the ERROR LED is lit, notifications in progress can be seen on the display (e.g. E_r 07, or multiple notifications e.g. E_r 07 16):

- when the board is not in the programming menus, press **+** and **-** at the same time.

10 Errors, Alarms, Info		
Error (number on white background)		
Alarm (number on grey background)		
Info (i)		
00	No warnings	
01	Board failure	Perform RESET. If the problem persists, replace the E145S.
04	Accessories power supply fault	Check the accessories connection for short circuits. Check the current drawn by the connected accessories and that maximum indicated load is not exceeded.
		Check the accessories protection fuse (on boards fitted with one). Perform RESET. If the problem persists, replace the control board.
06	Encoder 2 fault	Make sure that the encoder is connected properly. If the problem persists, replace the encoder.
16	Encoder 1 fault	Make sure that the encoder is connected properly. If the problem persists, replace the encoder.
20	FAIL-SAFE test failed	FAIL-SAFE test of a device failed. Check the connections, programming, and that the safety devices are working correctly.
22	Programming data corrupted	Programming data NOT valid or corrupted. Repeat BUS 2easy programming and registration.
24	Consecutive obstacles in closing	The programmed number of consecutive obstacles in closing has been reached. Remove the obstacle. If the problem persists, repeat the SETUP.
25	LOCK1 fault	LOCK1 fault. Check the connection. Remove the cause of the short circuit.
26	LOCK2 fault	LOCK2 fault. Check the connection. Remove the cause of the short circuit.

31	Consecutive obstacles in opening	The programmed number of consecutive obstacles in opening has been reached. Remove the obstacle. If the problem persists, repeat the SETUP.
32	Movement timeout	The movement is in timeout. Check the manual release. Check the presence of mechanical stops. If limit switches are installed, make sure that they activate correctly. If the problem persists, replace the board or motor.
35	BUS 2easy device fault/conflict	Check the addresses of the devices.
36	BUS 2easy short circuit/overload	Check the connections of the BUS 2easy devices that are connected and registered.
38	Programming parameters changed	Modified programming, NOT consistent with the SETUP. Restore the previous settings or carry out the SETUP procedure.
39	Set-up incorrect/missing	Perform SETUP.
41 (i)	Date/time missing	TIMER date/time missing. Replace the buffer battery BAT1 - CR2032, then reset the time and date on the board (from Simply Connect).
42 (i)	Partial open	Automation is in partial open mode.
44 (i)	Emergency input active	Check the emergency input.
48	Limit switch fault, leaf 1	Leaf1 limit switch fault. Check the connection of the limit switches.
49	Limit switch fault, leaf 2	Leaf2 limit switch fault. Check the connection of the limit switches.
60	Maintenance request	Ask the installer to carry out scheduled maintenance.
61	Obstacle detected Leaf1	An obstacle that prevents the leaf from moving has been detected. Remove the obstacle.
62	Obstacle detected Leaf2	An obstacle that prevents the leaf from moving has been detected. Remove the obstacle.
63	Intrusion attempt in progress	An attempt to open the leaf manually has been detected. Start a movement.
65	SETUP in progress	SETUP is in progress. The notification remains as long as the phase is in progress.
67 (i)	Low energy consumption mode	E145S is operating on battery, in SLEEP mode.

ENGLISH
Translation of the original instructions

76	Radio code memory full	The radio memory is full. Simply Connect allows you to delete any unused radio codes. Use an additional MiniDec/DECODER/RP module if necessary.
80	Safeties in opening disabled	The safety in opening devices has been disabled (via Simply Connect).
81	Safeties in closing disabled	The safety in closing devices has been disabled (via Simply Connect).
82	Opening sensitive edge disabled	The opening sensitive edges have been disabled (via Simply Connect).
83	Closing sensitive edges disabled	The closing sensitive edges have been disabled (via Simply Connect).
86 (i)	BUS 2easy disabled	BUS 2easy disabled (via Simply Connect).
87	BUS 2easy device registration in progress	A registration procedure is in progress.
90	Programming in progress	A registration procedure is in progress via Simply Connect.
99	Control board data deletion	All data on the E145S has been deleted.

11. MAINTENANCE

RISKS



PERSONAL PROTECTIVE EQUIPMENT



 Always shut off the power supply before performing any maintenance operations. If the disconnect switch is not in view, apply a warning sign stating "WARNING - Maintenance in Progress". Restore the power supply only after finishing any maintenance work and restoring the area to normal.

 Maintenance must be performed by the installer or a maintenance technician. Follow all safety recommendations and instructions given in this manual. Mark off the work site and prohibit access/transit. Do not leave the work site unattended.

The work area must be kept tidy and clear upon completing maintenance.

Before starting work, wait for any hot components to cool down.

Do not make any modifications to the original components.

FAAC S.p.A. shall bear no liability for damage or injury due to components that have been modified or otherwise tampered with.

 The warranty shall be forfeited in the event of tampering with components. Only use original FAAC spare parts.

11.1 ROUTINE MAINTENANCE

 11 lists the operations that should be performed on a regular basis on the E145S board in order to keep the automation working reliably and safely; these are given purely as a guideline and should not be considered exhaustive. The installer/machine manufacturer is responsible for drawing up the maintenance plan for the automation, supplementing this list or modifying the maintenance operations on the basis of the machine characteristics.

11 Scheduled maintenance

Operation	Frequency
Electronic equipment	
Check that the power supply and connecting cables and the cable glands are intact.	12
Check that the connectors and wiring are intact.	12
Check that there are no signs of overheating, burning etc. of electronic components.	12
Check that the earth connections are intact.	12
Check the operation of the circuit breaker and differential switch.	12
Control devices	
Check that the installed devices and radio controls are in good condition and that they operate correctly.	12
Sensitive edges	
Check condition, fastening and correct operation.	6
Photocells	
Check condition, fastening and correct operation.	6
Check the posts, ensuring that they are intact, correctly fastened and free of deformation etc.	6
Flashing light	
Check condition, fastening and correct operation.	12
Complete automation system	
Check that the automation system operates correctly, according to the set parameters, when using the various control devices.	12
Check that the gate moves correctly - smooth, regular and without abnormal noise.	12
Check that both the opening and closing speed are correct and that the stop positions and slow-downs provided for are respected.	12
Check that the manual release operates correctly: when the release mechanism is activated, it must only be possible to move the gate manually.	6
Check that the maximum force required for manual movement of the gate is below 225 N in residential areas and 390 N in industrial or commercial settings.	6
Check that the sensitive edges operate correctly when an obstacle is detected.	6
Check that each pair of photocells is working correctly.	6
Check that there is no optical/light interference between the pairs of photocells.	6
Check the force limitation curve (standards EN 12453 and EN 12445). For non-EU countries, if there are no specific local regulations, the force must be less than 150 N.	6

11.2 CYCLE COUNTER**READING THE CYCLES PERFORMED COUNTER**

Add together the readings of functions n_c (thousands) and n_d (tens) in ADVANCED programming.

RESETTING THE CYCLE COUNTER

In ADVANCED programming, with the function $F5 = n_0$, go to function n_c and press **+** and **-** for 5 s.

11.3 MAINTENANCE REQUESTED

It is possible to program the number of cycles after which maintenance is required.

When the automation reaches the set number of cycles, there is a pre-flashing of at least 8 s at each movement. The user should ask the installer to carry out maintenance.

1. In ADVANCED programming, function $F5$, select **Y** to enable the maintenance request.
2. In function n_c set the value in thousands using the **+** and **-** buttons.
3. In function n_d set the value in tens using the **+** and **-** buttons.
4. Exit and save the programming.

11.4 BUFFER BATTERY

The battery (model CR2032) is required if Simply Connect modules are installed.

It should be replaced with the power disconnected.

Insert the batteries in the direction shown.



FAAC S.p.A. Soc. Unipersonale
Via Calari, 10 - 40069 Zola Predosa BOLOGNA - ITALY
Tel. +39 051 61724 - Fax +39 051 09 57 820
www.faac.it - www.faacgroup.com