

E844 3PH

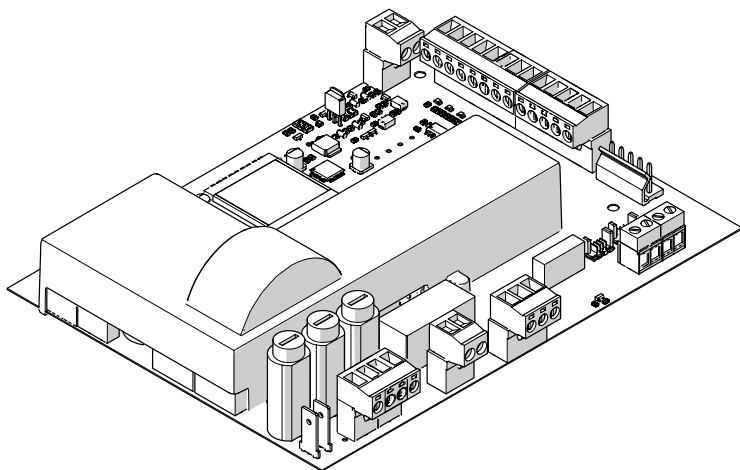

FAAC



FAAC S.p.A. Soc. Unipersonale
Via Calari, 10 - 40069 Zola Predosa BOLOGNA - ITALY
Tel. +39 051 61724 - Fax +39 051 09 57 820
www.faac.it - www.faacgroup.com

© Copyright FAAC S.p.A. dal 2019. Tutti i diritti riservati.

Nessuna parte di questo manuale può essere riprodotta, archiviata, distribuita a terzi né altrimenti copiata, in qualsiasi formato e con qualsiasi mezzo, sia esso elettronico, meccanico o tramite fotocopia, senza il preventivo consenso scritto di FAAC S.p.A.

Tutti i nomi e i marchi citati sono di proprietà dei rispettivi fabbricanti.

I clienti possono effettuare copie per esclusivo utilizzo proprio.

Questo manuale è stato pubblicato nel 2019.

© Copyright FAAC S.p.A. from 2019. All rights reserved.

No part of this manual may be reproduced, archived, distributed to third parties nor copied in any other way, in any format and with any means, be it electronic, mechanical or by photocopying, without prior written authorisation by FAAC S.p.A.

All names and trademarks mentioned are the property of their respective manufacturers.

Customers may make copies exclusively for their own use.

This manual was published in 2019.

© Copyright FAAC S.p.A. depuis 2019. Tous droits réservés.

Aucune partie de ce manuel ne peut être reproduite, archivée ou distribuée à des tiers ni copiée, sous tout format et avec tout moyen, qu'il soit électronique, mécanique ou par photocopie, sans le consentement écrit préalable de FAAC S.p.A.

Tous les noms et les marques cités sont la propriété de leurs fabricants respectifs.

Les clients peuvent faire des copies pour leur usage exclusif.

Ce manuel a été publié en 2019.

© Copyright FAAC S.p.A. ab dem 2019. Alle Rechte vorbehalten.

Kein Teil dieses Handbuchs darf reproduziert, gespeichert, an Dritte weitergegeben oder sonst auf eine beliebige Art in einem beliebigen Format und mit beliebigen Mitteln kopiert werden, weder mit elektronischen, noch mechanischen oder durch Fotokopieren, ohne die Genehmigung von FAAC S.p.A.

Alle erwähnten Namen und Marken sind Eigentum der jeweiligen Hersteller.

Die Kunden dürfen nur für den Eigengebrauch Kopien anfertigen.

Dieses Handbuch wurde 2019 veröffentlicht.

© Copyright FAAC S.p.A. del 2019. Todos los derechos están reservados.

No puede reproducirse, archivar, distribuirse a terceros ni copiarse de ningún modo, ninguna parte de este manual, con medios mecánicos o mediante fotocopia, sin el permiso previo por escrito de FAAC S.p.A.

Todos los nombres y las marcas citadas son de propiedad de los respectivos fabricantes.

Los clientes pueden realizar copias para su uso exclusivo.

Este manual se ha publicado en 2019.

© Copyright FAAC S.p.A. van 2019. Alle rechten voorbehouden.

Niets uit deze handleiding mag gereproduceerd, gearchiveerd, aan derden openbaar gemaakt of op andere wijze gekopieerd worden, in om het even welke vorm en met geen enkel middel, noch elektronisch, mechanisch of via fotokopiëren, zonder schriftelijke toestemming vooraf van FAAC S.p.A.

Alle vermelde namen en merken zijn eigendom van de respectievelijke fabrikanten.

De klanten mogen kopieën maken die enkel voor eigen gebruik bestemd zijn.

De handleiding werd in 2019 gepubliceerd.

CONTENTS

EU Declaration of conformity 2

1. INTRODUCTION TO THIS INSTRUCTION MANUAL 2

 1.1 Meaning of the symbols used 3

2. SAFETY RECOMMENDATIONS 4

 2.1 Installer safety 4

 2.2 Storage 4

 2.3 Waste disposal 4

3. E844 3PH 5

 3.1 Intended use 5

 3.2 Limitations of use 5

 3.3 Unauthorised use 5

 3.4 Product identification 5

 3.5 Technical specifications 5

4. INSTALLATION REQUIREMENTS 6

 4.1 Electrical system 6

5. INSTALLATION 6

 5.1 Tools required 6

 5.2 Components 7

 5.3 Connections 8

 Control devices 8

 Accessories power supply 9

 Outputs 9

 Failsafe 9

 Limit switches 9

 Flashing light 9

 BUS 2easy devices 10

 Radio receiver/decoder board 10

 Motor 10

 Connecting the earth 10

 Mains power supply 10

6. SET-UP 11

 6.1 Programming 11

 6.2 Operating logics 13

 6.3 Setup 14

 6.4 Restore the default values 14

7. PUTTING INTO SERVICE 14

 7.1 Final checks 14

 7.2 Close the enclosure 14

 7.3 Final operations 14

8. ACCESSORIES 15

 8.1 Closing photocells 15

 8.2 Sensitive edges 15

 8.3 BUS 2easy devices 16

 Connection 16

 BUS 2easy photocells 16

 BUS 2easy control devices 16

 BUS 2easy device registration 17

9. DIAGNOSTICS 18

 9.1 Firmware version 18

 9.2 LEDs check 18

 9.3 Automated system status 18

 9.4 Alarms/Errors 18

10. MAINTENANCE 19

 10.1 Routine maintenance 19

TABLES

 **1** Symbols: notes and warnings on the instructions 3

 **2** Symbols: personal protective equipment 3

 **3** Symbols: safety signs and symbols (EN ISO 7010) 3

 **4** Technical data E844 3PH 5

 **5** Assigning an address to the photocells 16

 **6** Addressing control devices 16

 **7** Status of the LEDs 18

 **8** Automated system status 18

 **9** Alarms/Errors 18

 **10** Scheduled maintenance 19

EU DECLARATION OF CONFORMITY

The Manufacturer

Company name: FAAC S.p.A. Soc. Unipersonale

Address: Via Calari, 10 - 40069 Zola Predosa BOLOGNA - ITALY

hereby declares under its own exclusive liability that the following product:

Description: electronic equipment

Model: E844 3PH

complies with the following applicable EU legislations:

- 2014/30/EU
- 2014/35/EU
- 2011/65/UE

Furthermore, the following harmonised standards have been applied:

- EN 60335-1:2012 + A1:2014
- EN 61000-6-2:2005
- EN 61000-6-3:2007 + A1:2011

Other standards (applicable parts):

- EN 60335-2-103:2015
- EN 13849-1:2015 CAT 2 PL "C"

Bologna, 01-10-2019

CEO
A. Marcellan



1. INTRODUCTION TO THIS INSTRUCTION MANUAL

This manual provides the correct procedures and requirements for installing E844 3PH and maintaining it in a safe condition.

When drafting the manual, the results of the risk assessment conducted by FAAC S.p.A. on the entire product life cycle have been taken into account in order to implement effective risk reduction measures. The following stages of the life cycle of the product have been considered:

- Delivery/handling
- Assembly and installation
- Set-up and commissioning
- Operation
- Maintenance/troubleshooting
- Disposal at the end of the product's life cycle

Risks arising from installation and using the product have been taken into consideration; these include:

- Risks for the installation/maintenance technician (technical personnel)
- Risks for the user of the automation system
- Risks to product integrity (damage)

In Europe, the automation of a gate falls under the Machinery Directive 2006/42/EC and the corresponding harmonised standards. Anyone automating a gate (new or existing) is classified as the Manufacturer of the Machine. They are therefore required by law, among other things, to carry out a risk analysis of the machine (automatic gate in its entirety) and take protective measures to fulfil the essential safety requirements specified in Annex I of the Machinery Directive.

FAAC S.p.A. recommends that you always comply with the EN 12453 standard and in particular that you adopt the safety criteria and devices indicated, without exception, including the dead-man function.

This manual also contains general information and guidelines, which are purely illustrative and not exhaustive, in order to facilitate the activities carried out by the Manufacturer of the Machine in all respects with regard to carrying out the risk analysis and drafting the instructions for use and maintenance of the machine. It should be clearly understood that FAAC S.p.A. accepts no liability for the reliability and/ or completeness of the above instructions. As such, the manufacturer of the machine must carry out all the activities required by the Machinery Directive and the corresponding harmonised standards on the basis of the actual condition of the locations and structures where the product E844 3PH will be installed, prior to commissioning the machine. These activities include the analysis of all the risks associated with the machine and subsequent implementation of all safety measures intended to fulfil the essential safety requirements.

This manual contains references to European standards. The automation of a gate must fully comply with any laws, standards and regulations applicable in the country where installation will take place.

 Unless otherwise specified, the measurements provided in the instructions are in mm.

1.1 MEANING OF THE SYMBOLS USED

	1 Symbols: notes and warnings on the instructions
	WARNING ELECTRIC SHOCK HAZARD - The procedure or step described must be carried out following the instructions provided and according to the applicable safety regulations
	WARNING, PERSONAL INJURY HAZARD OR RISK OF DAMAGE TO COMPONENTS - The procedure or step described must be carried out following the instructions provided and according to the applicable safety regulations.
	WARNING - Details and specifications that must be complied with in order to ensure that the system operates correctly.
	RECYCLING AND DISPOSAL - The materials used in manufacturing, the batteries and any electronic components must not be sent to landfill. They must be taken to authorised recycling and disposal centres
	FIGURE E.g.:  1-3 see Figure 1 - detail 3.
	TABLE E.g.:  1 see Table 1.
§	CHAPTER/SECTION E.g.: §1.1 see section 1.1.
○	LED off
●	LED on
*	LED flashing
* (with lightning bolt)	LED flashing quickly

 **2** Symbols: personal protective equipment Personal protective equipment must be worn to protect against hazards (e.g. crushing, cutting, shearing etc.): |

Obligation to wear work gloves

Obligation to wear safety footwear

	3 Symbols: safety signs and symbols (EN ISO 7010)
	GENERIC HAZARD Personal injury hazard or risk of damage to components
	ELECTROCUTION HAZARD Risk of electric shock from live parts
	BURNING OR SCALDING HAZARD Risk of burns or scalding due to the presence of high-temperature parts
	RISK OF CUTTING/AMPUTATION/PUNCTURE - Cutting hazard due to the presence of sharp components or the use of pointed/sharp tools
	RISK OF CRUSHING HANDS - Risk of crushing hands due to moving parts
	RISK OF SHEARING - Risk of shearing due to moving parts
	RISK OF IMPACT/CRUSHING/SHEARING - Risk of impact, crushing or shearing due to moving parts

2. SAFETY RECOMMENDATIONS

This product has been placed on the market as a control system for gearmotors and sliding gates and therefore must not be put into service until the machine into which it has been incorporated has been declared compliant with the Machinery Directive 2006/42/EC by its manufacturer.



Incorrect installation and/or incorrect use of the product might cause serious harm to people. Read the instructions before using the product and comply with them. Keep these instructions for future reference. Perform installation and other activities adhering to the sequences provided in the instructions manual. Always comply with all the requirements contained in the instructions and warning tables at the beginning of the paragraphs. Always comply with the safety recommendations.

Only the installer and/or maintenance technician is/are authorised to carry out work on the components of the automation. Do not make any modifications to the original components.

Cordon off the work site (even temporarily) and prohibit access/transit. For EC countries, comply with the national legislation that transposes the European Directive on Construction sites 92/57/EC.

The installer is responsible for the installation/testing of the automation and for preparing the system Register.

The installer must demonstrate or declare that he/she has the technical-professional competency to carry out the installation, testing and maintenance in accordance with the requirements of these instructions.

2.1 INSTALLER SAFETY

Installation activities require special work conditions to reduce to the minimum the risks of accidents and serious damage. Furthermore, the suitable precautions must be taken to prevent risks of injury to persons or damage.



The installer must be in good physical and mental condition, aware of and responsible for the hazards that may be generated when using the product. The work area must be kept tidy and must not be left unattended. Do not wear clothes or accessories (scarves, bracelets, etc.) that may get caught in moving parts. Always wear the personal protective equipment recommended for the type of activity to be carried out. The required level of workplace lighting must be equal to at least 200 lux.

Operate CE marked machinery and equipment in compliance with the manufacturer's instructions. Use work instruments in good conditions.

Use the transport and lifting equipment recommended in the instructions manual.

Use safety-compliant portable ladders of adequate size, fitted with anti-slip devices at the top and bottom, equipped with retainer hooks.

2.2 STORAGE

STORAGE

Store the product in its original packaging, in closed and dry premises, protected from the sun and free from dust and aggressive substances. Protect from mechanical stress. If stored for more than 3 months, regularly check the condition of the components and the packaging.

- Storage temperature: 5°C to 30°C.
- Percentage of humidity: 30% to 70%.

2.3 WASTE DISPOSAL



The packaging materials (plastic, polystyrene etc.) must not be left within reach of children as they are potential sources of danger.

Discard the packaging after use in the appropriate containers in compliance with waste disposal regulations.

After having dismantled the product, dispose of it in compliance with the current waste disposal regulations.



Components and structural materials, batteries and electronic components must not be disposed of together with household waste. They must be taken to authorised disposal and recycling centres.

3. E844 3PH

3.1 INTENDED USE

The FAAC E844 3PH electronic board has been designed to control FAAC 844 R 3PH and 884 MC 3PH gearmotors for horizontal movement sliding gates intended for installation in areas that are accessible to people, the main purpose of which is to provide safe access for goods or vehicles accompanied or driven by people in industrial, commercial or residential settings.



Any other use that is not expressly specified in these instructions is prohibited and could affect the integrity of the product and/or represent a source of danger.

3.2 LIMITATIONS OF USE

- Using the product in any configuration other than that intended by FAAC S.p.A. is prohibited. It is prohibited to modify any of the product's components

3.3 UNAUTHORISED USE

- Do not use on motors or devices that are intended for purposes other than operating gates.
- Uses other than the intended use are prohibited.
- It is prohibited to install the E844 3PH on smoke and/or fire doors.
- It is prohibited to install the E844 3PH in environments in which there is a risk of explosion and/or fire: the presence of flammable gases or fumes is a serious safety hazard (the product is not 94/9/EC ATEX certified).
- It is prohibited to power the system with energy sources other than those specified.
- It is prohibited to integrate commercial systems and/or equipment other than those specified, or use them for purposes not envisaged and authorised by the corresponding manufacturers.
- It is prohibited to use and/or install accessories which have not been specifically authorised by FAAC S.p.A.
- It is prohibited to use the E844 3PH in the presence of faults which could compromise safety.
- Do not allow water jets of any type or size to come into direct contact with the E844 3PH.
- Do not expose the E844 3PH to corrosive chemical or environmental agents.

3.4 PRODUCT IDENTIFICATION

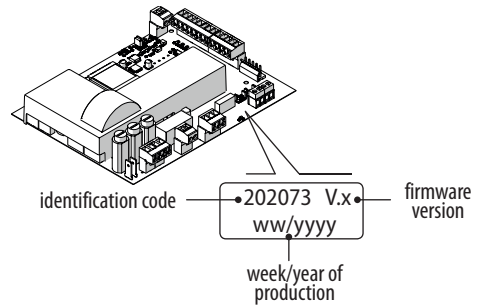

3.5 TECHNICAL SPECIFICATIONS

E844 3PH is an electronic board designed to control a single motor having a maximum power of 1.5 kW and a 400V three phase + Neutral power supply.

Display The board functions are programmed via a LCD display and 3 buttons.

Limit switch In order to operate correctly, the opening and closing limit switches of the gearmotor have to be connected to the E844 3PH board .

End of travel slowdown The E844 3PH can adjust the slowdown points close to the open and closed positions, in order to limit inertial forces and reduce the vibrations of the gate when it is stopping (only in combination with the 844 R 3PH).

Bus 2easy It is possible to connect FAAC Bus 2easy devices (photocells and control devices) to the E844 3PH board.

Encoder The E844 3PH is fitted with a sensor for reading the encoder disc in the 844 R 3PH gearmotors, via which it is able to detect the presence of an obstacle (only with board installed on the operator). The sensitivity of the obstacle detection system can be adjusted.

4 Technical data E844 3PH

Power supply voltage	380-415 V~ 3PH + N 50/60 Hz
Max power	3 W
Max. motor power	1500 W
Max. accessories load	24 V== 500 mA Bus 2easy 500 mA
Max. flashing light load	230 V~ 60 W max
Ambient operating temperature	-20 °C to +55 °C
Stopping space with 844 R 3PH	8 cm
Stopping space with 884 MC 3PH	8 cm

4. INSTALLATION REQUIREMENTS

4.1 ELECTRICAL SYSTEM



Always shut off the power supply before performing any work. If the disconnect switch is not in view, apply a warning sign stating "WARNING - Maintenance in Progress".



The electrical system must comply with applicable legislation in the country of installation. Use components and materials with CE marking which are compliant with the Low Voltage Directive 2014/35/EU and EMC Directive 2014/30/EU.

The power supply line for the automation must be fitted with a multi-pole circuit breaker, with a suitable tripping threshold, a contact opening distance of at least 3 mm and a breaking capacity that complies with current regulations.

The power supply for the automation must be fitted with a 30 mA differential switch.

The metal parts of the structure must be earthed. Check that the protective earthing system complies with applicable regulations in the country of installation.

The electrical cables of the automation system must be of a size and insulation class that is compliant with current legislation and laid in appropriate rigid or flexible conduits, either above or below ground. Use separate conduits for the power supply and the 12-24 V control devices / accessories cables.

Check buried cable plans to ensure that there are no other electrical cables in proximity to the planned digging/drilling locations to prevent the risk of electrocution.

Check that there are no pipes in the vicinity as well. The external electronic board must be housed in an enclosure that has a minimum IP 44 protection rating and fitted with a lock or another type of device to prevent access by unauthorised persons. The enclosure must be located in an accessible and non-hazardous area and at least 30 cm from the ground. The cable outlets must face downwards.

The conduit fittings and the cable glands must prevent the entry of moisture, insects and small animals. Protect extension connections using junction boxes with an IP 67 protection rating or higher.

The overall length of the BUS cables must not exceed 100 m.

It is recommended to install a flashing light in a visible position to indicate when it is moving.

The control accessories must be positioned in areas that are always accessible and not dangerous for the user. It is recommended to position the control accessories within the field of view of the automation. This is mandatory in the case of hold-to-run controls.

The hold-to-run controls in the dead-man mode of operation, must comply with standard EN 60947-5-1. If an emergency stop button has been installed, it must be EN13850 compliant.

Comply with the following heights from the ground:

- control accessories = minimum 150 cm
- emergency buttons = maximum 120 cm

If the manual controls are intended to be used by disabled or infirm persons, highlight them with suitable pictograms and make sure that these users are able to access them.

5. INSTALLATION

RISKS



PERSONAL PROTECTIVE EQUIPMENT



ALWAYS DISCONNECT THE POWER SUPPLY before working on the board.

If the disconnect switch is not in view, apply a warning sign stating "WARNING - Maintenance in Progress". Turn the power on only after having made all the electrical connections and carried out the preliminary start-up checks.



The E844 board is fitted with a plastic cover that safeguards against electrocution by contact with live parts of the circuit. The cover should never be removed.

5.1 TOOLS REQUIRED



Use appropriate tools and equipment in working environments which comply with applicable legislation.

5.2 COMPONENTS

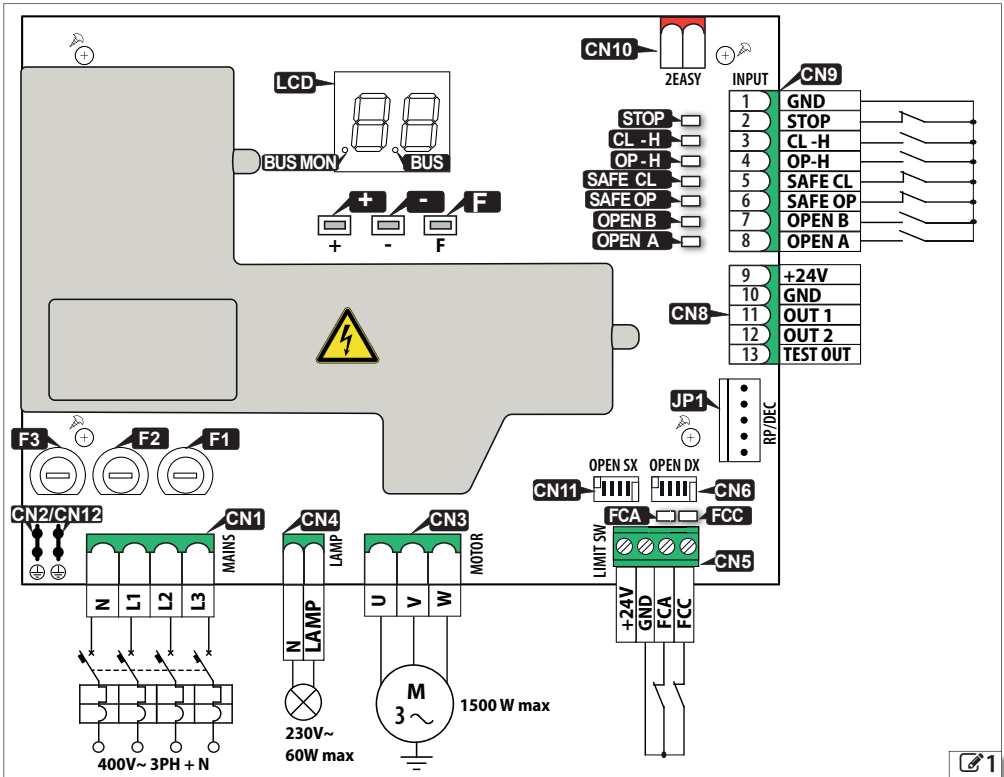

KEY:	
CN1	Removable terminal board for the mains power supply
CN2 / CN12	Faston connectors for earth connection
CN3	Removable terminal board for connecting the motor
CN4	Removable terminal board for connecting the flashing light
CN5	Terminal board for connecting limit switch
CN6 / CN11	Quick insertion connectors for inductive limit switch
CN8	Removable terminal board for outputs and accessories power supply
CN9	Removable terminal board for connecting control devices
CN10	Removable terminal board for connecting Bus 2Easy devices
JP1	Connector (5 pin) for FAAC radio/decoder boards
LCD	Programming display
F1 F2 F3	Mains power supply fuses (8AT)
+ - F	Programming buttons

Status LEDs <input type="checkbox"/> :	
STOP	Stop command
CL - H	Priority close command
OP - H	Priority open command
SAFE CL	Closing safety device
SAFE OP	Opening safety device
OPEN B	Partial motion command
OPEN A	Total motion command
FCA	Opening limit switch
FCC	Closing limit switch
BUS	Bus 2Easy devices
BUS MON	Bus 2Easy line

ENGLISH
Translation of the original instructions

5.3 CONNECTIONS

CONTROL DEVICES

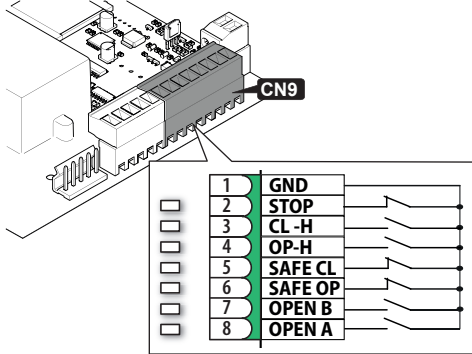

Connect the devices to terminal board CN9.



Multiple NO contacts on same input must be connected in parallel.
Multiple NC contacts on same input must be connected in series.

1 GND Common contacts

(Stop command)

2 STOP NC contact, connect a push-button or another type of pulse generator which, by opening a contact, causes the automation to stop.



If the input is not used, bridge it with GND

(PRIORITY close command)

3 CL-H NO contact, connect a push-button that, as long as it keeps a contact closed, commands the closing of the gate in 'hold-to-run' mode without any monitoring of safety devices.



Activation must be intentional and the gate must be visible

(PRIORITY open command)

4 OP-H NO contact, connect a push-button that, as long as it keeps a contact closed, commands the opening of the gate in 'hold-to-run' mode without any monitoring of safety devices.



Activation must be intentional and the gate must be visible

(Safety in closing active)

Connect a sensitive edge or another device that, when activated during closing, causes the gate to reverse partially or completely.

This input can be configured by setting programming function S_C to connect:

- 5 SAFE CL** - sensitive edges with NC contact ($S_C = nC$)
 - resistive sensitive edges 8.2 k Ω ($S_C = rE$) - default-
 - photocells ($S_C = PH$)
 Reverse after a sensitive edge has been activated can be configured by setting programming function i^P :
 - partial reverse of 3 s ($i^P = \text{U}$)
 - complete reverse ($i^P = nO$)

(Safety in opening active)

Connect a sensitive edge or another device that, when activated during opening, causes the gate to reverse partially or completely.

This input can be configured by setting programming function S_O to connect:

- 6 SAFE OP** - sensitive edges with NC contact ($S_O = nC$)
 - resistive sensitive edges 8.2 k Ω ($S_O = rE$) - default-
 Reverse can be configured by setting programming function i^P :
 - partial reverse of 3 s ($i^P = \text{U}$)
 - complete reverse ($i^P = nO$)

(PARTIAL motion command)

NO contact, connect a push-button or another type of pulse generator which, by closing a contact, commands the partial opening of the gate.

7 OPEN B

The partial opening width is set in programming function $P\Box$ (from 1 to 20 s).

The effect that subsequent pulses have depends on the operating logic set in programming function L_O .

(TOTAL motion command)

NO contact, connect a push-button or another type of pulse generator which, by closing a contact, commands the total opening of the gate.

8 OPEN A

The effect that subsequent pulses have depends on the operating logic set in programming function L_O .



By default, the SAFE CL and SAFE OP inputs are configured to connect resistive type sensitive edges. If one or both are not used, set function S_O and/or $S_C = nC$ and bridge with the common contacts (GND terminal), otherwise they would be active.

ACCESSORIES POWER SUPPLY

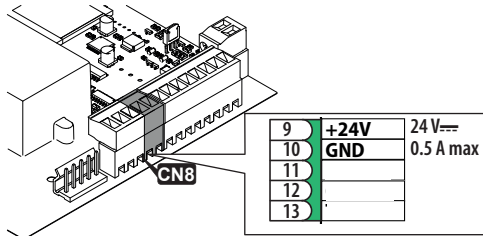

The E844 3PH supplies 24 V $\overline{\text{=}}$ and is short-circuit protected with a maximum current of 0.5 A for connected accessories.

OUTPUTS

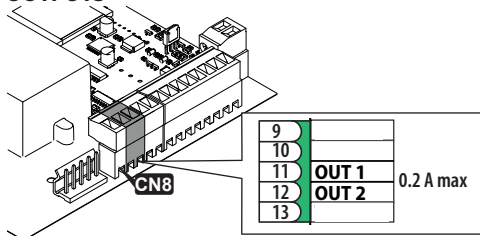

The E844 3PH has two Open Collector outputs that are activated according to programming functions $\alpha 1$ and $\alpha 2$.

OUT active	OUT not active
0V $\overline{\text{=}}$	open circuit

Do not exceed the maximum load of 0.2 A for each output.

FAILSAFE

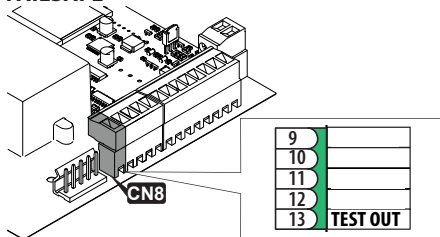

Failsafe is a functional test that is carried out before a movement to check that the devices connected to the SAFE inputs are working correctly.

If the test fails, the board prevents the automation from moving (error $\square 5$).

To enable/disable the failsafe, see programming function F5.

LIMIT SWITCHES

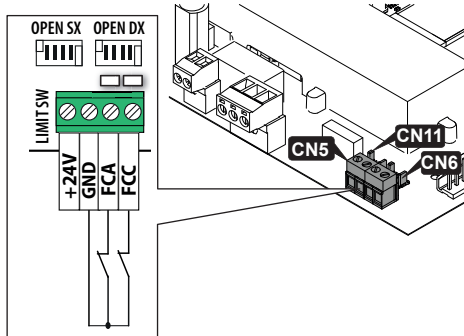

In order for to operate correctly, the E844 3PH board has to be connected to the opening and closing limit switches.

For the 844 R 3PH inductive sensor, use the quick insertion connector CN6 (open towards the right) or CN11 (open towards the left). The opening direction is determined by looking at the gate from the side on which the gearmotor is installed.

For the 884 MC 3PH sensor, use terminal board CN5:

FCA	(OPENING limit switch) NC contact
FCC	(CLOSING limit switch) NC contact
GND	Common contacts
+24V	Accessories power

FLASHING LIGHT

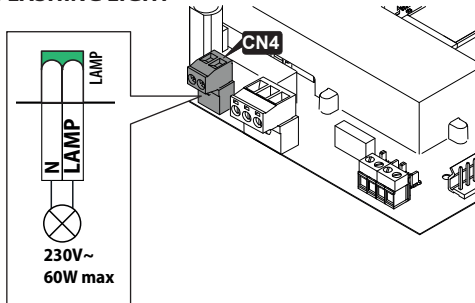

The flashing light indicates that the gate is moving and must be installed in a position that is visible from both sides of the gate.

Connect the flashing light (230 V \sim , max 60 W model), to terminal board CN4.

Pre-flashing of 3 s before movement can be enabled via programming function PF.

BUS 2EASY DEVICES

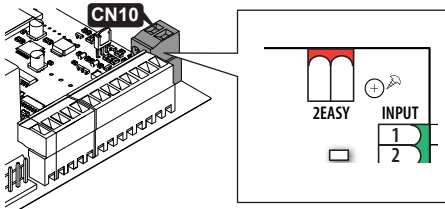

i If no BUS 2easy devices are used, leave the terminals free.

For connecting and assigning addresses see § Accessories. Do not exceed the maximum load of 0.5 A.

RADIO RECEIVER/DECODER BOARD

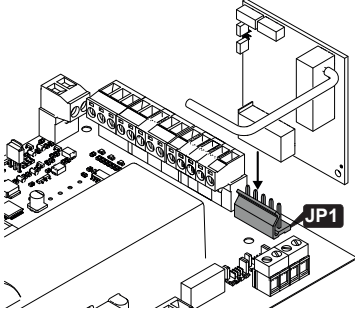

The quick insertion connector JP1 is specifically for 5-pin FAAC radio or decoder boards. It is a polarised type of connector.

i If a FAAC model RP receiver is used, it is recommended to install the appropriate external antenna in order to obtain a sufficient range.

MOTOR

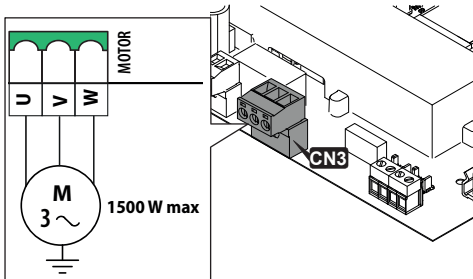

Connect the three phase wires of the electric motor.

! The gearmotor **MUST** be connected to the earth of the electrical system.

CONNECTING THE EARTH

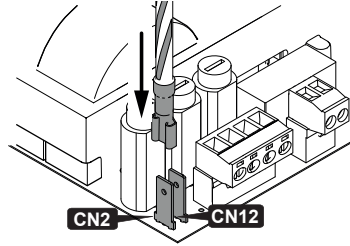

To connect the earth of the board to the earth plug on the gearmotor, insert the cable with the crimped faston connector into CN2 or CN12. The second faston connector can be used to connect the ground of the electrical system.

! The gearmotor **MUST** be connected to the earth of the electrical system.

MAINS POWER SUPPLY

! Carry out the following operations with the power supply disconnected.

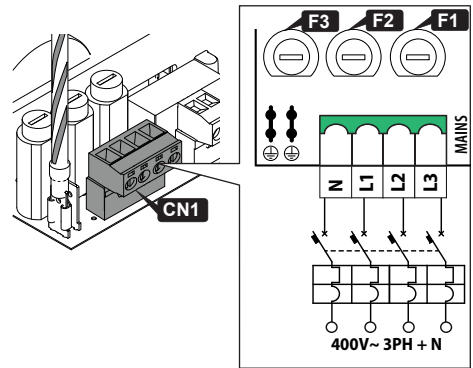

Connect the 3 Phase wires (400 V~) and the Neutral of the mains power supply using cables having a minimum diameter of 2.5 mm.

The board has an 8AT fuse for each phase.

6. SET-UP

RISKS



PERSONAL PROTECTIVE EQUIPMENT



During operation, there is a risk of fingers and hands being trapped between the rack, pinion and gearmotor.

Carry out the steps, referring to the relative sections for details.

1. Turn on power to the board.
2. Check the direction of rotation of the motor:
 - release the gearmotor, move the gate manually to its half-travel position and then re-lock it
 - activate the open command OP-H temporarily and make sure that the gate moves in the opening direction
 - if the gate moves in the closing direction, temporarily disconnect the power supply and invert two phases of the motor (on connector CN3)
3. Release the gearmotor, move the gate manually to its closed position and then re-lock it (make sure that the FCC led switches off in this position and that $\square\square$) appears on the display.
4. Set the type of gearmotor connected: function dF in programming.
5. Only for 844 R 3PH: program the pre-limit switch decelerations in function rP in programming. The pre-limit switch deceleration reduces the inertia of the gate, allowing the impact forces to fall within the limits indicated in the standard.
6. Carry out the learning procedure for any BUS 2easy devices: function BJ in programming.
7. Set the functions S_o (safety in opening) and S_c (safety in closing) according to the type of devices connected.
8. Carry out the learning procedure for the work times (SETUP): function EL in programming.



In order for the SETUP procedure to be carried out, the CLOSED limit switch must be engaged by the gate.

9. If the board is installed on gearmotor 844 R 3PH, regulate the obstacle detection sensitivity: function EC in programming.
10. Complete the programming according to the required operating characteristics.
11. Make sure that the automation system is working properly with all the devices installed.

6.1 PROGRAMMING

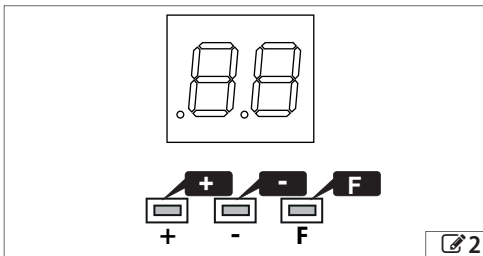

■ Accessing the programming menu

- Press and hold button **F**: the first function dF appears on the display. The function is displayed as long as the **F** button remains pressed.
- Release button **F**: the display shows the value of the function.

■ Modifying the settings

- When the display indicates the value of the function, press the + or - button to modify it.
- Press button **F** to go to the next function. The function is displayed as long as button F remains pressed.



The changes are saved when you exit from programming mode.

■ Exiting programming mode

- Scroll through the menu until you reach the S_c function and release the button. The display reverts to the automation status view. Alternatively, press buttons **F** and - simultaneously at any time during programming.

Function		default
df	Type of gearmotor	00
	00 844 R 3PH 01 884 MC 3PH	
Lo	Operating logic	EP
	E Semi-automatic	
	EP Semi-automatic step by step	
	A Automatic	
	AP Automatic step by step	
	S Automatic Safety	
	b Semi-automatic B c Hold-to-run	
PA	Pause time	30
	carried out in the automatic logics From 0 s to 9.5 min ; adjustment in steps of 1 s from 0 to 59, then in steps of 10 s	
Pb	Partial pause time	30
	carried out in the automatic logics following a partial opening From 0 s to 9.5 min ; adjustment in steps of 1 s from 0 to 59, then in steps of 10 s	
FS	Failsafe	no
	no disabled	
	01 enabled only on SAFE OP	
	02 enabled only on SAFE CL 03 enabled on SAFE OP and SAFE CL	
EC	Encoder obstacle detection sensitivity	00
	(available only for board installed on 844 R 3PH)	
	00 Obstacle detection not enabled 01 (maximum sensitivity) ... 99 (minimum sensitivity)	
SS	SOFT-START	y
	acceleration ramp at each start (available only for 844 R 3PH)	
	y enabled no not enabled	
rP	Pre-limit switch deceleration	00
	as a percentage of the travel of the gate that was memorised during learning procedure for the work times (available only for 844 R 3PH)	
	00 no slowdown 05...30 %	
PO	Partial opening width	05
	01...20 in steps of 1 s	

Function		default
o1	Output OUT1 configuration	00
	the output is activated according to selected function	
	00 Always active	
	02 LED	
	03 Courtesy Light	
	04 Error	
	05 Status OPEN/IN PAUSE	
	06 Status CLOSED	
	07 Status MOVING	
	08 Status EMERGENCY	
	09 Status OPENING	
	10 Status CLOSING	
	12 Safety device active 13 TRAFFIC LIGHT CONTROL (active when opening/in pause/open)	
t1	OUT1 timing	02
	only for the Courtesy Light 00...99 min	
o2	Output OUT2 configuration	00
	the output is activated according to selected function	
	00 Always active	
	02 LED	
	03 Courtesy Light	
	04 Error	
	05 Status OPEN/IN PAUSE	
	06 Status CLOSED	
	07 Status MOVING	
	08 Status EMERGENCY	
	09 Status OPENING	
	10 Status CLOSING	
	12 Safety device active 13 TRAFFIC LIGHT CONTROL (active when opening/in pause/open)	
t2	OUT2 timing	02
	only for the Courtesy Light 00...99 min	
nc	Cycle counter (x1000)	00
	00...99 in steps of 1000	
nd	Cycle counter (x10)	00
	00...99 in steps of 10	

Function		default
So	SAFE OP input configuration	
	nc	Sensitive edge with NC contact
	rE	Resistive sensitive edge 8.2 kΩ
Sc	SAFE CL input configuration	
	nc	Sensitive edge with NC contact
	rE	Resistive sensitive edge 8.2 kΩ
iP	Sensitive edge reverse mode	
	y	Partial reverse 3 s
bu	Learn BUS 2easy devices	
	See the relative section	
PF	Pre-flashing for 3 s on the LAMP output	
	no	No pre-flashing
	OC	Pre-flashing before every movement
EL	Learn work time (SETUP)	
	<p>In order for the learning procedure to be carried out, the CLOSED limit switch must be engaged by the gate.</p> <p>Press the + and - buttons simultaneously to start the learning function.</p> <p>If no button is pressed within 2 minutes, you automatically exit from programming mode.</p>	
St	Exit from programming mode and display the status of the automation:	
	00	CLOSED
	01	OPEN
	03	STOPPED
	04	IN PAUSE
	05	OPENING
	06	CLOSING
	09	PRE-FLASHING and then OPENS
	10	PRE-FLASHING and then CLOSES

6.2 OPERATING LOGICS

The STOP command has priority over all other commands and stops the automation in all the logics. In all the logics, except B and C, the OPEN B command partially opens the gate if it is closed, in all other states it has the same function as the OPEN A command. In logics B and C (separate opening and closing command logics), OPEN B only closes the gate.

■ A AUTOMATIC

This logic only requires the OPEN command to be used. OPEN if the automation is closed, causes it to open. The automation closes automatically after the pause time has elapsed.

OPEN during pause, resets the pause time.

OPEN during opening, is ignored.

OPEN during closing, causes it to reopen.

If the closing photocells are triggered during the pause time, they reset the pause time.

■ AP AUTOMATIC STEP-BY-STEP

This logic only requires the OPEN command to be used. OPEN if the automation is closed, causes it to open. The automation closes automatically after the pause time has elapsed.

OPEN during pause, stops it and the next OPEN command closes it.

OPEN during opening, stops it and the next OPEN command closes it.

OPEN during closing, causes it to reopen.

If the closing photocells are triggered during the pause time, they reset the pause time.

■ S AUTOMATIC SAFETY

This logic only requires the OPEN command to be used. OPEN if the automation is closed, causes it to open. The automation closes automatically after the pause time has elapsed.

OPEN during the pause, causes it to close.

OPEN during opening, causes it to close.

OPEN during closing, causes it to reopen.

If the closing photocells are triggered during the pause time, they close the automation 3 seconds after they have been released.

■ E SEMI-AUTOMATIC

This logic only requires the OPEN command to be used.

OPEN if the automation is closed, causes it to open.

OPEN if the automation is open, causes it to close.

OPEN during opening, stops it and the next OPEN command closes it.

OPEN during closing, causes it to reopen.

■ **EP SEMI-AUTOMATIC STEP-BY-STEP**

This logic only requires the OPEN command to be used.
 OPEN if the automation is closed, causes it to open.
 OPEN if the automation is open, causes it to close.
 OPEN during opening or closing, stops it and the next OPEN command reverses the direction.

■ **C HOLD-TO-RUN**

This logic requires the maintained OPEN A (open) and OPEN B (close) commands to be used.



- In the Hold-to-run mode:
- the control must be activated intentionally and the gate must be visible
 - the SAFE inputs stop the movement immediately

Maintained OPEN A opens the automation.
 Maintained OPEN B closes the automation.

■ **b SEMI-AUTOMATIC b**

This logic requires the OPEN A (open) and OPEN B (close) commands to be used.
 OPEN A if the automation is closed, causes it to open.
 OPEN A during opening, has no effect.
 OPEN A during closing, causes it to reopen.
 OPEN B if the automation is open, causes it to close.
 OPEN B during closing, has no effect.
 OPEN B during opening, causes it to close.
 Movement stops if the closing photocells are triggered.

6.3 SETUP

The SETUP must be carried out when the board is first installed, each time the board is replaced or installed in another system, or if the characteristics of the gate change.

Set-up procedure:

- The gate MUST engage the CLOSED limit switch (make sure that the FCC LED is off).
- Select the **b** function in programming.
- Press and hold down the + and - buttons simultaneously, the gate starts to open and **SI** appears on the display.
- SETUP is complete when the open limit switch is reached.

6.4 RESTORE THE DEFAULT VALUES

To restore the default values for all the functions:

- Press and hold down the +, -, **F** buttons simultaneously for 10 seconds
- Release the buttons when the separator point between the two digits on the display flashes

7. PUTTING INTO SERVICE

7.1 FINAL CHECKS

1. Make sure that the forces generated by the gate are within the limits permitted by the current regulations. Use an impact force tester in accordance with EN 12453. For non-EU countries, of there are no specific local regulations, the force must be less than 150 N. If necessary, make any adjustments that may be needed by referring also to the gearmotor instructions.
2. Carry out a complete functional test of the automation and all the installed devices.
3. Refer to the gearmotor instructions for any additional tests that may be required.

7.2 CLOSE THE ENCLOSURE

Close the enclosure in which the board is housed by referring to the specific instructions.

7.3 FINAL OPERATIONS

Make sure that the system delivery requirements have been fulfilled (otherwise arrange for them) i.e. that they correspond to the board installed / replaced.

8. ACCESSORIES

8.1 CLOSING PHOTOCELLS

 Photocells are additional type D detection devices (according to EN 12453) that reduce the likelihood of contact with the moving leaf, but they are not safety devices according to standard EN 12978.

 Use photocells with a NC relay contact. If multiple photocells are used, the contacts must be connected in series.

The photocells are only active during closing and must be positioned so that the access is monitored when it is closing. Connect as indicated in  3 (one pair or two pairs in series).

When an obstacle is detected:

- if the gate is stopped, they prevent it from closing
- if the gate is closing, they cause it to reverse

Configure the SAFE CL input to connect the photocells: function $S_c = PH$ in programming.

■ FailSafe

Failsafe is a functional test that is carried out before a movement. It consists of momentarily interrupting the power supply to the devices and checking the change in status of the input.

If the test fails, the board prevents the automation from moving (error 5).

To carry out the test, connect the negative of the transmitter to the TEST OUT terminal.

To enable/disable the failsafe, see programming function F_5 .

8.2 SENSITIVE EDGES

 If the sensitive edge is used to protect against a hazard, it must comply with standard EN 12978.

The E844 3PH board has two inputs for connecting sensitive edges that are active during closing (SAFE CL) or during opening (SAFE OP).

The activation of a sensitive edge causes the direction of movement to reverse, which can be:

- complete if $iP = n0$ in programming
- partial (3 s) if $iP = 4$ in programming

The SAFE CL and SAFE OP inputs can be configured to connect the following types of devices:

- with NC contact ($S_o/S_c = n_c$)
- resistive 8.2 k Ω ($S_o/S_c = rE$)

DO NOT connect photocells if the SAFE CL input is configured to connect a sensitive edge.

■ 1 pair of photocells

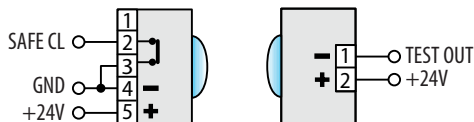

■ 2 pair of photocells

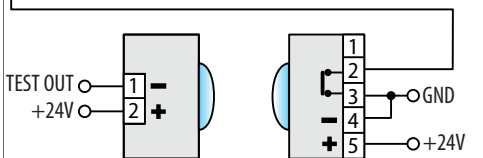
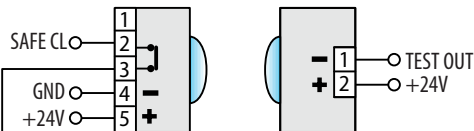

 3

 By default, the SAFE CL and SAFE OP inputs are configured to connect resistive type sensitive edges. If one or both are not used, set function S_o and/or $S_c = n_c$ and bridge with the common contacts (GND terminal), otherwise they would be active.

1. Configure the input to which the sensitive edge is connected according to the type used (functions S_o/S_c in programming).
2. If the connected device requires a functional test to be carried out, use the TEST OUT terminal. Refer to the instructions that come with the device for connecting it.

■ FailSafe

Failsafe is a functional test that is carried out before a movement.

If the test fails, the board prevents the automation from moving (error 5).

To enable/disable the failsafe, see programming function F_5 .

8.3 BUS 2EASY DEVICES

It is possible to connect FAAC BUS 2easy devices (photocells, control devices) to this board.

i If no BUS 2easy accessories are used, leave connector CN10 free. Do not bridge.

CONNECTION

Connect any BUS 2easy devices (photocells and control devices) to connector CN10.

i The overall length of the BUS 2easy cables must not exceed 100 m.
The BUS line does not require a matching polarity connection.

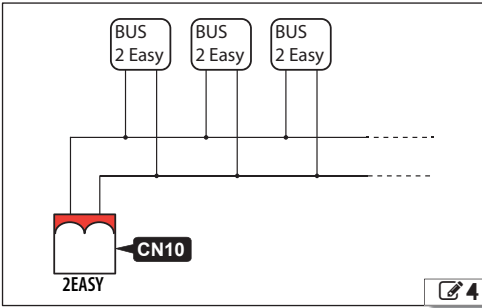

BUS 2EASY PHOTOCELLS

Type of use:

Closing photocells	Active during closing	When an obstacle is detected, they stop the gate and reopen it.
Photocells used as pulse generators	Always active	When an obstacle is detected, they send an OPEN command

1. Assign an address to the BUS 2easy photocells by setting the four Dip switches on both the transmitter and the corresponding receiver.

5 Assigning an address to the photocells.

1 0 0 0	
1 0 0 1	
1 0 1 0	
1 0 1 1	CL FSW
1 1 0 0	
1 1 1 0	
1 1 1 1	OPEN



i The transmitter and receiver of a pair of photocells must have the same DIP switch settings.
There must never be two or more pairs of photocells with the same DIP switch settings. If there is more than one pair of photocells with the same address, a conflict error is generated.

- Register the BUS 2easy photocells (Function **b_u**).
- Check the status of BUS and BUS MON LEDs.
- Check that the photocells are operating correctly. When the gate is moving, interrupt the beam with an obstacle and check the LEDs on the photocells, the status of the bus on the display and the automation system operate according to the type of photocell installed.

BUS 2EASY CONTROL DEVICES

1. Position the DIP switches to assign the commands.

i Stop NC also generates a stop when the device is disconnected. A command (e.g.: OPEN_A_1) must be used on only one of the connected devices.

6 Addressing control devices

0 0 0 0	Open_A_1
0 0 0 1	Open_A_2
0 0 1 0	Open_A_3
0 0 1 1	Open_A_4
0 1 0 0	Open_A_5
0 1 0 1	Stop
0 1 1 0	Stop_NC_1
0 1 1 1	Stop_NC_2
1 0 0 0	Close
1 0 0 1	Open_B_1
1 0 1 0	Open_B_2
1 0 1 1	Open_B_3
1 1 0 0	Open_B_4
1 1 0 1	Open_B_5
1 1 1 0	/
1 1 1 1	/

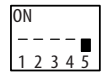

1 command
DIP switch 5 = 0
(OFF)

0 0 0 0	Open A_1	Open B_1
0 0 0 1	Open A_1	Open B_2
0 0 1 0	Open A_1	Stop
0 0 1 1	Open A_1	Close
0 1 0 0	Open A_2	Open B_1
0 1 0 1	Open A_2	Open B_2
0 1 1 0	Open A_2	Stop
0 1 1 1	Open A_2	Close
1 0 0 0	Open A_3	Open B_3
1 0 0 1	Open A_3	Open B_4
1 0 1 0	Open A_3	StopNC_1
1 0 1 1	Open A_3	Close
1 1 0 0	Open A_4	Open B_3
1 1 0 1	Open A_4	Open B_4
1 1 1 0	Open A_4	StopNC_2
1 1 1 1	Open A_4	Close



2 commands
DIP switch 5 = 1
(ON)

2. Register the BUS 2easy control devices (Function BU).
3. Check the status of BUS and BUS MON LEDs.
4. Check that the devices are working properly. Use the controls to move the gate. Check the LEDs on the devices, the status of the bus on the display and make sure that the automation system operates according to the type of device installed.

BUS 2EASY DEVICE REGISTRATION

Registration is required:

- When the automation system is first started or after the board has been replaced.
- Following any changes (addition, replacement or removal) to the BUS 2easy devices.

Registration procedure:

1. Select the BU function in programming. When F is released, the display shows the status of the BUS 2easy devices.
2. Press and hold the + and - buttons simultaneously for at least 5 seconds until 5 appears. The registration is complete.
3. Release the + and - buttons. The display shows the status of the BUS 2easy devices.
4. Check the status of the LEDs on the display (5).

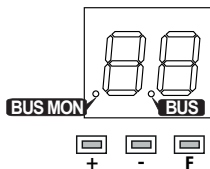

BUS MON Led - BUS 2easy line

- Line monitoring. LED always on
- * Line short-circuited
- * Error on the devices

BUS Led - BUS 2easy devices

- At least one device is engaged/active
- No device is engaged/active



Registered device verification procedure:

1. Select the BU function in programming. After registering one or more devices, BU displays segment 13 on.
2. Press and hold the + button and keep it pressed; the segments relative to the registered devices will come on. Each segment of the display corresponds to a type of device:

1	Open A control device
2	Open B control device
3	Closing photocells
4	Photocells for Open impulse
5	Not used
6	Close control device
7	Not used
8	Stop control device
9	Not used
10	Not used
11	Not used
12	Not used
13	BUS 2easy status
14	Not used

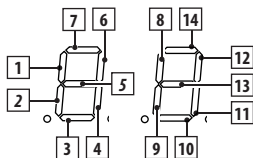

no	No device registered
cc	BUS 2easy line short-circuited
Er	BUS 2easy line error

9. DIAGNOSTICS

9.1 FIRMWARE VERSION

The firmware version is show on the display for one second each time it is switched on.

9.2 LEDS CHECK

▣ 7 bold indicates the condition of the LEDs with the board powered, the gate at its halfway position and no connected device active (●=on ; ○=off).

9.3 AUTOMATED SYSTEM STATUS

The display, other than when in the programming menu, provides information regarding the status of the automation system (▣ 8).

9.4 ALARMS/ERRORS

▣ 9 indicates the meaning of the relative codes.

▣ 7 Status of the LEDs

LED	meaning	●	○
STOP	Stop command	not active	active
CL - H	Priority close command	active	not active
OP - H	Priority open command	active	not active
SAFE CL	Closing safety device	not active	active
SAFE OP	Opening safety device	not active	active
OPEN B	Partial motion command	active	not active
OPEN A	Total motion command	active	not active
FCA	Opening limit switch	not engaged	engaged
FCC	Closing limit switch	not engaged	engaged
BUS	Bus Zeasy devices	See § BUS Zeasy devices	
BUS MON	Bus Zeasy line		

▣ 8 Automated system status

display	meaning
00	gate closed
01	gate open
03	gate stopped
04	gate stopped in pause
05	gate opening
06	gate closing
09	gate pre-flashing, then opens
10	gate pre-flashing, then closes

▣ 9 Alarms/Errors

display	meaning
AL 27	obstacle detected
Er 05	failsafe test failed
Er 15	motion timeout

10. MAINTENANCE

RISKS



PERSONAL PROTECTIVE EQUIPMENT



Always shut off the power supply before performing any maintenance operations. If the disconnect switch is not in view, apply a warning sign stating "WARNING - Maintenance in Progress". Restore the power supply only after finishing any maintenance work and restoring the area to normal.



Maintenance must be performed by the installer or a maintenance technician.
Follow all safety recommendations and instructions given in this manual.
Mark off the work site and prohibit access/transit. Do not leave the work site unattended.
The work area must be kept tidy and clear upon completing maintenance.
Before starting work, wait for any hot components to cool down.
Do not make any modifications to the original components.
FAAC S.p.A. shall bear no liability for damage or injury due to components that have been modified or otherwise tampered with.



The warranty shall be forfeited in the event of tampering with components.
Only use original FAAC spare parts.

10.1 ROUTINE MAINTENANCE

10 lists the operations that should be performed on a regular basis on the E844 3PH board in order to keep the automation working reliably and safely; these are given purely as a guideline and should not be considered exhaustive. The installer/machine manufacturer is responsible for drawing up the maintenance plan for the automation, supplementing this list or modifying the maintenance operations on the basis of the machine characteristics.

10 Scheduled maintenance

Operation	Frequency
Electronic equipment	
Check that the power supply and connecting cables and the cable glands are intact.	12
Check that the connectors and wiring are intact.	12
Check the integrity of the plastic board protection covers.	12
Check that there are no signs of overheating, burning etc. of electronic components.	12
Check that the earth connections are intact.	12
Check the operation of the circuit breaker and differential switch.	12
Control devices	
Check that the installed devices and radio controls are in good condition and that they operate correctly.	12
Sensitive edges	
Check condition, fastening and correct operation.	6
Photocells	
Check condition, fastening and correct operation.	6
Check the posts, ensuring that they are intact, correctly fastened and free of deformation etc.	6
Flashing light	
Check condition, fastening and correct operation.	12
Complete automation system	
Check that the automation system operates correctly, according to the set parameters, when using the various control devices.	12
Check that the gate moves correctly - smooth, regular and without abnormal noise.	12
Check that both the opening and closing speed are correct and that the stop positions and slow-downs provided for are respected.	12
Check that the manual release operates correctly: when the release mechanism is activated, it must only be possible to move the gate manually.	6
Check that the maximum force required for manual movement of the gate is below 225 N in residential areas and 390 N in industrial or commercial settings.	6
Check that the safety edges operate correctly when faced with an obstacle.	6
Check that each pair of photocells is working correctly.	6
Check that there is no optical/light interference between the pairs of photocells.	6
Check the force limitation curve (standards EN 12453 and EN 12445). For non-EU countries, if there are no specific local regulations, the force must be less than 150 N.	6



FAAC S.p.A. Soc. Unipersonale
Via Calari, 10 - 40069 Zola Predosa BOLOGNA - ITALY
Tel. +39 051 61724 - Fax +39 051 09 57 820
www.faac.it - www.faacgroup.com