

# EALINK

manufacturer of  
**video door phone**

Easy life  
Link the world

## EALINK

SHENZHEN EALINK TECHNOLOGY CO., LTD.

T: +86 755-89356265

F: +86 755-89350059

E: [info@ealink.com.cn](mailto:info@ealink.com.cn)

[www.ealink.com.cn](http://www.ealink.com.cn)



\* All rights reserved. Design and Specification are subject to change without notice.

# Company Profile

Shenzhen EALINK was founded in 2009, specialize in the R&D, production and sales of video door phones. Located in Dezhong Industrial Park Longgang Shenzhen.



Quality is our life! From the design, suppliers selection, materials approval, assembly, testing and shipment, we always keep our high standard to every process. All products passed CE and RoHS certification.

Our R&D team has over 15 years experience in video door phones field. Leading technical platform, stable performance, cost-effective and high efficiency are EALINK's core concept of product development.

Easy operation, user-friendly GUI and our own industrial design are our product features. Recent years, we successfully launched many hot-selling products and now you can meet our products in more than 30 countries.

Thanks for the continuous support from our partners and keep Shenzhen EALINK rapid growing every year. We will be maximally efforts to reach the win-win situation among customers, suppliers, employees and society. And we will do our best to make EALINK a respectable and world class manufacturer of video door phones.



## INDEX

2 wire IP Product .....1-7

4 wire Product .....8-24

CAT-5 Apartment System .....25-35





## 2-wire IP Product

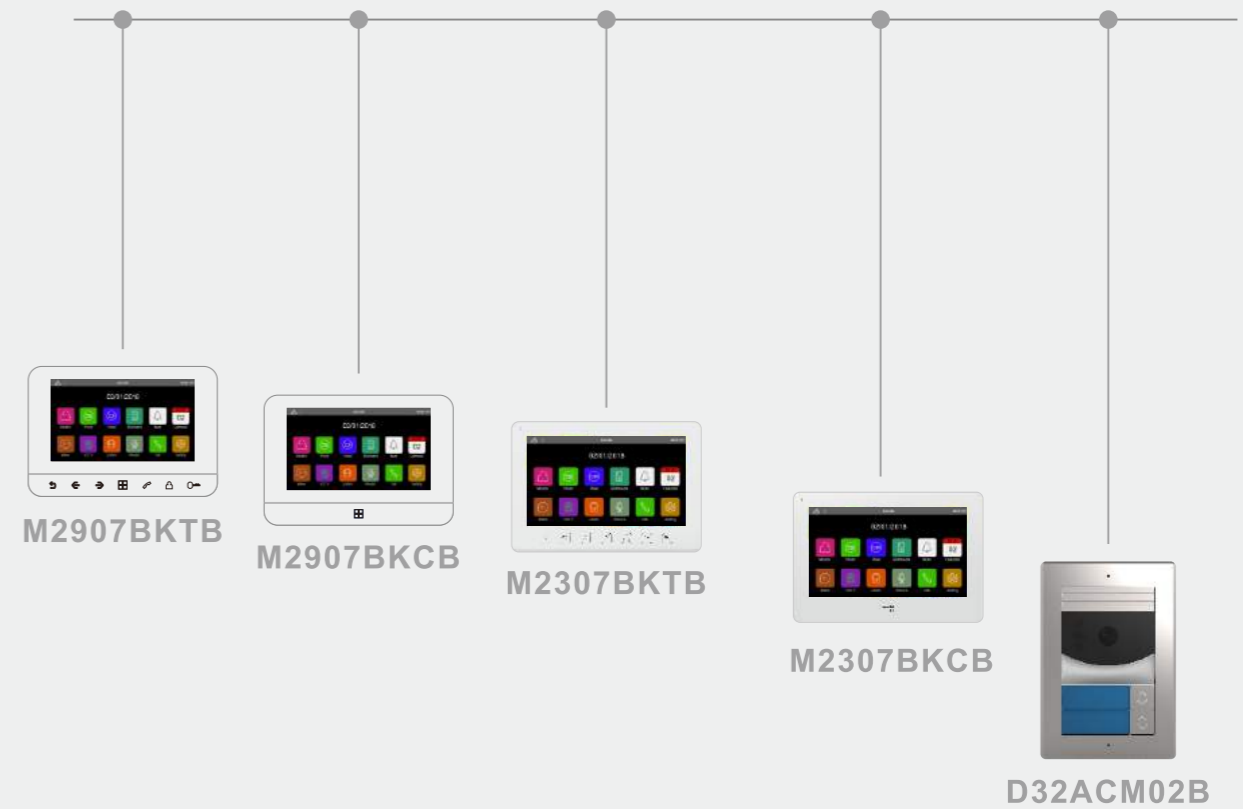

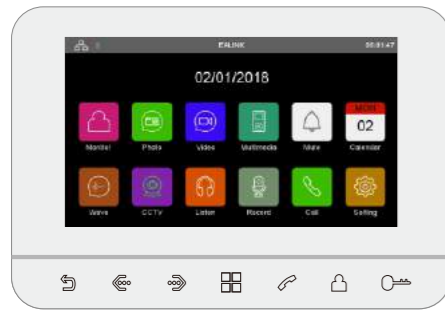

**Model: M2907BKTB New**  
 · 7 inch IP video door phone  
 · Fashion design, friendly use by touch button



Specification	M2907BKTB
Panel	7" digital TFT LCD
TFT resolution	800*480
Connection/ Effective length	2-wire nonpolarity /100m
External memory card	Micro SD card
Power(rated Power/standby power)	DC 15V(5W/1.5W)
Operation	Touch button
Dimension	208*143*22.5mm
Features	
Lock control	Yes
Multimedia	Yes
Image capturing	Yes
Video/audio record	Yes
Calendar&alarm clock	Yes
Voice message	Yes
Intercom	Yes and 100 Max.
Outdoor panel extension	Yes and 100 Max.
CCTV support	Yes and 2 Max.



**Model: M2907BKCB New**  
 · 7 inch IP video door phone  
 · Premier design, friendly use by touch screen



Specification	M2907BKCB
Panel	7" digital TFT LCD (capacitive touch screen)
TFT resolution	800*480
Connection/ Effective length	2-wire nonpolarity /100m
External memory card	Micro SD card
Power(rated Power/standby power)	DC 15V(5W/1.5W)
Operation	Touch screen
Dimension	208*143*22.5mm
Features	
Lock control	Yes
DVR	Yes
Multimedia	Yes
Image capturing	Yes
Video/audio record	Yes
Calendar&alarm clock	Yes
Voice message	Yes
Intercom	Yes and 100 Max.
Outdoor panel extension	Yes and 100 Max.
CCTV support	Yes and 2 Max.

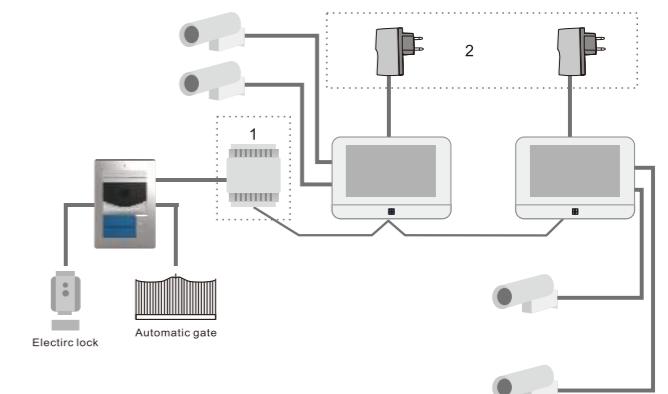
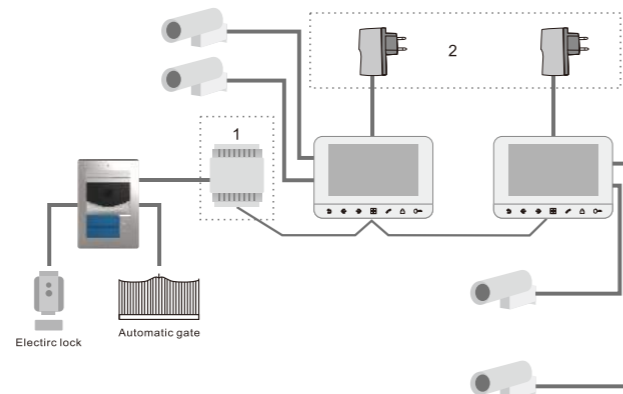



Model: M2307BKTB **New**

- 7 inch IP video door phone
- Fashionable design, friendly use by touch button



Specifications	M2307BKTB
Panel	7" digital TFT LCD
TFT resolution	800*480
Connection/ Effective length	2-wire nonpolarity /100m
External memory card	Micro SD card
Power(rated Power/standby power)	DC 15V(5W/1.5W)
Operation	Touch button
Dimension	185*127*17mm
Features	
Lock control	Yes
DVR	Yes
Multimedia	Yes
Image capturing	Yes
Video/audio record	Yes
Calendar&alarm	Yes
Voice message	Yes
Intercom	Yes and 100 Max.
Outdoor panel extension	Yes and 100 Max.
CCTV support	Yes and 2 Max.



Model: M2307BKCB **New**

- 7 inch IP video door phone
- Premier design, friendly use by touch screen



Specifications	M2307BKCB
Panel	7" digital TFT LCD(capacitive touch screen)
TFT resolution	800*480
Connection/ Effective length	2-wire nonpolarity /100m
External memory card	Micro SD card
Power(rated Power/standby power)	DC 15V(5W/1W)
Operation	Touch screen
Dimension	185*127*17mm
Features	
Lock control	Yes
DVR	Yes
Multimedia	Yes
Image capturing	Yes
Video/audio record	Yes
Calendar&alarm	Yes
Voice message	Yes
Intercom	Yes and 100 Max.
Outdoor panel extension	Yes and 100 Max.
CCTV support	Yes and 2 Max.

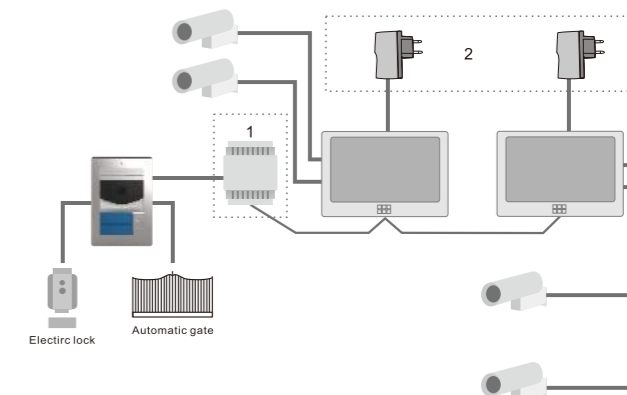
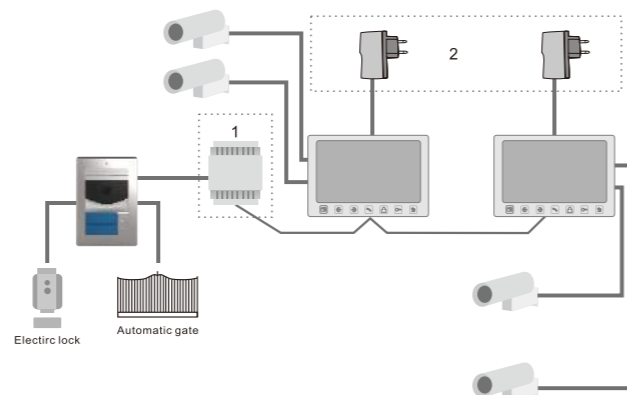



Model: D32ACM01B/ACM02B **New**

- 2 locks control
- Night vision
- Water proof
- Support 1/2 subscribers

Specification	D32ACM02B/ACM01B
Subscribers quantity	1/2
Camera image sensor	1/4" color CMOS
Viewing angle	110°
TV line	HD720P
Night vision	IR night LED
Installation method	Surface & Flush mounted
Operating temperature	-25°C ~ +60°C
Connection	2 wire nonpolarity
Lock control	12-24V AC/DC 2A NO
Gate control	12-24V DC Max 150mA NO
Power	15-24V
Dimension	100*151*28mm



## 4/wire Product





**Model: M2207BFCA**  
 · 7 inch pad design video door phone  
 · Friendly use by touch screen



Specifications	M2207BFCA
Panel	7" digital TFT LCD (capacitive touch screen)
TFT resolution	800*480
Connection/ Effective length	4 wire/100m
Video channels quantity	2 door bells+2 CCTVs
Monitor quantity	4
External memory card	Micro SD card
Power(rated Power/standby power)	DC15V (9W/1.5W)
Operation	Touch screen
Dimension	210*116*25mm
Features	
Lock control	Yes
Voice monitoring	Yes
Intercom transfer/ call/broadcast	Yes
DVR	Yes
Multimedia	Yes
Image capturing	Yes
Video/audio record	Yes
Calendar&alarm	Yes
Voice message	Yes

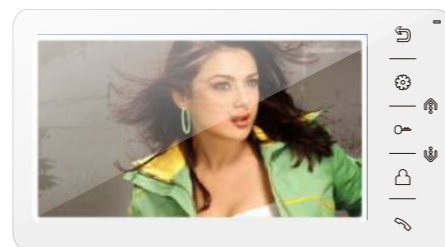
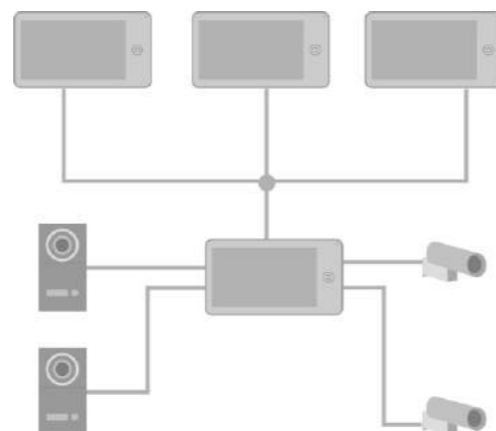

**Model: M2207AITA/EFTA/BFTA**  
 · 7 inch fashionable design  
 · Friendly use by touch button



Specifications	M2207AITA	M2207EFTA	M2207BFCA
Panel	7" digital TFT LCD	7" digital TFT LCD	7" digital TFT LCD
TFT resolution	800*480	800*480	800*480
Connection/ Effective length	4 wire/100m	4 wire/100m	4 wire/100m
Video channels quantity	2 door bells+2 CCTVs	2 door bells+2 CCTVs	2 door bells+2 CCTVs
Monitor quantity	4	4	4
External memory card	No	Micro SD card	Micro SD card
Power(rated Power/standby power)	DC15V (7W/0.7W)	DC15V (7W/1.5W)	DC15V (7W/1.5W)
Operation	Touch button	Touch button	Touch button
Dimension	210*116*25mm	210*116*25mm	210*116*25mm
Features			
Lock control	Yes	Yes	Yes
Voice monitoring	Yes	Yes	Yes
Intercom transfer/ call/broadcast	Yes	Yes	Yes
DVR	No	No	Yes
Multimedia	No	Yes	Yes
Image capturing	No	Yes	Yes
Video/audio record	No	No	Yes
Calendar&alarm clock	No	Yes	Yes
Voice message	No	No	Yes

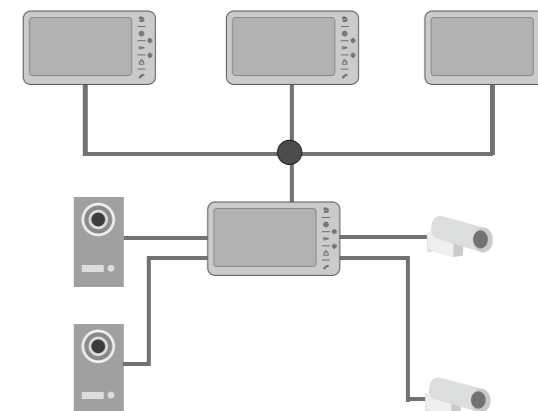



**Model: M1707AITA/EFTA/BFTA**

- 7 inch fashionable design
- Friendly use by touch button



Specifications	M1707AITA	M1707EFTA	M1707BFTA
Panel	7" digital TFT LCD	7" digital TFT LCD	7" digital TFT LCD
TFT resolution	800*480	800*480	800*480
Connection/ Effective length	4 wire/100m	4 wire/100m	4 wire/100m
Video channels quantity	2 door bells+2 CCTVs	2 door bells+2 CCTVs	2 door bells+2 CCTVs
Monitor quantity	4	4	4
External memory card	No	Micro SD card	Micro SD card
Power(rated power/standby power)	DC15V (9W/0.7W)	DC15V (9W/1.5W)	DC15V (9W/1.5W)
Operation	Touch button	Touch button	Touch button
Dimension	234*120*25mm	234*120*25mm	234*120*25mm
<b>Features</b>			
Lock control	Yes	Yes	Yes
Voice monitoring	Yes	Yes	Yes
Intercom transfer/ call/broadcast	Yes	Yes	Yes
DVR	No	No	Yes
Multimedia	No	Yes	Yes
Image capturing	No	Yes	Yes
Video/audio record	No	No	Yes
Calendar&alarm clock	No	Yes	Yes
Voice message	No	No	Yes

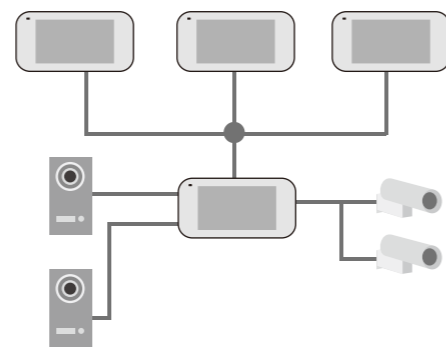

**Model: M2307AITA/EFTA/BFTA**

- 7 inch modern and super-slim design
- Friendly use by touch button



Specifications	M2307AITA	M2307EFTA	M2307BFTA
Panel	7" digital TFT LCD	7" digital TFT LCD	7" digital TFT LCD
TFT resolution	800*480	800*480	800*480
Connection/ Effective length	4 wire/100m	4 wire/100m	4 wire/100m
Video channels quantity	2 door bells+2 CCTVs	2 door bells+2 CCTVs	2 door bells+2 CCTVs
Monitor quantity	4	4	4
External memory card	No	Micro SD card	Micro SD card
Power(rated Power/standby power)	DC15V/1A (7W/0.7W)	DC15V/1A (7W/1.5W)	DC15V (9W/1.5W)
Operation	Touch button	Touch button	Touch button
Dimension	185*127*17mm	185*127*17mm	185*127*17mm
<b>Features</b>			
Lock control	Yes	Yes	Yes
Voice monitoring	Yes	Yes	Yes
Intercom transfer/ call/broadcast	Yes	Yes	Yes
DVR	No	No	Yes
Multimedia	No	Yes	Yes
Image capturing	No	Yes	Yes
Video/audio record	No	No	Yes
Calendar&alarm clock	No	Yes	Yes
Voice message	No	No	Yes

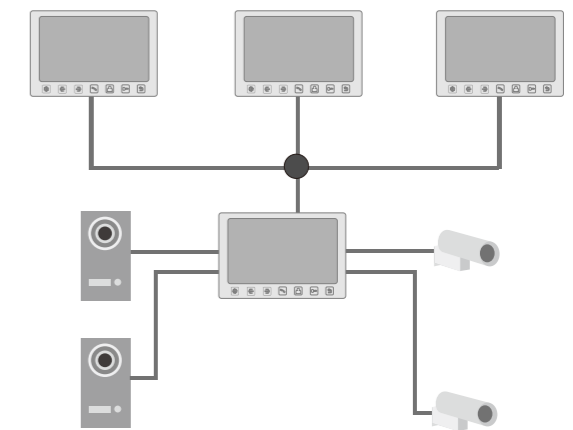



## Model: M2307BFCA

- 7 inch premier design
- Friendly use by touch screen



Features:



Specifications	M2307BFCA
Panel	7" digital TFT LCD (capacitive touch screen)
TFT resolution	800*480
Connection/ Effective length	4 wire/100m
Video channels quantity	2 door bells+2 CCTVs
Monitor quantity	4
External memory card	Micro SD card
Power(rated Power/standby power)	DC15V/1A (9W/2W)
Operation	Touch screen
Dimension	185*127*17mm
Features	
Lock control	Yes
Voice monitoring	Yes
Intercom transfer/ call/broadcast	Yes
DVR	Yes
Multimedia	Yes
Image capturing	Yes
Video/audio record	Yes
Calendar&alarm clock	Yes
Voice message	Yes

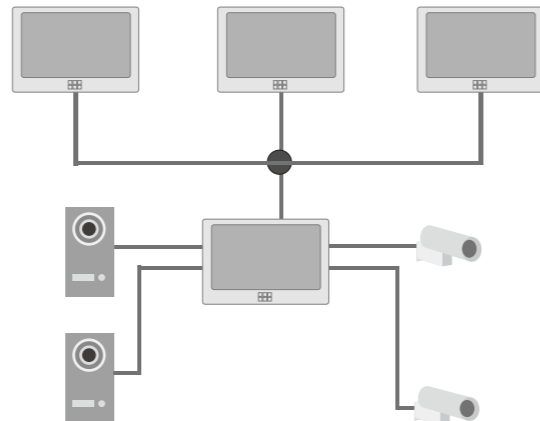

## Model: M2604AIHA/EFTA

- 4.3 inch simple and classic design
- Friendly use by touch button



Features:



Specifications	M2604AIHA	M2604EFTA
Panel	4.3" digital TFT LCD	4.3" digital TFT LCD
TFT resolution	480*272	480*272
Connection/ Effective length	4 wire/100m	4 wire/100m
Video channels quantity	2 door bells	2 door bells
Monitor quantity	4	4
Power(rated Power/standby power)	DC14.5V/0.8A (5W/0.3W)	DC14.5V/0.8A (5W/1W)
Operation	Touch button	Touch button
Dimension	180*112*17mm	180*112*17mm
Features		
Lock control	Yes	Yes
Voice monitoring	Yes	Yes
Intercom transfer/ call/broadcast	Yes	Yes
DVR	No	No
Multimedia	No	Yes
Image capturing	No	Yes
Video/audio record	No	No
Calendar&alarm clock	No	Yes
Voice message	No	No

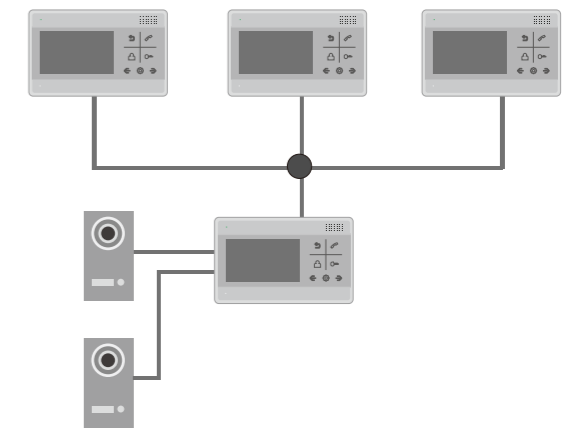

# EALINK



## Model: M2804AIHA/M2804EFTA

- 4.3 inch flat design with high glossy finishing
- Friendly use by touch button



Specifications	M2804AIHA	M2804EFTA
Panel	4.3" digital TFT LCD	4.3" digital TFT LCD
TFT resolution	480*272	480*272
Connection/ Effective length	4 wire/100m	4 wire/100m
Video channels quantity	2 door bells	2 door bells
Monitor quantity	4	4
Power(rated Power/standby power)	DC14.5V/0.8A (5W/0.3W)	DC14.5V/0.8A (5W/1W)
Operation	Touch button	Touch button
Dimension	180*112*17mm	180*112*17mm
<b>Features</b>		
Lock control	Yes	Yes
Voice monitoring	Yes	Yes
Intercom transfer/ call/broadcast	Yes	Yes
DVR	No	No
Multimedia	No	Yes
Image capturing	No	Yes
Video/audio record	No	No
Calendar&alarm clock	No	Yes
Voice message	No	No

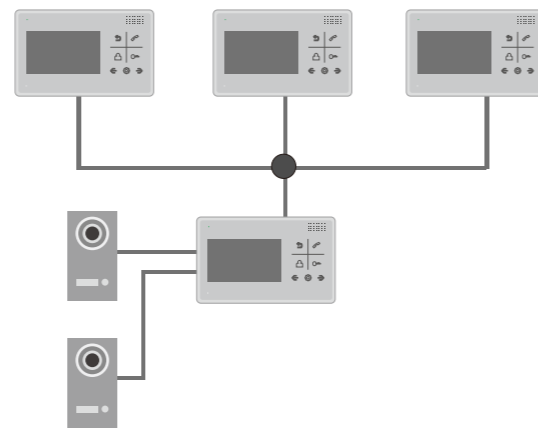

# EALINK



## Model: M3004AIHA **New**

- 4.3 inch classic design
- Friendly use by touch button
- Hand-free and Handset are optional



Specifications	M3004AIHA
Panel	4.3" digital TFT LCD
TFT resolution	480*272
Connection/ Effective length	4 wire/100m
Video channels quantity	2 door bells
Monitor quantity	4
Power(rated Power/standby power)	DC14.5V/0.8A (5W/0.3W)
Operation	Touch button
Dimension	180*160*29mm
<b>Features</b>	
Lock control	Yes
Voice monitoring	Yes
Intercom transfer/ call/broadcast	Yes
DVR	No
Multimedia	No
Image capturing	No
Video/audio record	Yes
Calendar&alarm clock	No
Voice message	No

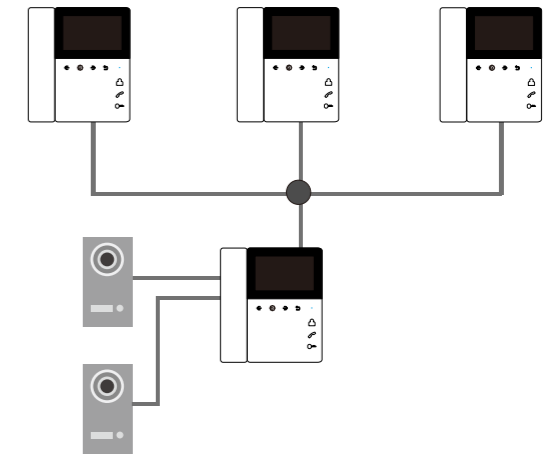

# EALINK



## Model: M3004BFHA **New**

- 4.3 inch classic design
- Friendly use by touch button
- Hand-free and Handset are optional

Features:



Specifications	M3004BFHA
Panel	4.3" digital TFT LCD
TFT resolution	480*272
Connection/ Effective length	4 wire/100m
Video channels quantity	2 door bells
Monitor quantity	4
Power(rated Power/standby power)	DC14.5V/0.8A (5W/1W)
Operation	Touch button
Dimension	180*160*29mm
Features	
Lock control	Yes
Voice monitoring	Yes
Intercom transfer/ call/broadcast	Yes
DVR	Yes
Multimedia	Yes
Image capturing	Yes
Video/audio record	Yes
Calendar&alarm clock	Yes
Voice message	Yes

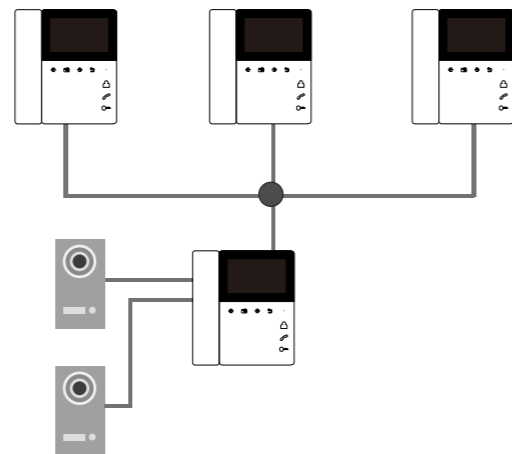

# EALINK

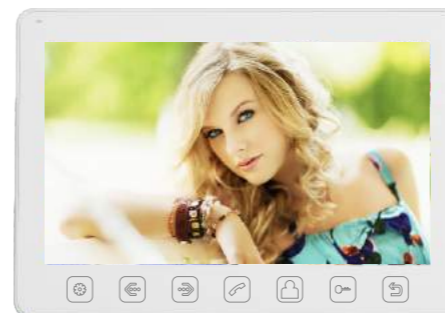

## Model: M2510ADTA

- 10.1 inch large screen in premier design
- Friendly use by touch button
- Can work as a monitor with DVR connection

Features:



Specifications	M2510ADTA
Panel	10.1" digital TFT LCD
TFT resolution	1024*600
Connection/ Effective length	4 wire/100m
Video channels quantity	2 door bells+2 CCTVs
Monitor quantity	4
Power(rated Power/standby power)	DC14.5V/0.8A (7W/1W)
Operation	Touch button
Dimension	258*178*19.7mm
Features	
Lock control	Yes
Voice monitoring	Yes
Intercom transfer/ call/broadcast	Yes
DVR	No
Multimedia	No
Image capturing	No
Video/audio record	No
Calendar&alarm clock	No
Voice message	No

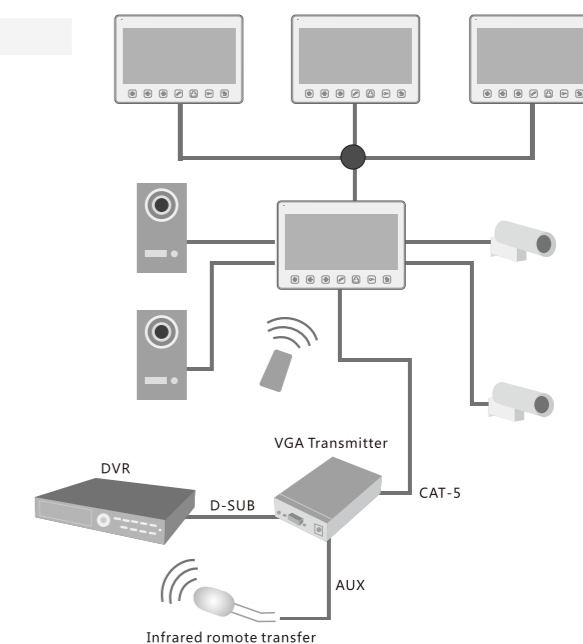



**Model: M2509BFCA**  
 • 9 inch large screen in luxury design  
 • Friendly use by touch screen



Specification	M2509BFCA
Panel	9" digital TFT LCD (capacitive touch screen)
TFT resolution	800*480
Connection/ Effective length	4 wire/100m
Video channels quantity	2 door bells+2 CCTVs
Monitor quantity	4
External memory card	Micro SD card
Power(rated Power/standby power)	DC14.5V/0.8A (9W/1W)
Operation	Touch screen
Dimension	258*178*19.7mm
Features	
Lock control	Yes
Voice monitoring	Yes
Intercom transfer/ call/broadcast	Yes
Multimedia	Yes
Image capturing	Yes
Video/audio record	Yes
Calendar&alarm clock	Yes
Voice message	Yes

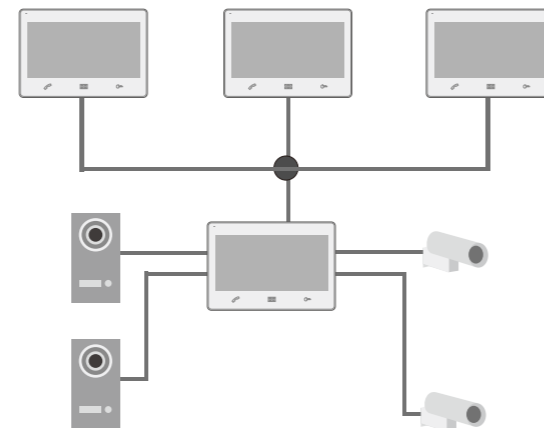

**Model: D23ACM01A**  
 • Acrylic /Aluminum front panel  
 • Lock control  
 • Night vision  
 • Water proof  
 • Support 1 subscriber

Specification	D23ACM01A
Subscribers quantity	1
Camera image sensor	1/4" color CMOS
Viewing angle	110°
TV line	700
Installation method	Surface mounted
Operating temperature	- 25 °C to + 60°C
Connection	4 wire
Lock control	Yes
Power	DC 11 - 13V
Dimension	133.2*48*15.5mm
Support lock type	DC5-24V electric lock





**Model: D23CCM01A**

- Acrylic front panel
- Lock control
- Night vision
- Water proof
- Support 1 subscriber
- Support IC card

Specification	D23ACM01A
Subscribers quantity	1
Camera image sensor	1/4" color CMOS
Viewing angle	110°
TV line	700
Installation method	Surface mounted
Operating temperature	- 25 °C to + 60°C
Connection	4 wire
Lock control	Yes
Power	DC 11 - 13V
Dimension	133.2*48*15.5mm
Support lock type	DC5-24V electric lock



**Model: D27ACM0XA**

- Aluminum front panel
- 2 locks control
- Night vision
- Water proof
- Support 2/4 subscribers

Specification	D27ACM0XA
Subscribers quantity	2/4
Camera image sensor	1/4" color CMOS
Viewing angle	110°
TV line	700
Installation method	Surface mounted
Operating temperature	- 25 °C to + 60°C
Connection	4 wire
Power	DC11-14V
Dimension	144*55*20mm





**Model: D31ACM01A**

- Lock control
- Night vision
- Water proof
- Support 1 subscriber

Specification	D31ACM01A
Subscribers quantity	1
Camera image sensor	1/4" color CMOS
Viewing angle	53°
TV line	600
Installation method	Surface mounted
Operating temperature	- 25 °C to + 60°C
Connection	4 wire
Lock control	Yes
Power	11 - 13V
Dimension	160*48*29mm
Support lock type	DC5-24V electric lock



**Model: D26ACM0XA**

- 2 locks control
- Night vision
- Water proof
- Support 1/2/4 subscribers

Specification	D26ACM0XA
Subscribers quantity	1/2/4
Camera image sensor	1/4" color CMOS
Viewing angle	110°
TV line	700
Installation method	Surface mounted
Operating temperature	-25 °C to + 60°C
Connection	4 wire or 5 wire
Lock control	Yes
Power	11 - 13V
Dimension	130*88*24mm



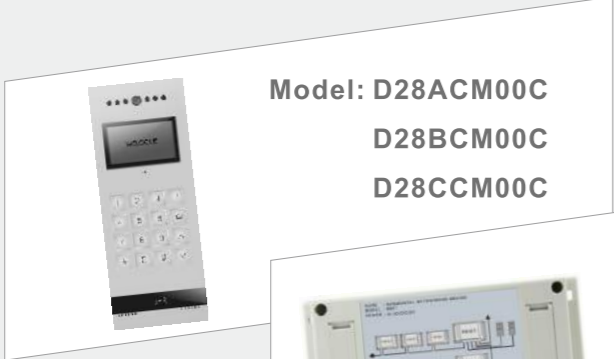

Model: D28ACM00C  
D28BCM00C  
D28CCM00C



Model: NH01

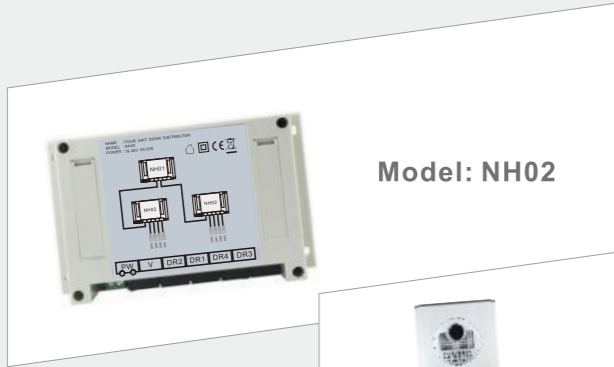

Model: NH02



Model: D21CCM00C

## CAT-5 Apartment system



Model: NV01



Model: PW01

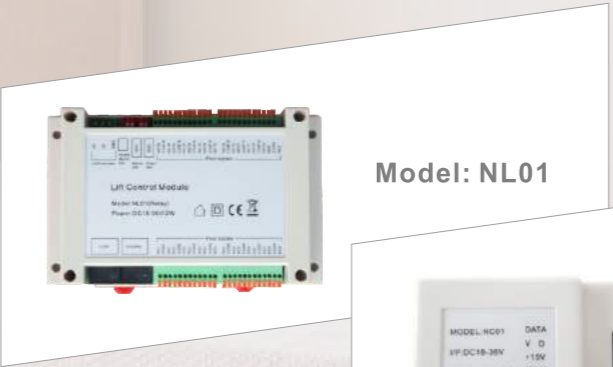

Model: NL01



Model: NC01



**Model: D28ACM00C/BCM00C/CCM00C**

- Lock control
- Night vision
- IC/ID card unlock
- HD COMS camera
- Support up to 9,999 subscribers

Specification	D28ACM00C	D28BCM00C	D28CCM00C
Subscribers quantity	up to 9,999 subscribers	up to 9,999 subscribers	Up to 9,999
Camera image sensor	1/4" CMOS	1/4" CMOS	1/4" CMOS
Installation method	Surface/flush mounted	Surface/flush mounted	Surface/flush mounted
Operating temperature	-25°C to +60°C	-25°C to +60°C	-25°C to +60°C
Connection	CAT-5	CAT-5	CAT-5
Lock control	Yes	Yes	Yes
Power(rated power/standby power)	18-36V(5W/1.5W)	18-36V(5W/1.5W)	18-36V(5W/1.5W)
LCD	STN 128*64	STN 128*64	STN 128*64
ID card unlocking	No	Yes	IC Card
Dimension	370*140*28mm	370*140*28mm	370*140*28mm
Viewing angle	110°	110°	110°



**Model: D21CCM00C**

- Lock control
- Night vision
- Water proof
- Support up to 9,999 subscribers
- IC card unlock

Specifications	D21CCM00C
Subscribers quantity	Up to 9,999
Camera image sensor	1/4" color CMOS
Installation method	Flush mounted
Operating temperature	- 25 °C to + 60°C
Connection	CAT-5
Lock control	Yes
Power(Rated Power/standby power)	18-36V (4W/1.5W)
LCD	STN 128*64
ID/IC card unlocking	IC Card
Dimension	366*138.5*55mm
Viewing angle	56°





# EALINK

## Horizontal Networking Distributer

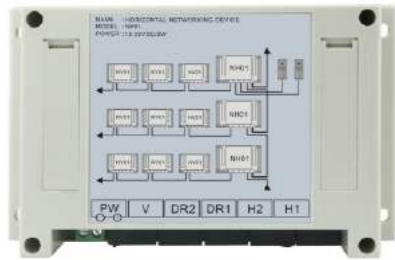

### Model: NH01

- Connection between doorbell to system.
- Transfer signal to different apartment units.

Specifications	NH01
Power	18- 36V DC/1W(Standby)/3W(Normal)
Interface mode	RJ45 / CAT-5
Support outdoor panel quantity	2
Horizontal networking distance(max)	1000m
Horizontal networking quantity(max)	99
Operating temperature	- 25 °C to + 60°C
Communication mode	CAN Bus
Dimension	145*90*40mm
Installation method	Surface/Din-rail mounted



# EALINK

## Vertical Distributer



### Model: NV01

- Install at floors
- Support 4 subscribers

Specifications	NV01
Power	18- 36V DC/ 0.8W(Standby)/2W(Normal)
Interface mode	RJ45 / CAT-5
Support indoor monitor quantity	4
Operating temperature	- 25 °C to + 60°C
Communication mode	CAN Bus
Dimension	145*90*40mm
Installation method	Surface/Din-rail mounted



# EALINK

## Device for 4 Outdoor Stations Extension

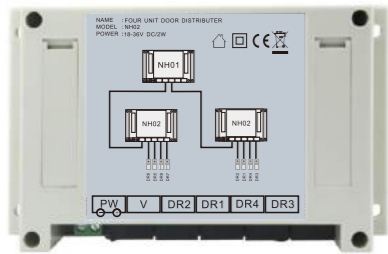

### Model: NH02

- Using for extending 4 outdoor panels

Specifications	NH02
Power	18- 36V DC/1W(Standby)/3W(Normal)
Interface mode	RJ45 / CAT-5
Support outdoor panel quantity	4
Operating temperature	- 25 °C to + 60°C
Communication mode	CAN Bus
Dimension	145*90*40mm
Installation method	Surface/Din-rail mounted



# EALINK

## System Power

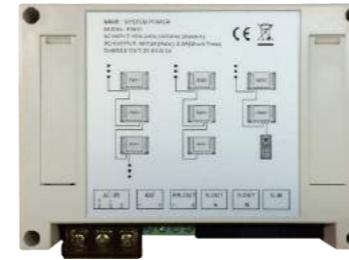

### Model: PW01

- Supply power for apartment system.
- Backup power control.

Specifications	PW01
AC input	100- 240V, 50Hz/60Hz
DC output	36V/2.5A
Support indoor monitor quantity	36
Interface mode	RJ45 / CAT-5
Operating temperature	- 25 °C to + 60°C
Battery charge out	27.6V/0.5A
Dimension	145*90*72mm
Installation method	Surface/Din-rail mounted
Optional	
Backup power	24V lead-acid battery



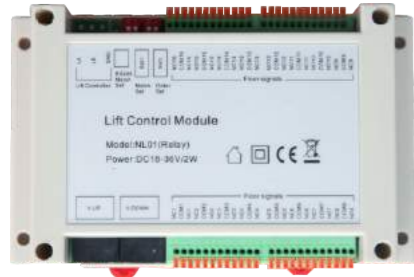

### Model: NL01

- Relay output, support all kinds of lift control system.
- Can support 64 floors MAX

Specifications	NL01
Operation voltage	DC18V-36V
Operation Currenty	200mA(max). 30mA(standby)
Operation temperature	-25°C to +50°C
Operation humiding	0%~95%
Lift control signal	16 channels relay output(NO/NC optional), no screw needed
Extended lift control module quantity	4 (64 floors MAX)
Communication mode	CAN Bus
Communication signal isolation mode	Optoelectronic isolation
Dimension	145*90*40mm

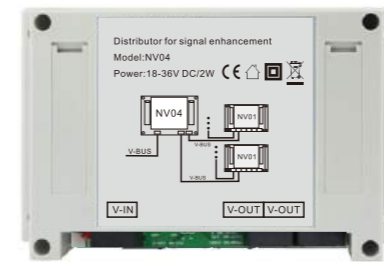

### Model: NV04

- Vertical Bus Distributor
- Vertical Bus Video Amplifier

Specification	NC04
Power input	18- 36V DC / 0.2A
IO	Rj45
Distribution channel	2
Dimension	145*90*40mm



# EALINK

Signal converter



**Model: NC01**

- Supply power for indoor monitor
- Signal transfer between NV01 and indoor monitor

Specification	NC01
Power input	18- 36V DC / 0.5A
Power output	DC15V / 0.5A
Dimension	46*27*20mm



# EALINK

## Apartment System Layout

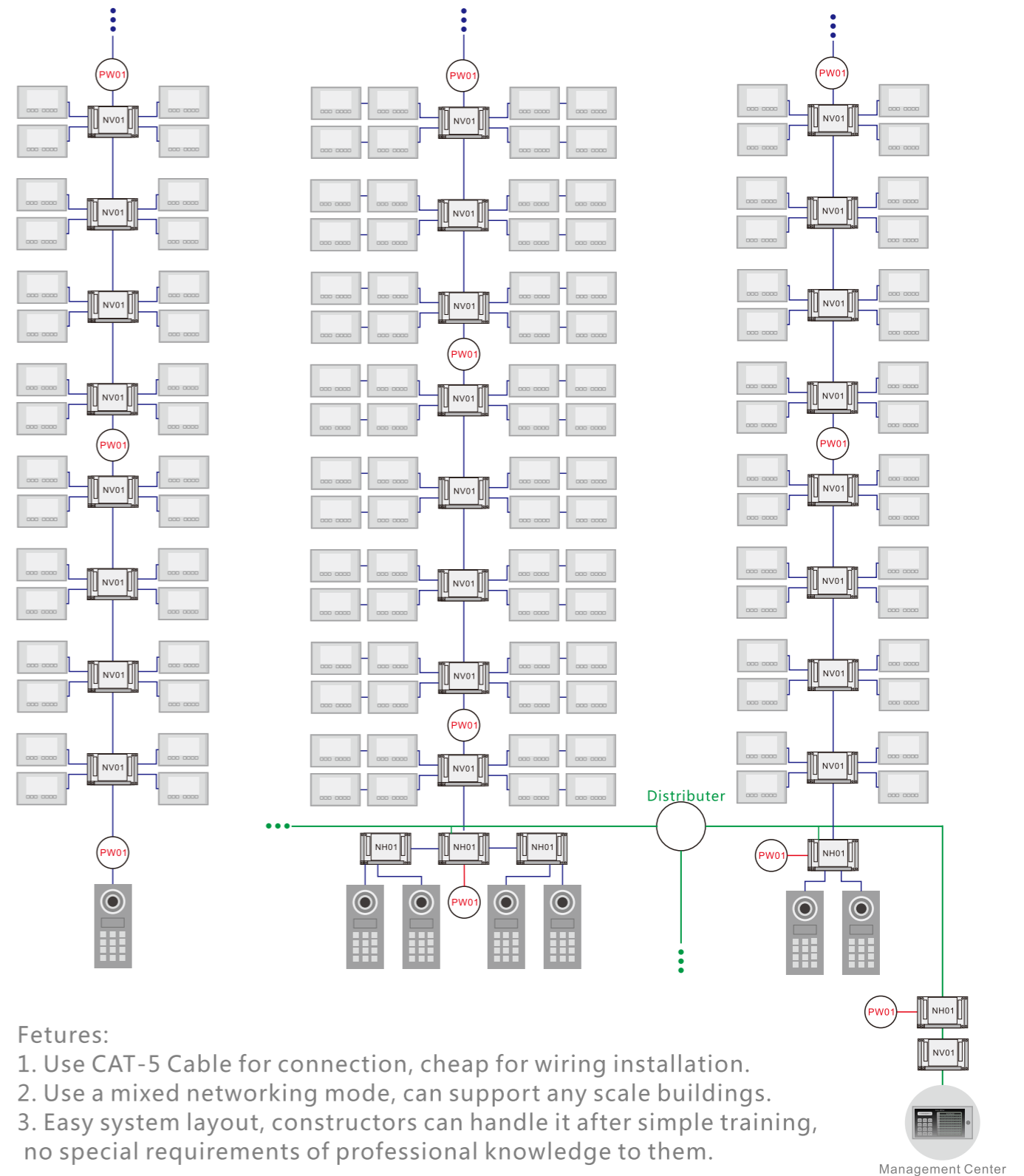

Features:

1. Use CAT-5 Cable for connection, cheap for wiring installation.
2. Use a mixed networking mode, can support any scale buildings.
3. Easy system layout, constructors can handle it after simple training, no special requirements of professional knowledge to them.