

Digital Surveillance Recorder

Operating Instructions

HSR-1/1P

Owner's Record

The model and serial numbers are located on the body of the unit. Record the serial number in the space provided below. Refer to these numbers whenever you call upon your Sony dealer regarding this product.

Model No. HSR-1 Serial No. _____

WARNING

To prevent fire or shock hazard, do not expose the unit to rain or moisture.

To avoid electrical shock, do not open the cabinet. Refer servicing to qualified personnel only.

THIS APPARATUS MUST BE EARTHED.

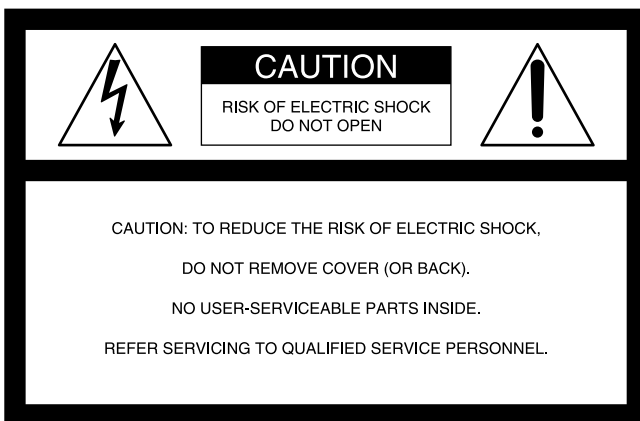

This symbol is intended to alert the user to the presence of uninsulated "dangerous voltage" within the product's enclosure that may be of sufficient magnitude to constitute a risk of electric shock to persons.



This symbol is intended to alert the user to the presence of important operating and maintenance (servicing) instructions in the literature accompanying the appliance.

For the customers in the USA

This equipment has been tested and found to comply with the limits for a Class A digital device, pursuant to Part 15 of the FCC Rules. These limits are designed to provide reasonable protection against harmful interference when the equipment is operated in a commercial environment. This equipment generates, uses, and can radiate radio frequency energy and, if not installed and used in accordance with the instruction manual, may cause harmful interference to radio communications. Operation of this equipment in a residential area is likely to cause harmful interference in which case the user will be required to correct the interference at his or her own expense.

You are cautioned that any changes or modifications not expressly approved in this manual could void your authority to operate this equipment.

This device requires shielded interface cables to comply with FCC emission limits.

Caution

Television programs, films, video tapes and other materials may be copyrighted. Unauthorized recoding of such material may be contrary to the provisions of the copyright laws.

Voor de landen in Nederland



Bij dit product zijn batterijen geleverd. Wanneer deze leeg zijn, moet u ze niet weggooien maar inleveren als KCA.

Table of Contents

Chapter 1

Overview

Features	1-1
Locations and Functions of Parts	1-4
Front Panel	1-4
Rear Panel	1-7
Screen Displays	1-8

Chapter 2

Basic Operations

Handling Cassettes	2-1
Usable Cassettes	2-1
Inserting a Cassette	2-2
Ejecting a Cassette	2-2
Monitoring Picture	2-3
Dividing the Screen	2-3
Switching the Pictures	2-4
Recording	2-5
Normal Recording	2-5
Playback	2-9
Normal Playback	2-9
Time Search	2-10

Chapter 3

Convenient Recording/Playback Functions

Timer Recording	3-1
Alarm Recording	3-4
Repeat Recording	3-7
Continuous Recording	3-8
Series Recording	3-9
Alarm Search	3-10
HDD Recording/Playback	3-11
High-Speed Playback	3-12

Table of Contents

Chapter 4

Menu Operations

Menu Operations	4-1
Layered Structure of the Menu Items	4-1
Basic Display Layout	4-2
Keys Used for Menu Operations	4-2
Setting the Menu Items	4-3
Returning to the Default Settings - Initializing	4-4
Menu Items	4-5
Top Menu (First Layer)	4-5
Image Control Menu	4-6
Indication Control Menu	4-8
Recording Function Menu (Enhanced Menu)	4-10
Function Control Menu	4-11
Remote Control Menu (Enhanced Menu)	4-13
Maintenance Menu (Enhanced Menu)	4-15

Chapter 5

Connections and Preparations

Connections	5-1
Video Cameras	5-1
Video Monitors	5-1
Remote Controls	5-1
Connection Examples	5-2
Setting the Clock	5-5
Settings	5-6
Selecting the Enhanced Menu Mode	5-6
Setting the Cameras to Use	5-6
Setting Camera Names	5-7
Setting the Display Structures	5-8
Setting the Automatic Change Cycle	5-10
Setting the Recording Modes	5-11
Setting Passwords	5-14

Chapter 6

Maintenance and Troubleshooting

Maintenance	6-1
Condensation	6-1
Head Cleaning	6-1
Regular Checks	6-2
Troubleshooting	6-4
Error Codes and Messages	6-5

Appendices

Notes on Use	A-1
Specifications	A-2
Index	I-1

Overview

Features

The HSR-1/1P Digital Surveillance Recorder is a hybrid security recorder that records pictures from multiple surveillance video cameras with a high picture quality for long periods of time.

Versatile Processing of Numerous Images

Four alternative picture quality modes

The HSR-1/1P can be switched among four levels of picture quality: Super, High, Middle and Low modes. This enables the appropriate balance between picture quality and recording time to be selected depending on the application. Super mode provides excellent picture quality with a horizontal resolution of more than 500 TV lines. High mode provides higher quality than that of conventional equipment, with resolution close to that of the S-VHS format and much higher S/N ratio. By selecting Middle or Low mode, you can prolong recording time compared with the upper modes.

Large storage capacity

Using DV cassette tape (270-minute tape) as the storage medium, the HSR-1/1P offers a large storage capacity of more than 60 gigabytes.

Long recording time

With its long-time recording capability, the HSR-1/1P releases you from frequent tape changes.

High refresh rate

The HSR-1/1P is capable of recording images at a high refresh rate (0.4 seconds at minimum) for each camera, so you no longer have to worry about failing to record key scenes.

High Reliability, Low Maintenance

Reduced use of tape mechanism

The hybrid configuration, with a hard disk and DV tape drive, makes it possible to achieve higher reliability. The tape transport and heads of the HSR-1/1P are idle most of the time because the DV tape drive works only while recording the image data being transferred from the hard disk.

Multiple Protection

In case of the failure of the DV tape drive, recording operation continues on the built-in hard disk. Conversely, the HSR-1/1P records the image data directly onto the DV tape if the hard disk fails. (In some cases, some of the data may be lost.) For additional protection, the HSR-1/1P always checks whether data is accurately recorded onto a tape. If a recording failure is detected, the HSR-1/1P re-records the same data onto the tape.

Less Space Required

Compact body

The HSR-1/1P features a compact body and is similar in width to a 14-inch monitor.

Compact storage medium

Using DV cassettes of only 1/3 the volume of VHS cassettes means your tape library takes up much less space.

System Versatility

16 Camera inputs

The HSR-1/1P has four camera inputs as standard. Up to three optional HSRA-11, four-input boards can be installed, so up to 16 camera inputs can be provided.

Built-in multiplexing capability

The HSR-1/1P has built-in multiplexing capability, which allows independent recording and monitoring. There is also a choice of various monitoring patterns by freely assigning multiple cameras to a single monitor.

Output for a second monitor

The HSR-1/1P has two monitoring outputs A and B, for which output images can be independently selected. For example, it is possible to monitor the image from one key camera on the B monitor, while checking playback on the A monitor.

Flexible camera assignment

There are five preset recording modes, which can be flexibly combined with your choice of picture quality mode, tape length, recording time, number of camera inputs and the recording cycle of each camera. This feature allows you to assign cameras as you like. It is possible, for instance, to record from all the cameras in High mode during the day and then select some of these cameras to be recorded from in Super mode at night.

RS-232C interface

The HSR-1/1P is equipped with an RS-232C interface for communication with external equipment such as a personal computer, to facilitate machine control, status reporting, parameter presetting and user data read/write.

37-pin parallel port

The HSR-1/1P has a 37-pin parallel I/O interface, whose pin functions can be freely configured for a particular application.

Recording/Playback Systems Not to Miss Any Important Scenes

Flexibility in Alarm Recording modes

To capture more and even sharper images, the HSR-1/1P not only changes its recording mode to the higher refresh and higher picture quality mode on alarm, but also performs interleaved recording, which accelerates the recording cycle of the camera in alarm status. It can also record images from the camera in alarm status only for a preset duration. In addition, since alarm and timer recordings can be combined, the HSR-1/1P can be set to normal recording mode during office hours and set to alarm recording at night.

Continuous recording function

The HSR-1/IP can continuously record images, even while you are changing or rewinding the tape, so you don't have to worry about the breakup of a recording.

Sophisticated security function

The key-lock function may prevent accidents, such as inadvertent break-off of important recording. For higher security, you can specify a password to release the key lock.

Watermark

Using an original watermark system, the HSR-1/IP can identify image data that has been artificially altered. When alteration is detected, a message is displayed on screen.

Intelligent search functions

Time search/alarm search

You can easily locate the picture from a specific date and time.

With a tape on which alarm recordings have been made, you can locate a specific picture after checking the list of those recordings.

Variable-speed search with a Jog/Shuttle dial

By connecting the optional SVRM-100A remote control unit, noiseless picture search can be carried out using its Jog/Shuttle dial.

Pre-alarm recording

Thanks to the Pre-alarm recording capability, recording can be started before catching a trigger signal, thus chances are you'll have the information you need on tape

Quick recording start

The HSR-1/IP can start recording the moment power is turned on. This allows immediate recovery of recording after a power failure.

High-quality frame recording

By selecting Frame Rec mode, you can record a single frame in response to an alarm in Hyper mode, which provides higher resolution than Super mode.

Power-failure backup function

The HSR-1/IP is equipped with a protection circuit (memory-backup circuit with a rechargeable battery) to prevent loss of video data caused by power failure. If the power fails during recording, the protection circuit activates, and stores video data for 24 hours. When power is restored, the unit automatically resumes recording mode and records the stored video data on the tape.

Notes

- At least 24 hours with the power on is required to fully charge the battery.
- Several frames captured immediately before the power failure may be lost.

Optional Devices

HSRA-11 Input Board

Up to three HSRA-11 boards can be mounted in the recorder and add four VIDEO IN connectors each.

For board installation, refer to the manual for the HSRA-11.

SVRM-100A Remote Control Unit

The tape transport of the HSR-1/IP can be controlled at hand.

Note

Tapes recorded on this unit cannot be played on other DV cassette players. Conversely, tapes recorded on other DV cassette recorders cannot be played on this unit.

Locations and Functions of Parts

Front Panel

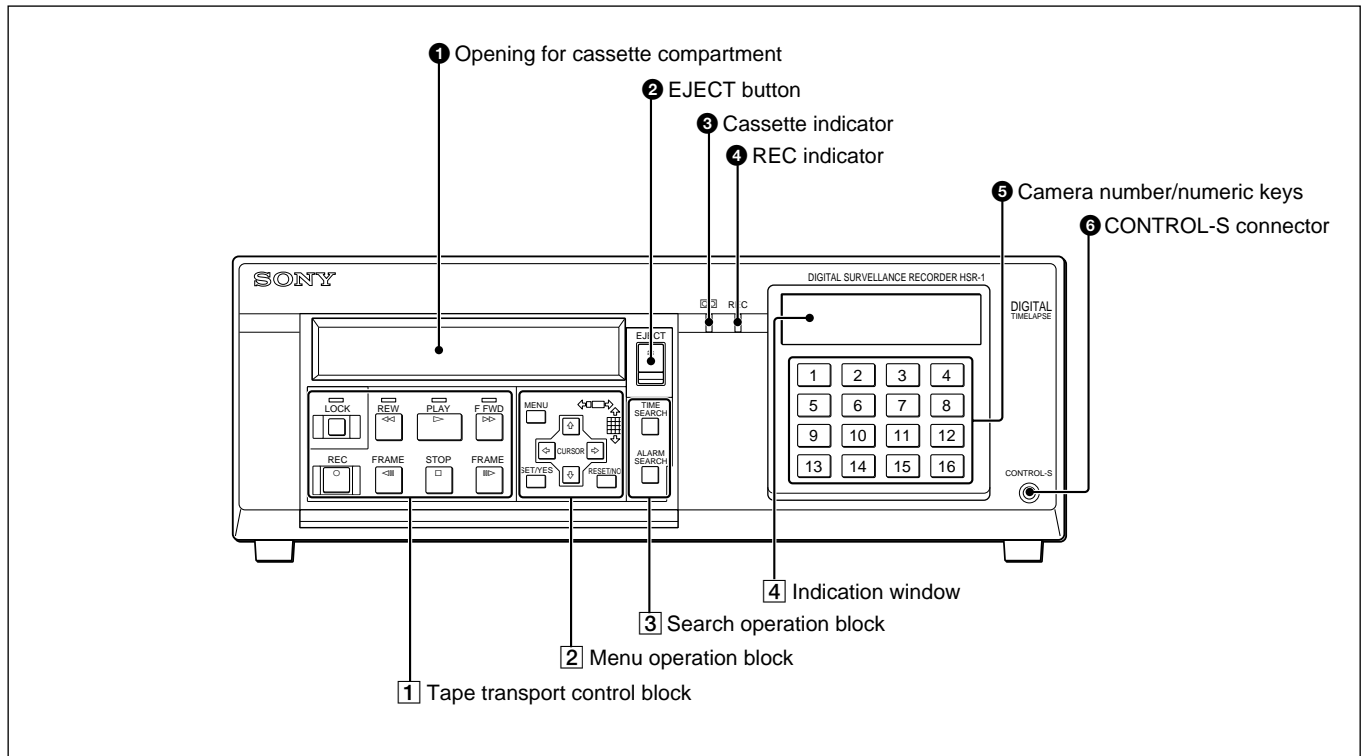

1 Opening for cassette compartment

Insert a DV-format cassette of standard or mini size. When inserting a mini-sized cassette, locate it in the center of the opening.

For compatible cassettes, see “Handling Cassettes” on page 2-1.

2 EJECT button

Press to eject the cassette.

3 Cassette indicator (green)

Lights when a cassette is loaded. It flashes while the cassette is being ejected.

4 REC (recording) indicator (red)

Lit during recording.

5 Camera number/numeric keys

Flash or light in green or amber depending on the conditions.

When monitoring and playback, they function as the keys for camera selection.

In menu operations or when releasing the key lock, they function as the numeric keys for entering numeric values or the password.

	monitor	playback	menu operation
Off	Disabled ¹⁾	No image recorded ²⁾	Not operable
Green	Available for monitor ³⁾	Available for playback	Numeric inputs valid
Amber	being monitored ⁴⁾	being played	–

- 1) The key for any camera set to NO for Camera Connection of the Image Control menu (page 5-6) does not light.
- 2) The key for any camera which has been set to NO REC on the Rec Function menu (page 5-11) when recording was made does not light.
- 3) The key for any camera for which no signal is being supplied flashes in a slow cycle.
- 4) The key for any camera whose signal is being displayed on a full screen flashes in a fast cycle.

6 CONTROL-S (S control input) connector (stereo mini jack)

By connecting a controller, such as the SVRM-100A, equipped with an S control output to this connector, tape transport on this recorder can be remotely controlled.

1 Tape transport control block

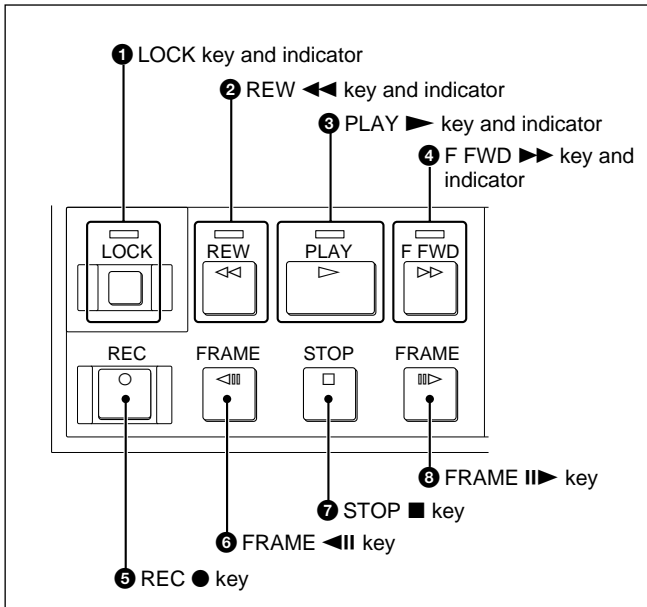

1 LOCK key and indicator

Press this key to turn on/off the key-lock function (provided to prevent misoperation). The LED indicator (red) lights when the function is on. When this indicator is lit, other keys are disabled. To release the lock, press the LOCK key again. A four-digit password to release the lock can be specified by using the Function Control menu. For details, see “Setting Passwords” on page 5-14.

2 REW ◀◀ (rewind) key and indicator

Press this key to rewind the tape. The LED indicator (green) lights. This key functions as the reverse search key during playback.

3 PLAY ▶ key and indicator

Press this key to start playback. The LED indicator (green) lights.

4 F FWD ▶▶ (fast forward) key and indicator

Press this key to fast-forward the tape. The LED indicator (green) lights. This key functions as the forward search key during playback.

5 REC ● (record) key

Press this key to start recording.

6 FRAME ◀|| key

Press this key to reverse the picture by one frame.

7 STOP ■ key

Press this key to stop the tape transport.

8 FRAME ||▶ key

Press this key to advance the picture by one frame.

2 Menu operation block

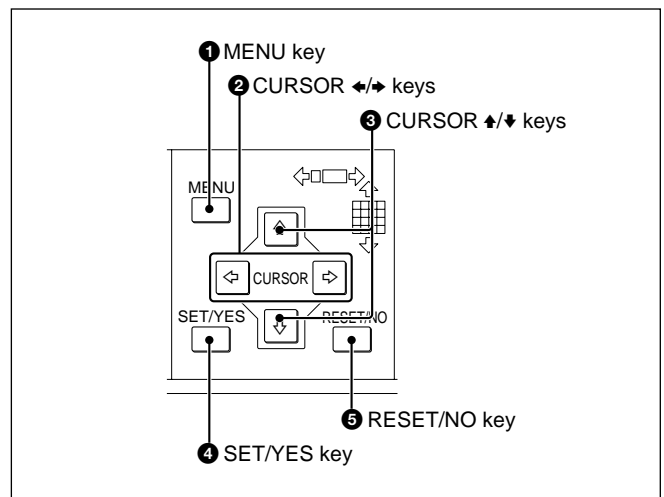

1 MENU key

Press this key to enter Menu mode. Press again to exit the mode.

2 CURSOR ◀/▶ keys

Used to move from one layer to another in Menu mode.

While monitoring a picture, you can switch pages (different camera configuration with the same screen divisions) with these keys.

3 CURSOR ▲/▼ keys

Used to move within a single layer in Menu mode. While monitoring a picture, you can switch screen division configurations with these keys.

4 SET/YES key

Press this key to register your menu settings. This key also functions as the YES answer key for YES/NO questions.

Locations and Functions of Parts

5 RESET/NO key

In normal operation mode, press this key to reset the tape counter value in the indication window.

In menu mode, this key functions as the NO answer key for YES/NO questions.

3 Search operation block

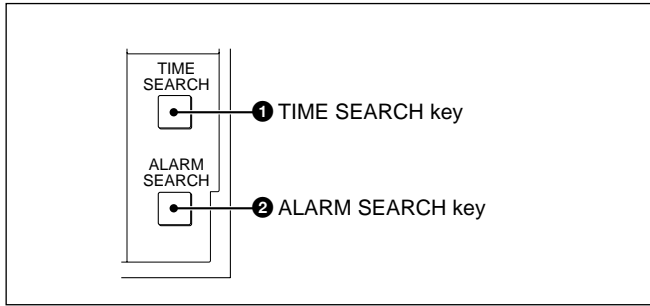

1 TIME SEARCH key

To transport the tape to the point of recording at a specified date and time.

For details, see “Time Search” on page 2-10.

2 ALARM SEARCH key

To display the list of alarm recordings on a tape and transport the tape to the point of the specified recording.

For details, see “Alarm Search” on page 3-10.

4 Indication window

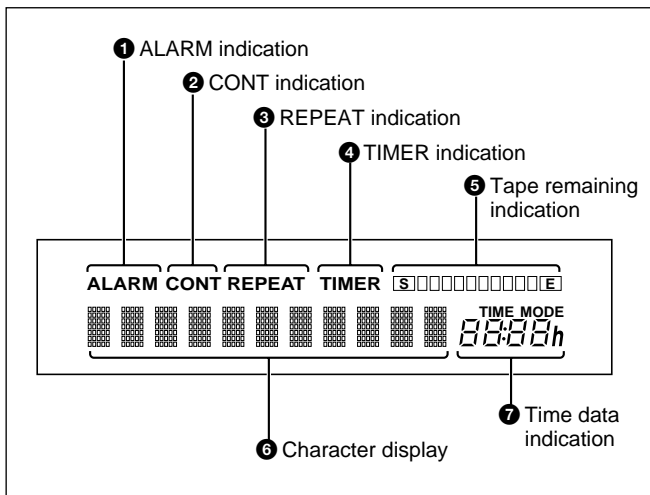

1 ALARM indication

Lights when alarm recording is on.

For details, see “Alarm Recording” on page 3-4.

2 CONT (continuous) indication

Lights during continuous recording.

For details, see “Continuous Recording” on page 3-8.

3 REPEAT indication

Lights during repeat recording.

For details, see “Repeat Recording” on page 3-7.

4 TIMER indication

Lights when the timer recording is on.

For details, see “Timer Recording” on page 3-1.

5 Tape remaining indication

Lights when a cassette is loaded, showing the recording capacity remaining on the tape.

The remaining segment(s) will flash when the remaining recording capacity becomes less than 3 minutes based on the calculation from the Tape Length setting.

For the Tape Length setting, see “Setting the Recording Modes” on page 5-11.

6 Character display

Shows character data, such as the tape counter value and menu items.

The tape counter value is a relative time (hours, minutes, seconds), which has the following meaning according to the mode of this recorder:

In playback mode: The tape position where the video information being output has been recorded.

In recording mode: The tape position where the current video information is recorded.

In other modes: The current tape position

Note

As the recorder employs a hybrid configuration of HDD and tape, the counter value being displayed in playback may considerably differ from the actual tape position. Therefore, the tape counter value may jump when you change the operation from PLAY to F.FWD/REW mode.

7 Time data indication

Shows the time to record on a single tape (Time mode) in hour units.

By setting “Front Time Disp” on the Indication Control menu (page 4-8), the tape remaining time for recording or current time can also be displayed in this section.

Rear Panel

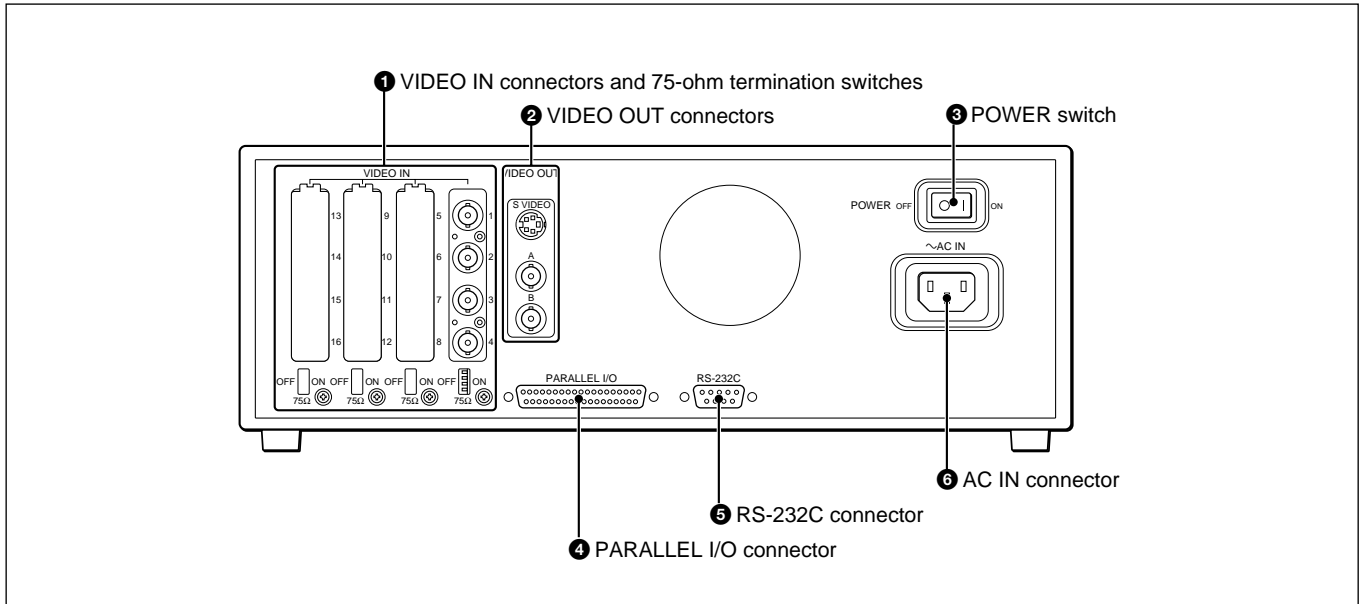

❶ VIDEO IN (video input) connectors (BNC type) and 75-ohm termination switches

For connecting video cameras.

Connectors 1 to 4 are provided as the standard inputs. Connectors 5 to 16 can be added, four additionally connectors for each optional HSRA-11 input board mounted.

The termination switches are normally used in the ON position.

For mounting an input board, see the instruction manual for the HSRA-11.

❷ VIDEO OUT (video output) connectors S VIDEO (luminance/chroma signal output) connector (4-pin):

Outputs Y/C-separated S video signals. Connect via a cable to the S video input of a video monitor.

A (A image output) connector (BNC type): Outputs composite video signals for monitoring. Character signals are superimposed on the output signal depending on the settings made on the Indication Control menu (page 4-8).

B (B image output) connector (BNC type): Outputs composite video signals. The signal to be output is normally the same as that from the A connector. The Image Control menu (page 4-6) permits you to specify use of this output exclusively for a specific camera. Note that the character signal is not superimposed with such usage.

❸ POWER switch

For turning on/off the power to the recorder.

❹ PARALLEL I/O connector (37-pin)

Used to input/output various control signals or to supply control voltages.

You can use 24 pins for inputs and 8 pins for outputs. The functions of these pins can be assigned from the Remote Control menu (page 4-13).

❺ RS-232C connector (9-pin)

Connect an editor or computer, via an RS-232C cable.

❻ AC IN connector

Connect an AC power source via the supplied AC power cord.

Screen Displays

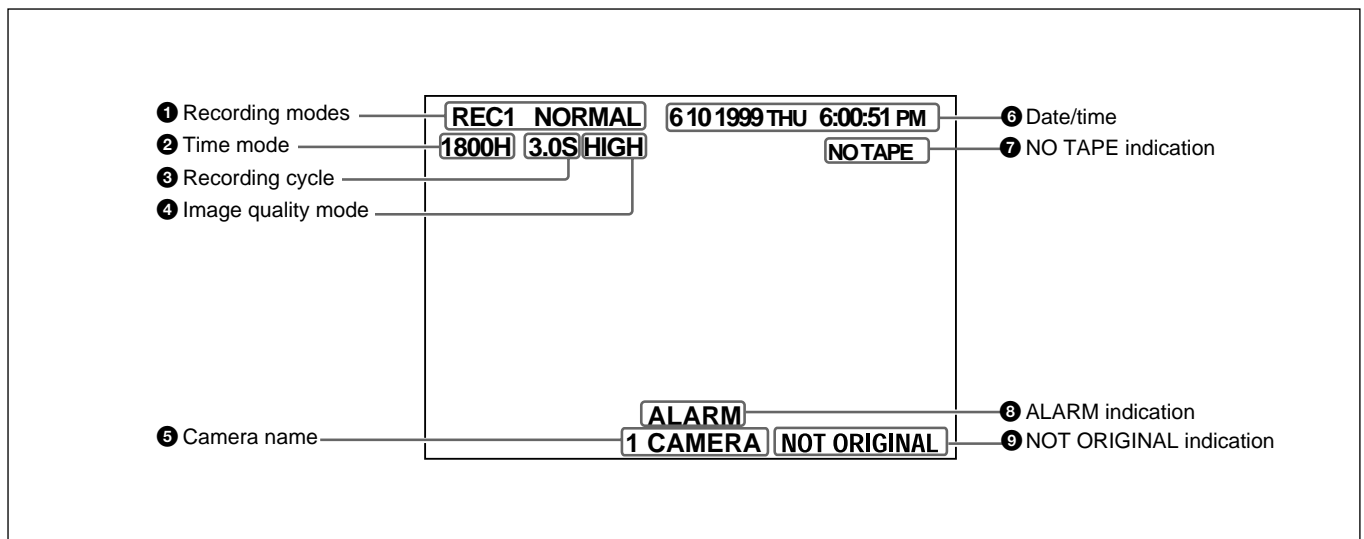

1 Recording modes

When recording or monitoring, the currently selected mode and recording mode number (REC1 to REC5) are displayed.

NORMAL: Normal recording

TIMER: Timer recording

ALARM: Alarm recording in Normal mode

INT-A: Alarm recording in Interleave mode

PRE-A: Alarm recording in Prealarm mode

EVT-A: Alarm recording in Event mode

FRM-A: Alarm recording in Frame mode

These items are not displayed during playback.

Whether to display them can be set on the Indication Control menu.

2 Time mode

When recording or monitoring, the currently selected Time mode is displayed.

Whether to display it can be set on the Indication Control menu.

3 Recording cycle

When recording or monitoring, the currently selected Recording cycle is displayed.

During playback, that used for recording is displayed.

Whether to display it can be set on the Indication Control menu.

4 Image quality mode

When recording or monitoring, the currently selected Image quality mode is displayed.

During playback, that used for recording is displayed.

Whether to display them can be set on the Indication Control menu.

5 Camera name

When recording or monitoring, the name specified for the current camera is displayed.

During playback, the camera name recorded on the tape is displayed.

The names of the cameras and whether to display them can be set on the Indication Control menu.

6 Date/time

When recording or monitoring, the current date and time are displayed.

During playback, the date and time when the picture was recorded are displayed.

Whether to display them and the display format can be set on the Indication Control menu.

For the Indication Control Menu, see Chapter 4 “Menu Operations.”

7 NO TAPE indication

If no tape is loaded in the recorder when some information that has not been recorded on a tape remains on the HDD, a “NO TAPE” indication flashes.

For details, see “HDD Recording/Playback” on page 3-11.

⑧ ALARM indication

If there is an external alarm input, an “ALARM” indication is superimposed. As this information is recorded on the tape, the indication is also obtained in playback.

⑨ NOT ORIGINAL indication

Thanks to the original watermark system, a “NOT ORIGINAL” indication is superimposed, if the image being played may have been artificially altered. This indication can be seen only in Still mode (either FRAME key pressed) with the full-screen display.

Note

This indication is disabled in alarm recording in FRAME mode or when you switch the unit from high-speed playback to variable playback.

Basic Operations

Handling Cassettes

Usable Cassettes

The following standard- and mini-sized cassettes of DV-format can be used with this recorder.

Model name	Size
DV-120ME/180ME/270ME, PDV-64N/124N/184N	Standard
DVM-30ME/60ME, PDVM-32N/40N	Mini

The number included in the name of a DV- or DVM-series model indicates the tape length (unit: minute). (Ex.: 270 minutes with DV-270ME).

In case of a PDV- or PDVM-series model, the value obtained by multiplying the number included in the name by 1.5 corresponds the tape length (unit: minute). (Ex.: 276 minutes with PDV-184N).

Notes on usage

- When a cassette is to be stored for a long time, rewind the tape to the beginning, mount it in the original case, and place it vertically. Leaving a cassette lying flat may cause noisy pictures.
- If any undue force is applied to the cassette, such as by dropping it, the tape may become slackened, causing abnormal recording/playback. Before using a cassette, be sure to check that the tape is not slacked.

To check the tape slack

Gently turn the reel in the direction of the arrow using a paper clip or equivalent. If there is no slack, the reel will not rotate. Then, insert the cassette in the recorder and remove it after about 10 seconds.

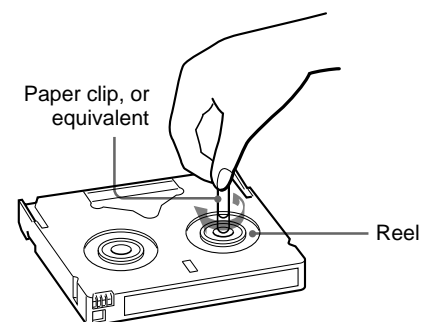

Handling Cassettes

To prevent unintentional erasure

Set the REC/SAVE switch to the SAVE position.

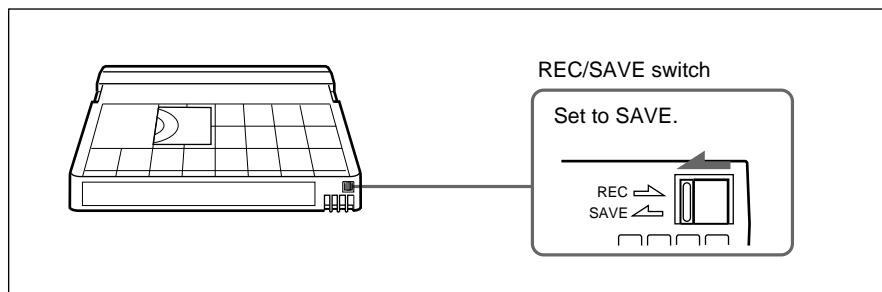

To rerecord on a cassette

Return the REC/SAVE switch to the REC position. No recording will be made on a cassette with the switch set to SAVE.

Inserting a Cassette

Insert/eject a cassette with the power on.

Open the front panel cover and insert the cassette through the opening as shown below.

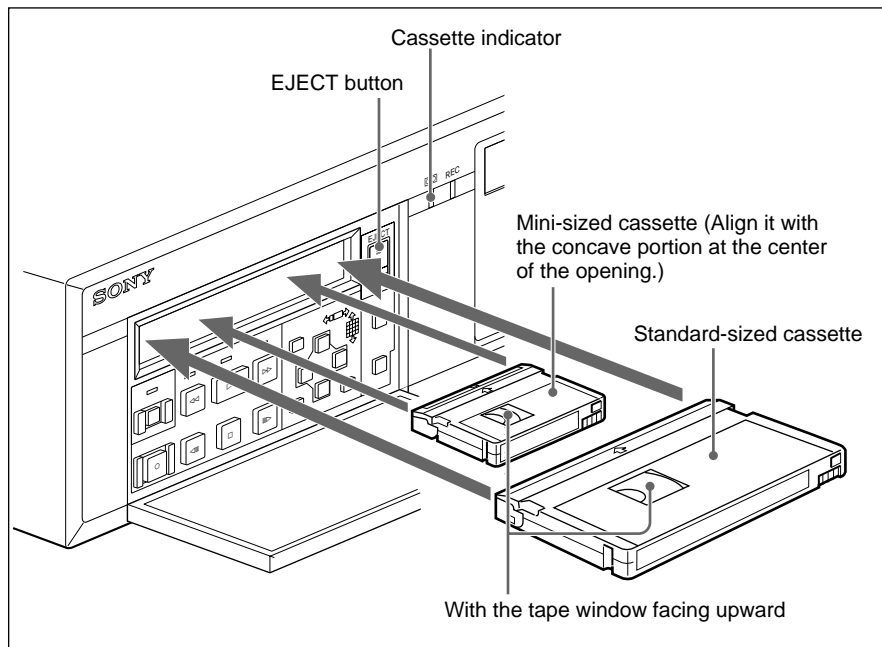

The cassette is automatically pulled into the operating position and the cassette indicator lights up.

Ejecting a Cassette

Press the EJECT button.

The cassette indicator flashes while the cassette is being ejected.

Monitoring Picture

Dividing the Screen

In addition to the capability to show the picture from a specified camera on the full screen, this recorder has a multiplexer function to divide the screen into multiple divisions and permit you to view the pictures from multiple cameras at a glance.

In screen division modes, you can select the respective number of pages (the same divisions with different camera configurations) for monitoring. The following camera numbers have been assigned at the factory.

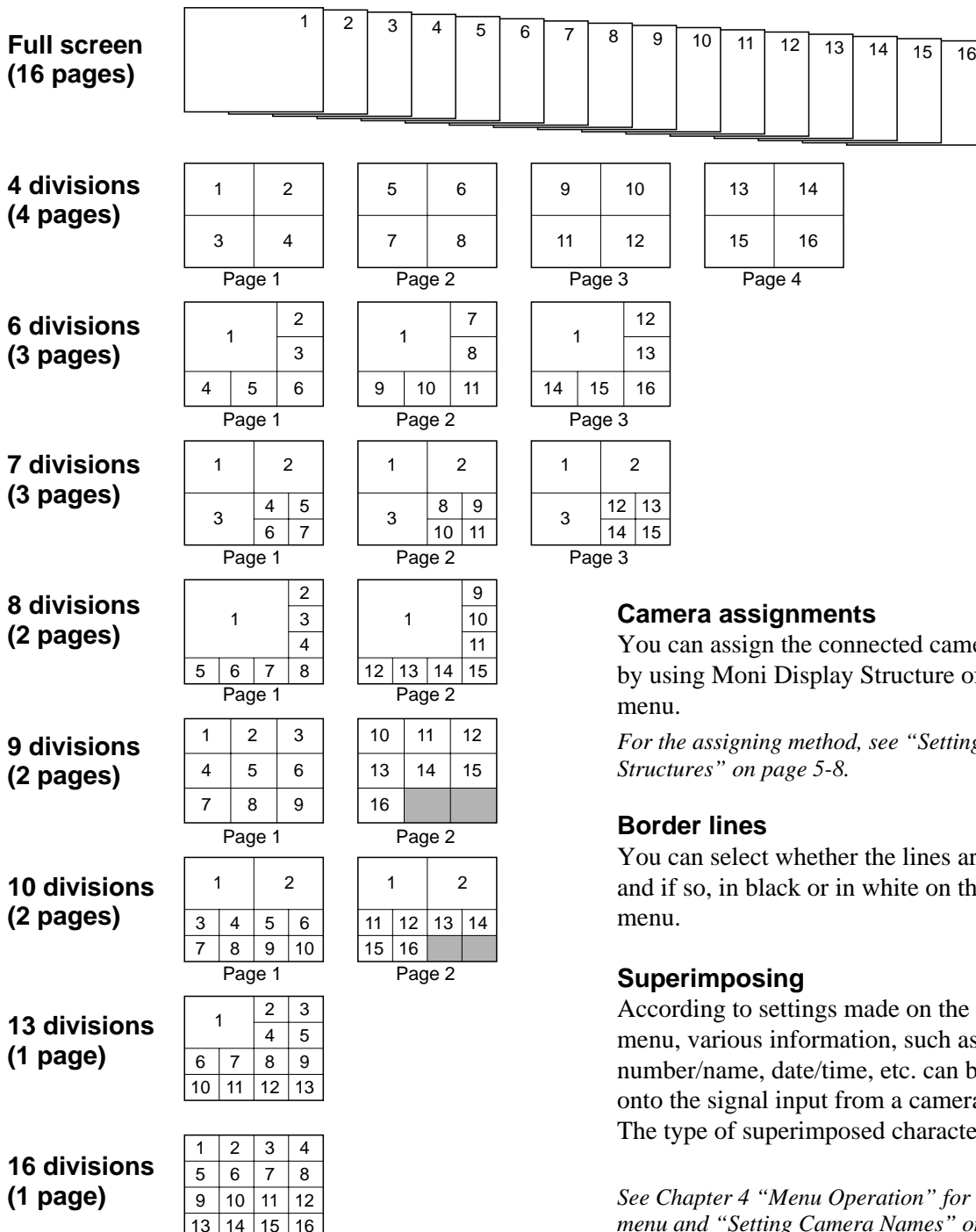

Camera assignments

You can assign the connected cameras to any division by using Moni Display Structure of the Image Control menu.

For the assigning method, see "Setting the Display Structures" on page 5-8.

Border lines

You can select whether the lines are to be displayed, and if so, in black or in white on the Indication Control menu.

Superimposing

According to settings made on the Indication Control menu, various information, such as the camera number/name, date/time, etc. can be superimposed onto the signal input from a camera.

The type of superimposed characters can also be set.

See Chapter 4 "Menu Operation" for the Indication Control menu and "Setting Camera Names" on page 5-7 for camera names.

Monitoring Picture

Switching the Pictures

The number keys of the cameras whose pictures can be monitored flash in green.

To select the picture(s) for monitoring, use the flashing camera number keys or the CURSOR \uparrow / \downarrow / \leftarrow / \rightarrow keys.

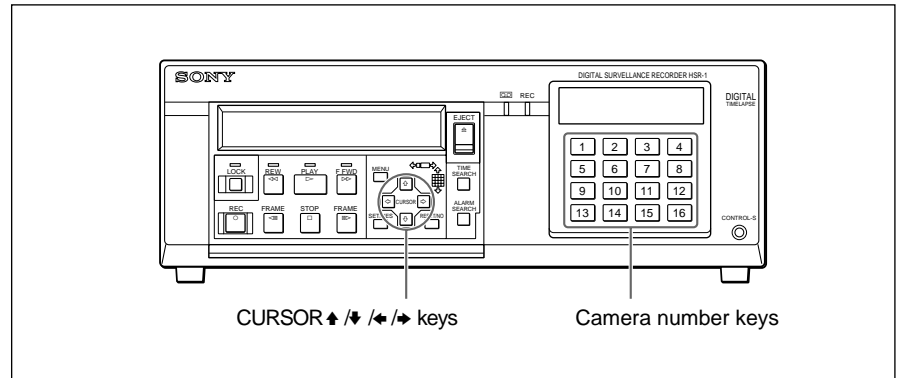

For connections and Image Control menu operation, see Chapter 5 “Connections and Preparations.”

To select a specific camera

Press the number key corresponding to the camera to be monitored. The key then flashes in amber, and the picture of the selected camera is displayed on the full screen.

Press the same key again to return to the previous condition.

To select a divided screen

Multiple camera pictures can be monitored by selecting the screen division mode.

To change the structure

Press the \uparrow or \downarrow key.

Each time you press either of the keys, the display switches to the next of night patterns, from the full screen to 16-division mode.

To change the pages

Press the \leftarrow or \rightarrow key.

The pages are cyclically switched.

To automatically switch pages

The pages of the structure selected using the \uparrow or \downarrow key are automatically switched at the cycle specified in the range of 1 to 60 seconds.

Set MONITOR to AUTO on the Image Control menu.

For the settings, see Chapter 5 “Connections and Preparations.”

Normal Recording

About the recording modes

Up to five user-preset recording modes can be registered to this recorder. You may specify a set of recording requirements to each recording mode. Once the recording modes are set, the specified requirements for recording are set merely by selecting one of your preset recording modes.

Example of setting a user-preset recording mode:

CAMERA NUMBER : 8
TAPE LENGTH: 270MIN
IMAGE QUALITY: SUPER
TIME MODE: 33H
REC CYCLE: 1.00SEC

When recording is executed with the example recording mode selected, pictures from all eight cameras that have been specified to be used for recording (set to REC) are cyclically recorded once per 1.00 second in SUPER image quality mode (horizontal 720 × vertical 240 pixels) for 33 hours on a single cassette of 270-minute tape length.

Recording modes can be registered by using “Setting of Rec Mode” of the Recording Function menu.

For registering the recording modes, see Chapter 5.

To select a recording mode

A recording mode for normal recording can be selected on the monitor screen or on the character display on the front panel. Once you select a mode, it is not necessary to select the mode again unless it needs to be changed.

See Chapter 4 “Menu Operations” for additional information on the operation.

- 1 Enter Menu mode by pressing the MENU key.
- 2 Highlight REC FUNCTION MENU (or display “RecFuncMenu” on the front panel) of the Top menu (page 4-5) by pressing the \uparrow or \downarrow key, then press the \rightarrow key.

The Recording Function menu is displayed.

```
          SETUP MENU
REC FUNCTION MENU
NORMAL REC      : MODE 1
TIMER REC
ALARM REC
REPEAT REC      : OFF
CONTINUOUS REC  : OFF
SETTING OF REC MODE
```

Recording

The Recording Function menu item that had been selected when you left the menu the last time is displayed in the character display on the front panel.

- 3 Highlight NORMAL REC (or display “RecMode”) by pressing the \uparrow or \downarrow key, then press the \rightarrow key.

The menu switches to the recording mode selection layer for normal recording.

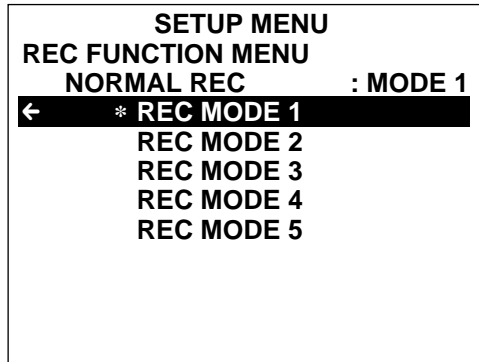

- 4 Highlight the desired recording mode, REC MODE 1 to 5 (or display Mode 1 to 5) by pressing the \uparrow or \downarrow key, then press the SET key. A message “NOW SAVING” is displayed, and the selection is registered.

To execute recording

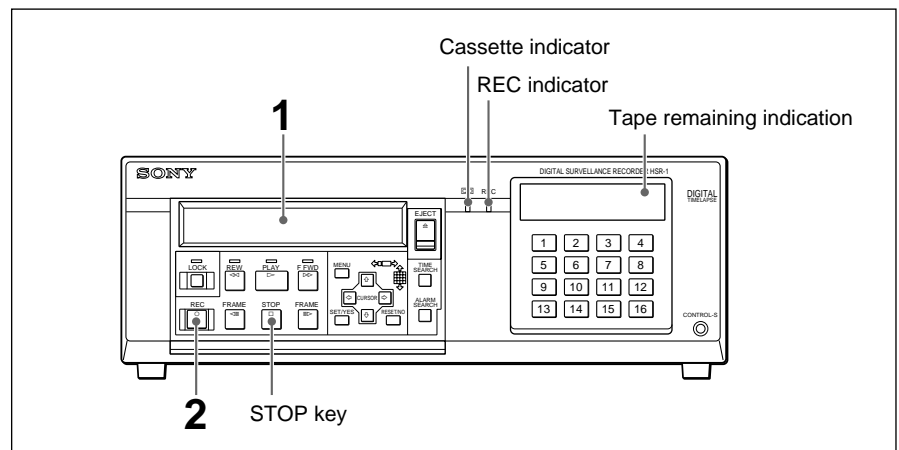

- 1 Insert a cassette.
The cassette indicator and the tape remaining indication light.
- 2 Press the REC key.
The REC indicator lights, and recording starts in the selected recording mode.

When the remaining tape capacity becomes less than 3 minutes during recording, the tape remaining indication flashes.
When the tape reaches the end, recording stops.

To stop recording before the end of a tape

Press the STOP key.

Notes

- When you press the STOP key, the unit starts recording data remaining on the hard disk to the cassette tape. This operation may take 90 seconds at maximum, and you cannot change modes until it is completed. During this operation, the remaining time until mode shift is enabled is displayed on the monitor screen and the character display of the HSR-1/1P.
- Some images recorded on the beginning of a tape may not be played. The duration that cannot be played depends on the recording cycle, the number of cameras, and the image-quality mode.

Example With a 1-second recording cycle, eight cameras, HIGH mode:
approx. 3 seconds

With alarm recording in FRAME mode: approx. 6 frames

- If very few picture frames have been recorded continuously, time search and alarm search may fail, or the pictures may not be played correctly. It is therefore recommended to perform recording for a certain duration continuously. The recording duration required for correct playback depends on the recording cycle, the number of cameras, and the image quality mode.

Example With a 1-second recording cycle, eight cameras, HIGH mode:
approx. 10 seconds or more

As continuously recorded duration is short in EVENT- or PREALARM-mode alarm recording, it is especially recommended to specify as a short recording cycle as possible.

Data recording

The HSR-1/1P records the following information as data along with the video signals.

The recorded data can be superimposed on the playback picture by so specifying on the Indication Control menu (page 4-8).

Camera names

The names specified for the cameras used for recording (up to 12 characters each) are recorded.

The default names are “1 CAMERA” to “16 CAMERA,” which can be changed from the Indication Control menu.

For details, see “Setting Camera Names” on page 5-7.

Recording mode/Time mode/Recording cycle/Image quality mode

Recording mode, Time mode, Recording cycle, and Image quality mode used for recording are recorded.

Date/Time

The date and time of recording are recorded.

Recording

The camera number, date and time of recording can also be recorded as image on the tape. The data recorded as image are always be superimposed on the playback picture.

Whether to record the data as image is set on the Indication Control menu (page 4-8), which is set at the factory to record.

The superimposing position of the date and time can also be set on the Indication Control menu.

Normal Playback

The tape recorded on this recorder is played back in accordance with the mode set for recording.

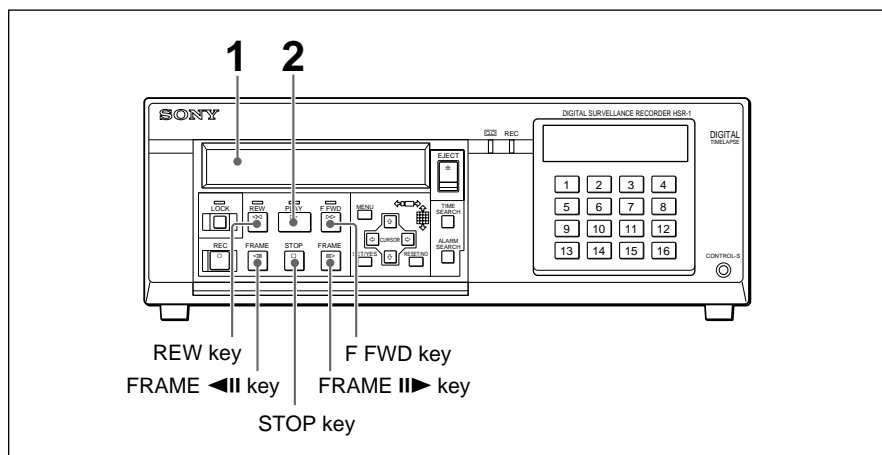

1 Insert the recorded cassette.

2 Press the PLAY key.

Playback begins.

The date/time, if recorded as image, are superimposed on the playback picture.

Whether to superimpose the name of the camera, recording mode, time mode, recording cycle, and image quality mode used in recording and the date/time recorded as data can be set on the Indication Control menu (page 4-8).

To advance the picture at a high speed

Press and hold the F FWD key.

Normal playback is resumed when you release the key.

To reverse the picture at a high speed

Press and hold the REW key.

Normal playback is resumed when you release the key.

To advance the picture by one frame

Press the FRAME ▶ key.

The picture freezes at the next frame.

To resume normal playback, press the PLAY key.

To reverse the picture by one frame

Press the FRAME ◀ key.

The picture freezes at the previous frame.

To resume normal playback, press the PLAY key.

To stop playback

Press the STOP key.

Search speed

The maximum search speed depends on Recording mode which was specified for recording.

The fewer cameras for recording, the longer the recording cycle, and the lower the image quality mode, the higher the speed at which you can monitor the playback picture.

Note

Search in the reverse direction uses data in the hard disk. Therefore, you cannot search for pictures which are not stored in the hard disk (i.e. pictures recorded before the playback start point). When search in the reverse direction passes the playback start point, the message “No playback data” is displayed.

To search for a picture before the playback start point, once stop the tape, rewind it, then restart the playback.

Dividing structure of the playback screen

In the same manner as when monitoring, the screen can be divided into 16 divisions at maximum, and you can assign a camera to each division as desired.

The camera assignment for playback can be made independent from that for monitoring.

See “Monitoring Picture” (page 2-3) for the screen dividing structures, and Chapter 5 “Connections and Preparations” for the camera assignment.

Monitoring the playback picture and the current camera inputs simultaneously

You can assign live camera inputs to some divisions of the playback screen.

You can view the current picture of the assigned camera in addition to the playback pictures.

Time Search

Using the date/time data recorded on a tape, you can locate the picture for any specified date and time.

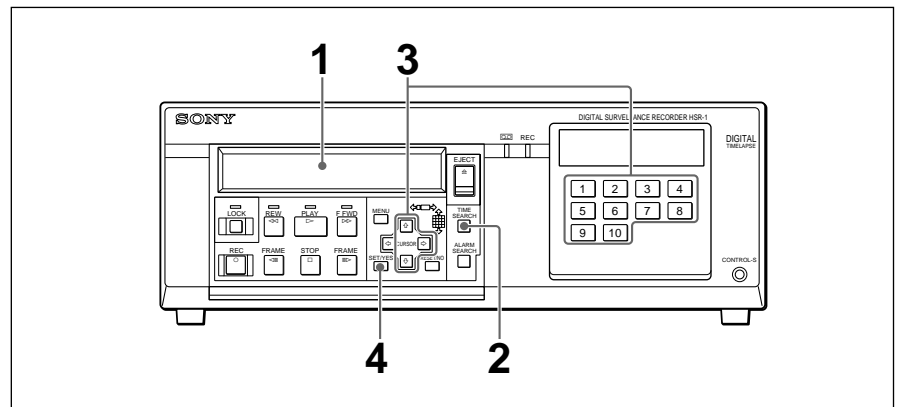

- 1 Insert the recorded cassette.
- 2 Press the TIME SEARCH key.

The Time Search display appears on the monitor screen.

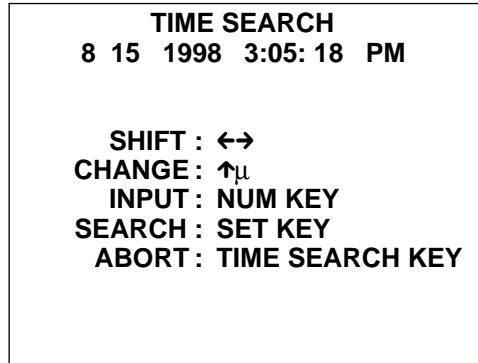

- 3 Shifting the input position using the ► key, set the date and time.

The date (year/month/day) and time (hour/minute/second) can be set by either changing the value in turn using the ▲ or ▼ key or by directly entering the value using the numeric keys.

Press the ▲ or ▼ key to switch between AM and PM.

- 4 Press the SET key.

The tape rewinds or fast-forwards, searching for the tape position of the specified date/time.

When the search is completed, the picture of that position is displayed in still mode.

To cancel the time search

- While entering the date/time, press the TIME SEARCH key again.
- While the tape is running, press the STOP key.

Convenient Recording/ Playback Functions

Timer Recording

You can set the recorder to start recording or change recording modes at a specified time of day. By changing recording modes, you can use different cameras for recording in different time slots, or record at a certain cycle in the daytime and record only when an alarm signal is detected at night.

The time as well as the recording mode (1 to 5) must be specified.

To set the timer

Timer setting is made on a special display on the monitor screen.

Once you set the timer, it is not necessary to repeatedly set it if it is not to be changed.

See Chapter 4 "Menu Operations" for additional information.

- 1** Enter Menu mode by pressing the MENU key.
- 2** Highlight REC FUNCTION MENU of the top menu (page 4-5) by pressing the **▲** or **▼** key, then press the **▶** key.

The Recording Function menu is displayed.

```
          SETUP MENU
REC FUNCTION MENU
NORMAL REC      : MODE 1
TIMER REC
ALARM REC
REPEAT REC      : OFF
CONTINUOUS REC  : OFF
SETTING OF REC MODE
```

Timer Recording

- 3** Highlight **TIMER REC** by pressing the **▲** or **▼** key, then press the **▶** key.

The menu shifts to the selection layer of timer recording.

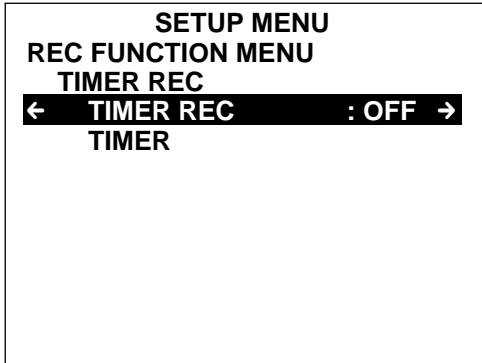

- 4** Highlight **TIMER SET** by pressing the **▲** or **▼** key, then press the **▶** key.

The **TIMER** set display appears on the monitor screen and the indication at the upper left flashes.

TIMER set display

		TIMER			
DAY	TIME	REC	TIME	REC	
Mo	0:00AM	1,	5:00PM	2	
Tu	0:00AM	1,	5:00PM	2	
We	0:00AM	1,	5:00PM	2	
Th	0:00AM	1,	5:00PM	2	
Fr	0:00AM	1,	5:00PM	0	
Sa	-: -	-,	-: -	-	
Su	-: -	-,	-: -	-	

TIME MODE=1900HOURS

- 5** Set the day(s) by pressing the **▲** or **▼** key.

Mon-Fr: To operate at the same setting from Monday to Friday.

Everyday: To operate at the same setting everyday.

- 6** Set the time and the recording mode number by pressing the **▲** or **▼** key in the sequence then move to the next digit or item by pressing the **▶** key.

- By specifying another set of time and recording mode in the right column, recording is continued after changing the recording mode at the time specified in the right column.

- If recording mode need not to be changed, delete the time by pressing the **RESET** key. When the time is deleted, “—” is displayed.
- Time Mode is automatically calculated and displayed according to the selected recording mode.
- To stop recording at the specified time, set 0 in the REC column.
- When you set “A” in the REC column, alarm recording will start at the specified time. This alarm recording is performed in the mode set on the alarm set display (page 3-5).

- 7** Perform the same settings for each day of the week when required.

For the day which recording is not necessary, delete the day or time by pressing the **RESET** key.

- 8** When the settings are completed, press the **SET** key.

A message “NOW SAVING” is displayed and the settings are stored in nonvolatile memory.

Notes

- The time mode shown on the **TIMER** set display suggests the timing for changing the cassette tape next after starting recording at 0:00 AM on Monday. That is, if “TIME MODE=178HOURS” is shown, you may change the tape by 10:00 AM on the next Monday. However, recording is not always started at 0:00 AM on Monday, so the time mode may not indicate the precise time. The difference will be large especially when the time mode value is small.
- If the calculated time mode exceeds 9999 hours, “****” is displayed.
- When “A” is set in the REC column, “****” is displayed for TIME MODE, as the time mode cannot be calculated.
- When **ALARM REC** is set to **ON** on the recording function menu (page 3-6), alarm recording will be activated regardless of the timer recording setting.

To activate timer recording

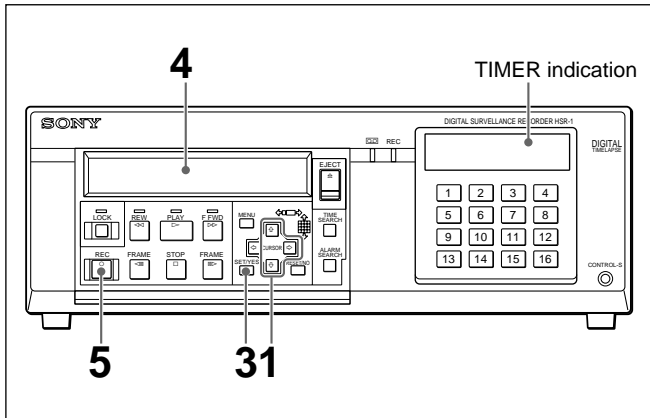

- 1 Highlight **TIMER REC** on the display shown in step 3 on the previous page by pressing the **▲** or **▼** key, then press the **▶** key.
The menu shifts to timer recording selection.

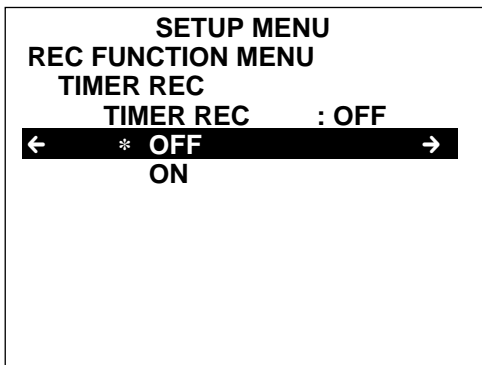

- 2 Highlight **ON** by pressing the **▲** or **▼** key, then press the **▶** key.
- 3 Press the **SET** key to leave Menu mode.
- 4 Insert a cassette.
- 5 Press the **REC** key.

The **TIMER** indication of the indication window lights, and the timer recording selected in step 2 will be activated.

To cancel timer recording

To stop recording in progress

Press the **STOP** key.

To cancel timer recording

Return the **TIMER REC** setting to **OFF** on the display in step 1.

If there is recording in progress, it will be continued.

Alarm Recording

You can set the recorder to start recording or change the recording mode when an alarm signal is input to the PARALLEL I/O connector at the rear panel.

For the alarm signals, you can specify a signal common to all cameras or signals for specific cameras.

The signal assignments are made from the Remote Control menu (page 4-13).

Alarm recording modes

The recorder provides five modes of Alarm recording. For alarm recording, you may set the recording mode for alarm recording and a condition for canceling alarm recording.

The items to be set depend on the Alarm recording modes.

NORMAL mode

When an alarm signal is input during recording, the recording mode is changed.

You can set the recording mode for alarm recording and Cancel condition.

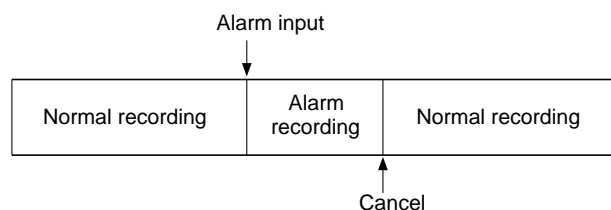

If an alarm signal for a specific camera is input, recording with other cameras is stopped and only the picture from the camera in alarm status is recorded in the image quality mode and recording cycle of the recording mode specified for alarm recording.

INTERLEAVE mode

When an alarm signal is input, recording cycle is shortened.

As with Normal mode, you can set the recording mode for alarm recording and Cancel condition.

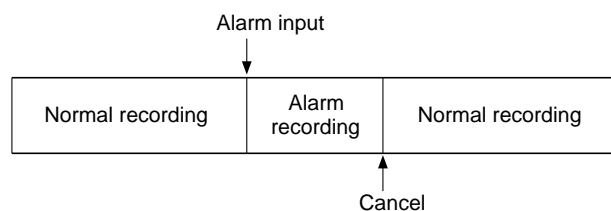

When an alarm signal common to all cameras is input, this mode functions the same as Normal mode.

When an alarm signal for a specific camera is input, only the recording cycle for the camera in alarm status

is shortened. (Recording time will not change as the recording cycle for other cameras is prolonged.)

Example:

- Normal recording:
Records camera 1 → camera 2 → camera 3 → ... camera n → camera 1, and so on.
- If an alarm signal for camera 1 is input:
Records camera 1 → camera 2 → camera 1 → camera 3 → ... camera n → camera 1, and so on.

Note

Interleave mode is valid only when the recording cycle is more than “the number of cameras × 0.1 second” (NTSC model) or “the number of cameras × 0.12 seconds” (PAL model). If any shorter recording cycle has been specified, the recording cycle for the camera in alarm status will not be changed.

Example: To activate alarm recording in Interleave mode using ten cameras for recording, set the recording cycle to 1 second (NTSC model) or 1.2 seconds (PAL model) or longer.

EVENT mode

Recording starts when an alarm signal is input.

You can set the recording mode for alarm recording and Cancel condition.

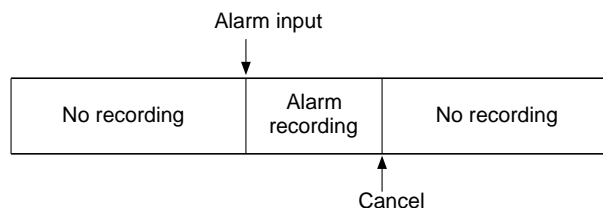

When an alarm signal for a specific camera is input, only the picture from the camera in alarm status is recorded for alarm recording.

PREALARM mode

Recording starts tracing the specified time back.

You can set the recording mode for alarm recording, Prealarm Time (time to reverse) and Cancel condition.

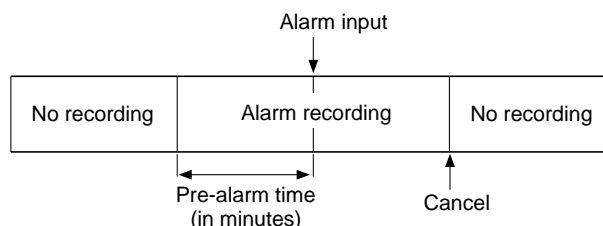

As you can record the picture from the hard disk taken before the alarm was generated, it may be helpful in finding the cause of the trouble.

FRAME mode

When an alarm signal for a specific camera is input, the picture of the camera in alarm status is recorded only for one frame immediately after the alarm input. The recording mode for alarm recording is fixed to HYPER (the highest image quality mode exclusive for this FRAME mode), and Cancel condition to 1 frame. In this case, the maximum recording cycle is about 4 frames per second.

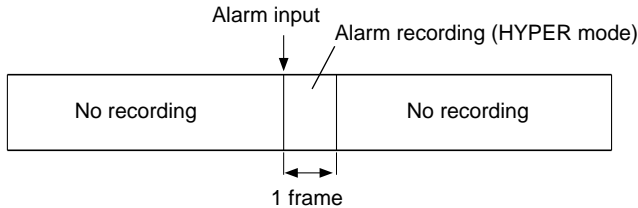

Note

Any alarm input in FRAME mode is not registered to the alarm list.

Cancel condition of Alarm recording

For alarm recording other than Frame mode, you can select the condition to cancel recording from among the following.

- 30SEC, 1MIN, 2MIN, 3MIN, 5MIN, 7MIN, 10MIN: The specified time has elapsed.
- ALM OFF: The alarm input stops.
- TAPE END: Recording reaches the end of the tape.

To set the Alarm mode

The setting is made on a special display on the monitor screen.

Once you set the mode, it is not necessary to repeatedly set it if it is not to be changed.

See Chapter 4 "Menu Operations" for additional information.

- 1** Enter Menu mode by pressing the MENU key.
- 2** Highlight REC FUNCTION MENU of the Top menu (page 4-5) by pressing the \uparrow or \downarrow key, then press the \rightarrow key.

The Recording Function menu is displayed.

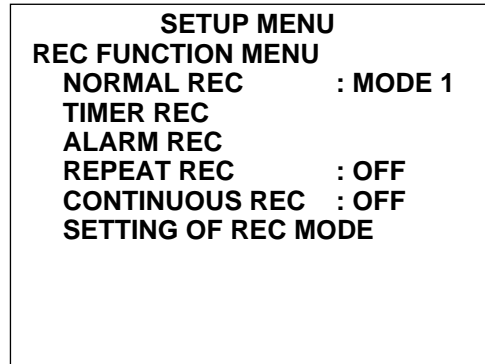

- 3** Highlight ALARM REC by pressing the \uparrow or \downarrow key, then press the \rightarrow key.

The menu shifts to the selection layer of alarm recording.

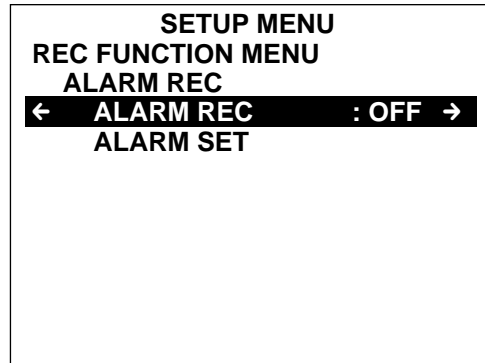

- 4** Highlight ALARM SET by pressing the \uparrow or \downarrow key, then press the \rightarrow key.

The alarm set display appears on the monitor screen.

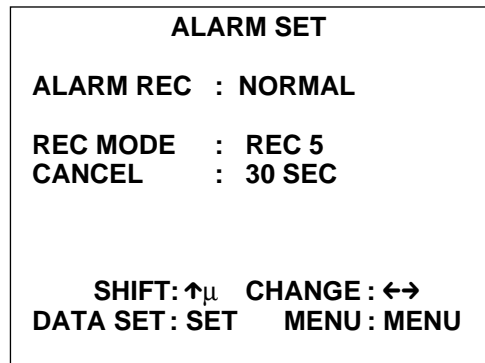

- 5** Select the desired Alarm REC mode by pressing the \uparrow or \downarrow key, then press the \rightarrow key.

(Continued)

Alarm Recording

- 6** Specify the items required for the selected Alarm recording mode.
For NORMAL/INTERLEAVE/EVENT mode: Recording mode for alarm recording and Cancel condition
For PREALARM mode: Recording mode for alarm recording, Prealarm time and Cancel condition
Press the **▲** or **▼** key to set, then press the **▶** key to go to the next item.

No setting is required for FRAME mode.

- 7** When the settings are completed, press the SET key.

A message “NOW SAVING” is displayed, and the settings are stored in nonvolatile memory. The Recording Function menu is resumed.

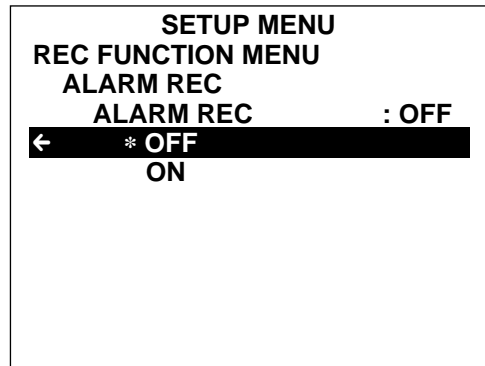

- 2** Highlight ON by pressing the **▼** key.
3 Press the SET key to leave Menu mode.
4 Insert a cassette.
5 Press the REC key.

The ALARM indication of the indication window lights, and alarm recording will be activated.

To activate alarm recording

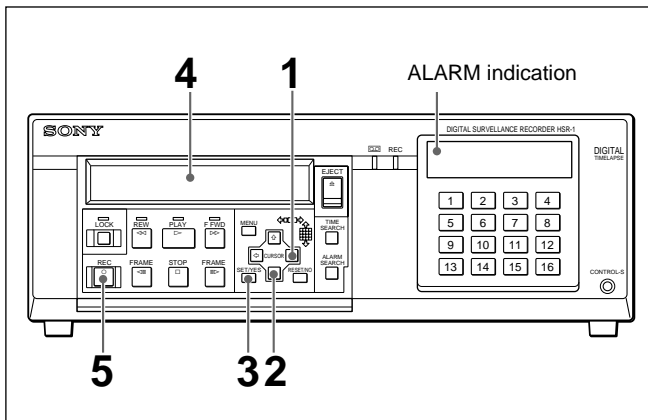

- 1** Highlight ALARM REC on the third line of the display shown in step **3** on the previous page, then press the **▶** key.

The menu shifts to the alarm recording ON/OFF selection.

To cancel alarm recording

To stop recording in progress

Press the STOP key.

To cancel alarm recording

Return the ALARM REC setting to OFF on the display in step **1**.

If there is recording in progress, it will be continued.

Repeat Recording

You can set the recorder to record on a single cassette repeatedly.

When the tape reaches its end during recording, it is automatically rewound to the beginning, and the recorder continues recording.

Pictures are stored on the built-in hard disk while the tape is rewinding so that recording can continue without a break.

To activate repeat recording

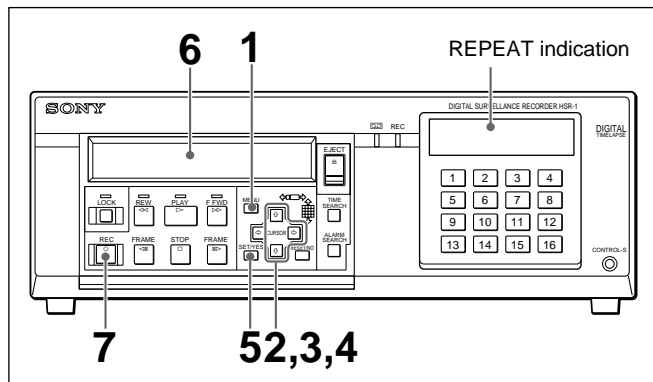

See Chapter 4 “Menu Operations” for additional information.

- 1 Enter Menu mode by pressing the MENU key.
- 2 Highlight REC FUNCTION MENU (or display “RecFuncMenu” on the front panel) of the Top menu (page 4-5) by pressing the \uparrow or \downarrow key, then press the \rightarrow key.

The Recording Function menu is displayed.

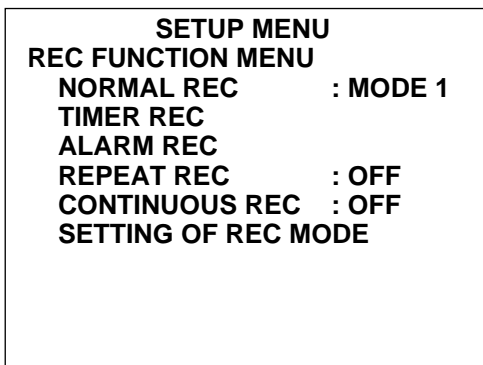

- 3 Highlight REPEAT REC (or display “RepeatRec”) by pressing the \uparrow or \downarrow key, then press the \rightarrow key.

The menu shifts to repeat recording ON/OFF selection.

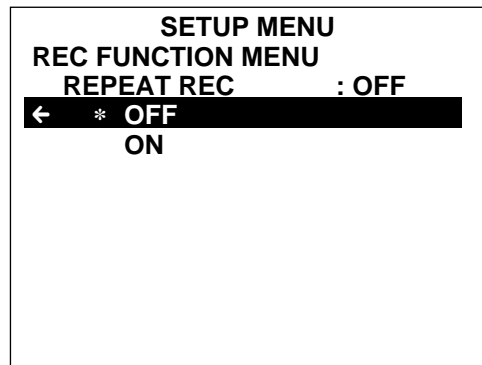

- 4 Highlight (or display) ON by pressing the \downarrow key.
- 5 Press the SET key to leave Menu mode.
- 6 Insert a cassette.
- 7 Press the REC key.

The REC indicator and the REPEAT indication of the indicator block light, and recording begins. Recording is made in Recording mode set in “Normal Recording” (page 2-5).

To cancel repeat recording

To stop recording in progress

Press the STOP key.

To cancel repeat recording

Return the REPEAT REC setting to OFF in step 3. If there is recording in progress, it will be continued.

Continuous Recording

When you activate the continuous recording, pictures are stored on the built-in hard disk so that recording can continue without a break.

While a cassette is being replaced, the valid time of continuous recording (the remaining valid time for storing on the hard disk) is displayed on the monitor screen and the character display, counting the time down.

To activate continuous recording

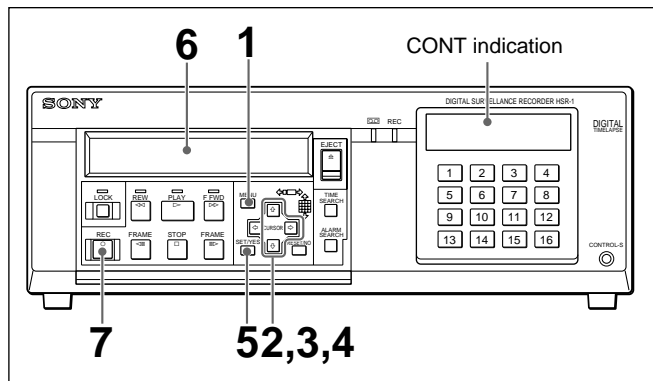

See Chapter 4 “Menu Operations” for additional information.

- 1 Enter Menu mode by pressing the MENU key.
- 2 Highlight REC FUNCTION MENU (or display “RecFuncMenu” on the front panel) of the Top menu (page 4-5) by pressing the \uparrow or \downarrow key, then press the \rightarrow key.

The Recording Function menu is displayed.

```
SETUP MENU
REC FUNCTION MENU
NORMAL REC      : MODE 1
TIMER REC
ALARM REC
REPEAT REC     : OFF
CONTINUOUS REC : OFF
SETTING OF REC MODE
```

- 3 Highlight CONTINUOUS REC (or display “ContRec”) by pressing the \uparrow or \downarrow key, then press the \rightarrow key.

The menu shifts to continuous recording ON/OFF selection.

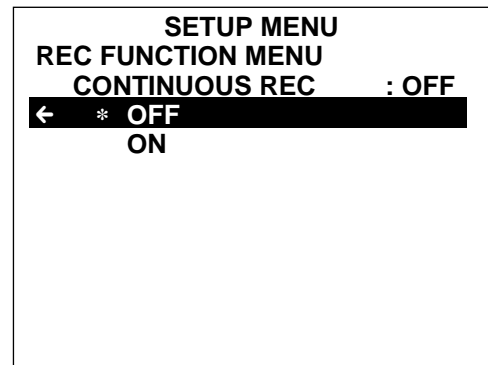

- 4 Highlight (or display) ON by pressing the \downarrow key.
- 5 Press the SET key to leave Menu mode.
- 6 Insert a cassette.
- 7 Press the REC key.

The REC indicator and the CONT indication of the indicator block light, and recording begins.

To change cassettes

- 1 Stop the tape by pressing the STOP key.

When recording reaches the end of the tape, the tape automatically stops and the cassette is ejected (only when Repeat recording is inactive).

The valid time of the continuous recording is displayed on the monitor screen and the character display.

- 2 Press the EJECT key to remove the cassette.
- 3 Insert another cassette.
- 4 Press the REC key.

To cancel continuous recording

To stop recording in progress

Press the STOP key.

To release continuous recording

Return the CONTINUOUS REC setting to OFF in step 3. If there is recording in progress, it will be continued.

Series Recording

Long recording can be performed by switching multiple HSR-1/1P units connected in series.

Requirements for series recording

To activate series recording, it is necessary to connect multiple HSR-1/1P units in series and specify the series recording signal.

For connections, see Chapter 5 “Connections and Preparations.”

Assigning the series recording signal

Assign the series recording signal to either input and output pins of the PARALLEL I/O connector on the rear panel of each HSR-1/1P unit.

By transmitting the series recording signal via the connectors, recording is relayed to the subsequent HSR-1/1P units.

The signal assignment is made from the Remote Control menu.

Once you assign the signal, it is not necessary to set it again unless it needs be changed.

For the Remote Control Menu, see Chapter 4 “Menu Operations.”

To activate series recording

- 1 Turn on the power and insert a cassette in to each HSR-1/1P.
- 2 Press the REC key on the first HSR-1/1P.

Recording starts on the first HSR-1/1P.

When the remaining time of the tape is near 2 minutes, the first HSR-1/1P unit sends a series recording signal to the next HSR-1/1P unit via the PARALLEL I/O connector.

When the next HSR-1/1P unit receives the signal, it starts recording.

To cancel series recording

Press the STOP key on the HSR-1/1P unit on which recording is in progress.

Alarm Search

Alarm recordings are listed in the order of generation, and you can locate the picture at the specified alarm recording.

The tape rewinds or fast-forwards, searching for the tape position of the specified alarm recording. When the specified position is located, the image at that position is reproduced in Still mode.

To execute Alarm search

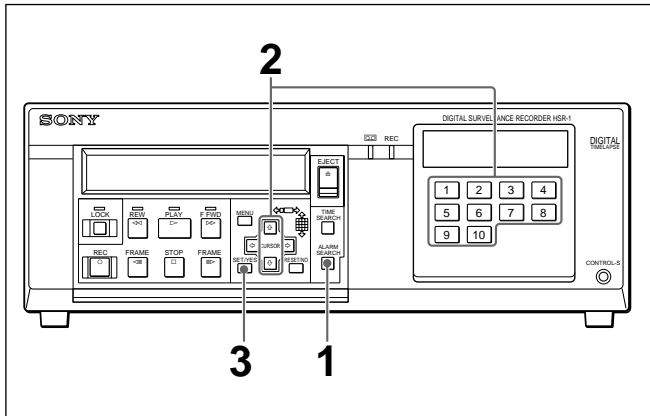

1 Press the ALARM SEARCH key.

The ALARM SEARCH display appears on the monitor screen, listing alarm recordings recorded on the tape, if any.

ALARM SEARCH				
01:98	1 31	2:32: 16	AM	
02:98	1 31	2:32: 16	AM	
03:98	1 31	2:32: 16	AM	
04:98	1 31	2:32: 16	AM	
05:98	7 25	11:59: 41	PM	
06:98	7 25	11:59: 41	PM	
07:98	7 25	11:59: 41	PM	
08:98	7 25	11:59: 41	PM	
μ SEARCH: SET		↑μ : SHIFT		
ABORT: ALARM SEARCH				

The list can show up to eight recordings at a time. If there are 9 alarm recordings or more, an arrow flashes at the bottom of the list.

When you press the \downarrow key with the lowest line of the list highlighted, the list scrolls to show the next line.

2 Highlight the alarm recording to be located by pressing the \uparrow or \downarrow key.

You can also specify it by entering the number using the numeric keys.

3 Press the SET key.

Notes

- Data of up to 99 alarm recordings can be displayed on the alarm list of the recorder. When there are 100 or more alarm recordings, data of the first alarm recording and the latest 98 recordings are listed.
- Alarm recording in FRAME mode cannot be located by an alarm search operation. Any alarm input in FRAME mode is not registered to the alarm list.
- The alarm list is lost when the cassette is unloaded. Alarm search using an alarm list is possible only with a cassette that stays in the unit after being used for recording.

Alarm search without an alarm list

If an alarm list is lost, such as with a previously recorded tape, you can search for an alarm recording relative to the current tape position.

When an alarm list is available, however, alarm search is always made using the alarm list.

1 Insert a recorded cassette.

2 Press the ALARM SEARCH key.

3 Using the \uparrow or \downarrow key, specify the sequential number (in order from the current tape position) of the desired alarm recording.

The + mark specifies that the order is in the forward direction and the – mark in the reverse direction.

The valid range is from +99 to –99.

4 Press the SET key.

The tape runs in rewind or fast-forward mode to locate the tape position specified in step **3**.

When the specified position is located, the image at that position is reproduced in Still mode.

To cancel an alarm search

- If you have not yet pressed the SET key, press the ALARM SEARCH key again.
- If the tape is being searched, press the STOP key.

HDD Recording/Playback

If no cassette is loaded, this unit performs recording/playback using the built-in hard disk (HDD) only.

To execute HDD recording

- 1 Remove the cassette from the unit.
- 2 Press the REC key.

The REC indicator lights, and recording begins in the specified Recording mode.

The indication “NO TAPE” flashes on the upper right corner of the screen.

Notes

- The time available for HDD recording depends on the Recording mode. During recording, the available recording time (in minutes) is displayed on the screen and the front panel. The display on the screen can be erased by pressing any key.
- When the available time elapses, data will be overwritten from the oldest.
- If there are data already recorded on the hard disk, new data will be appended to the end of the previous recording on the hard disk.

To stop HDD recording

- 1 Press the STOP key.

Recording stops, and a message to confirm that data on the hard disk should be erased is displayed. When Continuous recording is active, a message to confirm that recording should be stopped is displayed first. In this case, press the STOP key again.

- 2 Press the NO key.

To execute HDD playback

- 1 Execute HDD recording.
- 2 Stop HDD recording.
- 3 Press the PLAY key.

The data recorded on the hard disk are played from the beginning.

Notes

- High-speed search and variable playback can be performed in the same manner as when using a tape.
- When you try to play before the HDD recording starting or past the ending point, a message “No playback data” is displayed.

To erase data from the hard disk

- 1 Press the STOP or EJECT key.

A message to confirm that data on the hard disk should be erased is displayed.

If there is no HDD recording, no message appears.

- 2 Press the YES key.

To copy the data from the hard disk to a tape

- 1 Execute HDD recording.

- 2 Insert a cassette.

A message “Press the REC key.” is displayed.

- 3 Press the REC key.

The data on the hard disk are recorded on the tape. When you insert a cassette during HDD recording, the HSR-1/IP shifts to normal recording. When a cassette is inserted in a mode other than HDD recording, the HSR-1/IP copies data to the tape and shifts to STOP mode.

Note

You may rewind or fast-forward the tape before pressing the REC key. Note, however, that if you play the tape before pressing the REC key, the data on the hard disk will be lost.

High-Speed Playback

The high-speed playback function permits you to check the data on the tape at a higher speed than with normal high-speed search.¹⁾

Using this function, you can check an entire 270-minute tape in 270 minutes.

To execute high-speed playback

- 1 Insert a recorded cassette.
- 2 Press the PLAY key while holding down the FRAME II▶ key.

To stop high-speed playback

Press the STOP key.

Note

If you switch the operation from high-speed playback to variable-speed playback by pressing either FRAME key, subsequent playback may not be correctly performed. To precisely check the data on the tape, first stop the high-speed playback, then use normal playback mode.

1) Normal high-speed search means the high-speed search executed by pressing the F FWD key in normal playback mode or executed using the SHUTTLE dial of the SVRM-100A.

Menu Operations

Menu Operations

Menu mode enables you to make various settings. The menus are displayed on the monitor connected via the VIDEO IN A connector or S-VIDEO connector on the rear panel. The menu items are also displayed on

the character display on the front panel of this recorder one by one.

Layered Structure of the Menu Items

The menu items are layered and menu operations are achieved while shifting between these layers. Use the CURSOR \uparrow or \downarrow key to move within the same layer. Use the CURSOR \rightarrow or \leftarrow key to move from one layer to another. Some items incorporate special setting displays.

Grade of items

The menu items are classified into the following two grades:

- **BASIC items:** Items to be relatively often changed in accordance with circumstances
- **ENHANCED items:** Items which will rarely be changed once set.

First Layer	Second Layer	Third Layer	Fourth Layer
IMAGE CONTROL MENU	A IMAGE	MONITOR	MANUAL
INDICATION CONTROL MENU	B IMAGE	ALARM CHANGE	AUTO
REC FUNCTION MENU	CAMERA CONNECTION	AUTO CYCLE	
FUNCTION CONTROL MENU	MONI DISP STRUCTURE		
REMOTE CONTROL MENU	PLAY DISP STRUCTURE		
MAINTENANCE MENU			
TIME ADJUST	TIME ADJUST display		
MENU INITIALIZE	MENU INITIALIZE display		
MENU GRADE	BASIC		
	ENHANCED		
LANGUAGE	JAPANESE		
	ENGLISH		

..... There is a subsequent layer.

Enhanced items: Displayed when MENU GRADE is set to ENHANCED (Factory-setting). You can display only the basic items other than enhanced items.

See "To display the basic items only" on page 4-4.

Menu Operations

Basic Display Layout

Monitor screen

The item currently selected is highlighted.
A flashing arrow at the far right means that the item has a subsequent layer.
A flashing arrow at the far left means that the item comes after the preceding layer.
The items of the lower layer are accordingly indented in relation to those of the upper layer.

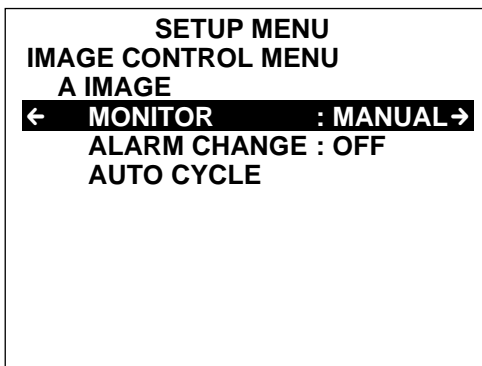

The current setting, if any, of the item is displayed on the same line on the display.

Language selection

The language (English/Japanese) for menu display can be changed by LANGUAGE of the Top menu.

Character display

Each time an arrow key is pressed, the character display on the front panel of the HSR-1/IP shows the next item in the direction of the arrow. The layer level is indicated by > marks. The number of > marks indicates which layer you are at.

Example:

First layer	Image Menu	(no > mark)
Second layer	>A Image	
Third layer	>>Monitor	
Fourth layer	>>>Manual	

The items are displayed in English on the character display.

Keys Used for Menu Operations

For menu operations, use the keys of the Menu operation block and the numeric keys.

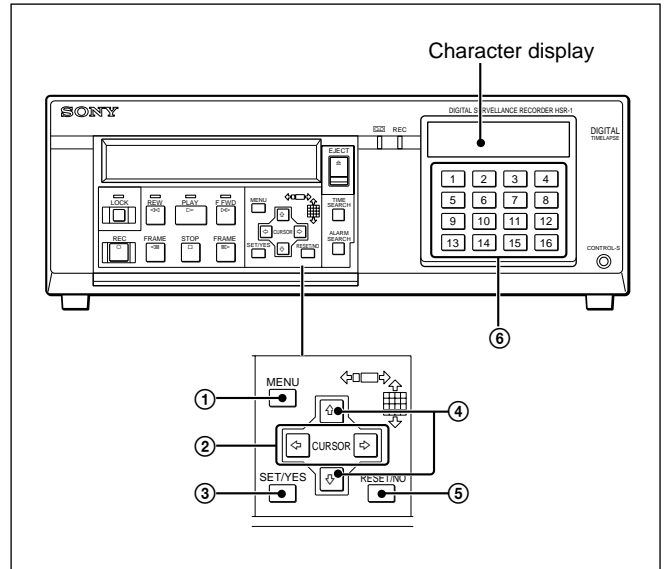

① MENU key

Press to enter Menu mode. Press it again to leave Menu mode.

If you press this key before registering a setting on the menu by pressing the SET key, the setting is canceled.

② CURSOR ←/→ keys

Press to move from a layer to another.

③ SET/YES key

Press to register a new or updated setting. Use this key to answer YES to a confirmation message.

④ CURSOR ↑/↓ keys

Press to select the items or setting on the same layer.

⑤ RESET/NO key

Use this key to answer NO to a confirmation message.

⑥ Numeric keys

Press to directly enter a numeric value.

Setting the Menu Items

- 1 Press the MENU key.
The recorder enters Menu mode.

Monitor screen

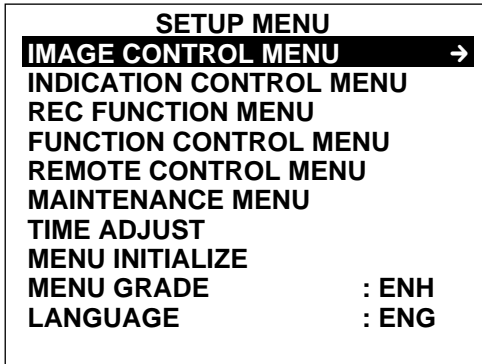

Character display

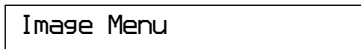

The item selected when you left the menu the last time is highlighted on the monitor and displayed on the character display on the front panel.

- 2 Highlight (or display) the item to be set by pressing the \uparrow or \downarrow key.
Pressing the \downarrow key selects the item on the next line and pressing the \uparrow key selects the previous line of the same layer.

- 3 Press the \rightarrow key.
The recorder enters the next layer of the selected item.

Monitor screen

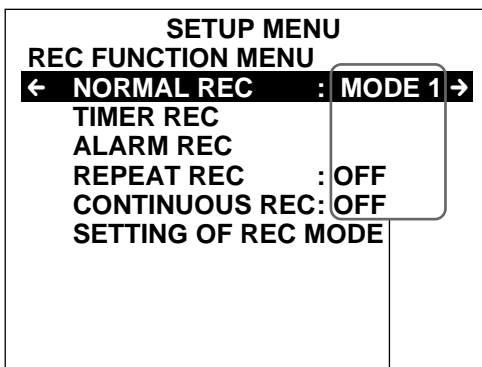

Current settings

Character display

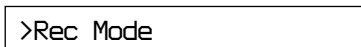

- 4 Highlight (or display) the item to be set by pressing the \uparrow or \downarrow key, then press the \rightarrow key to move to the next layer.

For the item for which the current setting is displayed on the layer in step 3, the setting parameters are now displayed.

Monitor screen

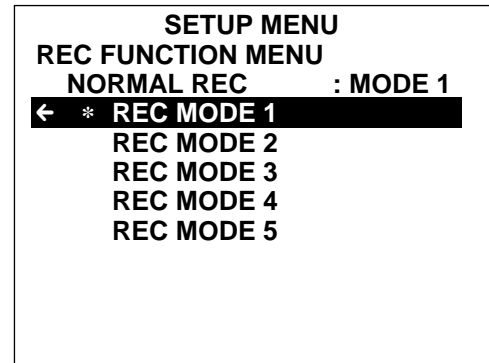

An asterisk (*) indicates the value is the default setting.

Character display



The other items have the subsequent layers. Highlight (or display) the item to be set by pressing the \uparrow or \downarrow key, then press the \rightarrow key to move to the next layer. Pressing the \rightarrow key with an item that has no subsequent layer is ignored.

- 5 Press the \uparrow or \downarrow key to select the setting.
- 6 Press the SET key.
The message “NOW SAVING” is displayed, and the setting is registered in nonvolatile memory.

The setting procedure may differ with the items incorporated in special setting displays. See the corresponding paragraph for the setting procedures.

To restore to the previous setting

Before pressing the SET key, press the MENU key. The message “ABORT !” is displayed, and the previous setting is restored.

Note

If power is cut off while data are being written into nonvolatile memory, the setting data may be lost. Do not turn off the power to the recorder while the message “NOW SAVING” is being displayed.

Menu Operations

To display the basic items only

The menu is set to Enhanced grade at the factory to display both the basic and enhanced items. To display the basic items only, proceed as follows:

- 1 Highlight MENU GRADE (or display “Menu grade”) on the Top menu by pressing the \uparrow or \downarrow key.

Monitor display

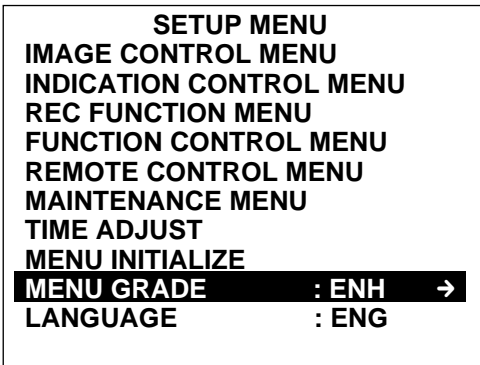

Character display

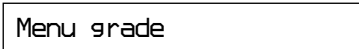

- 2 Proceed to the next layer by pressing the \rightarrow key.
- 3 Select BASIC (or display “Basic”) by pressing the \uparrow key.

Monitor display

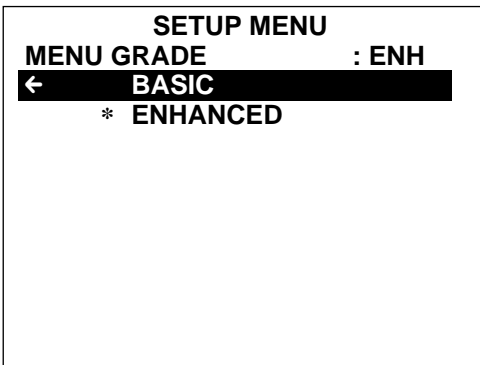

Character display



- 4 Press the SET key. The message “NOW SAVING” is displayed, and the enhanced items will not be displayed when you activate Menu mode the next time.

Returning to the Default Settings – Initializing

To restore the factory (default) settings for the menu items (initialize the items) after having changed them, proceed as follows.

- 1 Highlight MENU INITIALIZE (or display “Menu Init”) on the Top menu by pressing the \uparrow or \downarrow key.

The MENU INITIALIZE display appears.

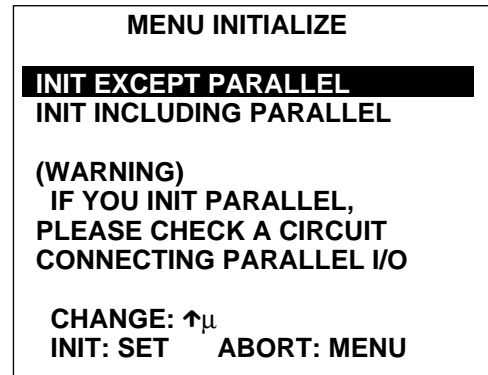

- 2 Specify whether to initialize the menu except the parallel input/output settings or to initialize the menu including the parallel input/output settings.

Note that the parallel input/output settings include those to specify the output signal voltages. Connected external circuits can be damaged if these settings are improperly changed.

- 3 Press the SET/YES key.

The specified item is returned to the default setting.

Menu Items

Top Menu (First Layer)

Monitor display

SETUP MENU
IMAGE CONTROL MENU
INDICATION CONTROL MENU
REC FUNCTION MENU
FUNCTION CONTROL MENU
REMOTE CONTROL MENU
MAINTENANCE MENU
TIME ADJUST
MENU INITIALIZE
MENU GRADE : ENH
LANGUAGE : ENG

The menus marked with are enhanced menus, which are displayed only when MENU GRADE is set to ENH.

Character display

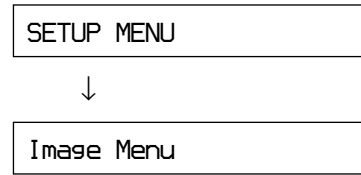

The top menu item selected when you left the menu the last time is displayed.

The setting shown in **bold characters** in the Layer 2 column of the table is the standard setting and is displayed with an asterisk on the monitor screen.

Display Layer 1	Layer 2	Char. display	Contents
IMAGE CONTROL MENU	Image Menu	Image Menu	Menu to set the items regarding monitoring and playback. <i>See "Image Control Menu" on page 4-6.</i>
INDICATION CONTROL MENU	Indct Menu	Indct Menu	Menu to set the items regarding character data to be indicated on the screen. <i>See "Indication Control Menu" on page 4-8.</i>
REC FUNCTION MENU	RecFuncMenu	RecFuncMenu	Menu to set the items regarding recording functions. <i>See "Recording Function Menu" on page 4-10.</i>
FUNCTION CONTROL MENU	FuncMenu	FuncMenu	Menu to set the items regarding special functions, such as auto rewind and beep sound. <i>See "Function Control Menu" on page 4-11.</i>
REMOTE CONTROL MENU	Remote Menu	Remote Menu	Menu to set the items regarding external controls via RS-232C and PARALLEL I/O. <i>See "Remote Control Menu" on page 4-13.</i>
MAINTENANCE MENU	Mainte Menu	Mainte Menu	Menu for maintenance, such as the hours meter and self-diagnosis. <i>See "Maintenance Menu" on page 4-15.</i>
TIME ADJUST	Time Adjust	Time Adjust	Enters the mode to set the built-in clock. <i>For details, see "Setting the Clock" on page 5-5.</i>
MENU INITIALIZE	Menu Init	Menu Init	Initializes the menu settings.
MENU GRADE		Menu grade	Selects the items to be displayed.
	BASIC	>Basic	Displays only the basic items.
	ENHANCED	>Enhanced	Displays both the basic and enhanced items.
LANGUAGE		Language	Selects the language for superimposing.
	ENGLISH	>English	
	JAPANESE	>Japanese	

Menu Items

Image Control Menu

Monitor screen

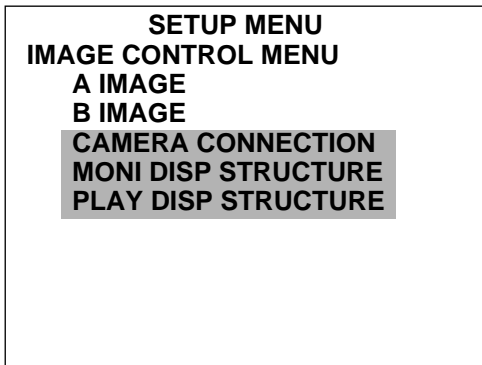

Character display

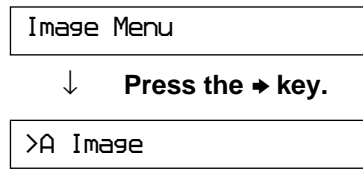

The Image Control menu item selected when you left the menu the last time is displayed.

The items marked with are enhanced items, which are displayed only when MENU GRADE is set to ENH on the top menu.

The setting shown in **bold characters** in the Layer 3 or Layer 4 column of the table is the standard setting and is displayed with an asterisk on the monitor screen.

Display Layer 2	Layer 3		Char. display	Contents
	Layer 3	Layer 4		
A IMAGE			>A Image	Selects the items regarding the video output from the VIDEO OUT A connector.
	MONITOR		>>Monitor	Selects the output method in monitoring.
		MANUAL	>>>Manual	Selects the camera input to be monitored with the camera number key.
		AUTO	>>>Auto	Cyclically switches the camera input to be monitored.
	ALARM CHANGE		>>Alm Chang	Determines whether the picture for monitoring to be switched upon an alarm input.
		OFF	>>>OFF	Does not switch the picture upon alarm input.
		ON	>>>ON	Switches the picture to that from the camera for which an alarm is input.
AUTO CYCLE		>>AutoCycle	Enters the setting mode for the cycle of automatic monitor switching. n = 1 to 60	
	n SEC (5)	n sec	<i>For the setting procedure, see "Setting the Automatic Change Cycle" on page 5-10.</i>	
B IMAGE			>B Image	Selects the items regarding the video output from the VIDEO OUT B connector.
	IMAGE		>>Image	Selects the picture to be output.
		A IMAGE	>>>A Image	Outputs the same video signal as that from the VIDEO A connector.
		AUTO	>>>Auto	Outputs pictures from cameras by cyclically switching the cameras.
		Camera n	>>>Camera n	Steadily outputs the picture from the specific camera. n = camera number 1 to 16
	ALARM CHANGE		>>Alm Chang	Determines whether the picture for monitoring to be switched upon an alarm input.
		OFF	>>>OFF	Does not switch the picture upon an alarm input.
		ON	>>>ON	Switches to the picture from the camera for which an alarm is input.
	AUTO CYCLE		>>AutoCycle	Enters the setting mode for the cycle of automatic monitor switching. n = 1 to 60
		n SEC (5)	n sec	<i>For the setting procedure, see "Setting the Automatic Change Cycle" on page 5-10.</i>

Display Layer 2			Char. display	Contents
	Layer 3	Layer 4		
CAMERA CONNECTION			>CamConnect	Enters the mode to set the connection statuses of cameras. <i>For the setting procedure, see "Setting the Camera to Use" on page 5-6.</i>
	NO/CONNECT		–	
MONI DISP STRUCTURE			>Moni Disp	For setting the screen structure for monitoring.
	n DIVISION		>>n Div	Enters the setting mode to assign cameras to the divisions of the screen in each dividing mode for monitoring. n = the number of divisions: 4, 6, 7, 8, 9, 10, 13, 16 <i>For the setting procedure, see "Setting the Display Structures" on page 5-8.</i>
PLAY DISP STRUCTURE			>Play Disp	For setting the screen structure for playback.
	n DIVISION		>>n Div	Enters the setting mode to assign cameras to the divisions of the screen in each dividing mode for playback/monitoring. n = the number of divisions: 4, 6, 7, 8, 9, 10, 13, 16 <i>For the setting procedure, see "Setting the Display Structures" on page 5-8.</i>

Menu Items

Indication Control Menu

Monitor screen

SETUP MENU	
INDICATION CONTROL MENU	
BORDER LINE	: BLACK
DATE FORMAT	: M D Y
MONTH FORMAT	: NUMBER
TIME FORMAT	: 12H
FRNT TIME DISP	: TM MD
MONI CHAR TYPE	: WHITE
MONI CHAR POS	: UP
MONI CHAR INFO	
REC CHAR POSI	: UPLEFT
REC CHAR INFO	
CAMERA NAME	

The items marked with are enhanced items, which are displayed only when MENU GRADE is set to ENH on the Top menu.

Character display

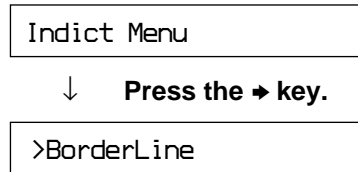

The Indication Control menu item selected when you left the menu the last time is displayed.

The setting shown in **bold characters** in the Layer 3 or 4 column of the table is the standard setting and is displayed with an asterisk on the monitor screen.

Display Layer 2	Layer 3	Char. display	Contents
BORDER LINE		>BorderLine	Determines the lines separating the divisions in screen dividing mode.
	BLACK	>>Black	Separates the divisions with black lines.
	WHITE	>>White	Separates the divisions with white lines.
	NO	>>NO	Displays no lines.
DATE FORMAT		>DateFormat	Determines the format of date indication.
	YEAR MONTH DAY	>>Y M D	Displays in the order of year/month/day.
	MONTH DAY YEAR ¹⁾	>>M D Y	Displays in the order of month/day/year.
	DAY MONTH YEAR	>>D M Y	Displays in the order of day/month/year.
MONTH FORMAT		>Month Form	Determines the format of month indication.
	NUMBER	>>Number	
	ALPHABET	>>Alphabet	
TIME FORMAT		>Time Format	Determines the format of time indication.
	12H	>>12H	
	24H	>>24H	
FRNT TIME DISP		>Front Time	Selects the time data to be displayed in the time data display on the front panel.
	TIME MODE	>>Time Mode	Displays the selected time mode.
	REC TIME	>>Rec Time	Displays the available time for recording in recording mode and the selected time mode in other modes.
	TIME	>>Time	Displays the current clock time.
MONI CHAR TYPE		>MonChrType	Selects the type of characters to be superimposed in monitoring.
	WHITE	>>White	Superimposes white characters on black background.
	BLACK	>>Black	Superimposes black characters on white background.
MONI CHAR POS		>MonChrPos	Selects the position of character display on the screen.
	UP	>>UP	Displays information, such as date/time and operating status of the recorder, on the upper of the screen.
	DOWN	>>Down	To be selected if the upper display area is lost owing to the monitor's characteristics.

1) The standard setting for the HSR-1P is DAY MONTH YEAR while that for the HSR-1 is MONTH DAY YEAR.

Display Layer 2	Layer 3	Layer 4	Char. display	Contents
MONI CHAR INFO			>MonChrInfo	Selects the character data to be displayed on the screen.
	CAMERA NAMES		>>Cam Name	Determines whether to display the camera names.
		DISPLAY	>>>Display	
		NO	>>>No Disp	
	DATE		>>Date Info	Determines whether to display the date.
		DISPLAY	>>>Display	
		NO	>>>No Disp	
	TIME		>>Time Info	Determines whether to display the time.
		DISPLAY	>>>Display	
		NO	>>>No Disp	
	REC MODE		>>Rec Mode	Determines whether to display the recording mode.
		DISPLAY	>>>Display	
		NO	>>>No Disp	
	TIME MODE		>>Time Mode	Determines whether to display the time mode.
		DISPLAY	>>>Display	
		NO	>>>No Disp	
	QUALITY MODE		>>Quality	Determines whether to display the quality mode.
		DISPLAY	>>>Display	
		NO	>>>No Disp	
	REC CYCLE		>>RecCycle	Determines whether to display the recording cycle.
		DISPLAY	>>>Display	
		NO	>>>No Disp	
REC CHAR POSI			>RecChrPos	Determines the position to superimpose the recorded characters.
	UP LEFT		>>Up Left	
	UP RIGHT		>>Up Right	
	LOW LEFT		>>Low Left	
	LOW RIGHT		>>Low Right	
REC CHAR INFO			>RecChrInfo	Selects the character data to be recorded.
	CAMERA NO.		>>Camera No.	Determines whether to record the camera number to be superomposed at the lower right.
		DISPLAY	>>>Display	
		NO	>>>No Disp	
	DATE		>>Date Info	Determines whether to record the date.
		DISPLAY	>>>Display	
		NO	>>>No Disp	
	TIME		>>Time Info	Determines whether to record the time.
		DISPLAY	>>>Display	
		NO	>>>No Disp	
CAMERA NAME			>CameraName	Enters the mode to set the camera names. <i>For the setting procedure, see "Setting Camera Names" on page 5-7.</i>

Recording Function Menu (Enhanced Menu)

Monitor screen

SETUP MENU	
REC FUNCTION MENU	
NORMAL REC	: MODE 1
TIMER REC	
ALARM REC	
REPEAT REC	: OFF
CONTINUOUS REC	: OFF
SETTING OF REC MODE	

Character display

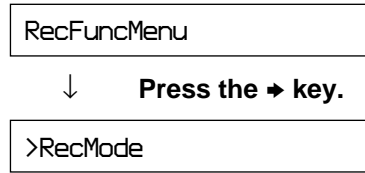

The Recording Function menu item selected when you left the menu the last time is displayed.

The setting shown in **bold characters** in the Layer 3 or 4 column of the table is the standard setting and is displayed with an asterisk on the monitor screen.

Display Layer 2	Layer		Char. display	Contents
	Layer 3	Layer 4		
NORMAL REC			>Rec Mode	Selects Recording mode for normal recording.
		REC MODE 1	>>Mode 1	
		REC MODE 2	>>Mode 2	
		REC MODE 3	>>Mode 3	
		REC MODE 4	>>Mode 4	
		REC MODE 5	>>Mode 5	
TIMER REC			>Timer Rec	Selects the items to be set for Timer recording.
	TIMER REC		>>Timer Rec	Determines whether to activate Timer recording.
		OFF	>>>OFF	Does not activate Timer recording.
		ON	>>>ON	Activates Timer recording in accordance with the Timer setting.
		TIMER	>>Timer	Enters the timer setting mode. <i>For the setting procedure, see "Timer Recording" on page 3-1.</i>
ALARM REC			>Alarm Rec	Selects the items to be set for Alarm recording.
	ALARM REC		>>Alarm Rec	Determines whether to activate Alarm recording.
		OFF	>>>OFF	
		ON	>>>ON	
		ALARM SET	>>Alarm Set	Enters the setting mode for Alarm recording. <i>For the setting procedure, see "Alarm Recording" on page 3-4.</i>
REPEAT REC			>Repeat Rec	Determines whether to activate Repeat recording.
		OFF	>>OFF	
		ON	>>ON	
CONTINUOUS REC			>Contin Rec	Determines whether to activate Continuous recording.
		OFF	>>OFF	
		ON	>>ON	
SETTING OF REC MODE			>RecModeSet	Enters the setting mode for each Recording mode.
		RECORDING MODE n	>>Mode n	n = Recording mode number 1 to 5 <i>For the setting procedure, see "Setting the Recording Modes" on page 5-11.</i>

Function Control Menu

Monitor display

SETUP MENU	
FUNCTION CONTROL MENU	
AUTO REW	: ON (PB)
POWER ON REC	: OFF
BEEP	: ON
STILL	: FRAME
FUNCTION LEVEL SET	
PASSWORD SET	

The item marked with is an enhanced item, which is displayed only when MENU GRADE is set to ENH on the Top menu.

Character display

Func Menu
↓ Press the → key.
>AutoREW

The setting shown in **bold characters** in the Layer 3 column of the table is the standard setting and displayed with an asterisk on the monitor screen.

Display Layer 2	Layer 3	Char. display	Contents
AUTO REW ¹⁾		>AutoREW	Specifies the operation at tape end.
	ON	>>ON	Automatically starts rewinding at tape end.
	ON(PB)	>>ON(PB)	Automatically starts rewinding at tape end in modes other than recording. In recording mode, the tape stops at tape end.
	OFF	>>OFF	Stops the tape at the tape end.
POWER ON REC		>PowerOnREC	Determines whether to start recording when power is turned on.
	OFF	>>OFF	
	ON	>>ON	
BEEP		>Beep	Determines whether to sound the beep at key input, at tape end in recording, or when an error occurs.
	ON	>>ON	
	OFF	>>OFF	
STILL		>Still	Selects still mode.
	FRAME	>>Frame	Frame still
	FIELD	>>Field	Field still. Select to eliminate blurring of images in a fast-moving picture. The vertical resolution is reduced to half.
FUNCTION LEVEL SET		>FuncLevel	Determines the levels to control the recorder's functions using passwords of three levels.
	PLAY	>>PLAY	Sets the level for functions for playback, such as PLAY and SEARCH.
	REC	>>REC	Sets the level for the REC function.
	F.FWD/REW	>>F.FWD/REW	Sets the level for the F.FWD/REW functions.
	EJECT	>>EJECT	Sets the level for the EJECT function.
	MONI CHANGE	>>MoniChng	Sets the level for the functions for monitor change control.
	BASIC MENU	>>Bsc Menu	Sets the level for changing the basic menu settings.
	ENHANCE MENU	>>Enh Menu	Sets the level for changing the enhanced menu settings. Note: If a level lower than that for the basic menu is specified, the level for the basic menu is applied.

1) In Repeat recording, recording is continuously performed regardless of the AUTO REW setting on this menu.

(Continued)

Menu Items

Display Layer 2	Layer 3	Layer 4	Char. display	Contents
Common to all FUNCTION LEVEL SET Layer 3 items		NON	>>>NON	Applies no password restriction. Operable even in LOCK mode.
		LEVEL1	>>>Leve11	Enables the function(s) in LOCK mode with any of the passwords of level 1, 2, and 3. ¹⁾
		LEVEL2	>>>Leve12	Enables the function(s) in LOCK mode with either of the passwords of level 1 and 2. ¹⁾
		LEVEL3	>>>Leve13	Enables the function(s) in LOCK mode only with the password of level 3. ¹⁾
PASSWORD SET			>Password	For entering passwords to release the locks of three levels.
		LEVEL1	>>Leve11	<i>For the setting procedure, see "Setting Passwords" on page 5-14.</i>
		LEVEL2	>>Leve12	
		LEVEL3	>>Leve13	

1) If no password has been specified at the respective levels, the function(s) is(are) valid even in LOCK mode.

Remote Control Menu (Enhanced Menu)

The Remote Control Menu is an enhanced menu and is displayed only when MENU GRADE is set to ENH on the top menu.

Monitor Display

<p style="text-align: center;"> SETUP MENU REMOTE CONTROL MENU RS232C : 9600 PARALLEL INPUT PARALLEL OUTPUT PARALLEL OUT VOLTAGE </p>
--

Character display

Remote Menu
↓ Press the → key.
>RS232C

The Remote Control menu item selected when you left the menu the last time is displayed.

The setting shown in **bold characters** in the Layer 3 or 4 column of the table is the standard setting and is displayed with an asterisk on the monitor screen.

Display Layer 2	Char. display		Contents	
	Layer 3	Layer 4		
RS232C		>RS232C	For setting the baud rate for the RS-232C interface.	
	n BPS (9600)	>>n bps	n = 1200/2400/4800/9600/19200/38400	
PARALLEL INPUT		>Para Input	For assigning a function to each input pin (24 inputs) of the PARALLEL I/O connector on the rear panel.	
	INm (n PIN)		>>n PIN	m = 1 to 24, n = pin number 2 to 13, 21 to 32
		NO USE	>>>No use	Ignores the input signal.
		STOP	>>>STOP	Command inputs corresponding to the tape transport control keys on the front panel (Active L)
		REC	>>>REC	
		PLAY	>>>PLAY	
		F.FWD	>>>F.FWD	
		REW	>>>REW	
		F.FRAME	>>>F.FRAME	
		R.FRAME	>>>R.FRAME	
		SERIES REC	>>>SerRec	Series-recording signal input (Active L)
		TIME ADJUST	>>>Time Set	Clock set signal input (Active L). The internal clock will be set to 00 minute 00 second within ±15 minutes when the signal is input.
		ALARM RETURN	>>>AlmRtn	Alarm return input (Active L)
		ALARM (L)	>>>Alarm L	Alarm input common to all cameras (Active L)
ALARM n (L)	>>>Alm n L	Independent alarm input to camera n (Active L) n = Camera No. 1 to 16		
ALARM (H)	>>>Alarm H	Alarm input common to all cameras (Active H)		
ALARM n (H)	>>>Alm n H	Independent alarm input to camera n (Active H) n = Camera No. 1 to 16		

(Continued)

Menu Items

Display Layer 2			Char. display	Contents
	Layer 3	Layer 4		
PARALLEL OUTPUT			>ParaOutput	For assigning a function to each output pin (8 outputs) of the PARALLEL I/O connector on the rear panel.
	OUTm (n PIN)		>>n PIN	m = 1 to 8, n = pin number 15 to 18, 33 to 36
		NO USE	>>>No use	Outputs no signal.
		STOP	>>>Stop St	Outputs status signals to indicate the operating statuses of the recorder.
		REC	>>>Rec St	
		PLAY	>>>Play St	
		F.FWD	>>>FFWD St	
		REW	>>>REW St	
		SERIES REC	>>>SeriesRec	
		TIME ADJUSTMENT	>>>Time Set	Outputs the clock set signal when the internal clock counts 00 minute 00 second.
		ALARM RETURN	>>>AlmRetrn	Outputs a signal upon return from alarm recording
		ALARM	>>>Alarm	Outputs a status signal to indicate that alarm recording is in progress.
		TAPE END	>>>Tape End	Outputs a signal when tape end is reached during recording.
		TAPE EXIST	>>>TapeExst	Outputs a signal when a cassette is in the recorder.
		ERROR	>>>Error	Outputs a signal when an error occurs in the recorder.
		VIDEO LOSS	>>>Videolos	Outputs a signal when the video input from a camera set to "CONNECT" is lost.
PARALLEL OUT VOLTAGE			>POutVolt	For setting the output voltage from each output pin (8 outputs) of the PARALLEL I/O connector on the rear panel.
	OUTm (n PIN)		>>n PIN	m = 1 to 8, n = pin number 15 to 18, 33 to 36
		OPEN	>>>Open	Outputs with OPEN/0 V.
		5V	>>>5V	Outputs with 5 V.
		12V	>>>12V	Outputs with 12 V.

Maintenance Menu (Enhanced Menu)

The Maintenance Menu is an enhanced menu and is displayed only when MENU GRADE is set to ENH on the top menu.

Monitor Display

```

      SETUP MENU
    MAINTENANCE MENU
      HOURS METER
    VERSION DISPLAY
  
```

Character display

```

  Mainte Menu
  ↓
  Press the → key.
  >HoursMeter
  
```

The Maintenance menu item selected when you left the menu the last time is displayed.

Display Layer 2	Char. display	Contents
HOURS METER	>HoursMeter	Enters the mode to check the hours meter. <i>For the checking procedure, see "Regular Checks" on page 6-2.</i>
VERSION DISPLAY	>Ver Disp	Shows the software version.

Connections and Preparations

Connections

Video Cameras

Number of cameras

In the standard HSR-1/1P configuration, up to 4 camera can be connected.

By mounting the optional HSRA-11 input boards (max. 3 boards), 4 inputs per board can be added; thus, a maximum of 16 cameras can be connected to the recorder.

For mounting the HSRA-11, refer to the instruction manual for the HSRA-11.

Input signals and level from cameras

VBS or VS signal: 1.0 V_{p-p} ±0.2 V, 75 ohms, unbalanced

Video Monitors

The number of monitors

Monitors can be connected to two BNC-type connectors and one S connectors.

The monitors connected to the BNC connectors can display different pictures.

Output signals and level to monitors

VBS signal: 1.0 V_{p-p} ±0.2 V, 75 ohms, unbalanced (VIDEO OUT)

Y signal: 1.0 V_{p-p} ±0.2 V, 75 ohms, unbalanced (S-VIDEO)

C signal: 0.28 V_{p-p} ±0.06 V (HSR-1) or 0.30 V_{p-p} ±0.06 V (HSR-1P), 75 ohms, unbalanced (S-VIDEO)

Remote Controls

The recorder has a PARALLEL I/O and an RS-232C connector on the rear and a CONTROL-S connector on the front for control from external devices.

PARALLEL I/O connector

For 24 input pins and 8 output pins of this 37-pin D-sub connector, you can assign various functions as required, such as input/output for alarm recording and command inputs for tape transport control.

The assignment is made using the Remote Control menu.

For the functions that can be assigned, see “Remote Control Menu” on page 4-13.

Use the supplied multi connector for connection.

RS-232C connector

Using this 9-pin D-sub connector, you can control the recorder from a computer via an RS-232C interface.

CONTROL-S connector

To this stereo mini jack, you can connect the SVRM-100A remote control unit.

Connections

Connection Examples

Basic system connection

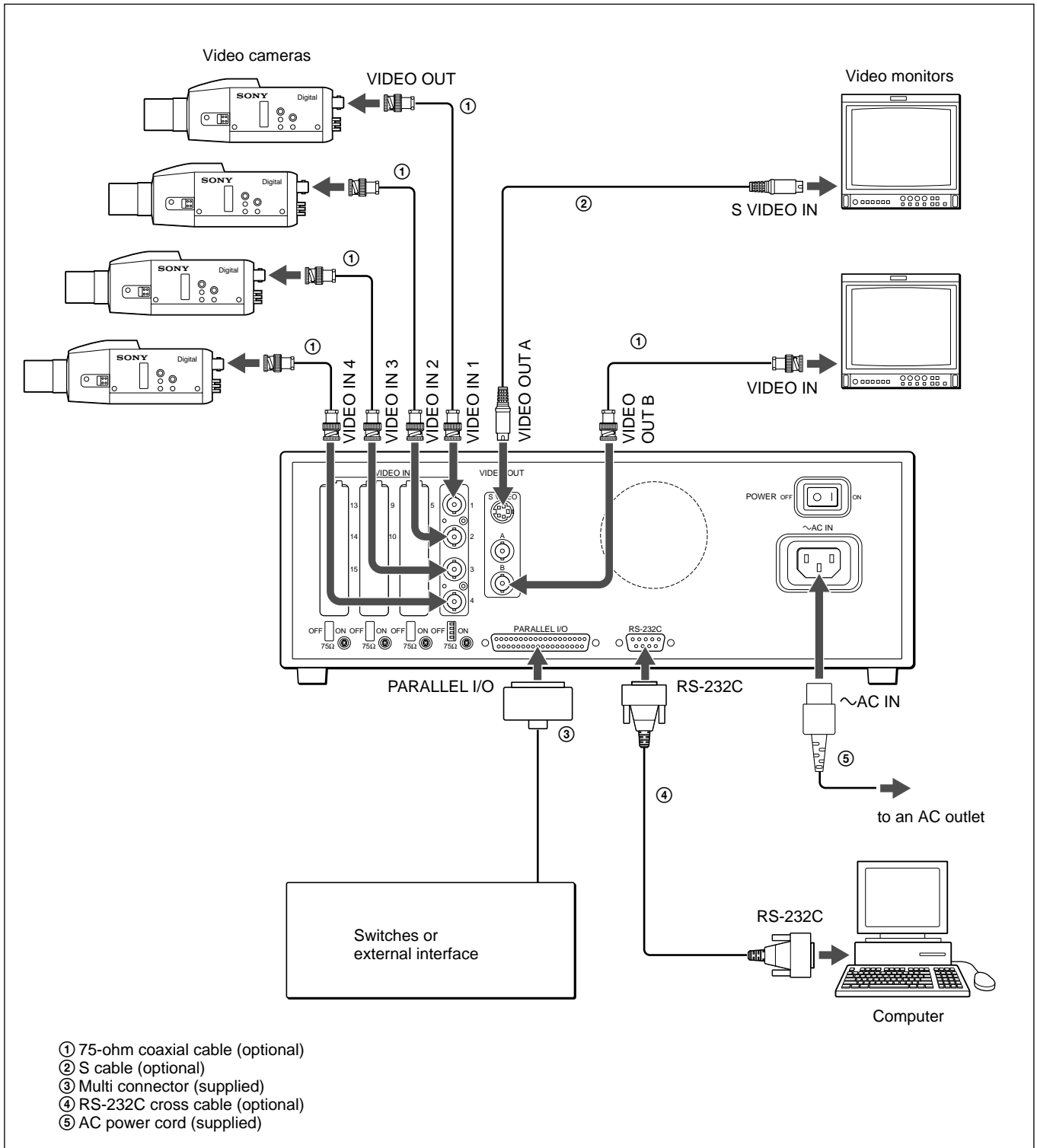

Parallel I/O connection examples

Connection to the PARALLEL I/O connector (D-sub 37-pin) must be achieved with the following specifications by using the supplied multi connector. The functions of the pins can be assigned from the Remote Control menu (page 4-13).

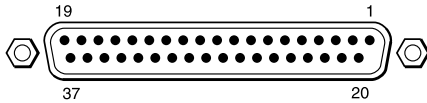

Function	Pin No.	Level	
Power (CN111)	14	12 V	
GND	1, 19, 20, 37		
Input	1-12	2-13	V _H : 4 to 5 V V _L : 0 to 0.6 V Active time: 100 ms or more
	13-24	21-32	
Output	1-4	15-18	V _H 12 V: 11 to 12.3 V (5700 ohms, 2 mA max.) V _H 5 V: 4 to 5.5 V (5700 ohms, 0.8 mA max.) V _L : 0 to 0.6 V (1000 ohms, 12 mA max.) Active time: approx. 1 sec. ^{a)}
	5-8	33-36	

a) In case of an output which shows a status, such as REC, it stays active until the status changes.

Input examples: switches

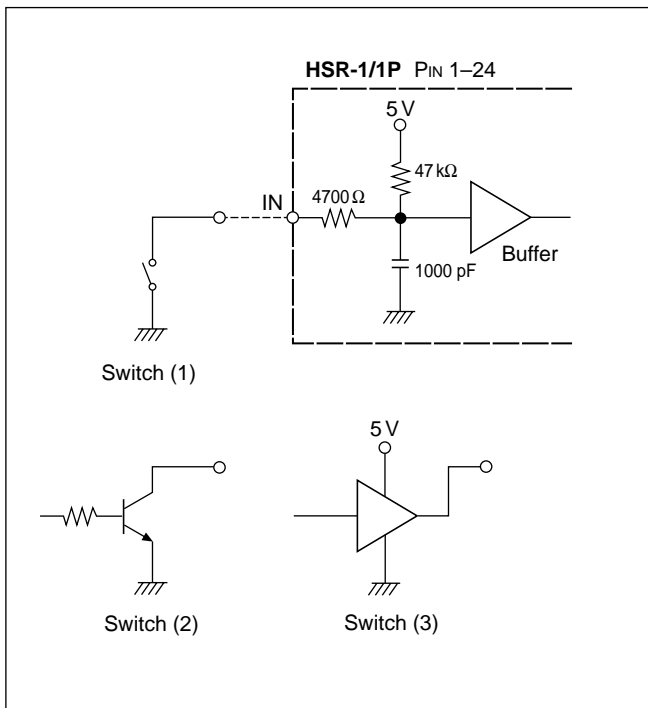

Output examples 1

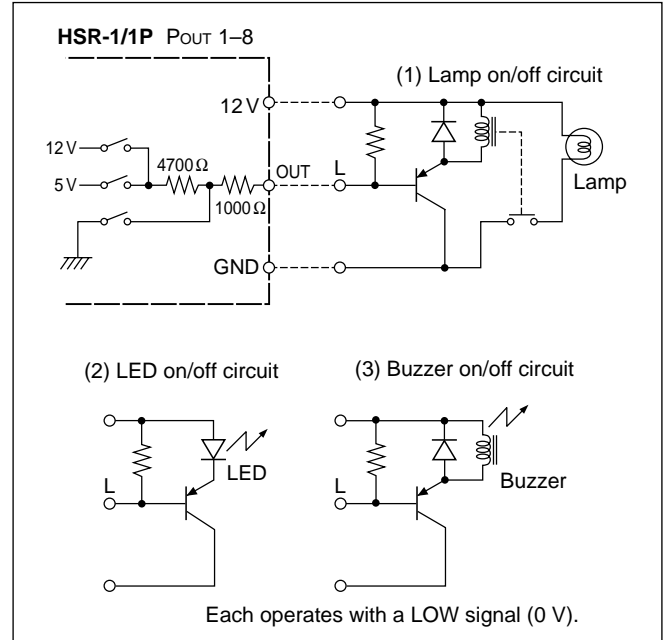

Output examples 2: Direct connections to digital equipment

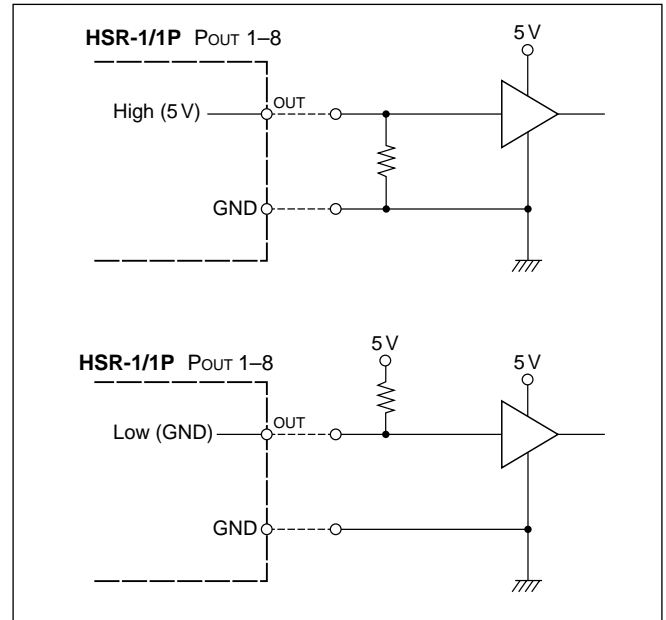

Output example 3: Application of the LOW (GND) output

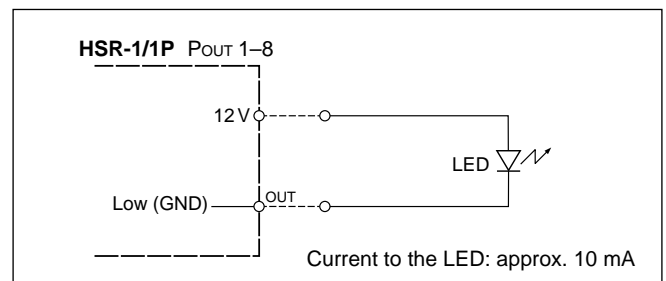

Connections

Connection for series recording

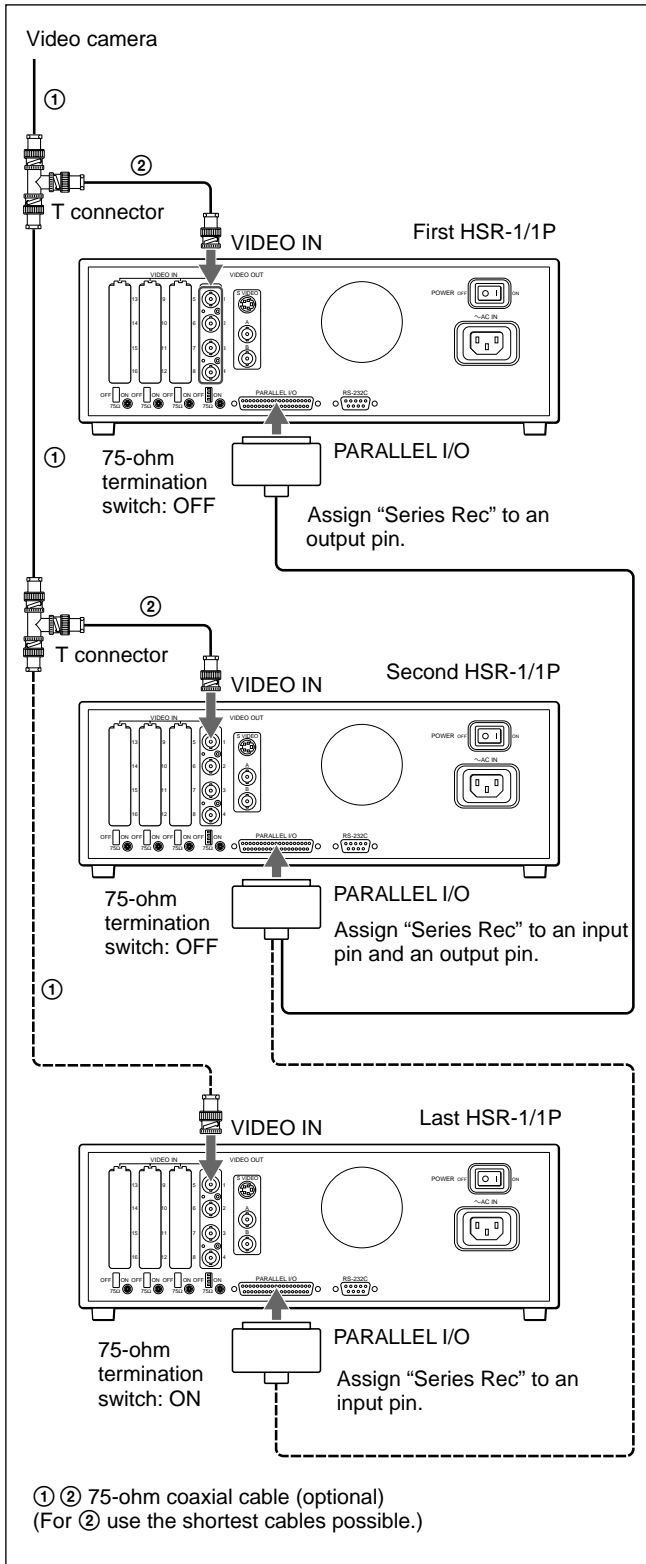

Connection for remote control

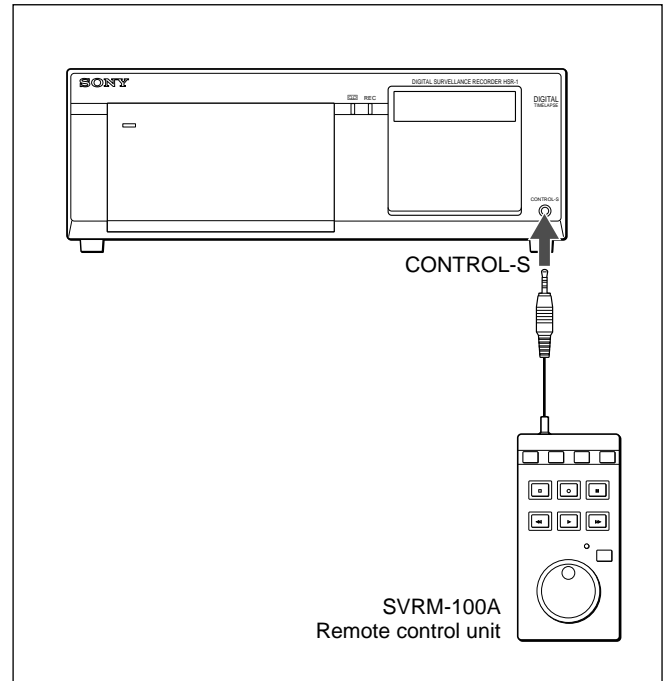

Note

When the SVRM-100A is used with this recorder, the controls are limited as follows:

Control	Function
FREEZE key	Disabled
INDEX key	Disabled
MARK key	Disabled
ERASE key	Disabled
STOP key	Same as that on the recorder
PAUSE key	Disabled
REC key	Same as that on the recorder
REW key	Same as that on the recorder
PLAY key	Same as that on the recorder
F.FWD key	Same as that on the recorder
JOG/SHUTTLE key	Sets the recorder to variable playback mode when the key is pressed during playback. The LED lights and the JOG/SHUTTLE dial is enabled.
JOG/SHUTTLE dial	Controls the speed of variable playback. The dial is valid when the LED is lit.
LED	Indicates that the JOG/SHUTTLE dial is operable.

For pin assignment of the PARALLEL I/O connector, see "Remote Control Menu" on page 4-13.

Setting the Clock

Set the time and date of the built-in clock. The time and date are recorded as data on a tape, and can be superimposed on the playback picture and used for picture search.

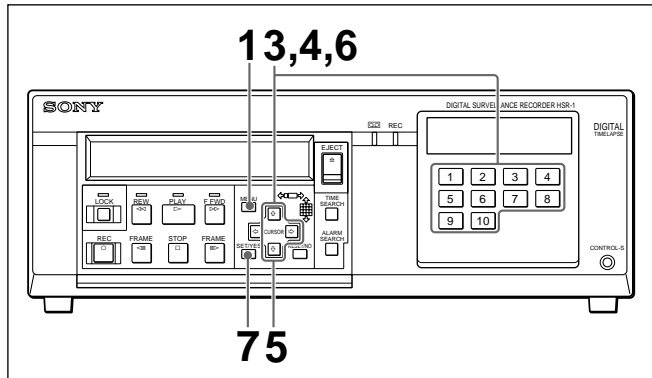

- 1 Enter Menu mode by pressing the MENU key. The Top menu appears on the monitor display.

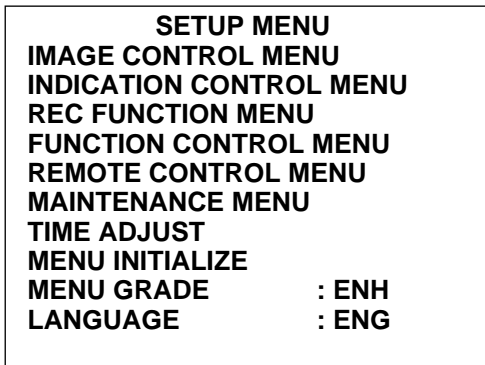

- 2 Highlight TIME ADJUST (or display "Time Adjust" on the front panel) by pressing the \uparrow or \downarrow key, then press the \rightarrow key.

The unit enters Time adjustment mode, and the column to be set flashes.

Monitor screen

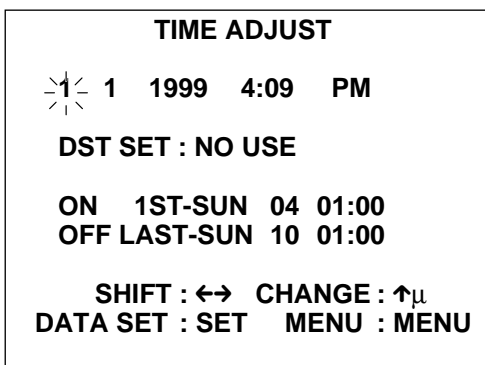

Character display



- 3 Set the date and time by advancing or retarding the value with the \uparrow or \downarrow key or by directly entering a value with the numeric keys, then press the \rightarrow key to the next column.

To switch between AM and PM, press the \uparrow or \downarrow key.

- 4 Press the SET key at a time signal.

To automatically change the clock for the daylight saving time

- 1 Highlight DST SET and select USE with the \uparrow or \downarrow key, then press the \rightarrow key.
- 2 On the ON line, select the week, day of the week and time (24H format) to change the clock.
- 3 On the OFF line, select the week, day of the week and time (24H format) to return the clock.
- 4 Press the SET key.

To cancel the setting

Press the MENU key in place of the SET key to leave the menu mode.

The format for superimposing the date/time on the playback picture can be set using the Indication Control menu.

See "Indication Control Menu" on page 4-8.

Settings

When the connections and preparations are completed, perform the system settings in Enhanced menu mode. In the following setting procedures, the indications on the character display on the front panel of the HSR-1/IP are shown in parenthesis after those on the monitor screen.

Example: IMAGE CONTROL MENU (Image Menu)

Selecting the Enhanced Menu Mode

- 1 Enter Menu mode by pressing the MENU key. The top menu appears on the monitor display. The Top menu item that had been selected when you left Menu mode the last time is displayed on the character display on the front panel.
- 2 When MENU GRADE (Menu grade) is set to BASIC (Basic), change it to ENH (Enhanced).

Top menu in Enhanced Menu mode

SETUP MENU	
IMAGE CONTROL MENU	
INDICATION CONTROL MENU	
REC FUNCTION MENU	
FUNCTION CONTROL MENU	
REMOTE CONTROL MENU	
MAINTENANCE MENU	
TIME ADJUST	
MENU INITIALIZE	
MENU GRADE	: ENH →
LANGUAGE	: ENG

Setting the Cameras to Use

Specify the cameras to be used for monitoring and recording.

Use CAMERA CONNECTION (CamConnect) of the Image Control menu for the setting.

To use connected cameras for monitoring and recording

Set the number of the camera (the same as the VIDEO IN connector number to which the camera is connected) to CONNECT.

Setting procedure

- 1 Highlight IMAGE CONTROL MENU (or display Image Menu) of the top menu by pressing the ↑ or ↓ key, then press the → key.

The Image Control menu is displayed.

SETUP MENU	
IMAGE CONTROL MENU	
A IMAGE	
B IMAGE	
CAMERA CONNECTION	
MONI DISP STRUCTURE	
PLAY DISP STRUCTURE	

- 2 Highlight CAMERA CONNECTION (or display CamConnect) by pressing the ↑ or ↓ key, then press the → key.

The menu shifts to camera connection setting. The CONNECT/NO indication for CAM 1 flashes.

CAM 1	CAM 2	CAM 3	CAM 4
CONNECT	CONNECT	CONNECT	CONNECT
CAM 5	CAM 6	CAM 7	CAM 8
CONNECT	CONNECT	CONNECT	CONNECT
CAM 9	CAM 10	CAM 11	CAM 12
CONNECT	CONNECT	CONNECT	CONNECT
CAM 13	CAM 14	CAM 15	CAM 16
NO	NO	NO	NO

- 3 Select the camera to be set by pressing the → or ← key.
Each time you press either of the key, camera 1 to 16 are cyclically selected, and the CONNECT/NO indication for the selected camera flashes.
- 4 Select CONNECT or NO by pressing the ↑ or ↓ key.

Repeat steps 3 and 4 for all the connected cameras.

5 When the settings are completed, press the SET key.

A message “NOW SAVING” is displayed, and the settings are stored in nonvolatile memory. The Image Control menu is restored.

To restore to the previous setting

Before pressing the SET key, press the MENU key. The message “ABORT !” is displayed, and the previous setting is restored.

Notes

- If an optional input board is not mounted to a slot of corresponding connector numbers, CONNECT cannot be selected for those numbers.
- When the settings of this display are changed, the settings of the monitor display structure (page 5-8) and those of the recording modes (page 5-11) are automatically changed.

SETUP MENU	
INDICATION CONTROL MENU	
BORDER LINE	: BLACK
DATE FORMAT	: M D Y
MONTH FORMAT	: NUMBER
TIME FORMAT	: 12H
FRNT TIME DISP	: TM MD
MONI CHAR TYPE	: WHITE
MONI CHAR INFO	
REC CHAR POSI	: UP LEFT
REC CHAR INFO	
CAMERA NAME	

2 Highlight CAMERA NAME (or display CameraName) by pressing the ↑ or ↓ key, then press the → key.

The menu shifts to camera name setting, and the first character of the name currently set for the camera connected to the VIDEO IN 1 connector flashes.

Setting Camera Names

You can specify desired names for connected cameras. Use CAMERA NAME (Camera Name) of the Indication Control menu for the setting.

Usable characters

You can set a name of up to 12 characters including alphabets, numerics, and some symbols. The specified names are superimposed in the picture from the cameras. CAM1 to CAM 16 are set at the factory.

Note

As the camera numbers are necessary for various setting and selecting pictures for monitoring, it is recommended that the number to be included in the name.

Setting procedure

1 Highlight INDICATION CONTROL MENU (or display Indict Menu) of the top menu by pressing the ↑ or ↓ key, then press the → key.

The Indication Control menu is displayed.

1 CAMERA	2 CAMERA	3 CAMERA	4 CAMERA
5 CAMERA	6 CAMERA	7 CAMERA	8 CAMERA
9 CAMERA	10 CAMERA	11 CAMERA	12 CAMERA
13 CAMERA	14 CAMERA	15 CAMERA	16 CAMERA

3 Select the character column to be set by pressing the → or ← key. Each time you press either key, the next column is selected, and that selected column flashes.

4 Select the desired character by pressing the ↑ or ↓ key. To insert a space, press the RESET key.

Repeat steps **3** and **4** for all the columns.

When you press the → key at the last column, the first column of the next camera now flashes. Set the names in the same manner for all the connected camera.

Settings

- When the settings are completed, press the SET key.

A message “NOW SAVING” is displayed, and the settings are stored in nonvolatile memory. The Indication Control menu is restored.

To restore to the previous setting

Before pressing the SET key, press the MENU key. The message “ABORT !” is displayed, and the previous setting is restored.

SETUP MENU	
IMAGE CONTROL MENU	
MONI DISP STRUCTURE	
4 DIVISION	<input type="checkbox"/>
6 DIVISION	<input type="checkbox"/>
7 DIVISION	<input type="checkbox"/>
8 DIVISION	<input type="checkbox"/>
9 DIVISION	<input type="checkbox"/>
10 DIVISION	<input type="checkbox"/>
13 DIVISION	<input type="checkbox"/>
16 DIVISION	<input type="checkbox"/>

Setting the Display Structures

Assign the cameras to the divisions of each divided screen for monitoring and playback. These display structures can be independently set for monitoring and playback.

In display structures for playback, you can assign not only playback cameras but also monitoring cameras. In the division to which a monitoring camera has been assigned, you can see the current picture from the camera even while playback is in progress in other divisions.

To set the monitor display structures

Use MONI DISP STRUCTURE (Moni Disp) of the Image Control menu for making the setting.

Note

When the settings on CAMERA CONNECTION (page 5-6) are changed, the settings of the display structures may be automatically changed according to the CAMERA CONNECTION settings.

- Highlight IMAGE CONTROL MENU (Image Menu) of the top menu by pressing the \uparrow or \downarrow key, then press the \rightarrow key.

The Image Control Menu (page 4-6) is displayed.

- Highlight MONI DISP STRUCTURE (Moni Disp) by pressing the \uparrow or \downarrow key, then press the \rightarrow key.

The menu shifts to monitor display structure setting.

- Highlight the desired division mode by pressing the \uparrow or \downarrow key, then press the \rightarrow key.

The setting display of the selected division mode appears on the monitor screen.

Example: 8-Division mode

1 page			CAM 2 (MON)
			CAM 3 (MON)
			CAM 4 (MON)
CAM 5 (MON)	CAM 6 (MON)	CAM 7 (MON)	NO

- Select the division to be set by pressing the \rightarrow or \leftarrow key.

Each time you press either of the keys, the next division is selected, and the indication for the selected division flash.

- Select the camera to be monitored in the selected division by pressing the \uparrow or \downarrow key.

Each time you press either keys, the camera numbers of the connected cameras and NO are cyclically selected.

You can specify the camera number by pressing the corresponding number key. Note, however, that the keys of non-connected camera numbers are disabled.

Repeat steps 4 and 5 for all the divisions.
The same camera can be assigned to multiple divisions.

When setting the structure in a dividing mode that has multiple pages, the setting display for the subsequent page will appear by pressing the \blacktriangleright key in the last (lower right) division. To return to the pervious page, press the \blacktriangleleft key in the first (upper left) division.

To set the selected division to a blank (no display) division

Set to NO.

If all the divisions of a page are set to “NO,” that page will be skipped when monitoring. Similarly, if all the divisions of a dividing structure are set to “NO,” that dividing structure will be skipped when monitoring.

- 6** When the settings are completed, press the SET key.

A message “NOW SAVING” is displayed, and the settings are stored in nonvolatile memory.
The Image Control Menu is restored.

To restore the previous setting

Before pressing the SET key, press the MENU key.
The message “ABORT !” is displayed, and the previous setting is restored.

To set the playback display structures









Use PLAY DISP STRUCTURE (Play Disp) of the Image Control menu for making the setting.

- 1** Highlight IMAGE CONTROL MENU (Image Menu) of the top menu by pressing the \uparrow or \downarrow key, then press the \blacktriangleright key.

The Image Control menu (page 4-6) is displayed.

- 2** Highlight PLAY DISP STRUCTURE (Play Disp) by pressing the \uparrow or \downarrow key, then press the \blacktriangleright key.

The menu shifts to playback display structure setting.

SETUP MENU	
IMAGE CONTROL MENU	
PLAY DISP STRUCTURE	
4 DIVISION	
6 DIVISION	
7 DIVISION	
8 DIVISION	
9 DIVISION	
10 DIVISION	
13 DIVISION	
16 DIVISION	

- 3** Highlight the desired division mode by pressing the \uparrow or \downarrow key, then press the \blacktriangleright key.

The setting display of the selected division mode appears on the monitor screen.

Example: 8-Division mode

1 page			CAM 2 (MON)
			CAM 3 (MON)
			CAM 4 (MON)
CAM 5 (MON)	CAM 6 (MON)	CAM 7 (MON)	NO

- 4** Select the division to be set by pressing the \blacktriangleright or \blacktriangleleft key.

Each time you press either of the keys, the next division is selected, and the indication for the selected division flash.

- 5** Select the camera to be monitored in the selected division by pressing the \uparrow or \downarrow key.
Each time you press either of the keys, the camera numbers of the connected cameras and NO are cyclically selected.

To assign a playback camera

Set CAM 1(PB) to CAM 16(PB).

You can also specify the camera number by pressing the corresponding number key.

To assign a monitor camera

Set CAM n (MON).

You can specify the camera number by pressing the corresponding number key. Note, however, that the camera set to NO in CAMERA CONNECTION cannot be selected.

Repeat steps **4** and **5** for all the divisions.
The same camera can be assigned to multiple divisions.

When setting the structure in a dividing mode that has multiple pages, the setting display for the subsequent page will appear by pressing the **▶** key in the last (lower right) division. To return to the pervious page, press the **◀** key in the first (upper left) division.

To set the selected division to a blank (no display) division

Set to NO.

If all the divisions of a page are set to “NO,” that page will be skipped when monitoring. Similarly, if all the divisions of a dividing structure are set to “NO,” that dividing structure will be skipped when monitoring.

- 6** When the settings are completed, press the SET key.

A message “NOW SAVING” is displayed and the settings are stored in nonvolatile memory.
The Image Control Menu is restored.

To restore the previous setting

Before pressing the SET key, press the MENU key. The message “ABORT !” is displayed, and the previous setting is restored.

Setting the Automatic Change Cycle

The picture to be monitored in Full screen (nondivided) mode can be automatically changed at the specified cycle.

You can determine whether to automatically change the picture and, if to change, the cycle independently for the VIDEO OUT A and B connectors.

The S-VIDEO connector always outputs the same signal as that from the VIDEO OUT A connector.

Use A IMAGE (A Image) and B IMAGE (B Image) of the Image Control menu.

The setting procedure is common to the A and B connectors.

To activate the automatic change function

Set MONITOR (Monitor) of A IMAGE (A Image) or B IMAGE (B Image) to AUTO (Auto).

- 1** Highlight IMAGE CONTROL MENU (or display Image Menu) of the top menu by pressing the **▲** or **▼** key, then press the **▶** key.

The Image Control menu (page 4-6) is displayed.

- 2** Highlight A IMAGE or B IMAGE (or display A Image or B Image) by pressing the **▲** or **▼** key, then press the **▶** key.

The menu shifts to corresponding setting.

Example: A Image

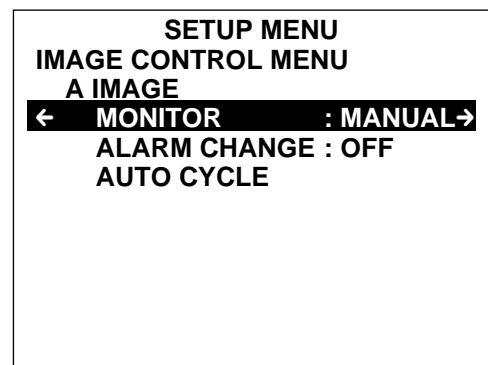

- 3** Highlight MONITOR (or display Monitor), and press the **▶** key to move to the lower layer.

Example: A Image to Monitor

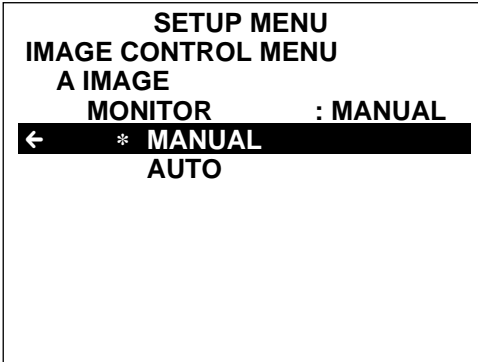

- 4** Select AUTO (Auto) by pressing the **▼** key, and return to the upper layer (in step **2**) by pressing the **◀** key.

To set the cycle for automatic change

The cycle is set to 5 seconds at the factory. You can change it in the range of 1 to 60 seconds in units of seconds.

- 1** Perform step **1** of “To activate the automatic change function,” highlight AUTO CYCLE (or display AutoCycle) in the layer of step **2**, and press the **▶** key.

The menu shifts to setting the auto change cycle.

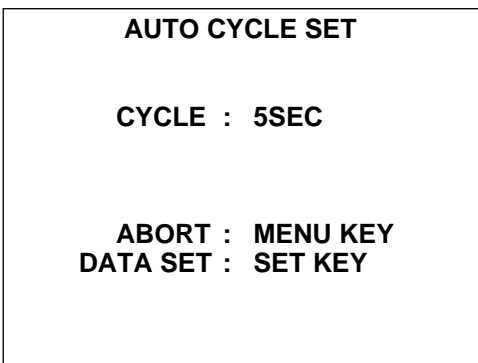

- 2** Set the cycle by pressing the **▲** or **▼** key.
- 3** When the settings are completed, press the SET key.

A message “NOW SAVING” is displayed, and the settings are stored in nonvolatile memory. The Image Control menu is restored.

To restore the previous settings

Before pressing the SET key, press the MENU key. The message “ABORT !” is displayed, and the previous settings are restored.

Setting the Recording Modes

What’s recording mode?

Up to five user-preset recording modes to this recorder. You may specify a set of recording requirements to each recording mode, such as which camera to be used and length of time to take to record on a single cassette.

Requirements specified in a recording mode:

CAMERA NUMBER: Cameras to be used for recording

TAPE LENGTH: Tape length of the cassette to be used

IMAGE QUALITY: Picture resolution

TIME MODE: Time to record on a single cassette

REC CYCLE: Time to record per camera

The settings are made with “Setting of Rec Mode” of the Recording Function menu.

To select the Recording mode setting displays

- 1** Highlight REC FUNCTION MENU of the Top menu by pressing the **▲** or **▼** key, then press the **▶** key.

The Recording Function menu is displayed.

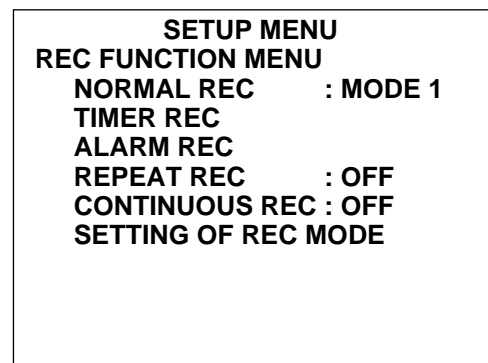

Settings

- Highlight **SETTING OF REC MODE** by pressing the **▲** or **▼** key, then press the **▶** key.

The menu shifts to selection layer of the recording mode settings.

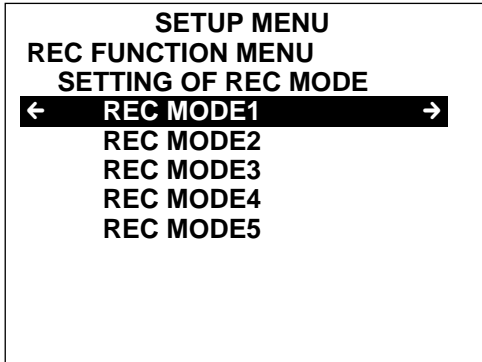

- Highlight the recording mode to be set by pressing the **▲** or **▼** key, then press the **▶** key.

The setting display for the selected recording mode appears.

Example: Setting display for Recording mode 1

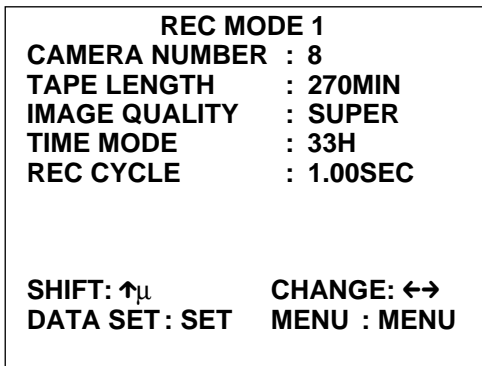

To set CAMERA NUMBER

Specify the cameras to be used for recording.

- Highlight **CAMERA NUMBER** on the setting display by pressing the **▲** or **▼** key, then press the **▶** key.

The setting display for **CAMERA NUMBER** appears, and the indication for **CAM 1** flashes.

CAM 1 - REC -	CAM 2 REC	CAM 3 REC	CAM 4 REC
CAM 5 REC	CAM 6 REC	CAM 7 REC	CAM 8 REC
CAM 9 REC	CAM 10 REC	CAM 11 REC	CAM 12 REC
CAM 13 NO REC	CAM 14 NO REC	CAM 15 NO REC	CAM 16 NO REC

- Select the camera to be set by pressing the **▶** (or **◀**) key.

Each time you press either key, the next (or the previous) camera is selected, and the indication for the selected camera flashes.

- For a camera to be used for recording, set the indication to **REC** by pressing the **▲** or **▼** key.

The cameras set to **NO REC** are not used for recording.

Repeat steps **2** and **3** for the cameras to be set.

Notes

- Only the cameras that have been set to **CONNECT** with **CAMERA CONNECTION** (page 5-5) can be set to **REC**.
- When the settings on **CAMERA CONNECTION** (page 5-6) are changed, the settings of **CAMERA NUMBER** may be automatically changed according to the **CAMERA CONNECTION** settings.

- Press the **SET** key to register your setting and return to the setting display for the recording modes.

To set other requirements

The **REC CYCLE** value is automatically calculated according to the **TAPE LENGTH** and **IMAGE QUALITY** settings. The **TIME MODE** and **REC CYCLE** settings depend on each other, and if either of them is changed, the other automatically changes in accordance.

- Select the item to be set on the recording mode setting display by pressing the **▲** or **▼** key.

2 Select the value or mode by pressing the **▶** or **◀** key.

TAPE LENGTH

Set the tape length of the cassette to be used in units of 10 minutes.

When you change the TAPE LENGTH value, the REC CYCLE value is recalculated and automatically updated.

The longer the tape length you set, the longer the recording cycle becomes.

Note

For recording, be sure to use a cassette of the same tape length specified on this menu. If a cassette of a different tape length is used, the TIME MODE indication will not match the actual recording time. The number included in the name of a DV- or DVM-series model indicates the tape length (unit: minute). (Ex.: 270 minutes with DV-270ME).

In case of a PDV- or PDVM-series model, the value obtained by multiplying the number included in the name by 1.5 corresponds the tape length (unit: minute). (Ex.: 276 minutes with PDV-184N).

TIME MODE

Set the time to record on a cassette of the specified tape length.

When you change the TIME MODE value, the REC CYCLE value is recalculated and automatically updated.

The smaller the TIME MODE value you set, the shorter the recording cycle becomes.

REC CYCLE

Set the recording cycle per camera change.

Recording is made switching all the specified camera in turn with the same specified cycle.

When you change the REC CYCLE value, the TIME MODE value is recalculated and automatically updated.

The shorter the cycle you set, the smaller the TIME MODE value becomes.

IMAGE QUALITY mode

Four IMAGE QUALITY modes (Horizontal × Vertical resolution) are available. The selected mode is used for all the specified camera.

When you change the IMAGE QUALITY mode, the REC CYCLE value is recalculated and automatically updated.

The lower the mode you select, the longer the REC CYCLE value becomes.

SUPER : 720 × 240

HIGH : 360 × 240

MID : 180 × 240

LOW : 180 × 120

To register the specified requirements

When the settings are completed, press the SET key.

A message “NOW SAVING” is displayed, and the settings are stored in nonvolatile memory. The Recording Function menu is restored.

Note

If the TIME MODE or REC CYCLE value exceeds the limit after recalculation, “*” will be displayed, and the settings will not be stored even if you press the SET key.

To restore to the previous settings

Before pressing the SET key, press the MENU key. The message “ABORT !” is displayed, and the previous settings are restored.

Setting Passwords

You can set passwords to release the key-lock function that is activated by pressing the LOCK key.

As you can classify the recorder's key functions for three levels each having a different password to release the locks, operations of the functions can be limited by the levels, such as Level 1 for the operator, Level 2 for the administrator, and Level 3 for the system manager. For the level settings, use FUNCTION LEVEL SET of the Function Control Menu (page 4-11).

Then, set the passwords using PASSWORD SET of the same menu.

To set a new password

- 1 Highlight FUNCTION CONTROL MENU (or display FuncMenu) of the top menu by pressing the \uparrow or \downarrow key, then press the \rightarrow key.

The Function Control menu is displayed.

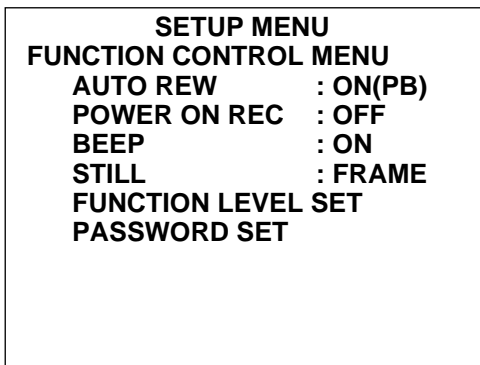

- 2 Highlight PASSWORD SET (or display Password) by pressing the \downarrow key, then press the \rightarrow key.

The menu shifts to password setting.

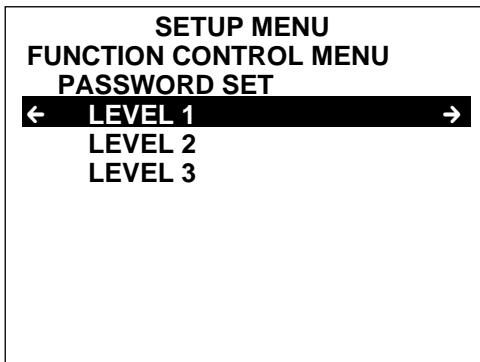

- 3 Highlight the level for which a password is to be set, then press the \rightarrow key.

The password setting display for the selected level appears.



- 4 Enter a 4-digit number from the left digit by using the numeric keys.

To enter 0, press $\boxed{10}$.

The display for the entered digit changes to * both on the monitor display and character display.

The \leftarrow key acts as a backspace key.

- 5 Press the SET key.
A request message for repeated input of the same password appears, and the number input area returns to “-----”.

- 6 Enter the same number again and press the SET key.
A message “NOW SAVING” is displayed, and the password is stored in nonvolatile memory.

Repeat steps 2 to 6 for each of the levels as required.

To change or delete the password

- 1 Call the password setting display by performing step 1 and 3 of “To set a new password.”
A message requesting the password appears, and the input area “-----” appears.

- 2 Enter the password currently set using the numeric keys and press the SET key.
The recorder enters the status in step 3 of “To set a new password.”

3 To change the password, enter a new password twice in the same manner as when you set the previous one, and press the SET key.

To delete the password, press the RESET key without entering any number.

If you forget the password

Consult your Sony dealer.

To releasing the key lock using Passwords

Press the LOCK key in key lock status (the LOCK lamp is lit).

When the password(s) have been set, a message requesting a password appears.

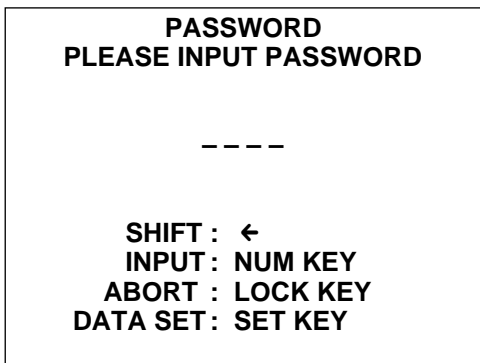

By entering a password, you can enable some or all of the locked keys.

To release the key lock of Level 1 only

Enter the password of Level 1 and press the SET key. The LOCK lamp slowly flashes¹⁾ and the functions specified for Level 1 are enabled.

To release the key lock of Levels 1 and 2

Enter the password of Level 2 and press the SET key. The LOCK lamp promptly flashes¹⁾ and the functions specified for Levels 1 and 2 are enabled.

To release the key lock completely (Levels 1 to 3)

Enter the password of Level 3 and press the SET key. The LOCK lamp goes dark, and all the recorder's functions are enabled.

To activate the key lock again

When you press the LOCK key after releasing the key lock of any level, the LOCK lamp lights and the recorder enters lock status again,

1) If no password has been specified for the higher level(s), the LOCK lamp goes out, and all the recorder's functions are enabled.

Maintenance and Troubleshooting

Maintenance

Condensation

If you move the unit suddenly from a cold to a warm location, or if you use it in a very humid place, moisture from the air may condense on the head drum. This is called condensation. If a tape is run in this state, note that the tape may stick to the drum and can be easily damaged.

Head Cleaning

Always use the DV-12CL (standard size) or DVM-12CL (mini size) Cleaning Cassette to clean the video heads. You can run the cleaning cassette for 10 seconds per cleaning operation. Follow the instructions for the cleaning cassette, as inappropriate use of the cleaning cassette can damage the heads.

Regular Checks

Digital hours meter

The digital hours meter keeps cumulative counts of the total operating time, the head drum rotation time, the tape transport operating time, and the number of threading/unthreading operations. These counts can be displayed on the monitor screen and the time counter display of this unit. Use them as guidelines for scheduling maintenance.

In general, consult your Sony dealer about necessary periodic maintenance checks.

Digital hours meter display modes

The digital hours meter has the following four display modes.

- **T1 (OPERATION) mode**
The cumulative total hours during which the unit is powered on is displayed in 10-hour increments.
- **T2 (DRUM ROTATION) mode**
The cumulative total hours of drum rotation with tape threaded is displayed in 10-hour increments.
- **T3 (TAPE RUNNING) mode**
The cumulative total hours of tape transport operation is displayed in 10-hour increments.
- **CT (THREADING) mode**
The cumulative number of tape threading/unthreading operation pairs is displayed in 10-operation pair increments.

For all modes except T1 (OPERATION), there are two types of count: a “trip” count, which is resettable, and the cumulative total from manufacture, which is unresettable.

Displaying the digital hours meter

For details on menu operations, see Chapter 4 “Menu Operations.”

- 1 Enter Menu mode by pressing the MENU key.

If MENU GRADE on the top menu is set to BASIC, change it to ENH.

- 2 Highlight MAINTENANCE MENU by pressing the \uparrow or \downarrow key, then press the \rightarrow key.

The Maintenance menu is displayed.

```
SETUP MENU
MAINTENANCE MENU
HOURS METER
VERSION DISPLAY
```

- 3 Highlight HOURS METER by pressing the \uparrow or \downarrow key, then press the \rightarrow key.

The cumulative counts by the digital hours meter are indicated on the monitor screen and the character display.

Digital hours meter indications on the monitor screen

All four counts (T1, T2, T3, and CT) are indicated on the monitor screen.

```
HOURS METER

T1      00000  x10 HOURS
T2 0000/00000  x10 HOURS
T3 0000/00000  x10 HOURS
CT 0000/00000  x10 COUNT

T1 : OPERATION
T2 : DRUM ROTATION
T3 : TAPE RUNNING
CT : THREADING
```

The four-digit value to the left of the slash is the resettable trip count, and the right value is the cumulative total from manufacture.

Digital hours meter indications on the character display

One of the hour indications appears on the character display at a time. Use the \uparrow and \downarrow keys to change the item displayed.

Initially, only the trip value appears. Hold down the \rightarrow key to display also the cumulative total from manufacture, which will appear to the right of the trip value and the slash.

The following illustrates the digital hours meter indications on the character display in all four display modes. The right-hand indication for each display mode is the indication you can view while holding down the **▶** key.

T1 (OPERATION) mode:

Oper. 00000	
-------------	--

T2 (DRUM ROTATION) mode:

Drum 0000	0000/00000
-----------	------------

T3 (TAPE RUNNING) mode:

Tape 0000	0000/00000
-----------	------------

CT (THREADING) mode:

Thread 0000	0000/00000
-------------	------------

To end the digital hours meter display

Press the MENU key.

Resetting the trip values

About this operation, consult your Sony dealer.

Troubleshooting

If some alarm message appears on the monitor screen or the character display, or if the unit appears to be

malfunctioning, please check the following before contacting your Sony Dealer.

Symptom	Cause	Remedy
Recording is not possible.	The cassette's REC/SAVE switch is set to SAVE.	Set the REC/SAVE switch to REC.
The tape transport keys do not work.	The key lock function is active.	Press the LOCK key to cancel the key lock function. When a password has been specified, enter the password (see page 5-14).
	No cassette is loaded.	Insert a cassette.
Picture from a camera cannot be monitored.	The "CAMERA CONNECTION" setting of the camera is "NO" (the corresponding camera number/numeric key is dark).	Set "CAMERA CONNECTION" of the Image Control Menu for the desired camera to "CONNECT" (see page 5-6).
	No video signal is being supplied to the corresponding camera input (the corresponding camera number/numeric key flashes).	Supply an appropriate video signal.
Picture from a camera cannot be monitored on a divided screen.	The corresponding camera number has not been specified in "MONI DISP STRUCTURE" (the corresponding camera number/numeric key does not light in amber).	Assign the number of the desired camera to a divided screen in "MONI DISP STRUCTURE" of the Image Control Menu (see page 5-8).
Power is not turned off even if timer recording is activated.	This recorder remains on even when recording specified by timer recording is not in progress.	

Error Codes and Messages

This unit is provided with a self-diagnosis function that detects internal errors. When it detects an error, it

outputs an error message to the monitor screen and indicates an error code in the character display.

Code	Message	Meanings
00-001	ERROR 00-001 AN ERROR DETECTED IN TAPE BLOCK.	An error detected in the tape block in a mode other than recording.
	ERROR 00-001 AN ERROR DETECTED IN TAPE BLOCK.	An error detected in the tape block during recording.
00-010	ERROR 00-010 RECORDING FAILED. RECORDING IS CONTINUED ON HARD DISK.	Recording fails for some reason, such as system data reading failure.
60-00*	ERROR 60-00* ¹⁾ AN ERROR DETECTED IN HARD DISK.	An error detected in the hard disk in a mode other than recording.
	ERROR 60-00* ¹⁾ AN ERROR DETECTED IN HARD DISK. RECORDING IS CONTINUED ON TAPE.	An error detected in the hard disk during recording.
40-011	ERROR 40-011 CAMERA 1 - 4 RECORDING FAILED.	Signals from camera 1 to 4 cannot be recorded.
40-012	ERROR 40-012 CAMERA 5 - 8 RECORDING FAILED.	Signals from camera 5 to 8 cannot be recorded.
40-013	ERROR 40-013 CAMERA 9 - 12 RECORDING FAILED.	Signals from camera 9 to 12 cannot be recorded.
40-014	ERROR 40-014 CAMERA 13 - 16 RECORDING FAILED.	Signals from camera 13 to 16 cannot be recorded.
40-015	ERROR 40-015 AN ERROR DETECTED IN DA.	Picture to be output cannot be correctly updated.
90	ERROR 90 (displayed only on the character display of this recorder)	The recorder is not operating properly.
92-013	ERROR 92-013 COMMUNICATION ERROR WITH PANEL KEY BLOCK.	Serial communication error between CPU and the KY board.
92-014	ERROR 92-014 COMMUNICATION ERROR WITH TAPE BLOCK. RECORDING IS CONTINUED ON HARD DISK.	Serial communication error between CPU and the tape block.
97-002	ERROR 97-002 ILLEGAL MENU SETTING. INITIALIZE THE MENU SETTING.	Sum error detected in the menu data loaded from EEPROM.

- 1) 001: Cannot access the register.
002: Cannot access the data.

Appendices

Notes on Use

Operation and storage locations

Avoid operation or storage in any of the following places.

- Location subject to extremes of temperature (operating temperature range 5°C to 40°C (41°F to 104°F))
- Location subject to direct sunlight for long periods, or close to heating appliances (Note that the interior of a car left in summer with the windows closed can exceed 50°C (122°F).)
- Damp or dusty places
- Location subject to severe vibrations
- Location near equipment generating strong electromagnetic emissions
- Location near transmitting stations generating strong radio waves

Operate the unit in a horizontal position

This unit is designed to be operated in a horizontal position. Do not operate it on its side, or tilted through an excessive angle (exceeding 20°).

Avoid violent impacts

Dropping the unit, or otherwise imparting a violent shock to it, is likely to cause it to malfunction.

Do not obstruct ventilation opening

To prevent the unit from overheating, do not obstruct ventilation openings, by for example wrapping the unit in a cloth while it is in operation.

Care

If the casing or panel is dirty, wipe it gently with a soft dry cloth. In the event of extreme dirt, use a cloth steeped in a natural detergent to remove the dirt, then wipe with a dry cloth. Applying alcohol, thinner, insecticides, or other volatile solvents may result in deforming the casing or damaging the finish.

Shipping

Pack the unit in its original carton or equivalent packing, and take care not to impart violent shocks in transit.

Specifications

General

Power requirements	
HSR-1:	AC 100 to 120 V, 50/60 Hz
HSR-1P:	AC 220 to 240 V, 50/60 Hz
Power consumption	80 W (without options) 115 W (with full options)
Operating temperature	5°C to 40°C (41°F to 104°F)
Storage temperature	-20°C to +60°C (-4°F to +140°F)
Operating humidity	Less than 80%
Storage humidity	Less than 90%
Mass	10 kg (22 lb 1 oz)
Dimensions	355 × 125 × 410 mm (w/h/d) (14 × 5 × 16 1/4 inches) not including the projecting parts

System

Video signal	
HSR-1:	EIA standard, NTSC color
HSR-1P:	CCIR standard, PAL color
Recording system	Rotary two-head helical scanning system Digital components
Tape format	Based on DV format (SD standard)
Usable tape	DV cassettes (standard size, mini size)
HDD	More than 4.3 GB
Quantization	8 bits
Sampling frequency	
HSR-1:	13.5 MHz (4:1:1 components)
HSR-1P:	13.5 MHz (4:2:0 components)
Recording/Playback time	Maximum 9999 hours
Fast forward/Rewind time	Less than 3 minutes (with a DV270 cassette)

Video

Input	VIDEO IN connectors (BNC type) (4) VBS or VS signals: 1.0 Vp-p ±0.2 V, 75 ohms, unbalanced
Output	VIDEO OUT A/B connectors (BNC type) (2) VBS signal: 1.0 Vp-p ±0.2 V, 75 ohms, unbalanced

S-VIDEO connector (4-pin) (1)
Y signal: 1.0 Vp-p ±0.2 V, 75 ohms, unbalanced
C signal: 0.28 Vp-p ±0.06 V (HSR-1), 0.30 Vp-p ±0.06 V (HSR-1P), 75 ohms, unbalanced

Horizontal resolution	500 TV lines (SUPER mode)
Signal-to-noise ratio	48 dB or more

Built-in Multiplexer

Input	4 inputs (up to 16 inputs with optional boards)
Output	2 outputs
Split screen display	8 patterns

Control connectors

Parallel input/output	PARALLEL I/O connector (D-sub 37-pin) (1) Input: 24 terminals to be freely assigned Output: 8 terminals to be freely assigned Power output: +12V (max. 100 mA)
RS-232C	D-sub 9-pin (1)
Control S input	CONTROL-S connector (stereo mini jack) (1)

Supplied Accessories

AC power cord (1)
Multi connector (1)
DV-270ME cassette (1)
Operation manual (1)

Optional Accessories

HSRA-11 (Input board)
SVRM-100A (Remote control unit)

Design and Specifications are subject to change without notice.

A

A IMAGE 4-6
AC IN connector 1-7
ALARM indication 1-6
ALARM REC 3-5, 4-10
Alarm recording 3-4
 activate 3-6
 cancel 3-6
 mode 3-4
 set 3-5
Alarm search 3-10
 cancel 3-10
 execute 3-10
ALARM SEARCH key 1-6, 3-10
AUTO REW 4-11
Automatic change cycle 5-10

B

B IMAGE 4-6
BEEP 4-11
Border line 2-3
BORDER LINE 4-8

C

Cancel condition (alarm recording) 3-5
Cassette indicator 1-4, 2-2
CAMERA CONNECTION 4-7, 5-6
Camera name
 display 1-8
 setting 5-7
CAMERA NAME 4-9, 5-7
Camera number/numeric keys 1-4, 4-2
Cameras to use 5-6
Cassette tape
 loading 2-2
 preventing accidental erasure 2-2
 slack checking 2-1
 unloading 2-2
 usable cassettes 2-1
Character display 1-6
Clock 5-5
Condensation 6-1
Connections
 remote controls 5-1, 5-4
 series recording 5-4
 video cameras 5-1, 5-2
 vidco monitors 5-1, 5-2
CONT indication 1-6, 3-8
CONTINUOUS REC 3-8, 4-10

Continuous recording
 activate 3-8
 cancel 3-8
CONTROL-S connector 1-4
CURSOR key 1-5, 4-2

D

Data recording 2-7
DATE FORMAT 4-8
Date/time indication 1-8
Display structure 5-8
 monitor display structure 5-9
 playback display structure 5-9
Dividing the screen 2-3
DV cassette 2-1
DVM cassette 2-1

E

EJECT button 1-4, 2-2
Enhanced menu mode 5-6
Error codes and messages 6-5
EVENT mode (alarm recording) 3-4

F

F FWD key and indicator 1-5
FRAME key 1-5
FRAME mode (alarm recording) 3-5
FRNT TIME DISP 4-8
Front panel 1-4
FUNCTION CONTROL menu 4-11
FUNCTION LEVEL SET 4-11

H

HDD recording/playback 3-12
Head cleaning 6-1
High-speed playback 3-12
Hours meter 6-2
HOURS METER 4-15, 6-2

I

IMAGE CONTROL menu 4-6
Image quality mode
 display 1-8
 set 5-13
INTERLEAVE mode (alarm recording)
 3-4

L

LANGUAGE 4-5
LOCK key and indicator 1-5

M

MAINTENANCE menu 4-15
Menu
 basic display layout 4-2
 grade 4-4
 initializing 4-4
 keys used for operation 4-2
 language selection 4-2
 layered structure 4-1
 setting the items 4-3
MENU GRADE 4-5
MENU INITIALIZE 4-5
MENU key 1-5, 4-2
MONI CHAR INFO 4-9
MONI CHAR POS 4-8
MONI CHAR TYPE 4-8
MONI DISP STRUCTURE 4-7, 5-8
MONTH FORMAT 4-8

N

NORMAL mode (alarm recording) 3-4
Normal playback 2-9
NORMAL REC 4-10
Normal recording 2-5
Numeric keys (see camera number keys)

O

Opening for cassette compartment
 1-4, 2-2

P

PARALLEL INPUT 4-13
PARALLEL I/O connector 1-7, 5-1, 5-3
PARALLEL OUTPUT 4-14
PARALLEL OUT VOLTAGE 4-14
Password 5-14
PASSWORD SET 4-12, 5-14
PDV cassette 2-1
PDVM cassette 2-1
Picture
 automatically switch pages 2-4
 select a divided screen 2-4
 select a specific camera 2-4
 switching 2-4

Index

PLAY DISP STRUCTURE 4-7, 5-9

PLAY key and indicator 1-5

Playback 2-9

- advance at a high speed 2-9
- advance by one frame 2-9
- reverse at a high speed 2-9
- reverse by one frame 2-9
- stop 2-9

POWER switch 1-7

POWER ON REC 4-11

PREALARM mode (alarm recording) 3-4

R

Rear panel 1-7

REC CHAR INFO 4-9

REC CHAR POSI 4-9

REC FUNCTION menu 4-10

REC indicator 1-4

REC key 1-5

Recording 2-6

- execute 2-6

Recording cycle

- display 1-8
- set 5-13

Recording modes 2-5

- display 1-8
- select 2-5
- setting 5-11

Remote controls 5-1

REPEAT indication 1-6, 3-7

REPEAT REC 3-7, 4-10

Repeat recording 3-7

- activate 3-7
- cancel 3-7

RESET/NO key 1-6, 4-2

REW key and indicator 1-5

RS232C 4-13

RS-232C connector 1-7

S

S-VIDEO connector 1-7

Search speed 2-10

Series recording 3-9

- activate 3-9
- cancel 3-9

SET/YES key 1-5, 4-2

SETTING OF REC MODE 4-10, 5-11

STILL 4-11

STOP key 1-5

T

Tape length 5-13

Tape remaining indication 1-6

TIME ADJUST 4-5, 5-5

Time data indication 1-6

TIME FORMAT 4-8

Time mode

- display 1-8
- set 5-13

Time search 2-10

TIME SEARCH key 1-6, 2-10

TIMER indication 1-6

TIMER REC 3-2, 4-10

Timer recording 3-1

- activate 3-3
- cancel 3-3
- set 3-1

Top menu 4-5

V

VERSION DISPLAY 4-15

Video cameras 5-1

VIDEO IN connectors 1-7

VIDEO IN 75-ohm termination

- switch 1-7

Video monitors 5-1

VIDEO OUT connectors 1-7

