

SAMSUNG

iPOLiS

Real-time Network Dynamic 10X

Pan & Tilt



10X PTZ Network Camera **SNP-1000A** User's Manual

Thank you for purchasing a SAMSUNG iPOLiS Network Camera.
Before attempting to connect or operate this product,
please read these instructions carefully and save this manual for future use.

ENGLISH

iPOLiS

A brand that is integrated into Samsung's network products, ***iPOLiS*** stands for a convenient world (Polis) made safe (Police) through Samsung's superior network performance(Internet protocol). With ***iPOLiS*** products' clear digital images transmitted over the internet, real-time monitoring is possible anywhere with an internet connection. Easy remote control functions and the use of existing networks minimize installation costs. With ***iPOLiS***, experience a world of convenience connected anytime, anywhere.

Preface

Thanks for purchasing of 10X PTZ Network Camera SNP-1000A.

This is a user instruction manual for a 10X PTZ Network Camera SNP-1000A that employs Samsung Techwin's WINNER III DSP system with superior low light capability.

The user who installs and operates the product shall be aware of this manual and other manuals referenced by this manual before the installation and operation and use properly.

This manual and the software and hardware explained here are protected by copyright law.

So the copy, reprint and translation to other languages of a part of or all contents of this user manual without permission of SamsungTechwin Co., LTD are not allowed except for the copy for general use within the scope of copyright law.

Contents

Preface	i
Contents	1
Note to User	5
Product Warranty and Limitations	8
Warning Symbols	9
Danger	9
Caution	11
Ch1. Overview	13
1.1. 10X PTZ Network Camera SNP-1000A Introduction	14
1.2. Features	14
Ch2. Section names and functions	17
2.1. Body	18
2.2. Rear panel	18
2.3. Connection to external terminal	19
Ch3. Installation and Network Setup	21
3.1. Components and Accessories	22
3.2. Installation	23
3.2.1. Preparation for Cable	23
3.2.2. Cable Connection	24
3.2.3. Installation of SNP-1000A	26
3.2.4. Installing the SNP-1000A on a Ceiling	27
3.2.5. Installing the SNP-1000A Wall Mount	29
3.2.6. Installing the Dome Housing (STH-1000PI)	31

3.3. Network configuration and connection method	32
3.3.1. Configuration/connection using Web page	32
Ch4. How to Use Web Viewer.....	37
4.1. How to Use Web Viewer.....	38
4.1.1. Login	38
4.1.2. Web Viewer screen	39
4.1.3. Area Zoom guide.....	45
4.2. Using Administration page.....	49
4.2.1. Initialization Screen after Connecting	49
4.2.2. Live	50
4.2.3. Basic	51
4.2.4. Network.....	53
4.2.5. User	54
4.2.6. Pan/Tilt/Zoom.....	57
4.2.7. Motion Detection	59
4.2.8. Alarm/Sensor	60
4.2.9. Time	63
4.2.10. LOG	64
4.2.11. Upgrade	65
4.2.12. System Reboot.....	66
Ch5. How to Operate Camera.....	67
5.1. OSD Menu Organization	68
5.2. PTZ Camera User Menu Settings	71
5.2.1. Camera Setting	71
5.2.2. FOCUS	71
5.2.3. White Balance.....	73

5.2.4. Exposure.....	75
5.2.5. Back Light	76
5.2.6. AGC	77
5.2.7. SSNR (Samsung Super Noise Reduction)	77
5.2.8. Day & Night.....	78
5.2.9. Others	79
5.3. Sequence Setting	80
5.3.1 Preset	80
5.3.2. Swing SEQ.....	82
5.3.3. Group SEQ	83
5.3.4. Tour SEQ	83
5.3.5. PTZ Trace	84
5.3.6. Auto Run	85
5.3.7. Power On Resume.....	86
5.4. P/T Setting.....	87
5.4.1. Pan Limit.....	87
5.4.2. Tilt Limit.....	87
5.4.3. Area Setting	88
5.4.4. Area Masking	89
5.4.5. Prop. P/T.....	89
5.4.6. Digital Flip	90
5.4.7. Jog Speed	90
5.5. OSD Setting	91
5.5.1. Camera Name.....	91
5.5.2. Preset Number	92
5.5.3. Preset Name	92
5.5.4. Sequence Status	93

5.5.5. Area Name	93
5.5.6. PTZ Position	94
5.5.7. Language	94
5.6. Initialization Setting	95
5.7. Status.....	96
Ch6. Troubleshooting	97
Appendix A. DDNS Usage.....	101
Specifications	109
Dimension	112



Note

If you refer to the enclosed Quick guide and the Manual in the CD, you can learn how to use Network Manager Standard.

Note to User

This machine's electromagnetic waves have been registered as suitable for business purposes; the retailer and consumer should be aware of this registration. If in the case of wrongful purchases, please exchange the product for a home use product.



Correct Disposal of This Product

(Waste Electrical & Electronic Equipment)

(Applicable in the European Union and other European countries with separate collection systems)

This marking shown on the product or its literature, indicates that it should not be disposed with other household wastes at the end of its working life. To prevent possible harm to the environment or human health from uncontrolled waste disposal, please separate this from other types of wastes and recycle it responsibly to promote the sustainable reuse of material resources. Household users should contact either the retailer where they purchased this product, or their local government office, for details of where and how they can take this item for environmentally safe recycling. Business users should contact their supplier and check the terms and conditions of the purchase contract. This product should not be mixed with other commercial wastes for disposal.



Samsung Techwin cares for the environment at all product manufacturing stages to preserve the environment, and is taking a number of steps to provide customers with more environment-friendly products. The Eco mark represents Samsung Techwin's will to create environment-friendly products, and indicates that the product satisfies the EU RoHS Directive.



FCC Compliance Statement

Caution : Any changes or modification in construction of this device which are not expressly approved the party responsible for compliance could void the user's authority to operate the equipment

Note : This equipment has been tested and found to comply with the limits for a Class a digital device, pursuant to part 15 of the FCC Rules. These limits are designed to provide reasonable protection against harmful interference when the equipment is operated in a commercial environment. This equipment generates, uses, and can radiate radio frequency energy and, if not installed and used in accordance with the instruction manual, may cause harmful interference to radio communications. Operation of this equipment in a residential area is likely to cause harmful interference in which case the user will be required to correct the interference at his own expense.



Correct disposal of batteries in this product

(Applicable in the European Union and other European countries with separate battery return systems.)

This marking on the battery, manual or packaging indicates that the batteries in this product should not be disposed of with other household waste at the end of their working life. Where marked, the chemical symbols Hg, Cd or Pb indicate that the battery contains mercury, cadmium or lead above the reference levels in EC Directive 2006/66. If batteries are not properly disposed of, these substances can cause harm to human health or the environment.

To protect natural resources and to promote material reuse, please separate batteries from other types of waste and recycle them through your local, free battery return system

WARNING : Changes or modifications not expressly approved by the manufacturer could void the user's authority to operate the equipment.

WARNING : To prevent electric shock and risk of fire hazards:

Do NOT use power sources other than that specified.
Do NOT expose this appliance to rain or moisture.

This installation should be made by a qualified service person and should conform to all local codes.

Product Warranty and Limitations

The manufacturers of this product do not take any responsibility for this product; therefore, the manufacturer does not authorize the third-party, but allows that retailer is responsible.

The product warranty does not extend to cover accidents, negligence, abuse, or wrongful use for the whole or any part of the product. Additionally, the manufacturer does not provide warranty for any additional parts or affiliations.

The warranty is for one year from the purchase date. During the period, warranty does not extend to malfunction in these areas.

- Malfunction due to user's negligence
- Dismantlement or replacement by the user
- Connection to alternate power source
- Malfunction due to natural disasters (fire, flood, tsunami, etc.)
- Replacement due to wear and tear
- Instability of network

Warning Symbols

Before attempting to connect or operate this product, please read these instructions carefully and save this manual for future use.

**Danger :**

Misuse or wrongful operation of the product may result in death, injury or bring about other fatal results. It indicates absolute caution when operating.

**Caution :**

Misuse or wrongful operation of the product may result in slight injury or damage to the product. It indicates caution when operating.

**Note :**

Indication that the user needs to be aware of certain matters, or will find matters helpful in operating the product.

Danger



Before Setup

- Please set up the proper voltage before connecting to power source.
- Please be sure the power is turned off before setup.

- There is risk of shock or fire; be sure to avoid setup in places with high humidity.
- To prevent shocks, please connect the ground wire.
- Do not install the camera on a surface that can not support it.
- Unless the surface is suitable, it could cause falling or other hazards.

During Use

- When opening the product cover, there is a risk of electric shock. Only a professional should open the cover.
- Please use only in an environment with standard temperature and humidity.
- Please do not plug in multiple products to a power source; it is often the cause of fires.
- Please do not place water or heavy objects on the product; it is often a cause of malfunction.
- Please do not use in a location with propane gas, gasoline or other flammable substances to avoid risk of explosion or fire.
- Please do not touch the power plug with wet hands to avoid electric shock.
- Do not pull on the power plug with too much force; a damaged plug may cause electric shock or fires.
- Don't connect the RJ-45 cable to a terminal by constraint.
- Stop using your camera when you find a malfunction.
If you use your camera around smoke or unusual heat for a long time, Fire may be caused.

- Random replacement of built-in battery by other types of batteries may cause explosion. The battery shall be replaced by the same battery. The lithium battery incorporated in this product is not user replaceable. Replacement of the lithium battery will be done by a trained technician.
For information on its replacement, please contact your service provider.
- The used batteries shall be disposed carefully because they can cause environment pollutions.

Disassembly and Cleaning

- There is a risk of malfunction, shock or other dangers. Please do not disassemble or attempt to fix the product.
- To prevent malfunction or shock, please do not use a wet cloth or oil-based cleaning product to clean the product exterior. Clean the exterior of the product with a dry cloth.

Caution



- Do not install under extreme temperature conditions
Use only under temperature conditions between -0°C and $+40^{\circ}\text{C}$. Provide good ventilation when using in high temperature conditions.

- Do not install under unstable lighting conditions.
Severe lighting changes or flickering may hinder normal camera operation.
- Do not drop the camera or subject it to physical shock.
May cause a product malfunction.
- Never keep the camera face to strong light directly.
May damage the CCD.
- Avoid touching the camera lens.
The lens is the most important component of the camera. Be careful not to smear it with fingerprints.
- Do not expose the camera to rain or other types of liquids
Wipe dry any liquids. Liquids may contain minerals that are corrosive to Electronic components.
- Do not expose the camera to radioactivity.
Radioactivity exposure may damage the CCD.
- Do not disassemble the camera.
If you disassemble the product as you please, a Repair Center doesn't repair it for free.
- Please check the created network place first, before trying to connect to a network.
- Please use only the power adapter that is provided with the product.
- Please check national laws to be sure that using the product for monitoring purposes is not illegal.

Ch1. Overview

1.1. 10X PTZ Network Camera SNP-1000A Introduction

The SNP-1000A is a high-tech network camera that uses MPEG-4 codec technology to allow high compression rates and clear picture quality by allowing for high frame rates to be transmitted through the network.

By using the network, remote connection, monitoring, and control is possible from any location for simple use; additionally, set-up requires only a network.

The 10X PTZ Network Camera SNP-1000A utilizes embedded software solutions (Embedded Web Server, Embedded Streaming Server, Network Protocol) developed by SamsungTechwin, and guarantees performance and safety while offering various solutions through Internet integration.

1.2. Features

○ 10X Zoom Lens with Auto-Focus Function

The 10X zoom lens having Auto-focus function magnifies the image up to 100 times when used with the digital 10X zoom function.

○ Variable Auto Surveillances

- **Individual Preset Saving Modes**

12 camera adjustment functions can be saved independently in each Preset menu to provide optimum images.

- **PTZ Trace**

4 patterns which are set up by users can be saved and replayed.

- **Auto Swing**

Pan or Tilt is operated in sequence between 2 designated positions.

- **Group Search**

Maximum 128 Preset positions are toured in order.

- **Tour Search**

Maximum 6 Group Search functions are toured in order.

- **Proportional P/T**

Even when the Zoom-In function is On for the Pan and Tilt speed correction function linked to the zoom position, fine manual operation is possible. functions are toured in order.

- **Day & Night**

Day & Night function of ICR (IR Cut-Filter Removal) and Sens-Up function can achieve optimum images during day and night.

- ※ Sens-Up function improves the CCD sensitivity by lengthening the exposure time using electricity.
- ※ Day&Night function enables users to select and adjust the colour and black and white images according to the light level. ions are toured in order.

- **OSD (On Screen Display)**

Items such as Camera ID, Camera Name, Preset Number, Preset Name, Area Name and Camera Status are displayed on the monitor. Camera functions can be set up on the OSD menu screen.

○ **128 Preset Position**

A maximum of 128 Preset positions can be set up. This function enables users to set up the monitoring place any time.

○ **Digital Flip**

When you want to monitor the moving object below the camera, you can execute the Digital Flip. The moving object can be monitored without screen reverse.

○ **Area Masking**

For privacy protection, a maximum of 4 areas can be masked among the surveillance areas preventing them to be displayed on the screen.

○ **High Data Compression Ratio**

Its data transfer speed is very fast with high data compression ratio based on MPEG-4 and it transfers relatively high frame number at the same network bandwidth.

○ **Area Zoom**

This zooming function supports image expansion of square area by mouse dragging.

Function execution is easy only with mouse operation.

Just one time clicking completes PTZ position adjustment at Area Zoom mode.

Ch2. Section names and functions

2.1. Body

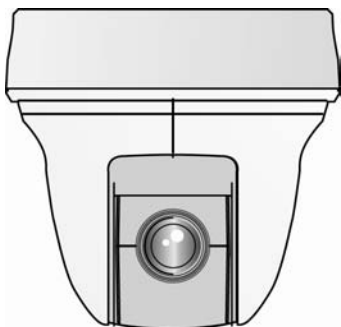

2.2. Rear panel

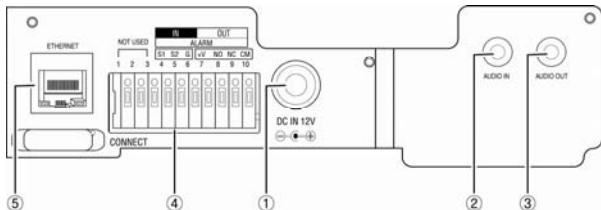

- ① Power Connector
- ② Audio Input Connector
- ③ Audio Output Connector
- ④ Alarm Input/Output Connector
- ⑤ Network Connector

2.3. Connection to external terminal

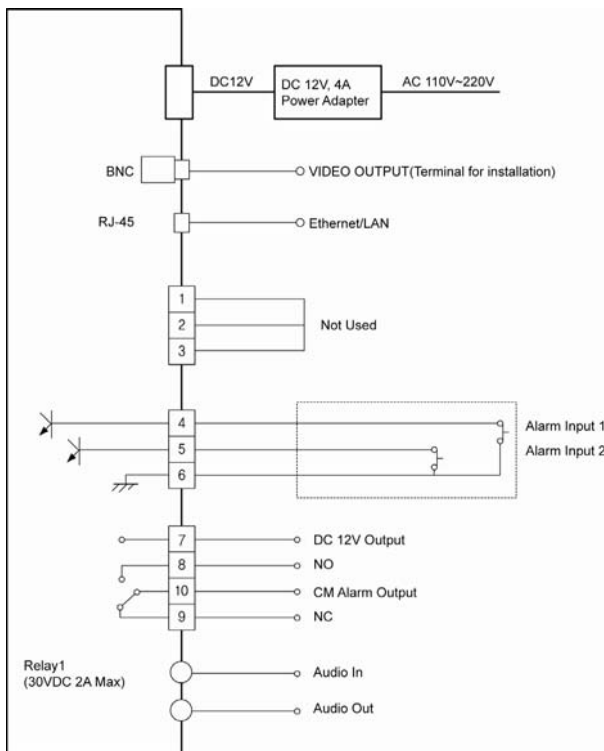

Alarm Connection Terminal

PIN NO.	NAME	Purpose
#1	-	Not Used.
#2	-	Not Used.
#3	-	Not Used.
#4	S1	Alarm Input 1
#5	S2	Alarm Input 2
#6	G	GND
#7	+V	DC 12V
#8	NO	Alarm Output(NO)
#9	NC	Alarm Output(NC)
#10	CM	Alarm Output(COM)

Ch3. Installation and Network Setup

3.1. Components and Accessories

■ Accessories



■ Products Sold Separately

The following products are provided separately.

- Accessory Housing
 - Wall Type Mount : STB-280PW
 - Wall Type Mount : STB-230PW
 - Dome Housing : STH-1000PI



Note

- See pages 26 for product images.
-

3.2. Installation

3.2.1. Preparation for Cable

To install and use the SNP-1000A, the following cables should be used.

- Power Adapter Cable

The cable connected to the power input terminal of SNP-1000A is shown below with a rated voltage of DC 12V 4A.

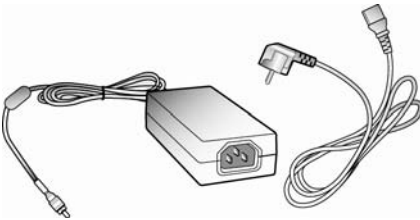

- Video Cable

The BNC cable shown below is connected to the video output terminal and the monitor of SNP-1000A.

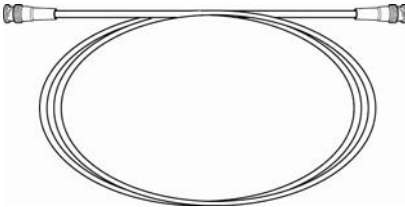

- Lan Network Cable

The cable connected to the network device of SNP-1000A for Network communication is shown below.

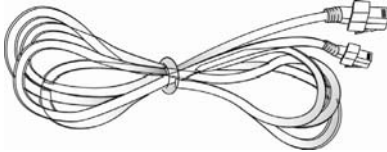

- Video cable and LAN network cable are not provided in this product's package.
 - BNC connection terminal can optionally be used to connect when the Analog output is necessary.
-

3.2.2. Cable Connection

1. First, connect one end of the BNC video cable connector to the Video Output Terminal.
2. Next, connect the other end of the connector to the Video Input Terminal of the monitor.

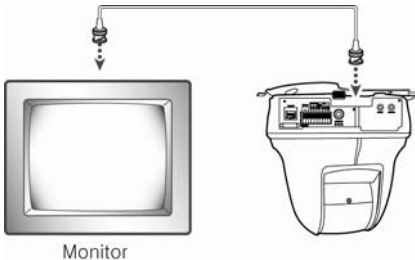

- For the network connection of the SNP-1000A, connect the LAN Cable as the figure below shows.

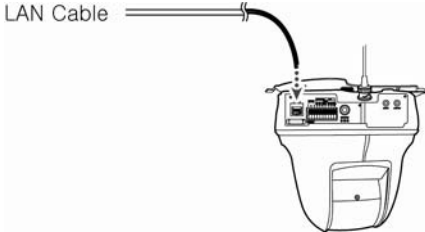

- Then, connect the Power Adapter Cable. Use a driver (-) to screw one part of the Power Adapter consisting of two lines to the Power Input Terminal of the camera holder.

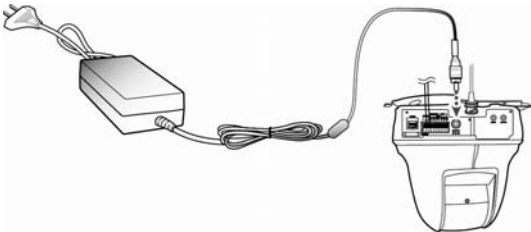

- Connect the Power Adapter's plug to the Power Outlet.

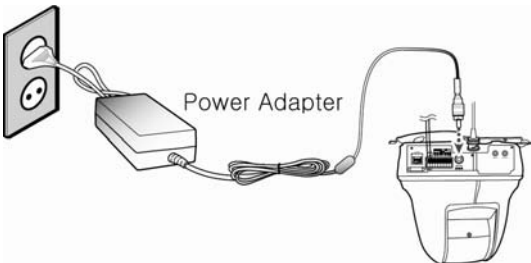

3.2.3. Installation of SNP-1000A

■ Precautions for Installation

- Check that the installation location can safely bear four times the weight of the camera and its installation fittings.
- When fixing the ceiling installation bracket, use the supplied installation template and fixing screws.
- Take care not to drop the product during installation. Do not allow anyone to stand below the installation area.

■ Optional Products for Installation

- Wall Mount (STB-280PW)

This housing is used to install the camera on an indoor wall or ceiling using an external conduit.



- Wall Mount(STB-230PW)

This housing is used to install the camera on an indoor wall.

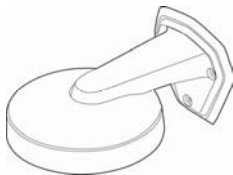

- Dome Housing (STH-1000PI)

This housing is used to install the camera in a location that is dusty, or a place where extra protection for the camera is required.



3.2.4. Installing the SNP-1000A on a Ceiling

1. Prepare the accessories in the camera box (power adapter, installation template, audio extension cable, 1 loose-proof screw, 3 installation bracket fixing screws, 2 installation brackets, installation cover, installation CD) and a tool for making a hole in the ceiling.

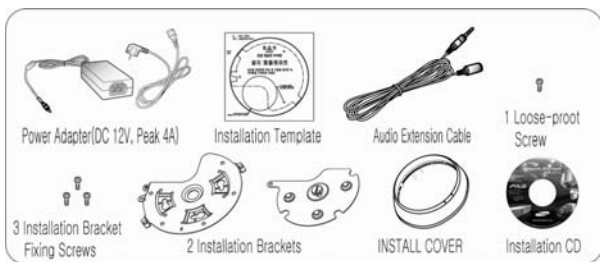

2. Attach the installation template to the ceiling where you want to install the camera, make a hole of at least 65mm in diameter, and 3 holes for fixing screws according to the marks on the template, and pull the external incoming cables out of the hole.

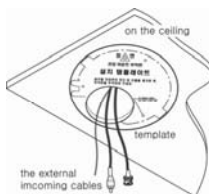

Caution

Precautions before Attaching the Installation Template

- Installation Location: Check that the function and performance of the camera installed on the ceiling will not be adversely affected by the external environment, and that the ceiling can adequately support the weight of the camera.
- Installation Direction: Determine the main direction of the camera in advance and attach

the template so that the front of the template is in line with the camera direction.

- **Caution:** Since there is a danger of the product falling during installation, take care not to allow anyone to stand below the installation area.

3. Align the arrow on the ceiling attachment installation bracket with the front of the template, fix the bracket by fastening the 3 screws through the holes, and connect the external incoming cables (video cable, network cable and power cord) to the camera.

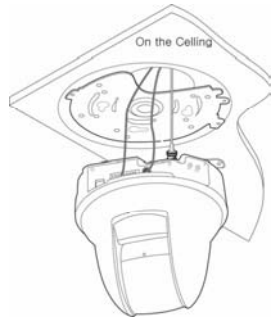

4. Assemble the camera, which should already have been attached to the product installation bracket, to the ceiling attachment installation bracket, facing forwards, and fix the camera with the supplied fixing screw.



5. To complete installation, rotate the installation cover along the groove of the ceiling attachment installation bracket, and fix it.



3.2.5. Installing the SNP-1000A Wall Mount

1. Prepare the accessories in the camera box (power adapter, audio extension cable, 2 installation brackets, 1 loose-proof screw, installation CD, installation cover) and the wall mount(STB-280PW or STB-230PW) and 3 installation bracket fixing screws in the mount packaging box.

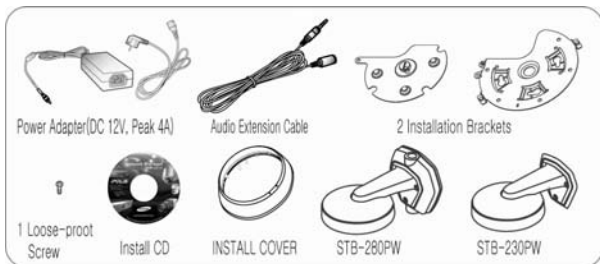

2. Fix the wall mount (STB-280PW) with 3 screws to the wall where the camera is to be installed, as shown in the figure on the right.



Caution

Precautions before Attaching the Installation Template

- Precautions before Attaching the Installation Template
- Installation Place: Check that the function and performance of the camera installed on the wall will not be adversely affected by the external environment, and that the ceiling can adequately support the weight of the camera.
- Installation Direction: Determine the main direction of the camera in advance and attach

the template so that the front of the template is in line with the camera direction.

- Caution: Since there is a danger of the product falling during installation, take care not to allow anyone to stand below the installation area.

3. Fix the wall bracket and the wall surface attachment installation bracket onto the wall mount (STB-280PW) with the screws supplied, as shown in the figure on the right, and connect the external incoming cables (video cable, network cable and power cord) to the camera.

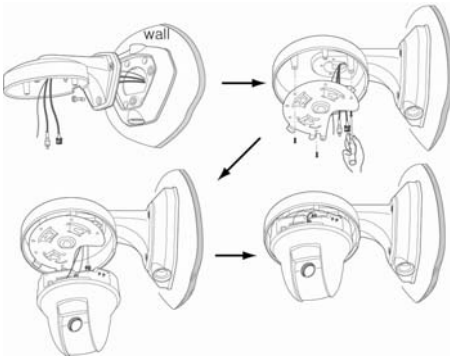

4. Assemble the camera, which should already have been attached to the product installation bracket, to the wall attachment installation bracket, facing forwards, and fix the camera with the supplied fixing screw.

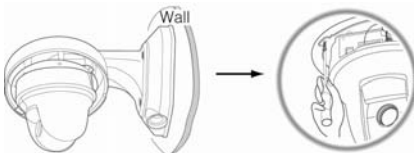

5. To complete installation, rotate the installation cover along the groove of the ceiling attachment bracket, and fix it.

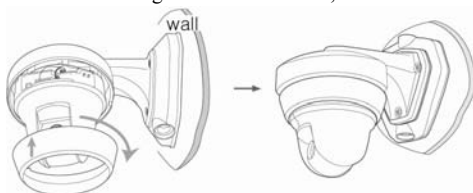

3.2.6. Installing the Dome Housing (STH-1000PI)

To install the Dome Housing (STH-1000PI), fix it instead of installing the cover in the last step “3.2.4. Installing the SNP-1000A on a Ceiling” on page 27 and “3.2.5. Installing the SNP-1000A Wall Mount” on page 29.

- When the Dome Housing is installed on the ceiling
- When the Dome Housing is installed on the wall

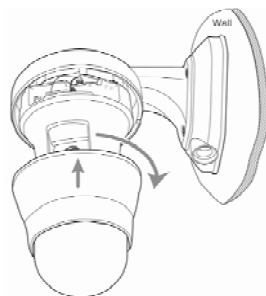

3.3. Network configuration and connection method

3.3.1. Configuration/connection using Web page

Use when there is one 10X PTZ Network Camera SNP-1000A to be installed.

1. Please connect user's PC to 10X PTZ Network Camera SNP-1000A using cross cable.

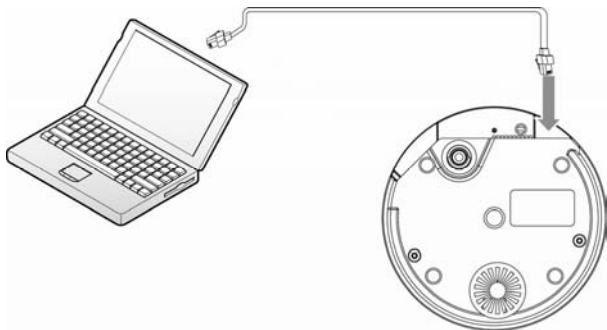

2. To configure network, the internal IP must be registered in the user's PC.



3. After pressing internet protocol (TCP/IP) properties, press the 'advanced' button to go into advanced configurations.



4. The IP address of IP setting tap can be added as "192.168.1.XXX"
"XXX" is an IP address voluntarily set by a customer.
5. Please launch a Web browser on user's PC and enter [192.168.1.100] in the URL address field and push <Enter> button. Connect to Webviewer login window of 10X PTZ Network Camera SNP-1000A.

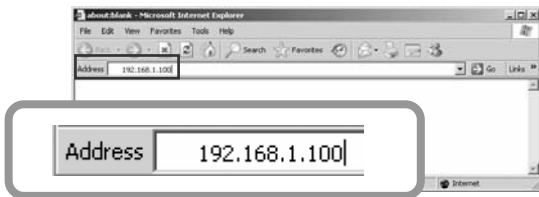

6. Please login with administrator's authorization and move to 'Setup-Network' page.

**Note**

Default value is ID : admin, PW : 11111111

- Please configure according to the network environment where 10X PTZ Network Camera SNP-1000A will be installed and push <Save> button to save the configuration.

iPOLiS

Network Setup

Network Configuration

LAN

IP Address: 192.168.1.251

NetMask: 255.255.255.0

Gateway: 192.168.1.1

DNS1: 168.126.63.1

DNS2: 168.126.63.2

xDSL

User Name: []

Password: []

DHCP

Port/DNS Configuration

Connection Port: 4000 (default: 4000)

HTTP Port: 80 (default: 80)

FTP Port: 21 (default: 21)

Use DDNS: Enable Disable

Save Cancel

① LAN / xDSL/ DHCP Configuration

<input checked="" type="radio"/> LAN	+ IP Address	192 . 168 . 1 . 120
	+ NetMask	255 . 255 . 255 . 0
	+ Gateway	192 . 168 . 1 . 1
	+ DNS1	168 . 126 . 63 . 1
	+ DNS2	168 . 126 . 63 . 2
<input type="radio"/> xDSL	+ User Name	<input type="text"/>
	+ Password	<input type="text"/>
<input type="radio"/> DHCP		

Item	Description
LAN Use	When network product is connected to normal local LAN or when connected to static IP, the network data to be allotted to the IP is configured.
xDSL	When using xDSL dynamic IP, enter the ID and PW.
Video Quality	When automatically receiving IP through DHCP server, the DHCP functions are activated. 'DHCP' is used in the LAN environment where the DHCP is activated. Generally, for mid/large scale, DHCP servers are operated through LAN and for small-scales, IP sharers use DHCP functions.

② Port Configuration

<input type="checkbox"/> Port/DDNS Configuration	
+ Connection Port	4000 (default: 4000)
+ HTTP Port	80 (default: 80)
+ FTP Port	21 (default: 21)
+ Use SWR	<input type="radio"/> Enable <input checked="" type="radio"/> Disable

Item	Description
Port Setting	The connection port and http, ftp port configurations can be set here and the DDNS use can be checked.



Note

Use SWR changes its IP address every time the user attempts to connect to the ISP and when the product is connected to a cable modem or xDSL modem. In this case, the user cannot know the changed IP address. When a product that uses dynamic IP is registered on the DDNS server, when wishing to connect to the product, the changed IP address can be easily recognized. In order to register the IP address to the DDNS server, set Use SWR as Enabled.

Ch4. How to Use Web Viewer

4.1. How to Use Web Viewer

4.1.1. Login

To connect to the login page, click the 'move to Webpage' button on Network Manager or enter network camera IP address on the internet web browser and press the enter key.



Enter user ID and password and push <Login> button, it then moves to the appropriate Web page.

**Note**

Default value is ID: admin, PW: 11111111

If you click <Guest> button, it moves to WebViewer page under the Guest authenticated status. However, administrator has to permit guest access for this.

**Note**

If you logged in first in administrator mode, please change the password of administrator. It can prevent other users from connecting to the administration page.

4.1.2. Web Viewer screen

Web Viewer screen is composed of menu area for camera/video configuration and screen area for displaying input video from camera.



■ Controls



Flip Image

Vertical reversal of channel screen





Stretch Image

When selecting resolution with Half D1 and CIF, stretches channel screen to resolution D1 size.



Save Image

Saves channel screen to 'JPEG file'.



Quad

Converts to 4 split screens (applied only to 4 channel server).

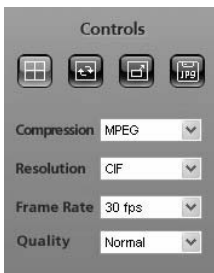

Compression

Video compression mode (the mode of compressing video)

- MPEG, JPEG

Resolution

Video resolution (the size of video screen transmitted)

- NTSC : D1(704x480), Half D1(704x240), CIF(352x240)
 - PAL : D1(704x576), Half D1(704x288), CIF(352x288)

Frame Rate

The number of maximum video frame transmitted for each second.

- 1, 5, 10, 15, 20, 25, 30

Quality

Quality Configures video quality

- Very High, High, Normal, Low, Very Low

**Pause**

Stops video for a while.

**OSD**

Displays related information.



Displays the title



Removes the title



Deinterlace

On/off function of Deinterlace.



Screen where
Deinterlace is not
applied



Screen where
Deinterlace is not
applied



Note

Deinterlace is a function to adjust the video quality softly by eliminating the border line which was made by an interlace function. The interlace function draws an even line and an odd line of the Image one after the other.



Camera Setup

Displays OSD control button of camera.



Camera OSD control button is displayed



Camera OSD is displayed



Day&Night

Day&Night configuration function
(Color, B/W configuration)



PTZ Control

PTZ control function



Screen where camera PTZ control window is displayed

**Note**

- The left/right slide bar can control focus (left slide bar) / zoom (right slide bar)
- The “+” displayed in the middle can be pressed using the mouse as the base point of the Pan / Tilt and it will Pan /Tilt according to that point.

Instruction for Camera OSD control button

**<↑>, <↓> button**

Moves selection displaying arrows up and down on camera OSD menu.

<←>, <→> button

Changes configuration of selected field on camera OSD menu.

<Set> button

Displays camera OSD or moves to upper/lower menu of selected field.

<Exit> button

Terminates camera OSD.

- ※ For configuring the function and detail operating method of 10X PTZ Network Camera SNP-1000A, refer 'Ch5. How to Operate Camera'.

4.1.3. Area Zoom guide

Area Zoom function supports easy and fast PTZ (Pan/Tilt/Zoom) control for the selected image area on the monitor.



Screen image of menu popped up by clicking mouse right button

- Clicking mouse right button delivers menu of Area Zoom function.



Screen image of Area Zoom pointer appeared by Area Zoom selection

- Clicking Area Zoom menu delivers Area Zoom mode showing yellow colored Area Zoom pointer at the center of monitor.



Screen image of new PTZ position moved by one time click.

- Clicking mouse left button only controls PTZ position at Area Zoom mode.



Screen image of selected image area in the mouse dragged square

- Clicking mouse left button and dragging a square shapes selected image area on the monitor.



Screen image of expanded area

- Releasing mouse left button stimulates automatic PTZ function mode at the selected image area.
- At automatic PTZ function mode, Area Zoom pointer is enlarged and PTZ function execution is not available.



Screen image of selected Move PTZ on menu

- At the Move PTZ zone of menu popped up by clicking mouse right button, reset function to 1x zoom, previous PTZ position, next PTZ position is available.
- PTZ operation at Area Zoom mode stores five positions of before and after the position change and deactivates Move PTZ zone of menu popped up by clicking mouse right button.

Storage item	Function
Go to 1x Zoom	Move to 1x Zoom from present PTZ position
Previous PTZ	Move to previous PTZ position
Forward PTZ	Move to next PTZ position

4.2. Using Administration page

4.2.1. Initialization Screen after Connecting

When connection is successful, the below screen will be displayed.

The screenshot displays the iPOLiS administration interface. On the left is a vertical navigation menu with icons and labels for: Live, Basic, Network, User, Pan/Tilt/Zoom, Motion Detection, Alarm/Sensor, Time, Log, Upgrade, System Reboot, and Log Out. The main content area is divided into two sections:

Video/Audio Setup

- Compression Type: MPEG JPEG
- Video Size: NTSC PAL
- Video Quality:
- Video Frame Rate:
- Video Channel: Channel 1
- Audio-In Channel: Channel 1
- Audio-Out Channel: Use
- Max User Count:
- Mic. Sensitivity: High Low

Product Information

- Model:
- Mac Address:
- Camera Name: (English Only)
- Location: (English Only)
- Description: (English Only)
- Memo: (English Only)

At the bottom of the form are two buttons: **Save** and **Cancel**.

4.2.2. Live

Please Move to Web Viewer page



[Web Viewer live screen]

4.2.3. Basic

Configures basic information for camera.

The screenshot shows the iPOLiS administration interface. On the left is a navigation menu with icons and labels for: Live, Basic, Network, User, Pan/Tilt/Zoom, Motion Detection, Alarm/Sensor, Time, Log, Upgrade, System Reboot, and Log Out. The main content area is divided into two sections:

- Video/Audio Setup:** Contains several expandable settings:
 - Compression Type: Radio buttons for MPEG and JPEG.
 - Video Size: Radio buttons for NTSC and PAL, and a dropdown for CIF.
 - Video Quality: A dropdown menu set to Middle.
 - Video Frame Rate: A dropdown menu set to 30fps.
 - Video Channel: A checked checkbox for Channel 1.
 - Audio-In Channel: A checked checkbox for Channel 1.
 - Audio-Out Channel: A checked checkbox for Use.
 - Max User Count: A dropdown menu set to 10.
 - Mic. Sensitivity: Radio buttons for High and Low.
- Product Information:** Contains several expandable settings:
 - Model: Text input field containing SNP-1000.
 - Mac Address: Text input field containing 00-09-18-00-2F-5a.
 - Camera Name: Text input field containing SNP-1000, with a note "(English Only)".
 - Location: Text input field containing Location, with a note "(English Only)".
 - Description: Text input field containing Description, with a note "(English Only)".
 - Memo: Text input field containing Memo, with a note "(English Only)".

At the bottom of the Product Information section are "Save" and "Cancel" buttons.

Video/Audio Setup

Item	Description
Compression	Video compression mode (Compression mode of video in the camera)
Video Size	If the type of installed camera (NTSC/PAL) is selected, then the size of screen on the camera becomes selectable.
Video Quality	Selects the quality of video screen. In case of low speed internet, lower the video quality to see seamless video.
Video FrameRate	Configures the number of transmitted frame per second in the camera.

Item	Description
Video Channel	Selects the video channel to be used in the camera.
Audio-In Channel	Selects whether to use the audio input channel in the camera or not.
Audio-Out Channel	Selects whether to use the audio output in the camera or not.
Max User Count	Configures the number of users who can be connected to the camera through the network(1~20 persons)
Mic. Sensitivity	Audio amplifying function onfigures Low for the microphone which has amplifying function and High for the microphone which has no amplifying function. (In case of Line-In signal, configure Low)

Product Information

Item	Description
Model	Displays model name of the camera.
Mac Address	Displays MAC Address of the camera.
Camera Name	onfigures name of the camera, it help to classify several cameras.
Location	The location of the installed camera can be entered.
Description	Additional description related to the camera can be entered.
Memo	The contact of camera administrator can be entered.

4.2.4. Network

Configures network information of the camera.

Network Configuration

According to the user's network environment, it is classified into LAN, xDSL, DHCP.

Item	Description
LAN	In case the camera is connected to the local network or xDSL with a static IP address, configure network information to be assigned to the camera.
xDSL	In case of xDSL with a dynamic IP address, enter password in UserName and Password field.
DHCP	This case is selected in case of using IP sharing box/ cable modem.

Port/DDNS Configuration

Item	Description
Connection Port	This controls communication with camera. (Default : 4000)
HTTP Port/ FTP Port	This helps to connect to web page or FTP server. (Default : http=80, ftp=21)
Use SWR	Select if use of SWR function is available. The way of connection which used ID does not support.
Use DDNS	Select if DDNS server is available. DDNS server is connected to server without reference to changed IP because there is possibility that floating IP constantly is changed.

※ A detailed explanation about DDNS usage refers to <Appendix A. DDNS Usage>.

4.2.5. User

This describes password change for administrator or user registration.

iPOLiS User Setup

Administrator Password Change

• Type

• Re-Type

Guest Setup

• Guest Access Permission

Current Users

User Name	Password	Control Level	Use
aaaaaaa	*****	<input checked="" type="checkbox"/> Video <input checked="" type="checkbox"/> Controls <input checked="" type="checkbox"/> Audio-In	<input checked="" type="checkbox"/>
bbbbbbb	*****	<input checked="" type="checkbox"/> Video <input checked="" type="checkbox"/> Controls <input checked="" type="checkbox"/> Audio-In	<input checked="" type="checkbox"/>
ccccccc	*****	<input checked="" type="checkbox"/> Video <input checked="" type="checkbox"/> Controls <input checked="" type="checkbox"/> Audio-In	<input checked="" type="checkbox"/>
ddddd	*****	<input checked="" type="checkbox"/> Video <input checked="" type="checkbox"/> Controls <input checked="" type="checkbox"/> Audio-In	<input checked="" type="checkbox"/>
eeeeeee	*****	<input checked="" type="checkbox"/> Video <input checked="" type="checkbox"/> Controls <input checked="" type="checkbox"/> Audio-In	<input checked="" type="checkbox"/>

Controls = Pan / Tilt / Camera / Audio-Out / Alarm-Out

Item	Description
Administrator Password Change	Change password of administrator
Guest Setup	User clicks 'Guest' button to decide whether allowing guest to connect Main Viewer.
Current User	You can register new user or delete, and set up user's authority.

※ Set up user authority

User's authorities set up at 'Current User' are as follows.

Item	Description
Video	Use video related setup function (Compression, Resolution, Framerate, Quality)
Control	Pan, Tilt, Zoom, Audio output, Alarm output
Audio	Audio Input
USE	Whether relevant account is used (If not checked, not allowed log-in)

- **Example 1)** In case control function is limited (Do not check Controls box)



- ※ Pan, tilt, zoom, audio output, alarm output function icon is inactivated

- **Example 2)** In case video function is limited (Do not check Video)



- ※ Compression, Resolution, Framerate, Quality set up icon is inactivated.

4.2.6. Pan/Tilt/Zoom

Configures PTZ Swing and Preset of the camera.

iPOLiS Pan/Tilt/Zoom Setup

PTZ Camera Configuration

Channel: CH1

PTZ Display: On Off

OSD Display: On Off

Preset: [] Move Set Delete Delete All

Swing: Pan Swing Tilt Swing Stop

Group: [] Run Stop

Swing Setup

First Preset: [] Second Preset: []

Mode: Pan Swing Speed: 64 Duration: 3

Save Cancel

Group Setup

Group No.: 1

Preset No.: 1

Travel Speed: 64

Dwell Time: 3

Add Set Clear

Item		Description
PTZ Camera Configura tion	Channel	Select the channel of camera.
	PTZ Display	Display PTZ menu.
	OSD Display	Display OSD.
	Preset	Set or delete(delete, delete all) the Preset. Screen move the position of Preset.
	Swing	Surveille Pan/Tilt Swing at the position of preset, set up the swing menu.
	Group	Surveille repeatedly at the position of preset, set up the Group menu.
Swing Setup	First Setup	Indicate the first position of surveillant Preset
	Second Setup	Indicate the second position of surveillant Preset
	Mode	Select Pan/Tilt Mode.
	Speed	Set Swing speed between Presets.
	Duration	Set interval time on Preset.
Group Setup	Group No.	Set Group Number among 1~6
	Preset No.	Set Preset included the Group.
	Travel Speed	Set swing Speed between preset.
	Dwell Time	Set interval time on Preset.

4.2.7. Motion Detection

This sets up motion detection function of camera.

Item	Description
Grid Display	Basic grid, used to choose area on the screen, is displayed or hidden.
Select Area	When selecting motion detection area, click <Select All> button to select all areas, or click <Deselect> button to cancel the selected area.
MD Enable	Decide whether you use motion detection function.
MD Sensitivity	Setting up sensitivity to detect motion to adjust input video by situation. You can select 1-5, and 5 is the highest.

4.2.8. Alarm/Sensor

This sets up necessary information when using alarm function by attaching sensor to camera.

iPOLiS

- Live
- Basic
- Network
- User
- Pan/Tilt/Zoom
- Motion Detection
- Alarm/Sensor**
- Time
- Log
- Upgrade
- System Reboot
- Log Out

Alarm/Sensor Setup

Digital In(Sensor) Setup

+ Sensor No. Sensor1 Sensor2

+ Sensor Type Normal Open Normal Open

Digital Out(Alarm) Setup

	Sensor1	Sensor2	MO
R1	<input type="checkbox"/>	<input type="checkbox"/>	<input type="checkbox"/>
Duration	30 sec		
Goto Preset	N/A	N/A	
	0	0	
FTP	<input type="checkbox"/>	<input type="checkbox"/>	<input type="checkbox"/>
E-Mail	<input type="checkbox"/>	<input type="checkbox"/>	<input type="checkbox"/>

FTP/E-mail Setup

FTP Setup

+ FTP Server Name

+ Home Directory

+ User ID

+ User Password

E-Mail Setup

+ Recipient E-mail Address 1

+ Recipient E-mail Address 2

+ SMTP Server Name

+ User ID

+ User Password

+ Mail Subject SNP-1000Message (English Only)

+ Mail Body SNP-1000Event!!! (English Only)

Alarm/Sensor Setup

◇ Digital In Setup

Item	Description
Sensor Type	Types of sensors are 'Normal open' and 'Normal close.' This selects up type of connected sensor.

◇ Digital Out Setup

Item	Description
Alarm	Set up Alarm Out responding when event is recognized by connected sensor (Sensor 1) or Motion Detection (MD)
Duration	Set up time to operate relay. It means the period from the time when sensor detects event to the time when relay is released.
FTP	In case event occurs by sensor (Sensor 1) or Motion Detection (MD) on the screen, decide whether transferring related information to FTP.
E-mail	In case event occurs by sensor (Sensor 1) or Motion Detection (MD) on the screen, decide whether transferring related information by e-mail.

E-mail/FTP Setup

Set up FTP server and e-mail information to which related information is transferred in case alarm occurs.

Item		Description
Mode		Select media for data transfer.
FTP	Server Name	Enter domain or IP address of FTP server.
	Home Directory	Set up home directory to save relevant data at FTP server.
	User ID	Enter ID to connect FTP server.
	User Password	Enter PW to connect FTP server.

Item		Description
E-mail	Recipient E-mail Address 1 Recipient E-mail Address 2	You can designate up to two e-mail address receiving data when alarm occurs.
	Server Name	In case you use outside e-mail server, enter the name of the outside e-mail server.
	ID	Enter ID to connect the outside e-mail server.
	Password	Enter PW to connect the outside e-mail server.
	Mail Subject	Enter the subject of mail to be transferred.
	Mail Body	Enter the body of mail to be transferred.

**Note**

If motion is detected, the contents transferred by e-mail or to FTP are varied according to the set-up of 'Video Compression' at Admin page (Basic).

- MPEG : Video length is set by 'Duration' of 'Digital Out Setup'.
File extension is 'ste', you can play this by 'SLiM Player'.
- JPEG : JPG type image file attached.

4.2.9. Time

Current Time

Item	Description
Date	Current setup date displayed
Time	Current setup time displayed

Time Setup

Item	Description
Set Manually	Adjust time manually.
Time Server	Set up address of time server for Server 1 - 5.

4.2.10. LOG

Recent activities made for camera are displayed as log.

iPOLiS Log View Setup

Lines: View (Total Current Log : 247 Lines) Clear

```

[2007/02/19 11:05:58] User Connection : Admin Login OK
[2007/02/19 11:05:58] User Connected IP = 192.168.1.68
[2007/02/19 08:03:42] User Connection : Admin Login OK
[2007/02/19 08:03:42] User Connected IP = 192.168.1.68
[2007/02/19 07:50:30] User Connection : Admin Login OK
[2007/02/19 07:50:30] User Connected IP = 192.168.1.68
[2007/02/19 07:48:55] User Connection : Admin Login OK
[2007/02/19 07:48:55] User Connected IP = 192.168.1.68
[2007/02/19 07:42:29] User Connection : Admin Login OK
[2007/02/19 07:42:29] User Connected IP = 192.168.1.68
[2007/02/19 06:56:24] User Connection : Admin Login OK
[2007/02/19 06:56:24] User Connected IP = 192.168.1.68
[2007/02/19 06:45:49] User Connection : Admin Login OK
[2007/02/19 06:45:49] User Connected IP = 192.168.1.68
[2007/02/19 06:15:41] Guest Login OK...
[2007/02/19 06:15:39] User Connected IP = 192.168.1.169
[2007/02/19 06:13:40] Guest Login OK...
[2007/02/19 06:13:31] User Connected IP = 192.168.1.169
[2007/02/19 05:43:15] Guest Login OK...
[2007/02/19 05:43:15] User Connected IP = 192.168.1.44
  
```

Send Log to Administrator E-mail per Day (at 04:00)

Item	Description
Lines	Set up number of lines of the list.
View	Log is viewed with number of lines you set up most recently.
Clear	Delete logs.

4.2.11. Upgrade

Upgrade program of 10X PTZ Network Camera SNP-1000A.

The screenshot shows the iPOLiS administration interface. On the left is a navigation menu with options: Live, Basic, Network, User, Pan/Tilt/Zoom, Motion Detection, Alarm/Sensor, Time, Log, Upgrade, System Reboot, and Log Out. The main content area is titled 'System Upgrade Configuration' and contains two sections:

- System Upgrade Configuration:** This section has three rows:
 - Firmware/Web: A text input field followed by a '찾아보기...' (Find) button and a 'Send' button.
 - Firmware Version: 0.2.3
 - WebPage Version: 0.2.3
- Factory Reset Setup:** This section has one row:
 - Factory Mode: A 'Reset' button.

System Upgrade Configuration.

Item	Description
Firmware/Web	Upgrade firmware and Web-page of 10X PTZ Network Camera SNP-1000A.

Factory Mode Setup

If you click <Reset> button, server is returned to initial value when shipped from the factory after confirmation procedure by administrator.

4.2.12. System Reboot

System is rebooted after confirmation procedure of administrator.

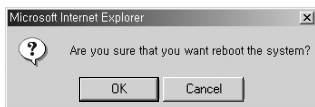

Click <OK> button to reboot System.

Ch5. How to Operate Camera

5.1. OSD Menu Organization

PTZ camera can be set up on the OSD (On Screen Display) menu displayed on the video monitor.

① Camera Setting

P1	P2	P3	P4	Defaults
	①Focus	①Focus Mode	Auto/Manual/ One Shot AF	OneShot AF
		②Zoom Tracking	Mode: On/Off	ON
			Speed: Slow/Fast	Fast
	③Digital Zoom	Off(2X~10X)	OFF	
	②White Balance	AWB Mode	ATW/AWC/MANUAL	ATW(O)
			▶ATW -ATW(I): Indoor -ATW(O): Outdoor ▶Manual -Red -Blue	29 41
	③Exposure	①Brightness	25	025
			②Iris	Auto
		③Shutter	Manual: Iris Level	100
			---	ESC
A.FLK				
④Sens-Up	Manual: 1/60~1/120,000, x2~x128	1/60		
	④Sens-Up	Auto: Sens-Up Limit x1~x128	X4	
		Off		
④Back Light	High/Middle/Low/Off		OFF	
⑤AGC	High/Normal/Off		Normal	
⑥SSNR	High/Middle/Low/Off		Low	
⑦Day Night	&	Auto		
		B/W		
		Color	Burst Level	060
⑧Others		①Sync		Internal
		②Image Adj.	Sharpness	008
			Color	050
③Freeze	On/Off	OFF		

② Sequence Setting

P1	P2	P3	P4	Defaults
	①Preset	①Setting ②Edit ③Execute ④Clear ⑤Status		
	②Swing SEQ	①Pan Swing	①Setting ②Execute ③Clear	
		②Tilt Swing	①Setting ②Execute ③Clear	
		③P&T Swing	①Setting ②Execute ③Clear	
	③Group SEQ	①Group1	①Setting ②Execute ③Clear	
		②Group2	①Setting ②Execute ③Clear	
		③Group3	①Setting ②Execute ③Clear	
		④Group4	①Setting ②Execute ③Clear	
		⑤Group5	①Setting ②Execute ③Clear	
		⑥Group6	①Setting ②Execute ③Clear	
	④Tour SEQ	①Setting ②Execute ③Clear		
	⑤PTZ Trace	①Trace1	①Replay ②Memorize	
		②Trace2	①Replay ②Memorize	
		③Trace3	①Replay ②Memorize	
		④Trace4	①Replay ②Memorize	
	⑥Auto Run	①Mode	①Off	OFF
			②Preset: Preset No	
			③Swing: Swing Mode Pan/Tilt/P&T	
			④Group: Group No	
			⑤Tour	
			⑥Trace: Trace1~Trace4	
			⑦A.Pan - ①Auto Pan Speed: 20~50 - ②Tilt Angle: 10~45	32 25
	②Time	5,10,20,30(Sec), 1,2(Min)	30sec	
	⑦Power On Resume	On/Off		OFF

③ P/T Setting

P1	P2	P3	P4	Defaults
	①Pan Limit	①Position ②ON/OFF		
	②Tilt Limit	①Position ②ON/OFF		
	③Area Setting	①Area1	①Area Name ②Position ③ON/OFF	
		②Area2		
		③Area3		
		④Area4		
	④Area Masking	①Mask1	①Position ②ON/OFF	
		②Mask2		
		③Mask3		
		④Mask4		
	⑤Prop.P/T	ON/OFF		ON
	⑥Digital Flip	ON/OFF		ON
	⑦Jog Speed	Manual(10,20,30,40,50,60)		Manual

④ OSD Setting

P1	P2	P3	P4	Defaults
	① Camera Name	① ON/OFF ② Edit	① Position	
	② Preset Number	ON/OFF	② ON/OFF	ON
	③ Preset Name	① ON/OFF ② Edit		
	④ Sequence Status	ON/OFF		ON
	⑤ Area Name	ON/OFF		OFF
	⑥ PTZ Position	ON/OFF		OFF
	⑦ Language	English, 中文, Francais, Deutsch, Espanol, Italiano		English

⑤ Initialize

P1	P2	P3	P4	Defaults
	① Power On Reset	① Cancel ② Execute		
	② Initial Position	① Position ② ON/OFF		
	③ Factory Default Set	① Cancel ② Execute		
	④ Camera Default Set	① Cancel ② Execute		
	⑤ Auto Refresh	OFF, 1~7Days		OFF

⑥ Status

P1	P2	P3	P4	Defaults



Note

Preset setting is only possible within the OSD menu.



Note

Symbol Description

- When there are sub menus under the selected OSD menu.
Numbers are displayed in white color like ① on the right top of the screen.
- When there is no sub menu under the selected OSD menu.
Numbers are displayed in black color like ❶ on the right top of the screen.

5.2. PTZ Camera User Menu Settings

Execution of OSD Menu : After checking if the camera is in manual operation mode, press the OSD Menu key. The following commands are displayed on the monitor screen.

Main Menu

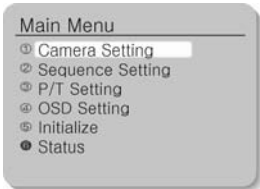

The selection key moves up and down. Press the execution key switch on the selected menu to change the setup menu. Press the ESC key to exit the OSD Menu.

5.2.1. Camera Setting

Select the Camera Setting on the Main Menu screen to control camera settings

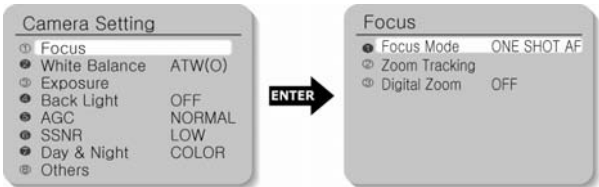

5.2.2. FOCUS

In Focus menu, you can set up the focus mode among Auto, Manual or One Shot AF.

① Focus Mode

- Auto : The camera adjusts the focus automatically while monitoring the screen continuously in the auto mode. In the auto focusing mode, zoom key operation is not recognized as the input of the focus key.
- Manual : In the manual mode, users can adjust the camera focus manually.
- One Shot AF : Only when the camera does not move, it turns into the auto mode. It is the same as the manual mode.

② Zoom Tracking

- Mode: When you select ON, the Focus function is executed when the Zoom function is on. When you select OFF, the Focus function is not executed even when the Zoom function is on.
- Speed: Fast will speed up the Zoom. Slow will slow down the Zoom.

③ Digital Zoom

Magnification of the Digital Zoom can be selected among Off, 2X~10X.

- ※ It is recommended that the Digital Zoom should be set up before the preset operation.



Caution

- Digital Zoom

As the digital zoom magnification increases, the image quality is lowered.

- Auto-focus

Auto-focus may not function normally under the following conditions.

- When the light level in the surveillance area is low
 - When the slow-shutter works
 - When the amplification is increased
 - When the light level in the surveillance area is excessively high
-

- When the objects in the long and short distance are under the same surveillance area
- When there is no contrast (white and black) in the object (e.g. sky or wall)
- When the thin horizontal line is captured

5.2.3. White Balance

The White Balance function corrects the abnormal white colour into the normal white colour under any colour temperature lighting.

Select the mode among ATW, AWC and Manual. ATW is selected by default.

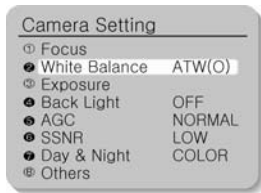

■ WB Mode

▪ ATW

Balances the colour automatically depending on the source of light from 1,800~10,500K colour temperature.

- Indoor[ATW(I)] : Use this mode in the area under the limited colour temperature.
- Outdoor[ATW(O)] : Use this mode in the area under the broad colour temperature.

- **AWC:**

Set up the lighting to the objects and corrects the right colour temperature to that of a white object. Camera works under the setup conditions. For the most appropriate condition under the current illumination, capture the white paper and then change the mode into AWC. Press the Enter key and then AWC Start will be displayed. When the adjustment is completed after pressing the Enter key for AWC Start, go to the upper menu. When conditions change, adjust the white balance function again.

- **Manual**

Fine tuning is possible through this manual control mode. Select the colour temperature and increase or decrease the Red or Blue values to shift the colour of the object.

- Red : Red Gain can be changed.
- Blue : Blue Gain can be changed.



Note

White Balance may not function properly under the following conditions.

- When the colour temperature surrounding the object is very high. (e.g. clear sky, sunset)
 - When it is dark around the object.
 - When the camera is pointing towards a fluorescent lamp directly or when lighting conditions change a lot.
-

5.2.4. Exposure

Camera exposure can be controlled.

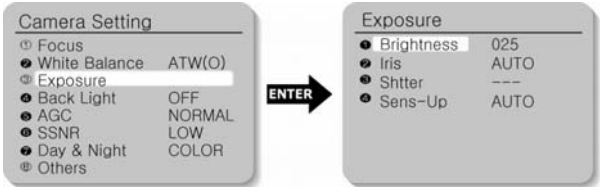

① Brightness

The brightness of the screen can be adjusted.

② Iris

Auto mode or manual mode can be selected.

- Auto: The brightness of the image signal can be adjusted automatically depending on the amount of light.
- Manual: The brightness of the image can be adjusted.

③ Shutter

- ---: Electronic shutter mode is enabled. The shutter speed is controlled automatically according to the brightness of the screen.
- A.FLK: Use this mode when the screen flickers because of inconsistent frequency with the surrounding lights.
- Manual
 - Shutter speed can be controlled manually.
 - Shutter speed can be adjusted from 1/60(1/50) second to 1/120,000 second.
 - Sens-Up function can be operated manually from x2 ~ x128.



Note

- If the Shutter mode is ESC in the inner synchronization mode and the camera faces to the bright fluorescent lamp directly, the image may be unstable. Be careful to select the installation location.

- If the Manual or A.FLK mode is selected for the Shutter menu, the Sens-Up function is disabled.

4 Sens-Up

- Auto: The low light level of the night or dark condition is detected automatically and the bright and clear image can be maintained.
 - Sens-Up Limit: Maximum accumulated magnification can be selected.
- Off: Sens-Up function is cancelled.



Note

As the accumulated magnification increases, the screen goes bright. But, the after image of the moving object also becomes larger and the optimum Auto Focus function may not work.

5.2.5. Back Light

Unlike other cameras, Samsung Techwin's unique W-III DSP chip gives you a clear image of the subject even with bright backlight.

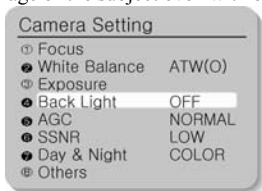

- HIGH : Gain increased from 6dB up to 34dB.
- MIDDLE : Gain increased from 6dB up to 30dB.
- LOW : Gain increased from 6dB up to 18dB
- OFF : BLC function is cancelled.

5.2.6. AGC

When the brightness of the image taken under dark light is under a certain level, the AGC (Automatic Gain Control) functions to define whether to control the Gain automatically or not.

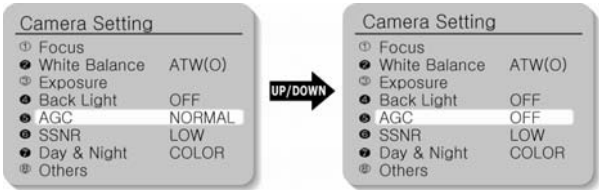

- HIGH : Gain increased from 6dB up to 34dB.
- NORMAL : Gain increased from 6dB up to 18dB.
- OFF : Gain is fixed at 6dB.

5.2.7. SSNR (Samsung Super Noise Reduction)

SSNR function reduces background noise under low light conditions differently in different modes. The noise reduction effect grows in Off, Low, Middle and High modes in order.

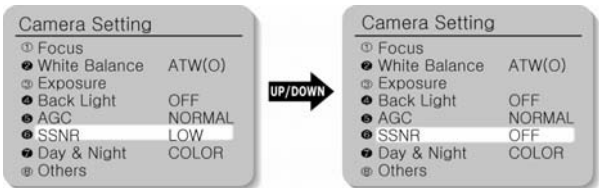

- OFF : No noise reduction effect.
- LOW : Noise reduction effect is small but there is little afterimage.
- MIDDLE: Noise reduction effect is generally effective in this mode. Noise can be reduced properly and the afterimage is not strong.

- HIGH : Noise reduction effect is excellent but afterimage is also strong.



Note

When you select the AGC mode as “OFF”, you cannot use the SSNR function.

5.2.8. Day & Night

The darkness level is detected automatically under low light conditions such as at night or under dark light to keep the screen bright and clear.

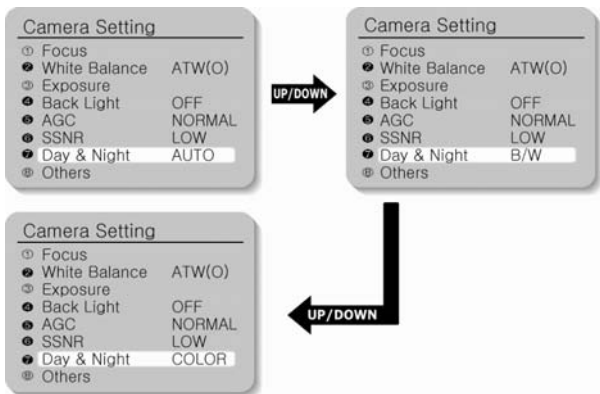

- COLOR : Output images are displayed in colour all the time. Burst signal size can be adjusted.
- B/W : Output images are displayed in black and white all the time. Burst signal can be kept or removed.

- AUTO : Under day condition, the mode is automatically changed into the COLOR mode to keep an optimum colour. At night, the mode is automatically changed into the B/W mode to distinguish dark images clearly.



Note

- If the AGC is in OFF mode, the Auto mode cannot be used. Only COLOUR or B/W mode can be used.
- If the sunlight or halogen lamp is used in B/W mode, the focus may be blurred compared with the general illumination.

5.2.9. Others



① Sync

Internal Sync is selected by default.

- Internal : Internal synchronization

② Image Adj.

Clarity of the video signal and saturation of the color may be adjusted.

- Sharpness : The overall sharpness of the image can be adjusted.
- Color : The overall colour density of the image can be adjusted.

③ Freeze

Moving image can be stopped and replayed.

- ON : Image can be frozen.
- OFF : Frozen image is released and the film is replayed.

5.3. Sequence Setting

Sequence Setting Menu

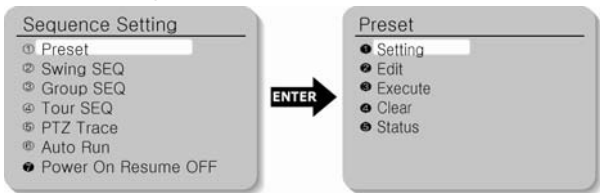

5.3.1 Preset

12 items such as Pan/Tilt location, Zoom and Focus are selected among camera functions and they can be called for monitoring. Total 128 points can be preset.

- **Setting** : Select the Preset number for setup. Adjust Pan/Tilt/Zoom and press the Enter key to save the setting. If you want to change the 12 items such as Focus, Brightness, Iris and Scene Adj., use the Up/Down key to go to and select the item. If you don't want to change the 12 items, press the ESC key to go to the next Preset step.
- **Edit** : You can edit the 12 preset items such as Pan/Tilt location, Zoom and Focus, which are selected among camera functions.
- **Execute** : Select the Preset number for execution.
- **Clear** : Select the Preset number to delete for clearing.
- **Status** : The current Preset number setup is displayed.

■ Preset Menu Setting

1. Select the Preset item on the Sequence Setting Menu
2. Select the Setting item.



3. Select the Preset number.
4. Set up the Zoom and Focus.

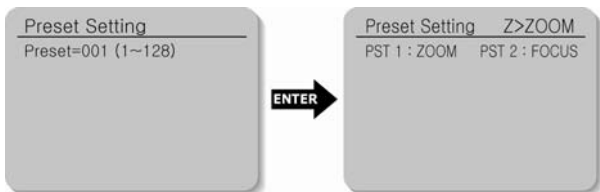

5. To change the camera settings, select Edit from the upper menu first. Select the item to change, and then make the necessary adjustments.

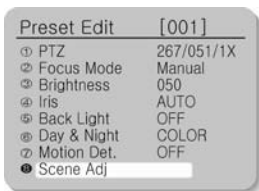

6. If you select the Scene Adj. item, such items as Shutter, AGC, SSNR, Sens-Up, White Balance can be set up differently in every Preset item.

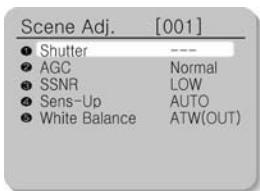
**Note**

In the White Balance setting of the individual Preset Scene Adj., the AWC selection is not available.

5.3.2. Swing SEQ

Swing surveillance can be executed and set up and the data can be deleted.

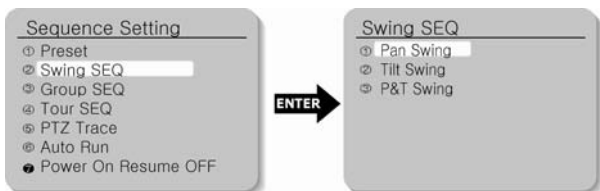

- Pan Swing : Swing surveillance for the Pan direction is executed and set up. Data is deleted.
- Tilt Swing : Swing surveillance for the Tilt direction is executed and set up. Data is deleted.
- P&T Swing : Swing surveillance both for the Pan and the Tilt directions are executed and set up simultaneously. Data is deleted.
 - Setting : The Preset Position for Swing function is selected by clicking the mouse and confirmed with the Execution key. SPD

is the moving speed (01-64step). DWL is the stop time (00-120sec). Press the Execution key in the location with selection mark to finish the setting process.

- Execute : Swing surveillance is executed. Stop key designates this function.
- Clear : Data in the Swing function is deleted.

5.3.3. Group SEQ

Group SEQ: Sequence surveillance can be executed and set up and data can be deleted. Up to 6 groups can be registered.

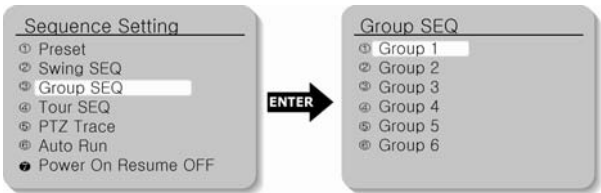

- Setting : Preset position for swing is selected by clicking the mouse and confirmed with the Execution key. SPD is the moving speed (01~64 step). DWL is the stop time (00~120sec). Press the Execution key in the location with selection mark to finish the setting process.
- Execute : Swing surveillance can be executed. Stop key will stop this function.
- Clear : Swing data can be deleted.

5.3.4. Tour SEQ

Group surveillance can be executed and set up and data can be deleted.

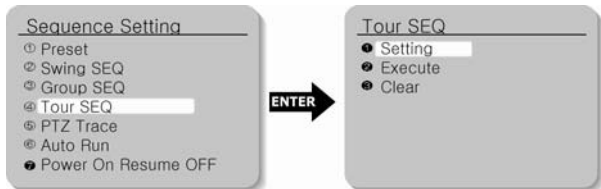

- **Setting** : The registered Group Sequence is selected by clicking the mouse and confirmed with the Execution key. If the selected number is not registered, it cannot be input. Press the Execution key in the location with selection mark to finish the setting process.
- **Execute** : Group surveillance is executed.
- **Clear** : Group surveillance data are deleted.

5.3.5. PTZ Trace

Maximum 4 patterns of the manual operation paths (for Pan, Tilt, Zoom and Focus) are memorized and replayed.



- **Replay** : The manual operation paths are repeated and replayed. Stop key will stop the replay.



Note

If the operation range is limited using ①Pan Limit and ②Tilt Limit, please note that other operations

- Memorize: Manual operations for minimum 120 seconds after executing this function are memorized into the internal memory. Nevertheless, the memorizing time becomes different depending on the PTZ operation. OVER mark will finish this function.

**Note**

If the operation range is limited using ①Pan Limit and ②Tilt Limit, only the operations within the limited range are memorized.

**Note**

Press the OSD key to stop the internal memory to continue saving.

5.3.6. Auto Run

If there is no controller operation by the user for a certain time, the sequence operation designated by the user will be executed.

- Mode:
 - OFF : Auto Run will be cancelled.
 - Preset : Auto Run in the corresponding Preset number
 - Swing : Auto Run in the corresponding Swing mode
 - Group : Auto Run in the corresponding Group number
 - Tour : Auto Run in the corresponding Tour number
 - Trace : Auto Run in the corresponding Trace number
 - A. Pan : 350° Auto Run in Pan direction
 - ※ Auto Pan Speed: Pan operation in the speed designated by the user.
 - ※ Tilt Angle: The tilt angle set up by the user is kept.

- Time : Auto Run operation is executed after a certain time designated by the user.(Time can be set up by the unit of 5, 10, 20, 30 sec and 1~5 min.)

5.3.7. Power On Resume

When the power supply for the camera is stopped for some reason, such as electricity failure, and resumed, the Sequence Settings before the power off are restored.

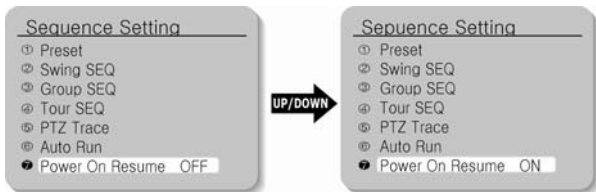

5.4. P/T Setting

5.4.1. Pan Limit

The moving range in the Pan direction can be limited.

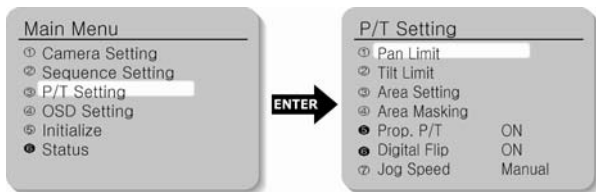

- **Position** : Moving range can be set up. Set the position from the left using the Execution key. The stop position may change due to the initialization by such operation as power resumption depending on position setting. This does not mean it is out of order.
- **On/Off** : When this function is on, the limit is effective. Default setting is Off.

5.4.2. Tilt Limit

Moving range in the tilt direction can be limited.

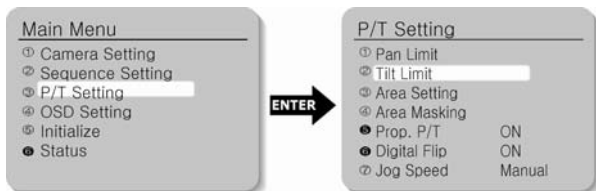

- **Position** : Moving range can be set up. Set the position from the top direction using the Execution key. The stop position may change due to initialization by such operation as power

resumption depending on position setting. This does not mean it is out of order.

- On/Off : The application of limitation will be determined. Default setting is Off.

5.4.3. Area Setting

Areas can be indicated. Areas can be designated up to 4.

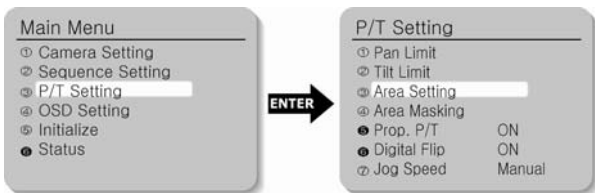

- Area Name : Area name can be set up. Use the Execution key to enter the area name. A maximum of 12 letters (English, Chinese, numbers) can be entered. When you finish inputting the name, adjust the position mark to "SET" and press the Execution key. This is the end of Area Name setting.
- Area Position : Area range can be designated. Use the Execution key to determine the position from the left. If the area range is overlapped, the smaller area number will indicate the overlapping part.
- On/Off : It can be determined whether or not to activate the area mark. The activation becomes effective as soon as the position moves from the current area to other areas. Set up the OSD Setting as ON. If it is in OFF mode, this function does not work. Default setting is OFF.

5.4.4. Area Masking

If you want to exclude some areas for surveillance, they can be turned into black. You can mask 4 parts of one screen.

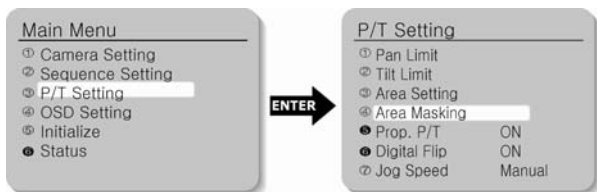

- Position : Use the Execution key to determine the position for screen operation from the left.
- On/Off : Operation of screen area masking can be determined. Default setting is OFF.



Note

If Area Masking is set while the Camera is in the Digital Flip position, automatically the Camera moves the initial position which is not set for the Digital Flip and then Area Masking position can be set. This is not a malfunction.

5.4.5. Prop. P/T

Pan and Tilt speeds can be changed depending on zoom magnification. Tele will slow down the speed of Pan/Tilt and Wide will increase the Pan/Tilt speed. It will take about 20 seconds for 1 cycle in Tele mode and about 3 seconds in the Wide mode. Default setting is ON. Default setting is OFF.

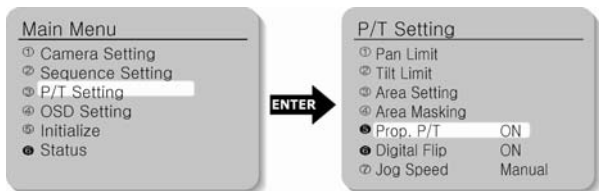

5.4.6. Digital Flip

When you operate the Tilt up to 100° limit and keep it for a certain time, the image gets reversed automatically and the opposite Tilt area is seen. When you want to monitor the moving object under the camera, execute the Digital Flip function. You can observe the moving object without reversing of the screen.

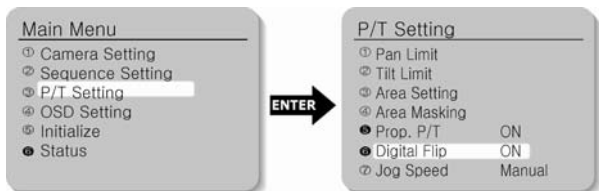

5.4.7. Jog Speed

Because using Pan/Tilt command protocol is fixed speed type, so that occasion that Pan/Tilt speed is slow, can adjust command rate by enter manual mode.

5.5. OSD Setting

5.5.1. Camera Name

Camera name is set up.

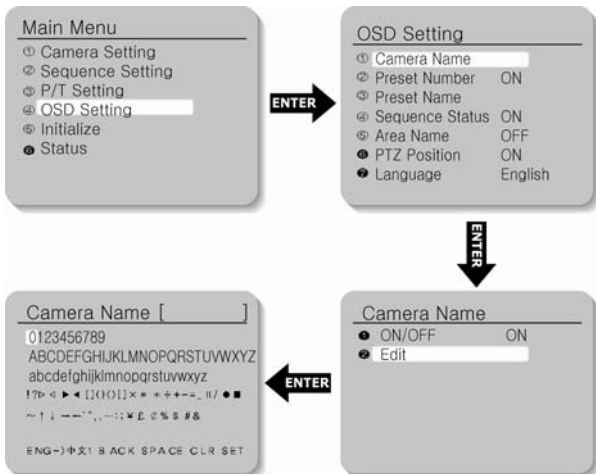

Note

If you want to edit the item, move the cursor. Then select the character.

- **Edit :** A maximum of 12 characters consisting of English (or Chinese, Japanese), numbers and special characters can be input for Camera Name.
- **On/Off :** The operation of this function is preset. Default setting is On.

5.5.2. Preset Number

Preset numbering is set up. (Default setting is ON.)

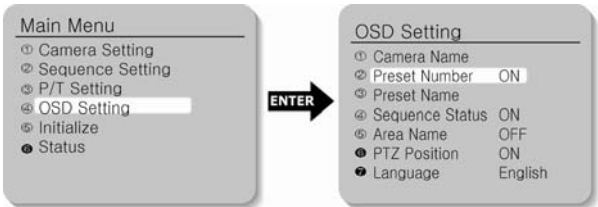

5.5.3. Preset Name

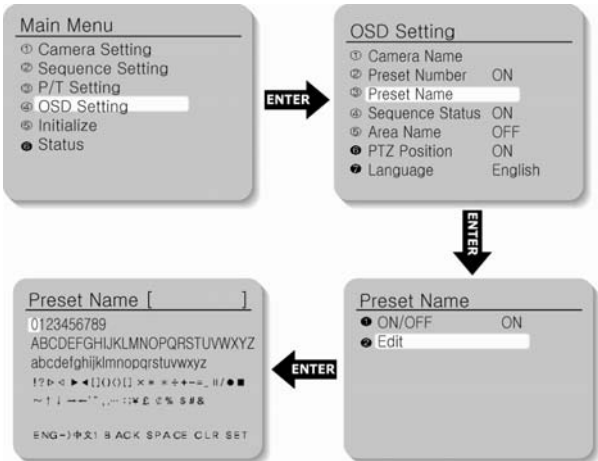

- **Edit** : A maximum of 12 characters consisting of English (or Chinese), numbers and special characters can be input for Preset Name.

- On/Off : The operation of this function is predetermined. Default setting is On.

5.5.4. Sequence Status

Display of the Sequence Group is set up. (Default setting is ON.)

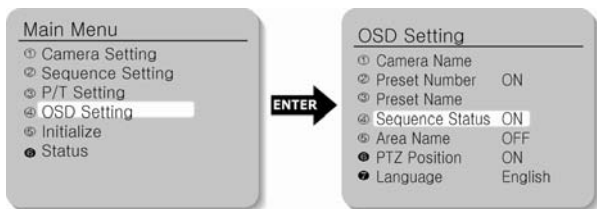

5.5.5. Area Name

Display of Area Name is set up.

When the Area Name is OFF, the Area Name cannot be displayed.

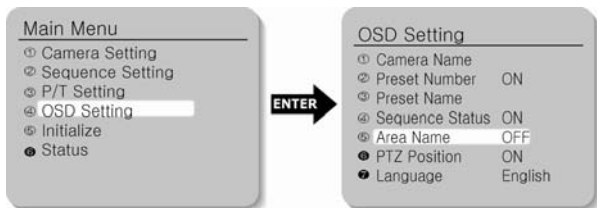

5.5.6. PTZ Position

Pan and Tilt position and Zoom magnification are displayed.

PTZ positions are not displayed in the OFF mode. (Only manual operation can display them.)

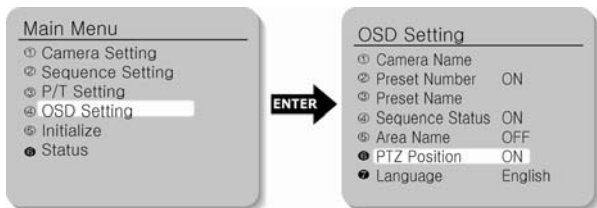

5.5.7. Language

The OSD can be displayed either in English (default setting), Chinese, French, German, Italy and Spanish.

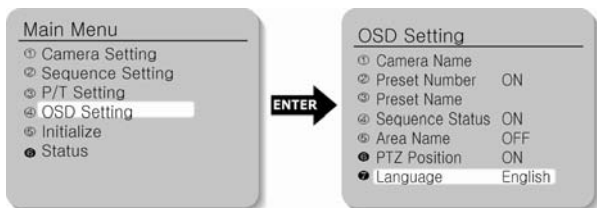

5.6. Initialization Setting

Initialization Menu



① Power On Reset

Camera is initialized into the original status of power input.

② Initial Position

If you want to set the default direction of the camera so that the camera faces that direction when the power is turned on, you can set up the desired Pan and Tilt for the camera.

③ Factory Default Settings

Camera is initialized into the factory default settings.

Data including Preset is deleted. This function is used for initialization all settings.

④ Camera Default Settings

If only the camera module is replaced due to camera module failure, the new camera module can be set up with the settings of the old camera module.

⑤ Auto Refresh

The electric circuit and the status of the equipment parts within the camera are optimized regularly. (The cycle can be set up.) If camera faces toward a certain source of light or if the settings cannot be kept because of the long time rotation filming of a certain area, the Auto Refresh function is used to maintain and reset the existing

camera settings. Default setting is OFF.

- OFF, 1-7 Days : This function is disabled in the OFF mode. 1-7 Days enables the Auto Refresh operation in the interval of the selected days. Auto Refresh takes less than 10 seconds. The message "Auto Refresh" disappears after finishing the operation.

5.7. Status

The status of PTZ camera setting is displayed.

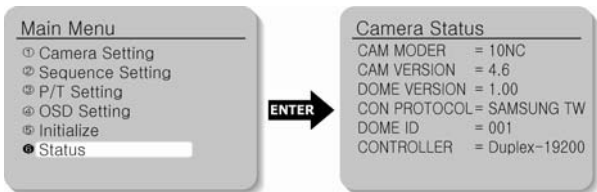

CAM MODEL= 10NC	Camera Model
CAM VERSION= 4.6	Camera S/W Version
DOME VERSION= 1.00	Control Board S/W Version
CON PROTOCOL=SAMSUNG TW	Protocol Setup
DOME ID= 001	Dome Camera ID
CONTROLLER= Duplex-19200	Communication Mode Setup

Ch6. Troubleshooting

If there are problems in operation, please refer to the items below. If the problem persists, please contact the agent you purchased this product from.

Problem	Solution
Nothing appears on the screen.	<ul style="list-style-type: none"> ▪ Please check the power connection. ▪ Please check the images after connecting the video signal line ▪ Open MS-DOS window to check whether 10X PTZ Network Camera SNP-1000A is connected to network. ※ In case of ping 192.168.1.100, replace it with IP address set up.
The video image is not clear.	<ul style="list-style-type: none"> ▪ Please check if the lens is clean. Please clean the lens with a clean cloth or brush. ▪ Please adjust the contrast feature of the monitor. ▪ Please make sure that the screen is not exposed directly to a bright light. Please move the camera if necessary.
The screen is dark.	<ul style="list-style-type: none"> ▪ Please adjust the contrast feature of the monitor. ▪ If you have an intermediate device, set the 75Ω/Hi-z properly, and check the terminals.
There is a problem with the camera operation. The camera surface is too hot and black stripes appear on the screen.	<ul style="list-style-type: none"> ▪ Please check if an appropriate power source to the camera complies with the manufacturer's standard requirement, or if the voltage keeps changing.

Problem	Solution
The MOTION DETECTION function is not working.	<ul style="list-style-type: none"> ▪ Please check if 'MOTION DETECTION' mode is turned on. ▪ Please check if the MD LEVEL is too low. ▪ Please check the setting of the MD AREA.
When camera cannot be controlled for Pan/ Tilt/ Zoom	<ul style="list-style-type: none"> ▪ Inspect the cables(power or network) connected to the device. ▪ Connect to Admin page to check whether user control is selected.
Colors are not quite right.	<ul style="list-style-type: none"> ▪ Please check the 'WHITE BAL' setting.
The screen is flickering.	<ul style="list-style-type: none"> ▪ Please check if the camera is facing directly into sunlight or fluorescent light.
DAYNIGHT(Auto) mode is not working.	<ul style="list-style-type: none"> ▪ Please check if the AGC menu is set to the OFF position.
SENS-UP function is not working.	<ul style="list-style-type: none"> ▪ Please check if the AGC menu is set to the OFF position. ▪ Please check if the SHUTTER menu is set to MANUAL mode. ▪ Please check the limit of SENS-UP AUTO mode.
Audio is not working	<ul style="list-style-type: none"> ▪ Please check the audio is selected from admin page. ▪ Please check speaker volume from the viewer. ▪ In case input sound through microphone at Viewer is not outputted through Audio Out of camera, please check whether Audio Out channel is selected at admin page. Or check whether microphone is available at Viewer.

Problem	Solution
	<ul style="list-style-type: none"> ▪ Please check audio driver is working in user's PC. ▪ Please use the enclosed Audio Extension Cable to install easily when connecting the audio cable.
Video is stopped	<ul style="list-style-type: none"> ▪ Please check whether network cable of 10X PTZ Network Camera SNP-1000A is correctly connected ▪ In case user uses hub or IP router, check whether these network equipments are working properly. ▪ Open MS-DOS window and check whether 10X PTZ Network Camera SNP-1000A is connected to network.
No image from web viewer	<ul style="list-style-type: none"> ▪ Click 'refresh (shortcut; F5) ' button at browser to recall the page ▪ Check whether power of camera and network cable is properly connected. ▪ Check whether computer is connected to network. ▪ If you use hub or router, check whether such equipments are properly operated. (Note: Open MS-DOS window and enter network ID of camera at ping 192.168.1.100) ▪ Connect to Admin page to check whether video output is selected.
Image transferred to FTP or by E-mail cannot be viewed	<ul style="list-style-type: none"> ▪ Video may not be viewed since Divx codec is not installed in user's PC. Divx codec can decode video compressed with MPEG4. Download and install the latest Divx codec, and check video. http://www.divx.com/divx/download

Appendix A. DDNS Usage

Registration process of DDNS is as following:

○ **Step1) Complete the registration form in iPOLiS website.**

The website is 'www.samsungipolis.com'.



Figure A-1. Website of iPOLiS

SIGNUP + My IPOLIS > Signup

 **Welcome to IPOLIS**
 We provide real-time online video service for IPOLIS products through this web browser.
 We recommend strongly every purchaser of IPOLIS products sign up for IPOLIS online.

LEGAL NOTICE

Legal Notice

NO. 1

NO. 2

Agree

NEXT

Figure A-2. Membership Registration: SIGNUP

SIGNUP + My IPOLIS > Signup

 **Welcome to IPOLIS**
 We provide real-time online video service for IPOLIS products through this web browser.
 We recommend strongly every purchaser of IPOLIS products sign up for IPOLIS online.

Manage your account

+ ID **AVAILABILITY**

+ PASSWORD * Create password of 6 to 12 characters in length containing letters A-Z or numbers 0-9.

+ PASSWORD Check

+ NAME

+ JOB

+ E-mail

+ ADDRESS **POSTAL CODE**

+ TEL

+ MOBILE PHONE - -

Manage company account

+ COMPANY

+ TEL

+ FAX

+ ADDRESS **POSTAL CODE**

SIGN UP **BACK**

Figure A-3. Membership Registration: Input your information.

○ Step2) Register the equipment after login.

WELCOME to IPOLIS !

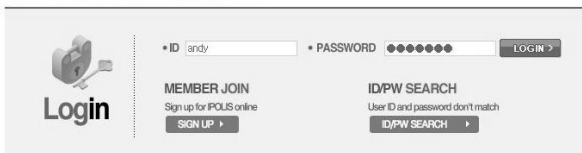

• ID • PASSWORD

MEMBER JOIN
Sign up for IPOLIS online

ID/PW SEARCH
User ID and password don't match

Figure A-4. Login

Product List My IPOLIS > Product List

 Current product list is displayed.
If wanted product is not in the list, click 'Product Registration' at the bottom.

NO	ID	Model	Location	Status	View	Information	Management
1	andy300	SNP-3300	AMBASSADOR HOTEL	OFF	<input type="button" value="View"/>	<input type="button" value="Check"/>	<input type="button" value="Edit"/> <input type="button" value="Delete"/>
2	andy550	SNC-550	Lab	OFF	<input type="button" value="View"/>	<input type="button" value="Check"/>	<input type="button" value="Edit"/> <input type="button" value="Delete"/>

Figure A-5. The list of registered equipment.

Product Registration My IPOLIS > Product Registration

Mandatory Information

http://www.samsungipolis.com/

ID(domain) *

- Create an ID of 4 to 12 characters in length containing letters A-Z or numbers 0-9.
- You should have exactly same ID with the item (product) ID to log on DDNS online service.
- Make sure the correct ID and click the item (product) ID.
- You may not able to change the initial domain name.

PASSWORD *

PASSWORD CHECK *

CLASSIFICATION * - Choose product category.

MODEL NUMBER * - Choose product model.

LOCATION *

- Determine the location to install the system (or camera).
- Designate the installation location within 10 alphabet letters.

DESCRIPTION

- Describe product for management purpose.

Figure A-6. Product Registration.
(Confirm repetition certainly at domain registration.)

HOME | STEMAP KOREAN | ENGLISH

IPOLIS WHAT IS IPOLIS PRODUCT DDNS SERVICE SUPPORT MY IPOLIS



Samsung Network Surveillance system

Anytime. Anywhere. In Real-time



MY IPOLIS

List of registered IPs *

 [SAMSUNG CITY WEBSITE](#)

 [DOWNLOAD CENTER](#)

 [DDNS SERVICE](#)

Product List My IPOLIS > Product List

 **Current product list is displayed.**
If wanted product is not in the list, click 'Product Registration' at the bottom.

NO	ID	Model	Location	Status	View	Information	Management
1	andy1000	SNP-1000	The RITZ-CARTON Seoul	OFF	<input type="button" value="View"/>	<input type="button" value="Check"/>	<input type="button" value="Edit"/> <input type="button" value="Delete"/>
2	andy9000	SNP-3000	AMBASSADOR HOTEL	OFF	<input type="button" value="View"/>	<input type="button" value="Check"/>	<input type="button" value="Edit"/> <input type="button" value="Delete"/>
3	andy990	SNP-500	Lab	OFF	<input type="button" value="View"/>	<input type="button" value="Check"/>	<input type="button" value="Edit"/> <input type="button" value="Delete"/>

[PRIVACY](#) / [LEGAL NOTICE](#) / [CONTACT US](#) [SAMSUNG TECHNICAL](#) [FAMILY SITE](#)

Figure A-7. The list of registered equipment.

○ Step3) Configure DDNS information in the equipment.

- Click the part of Network Configuration in website of Network Camera.
- Click “USE DDNS” in order to do “Enable” and input the address of DDNS Server.
(Default: www.samsungipolis.com)
- Enter the ID and Password that is written when register product is in iPOLiS website.

The screenshot shows the 'Network Setup' page in the iPOLiS web interface. The left sidebar contains navigation options: Live, Basic, Network, User, Pan/Tilt/Zoom, Motion Detection, Alarm/Sensor, Time, Log, Upgrade, System Reboot, and Log Out. The main content area is titled 'Network Setup' and contains the following configuration sections:

- Network Configuration:**
 - LAN: IP Address (192, 168, 1, 100), NetMask (255, 255, 255, 0), Gateway (192, 168, 1, 1), DNS1 (168, 126, 63, 1), DNS2 (168, 126, 63, 2).
 - xDSL: User Name, Password.
 - DHCP.
- Port/DDNS Configuration:**
 - Connection Port: 4000 (default: 4000)
 - HTTP Port: 80 (default: 80)
 - FTP Port: 21 (default: 21)
 - Use SWR: Enable, Disable
 - DDNS Server: www.samsungipolis.com
 - Use DDNS:
 - ID: andy1000
 - Password: *****

At the bottom of the configuration area are 'Save' and 'Cancel' buttons.

The Configuration of DDNS in SNP-1000A is Completed.

- **Step4) Confirm the connection status of relevant product in product list of iPOLiS website.**

MY IPOLIS

Product List

Current product list is displayed.
If wanted product is not in the list, click 'Product Registration' at the bottom.

NO	ID	Model	Location	Status	View	Information	Management
1	andy1000	SNP-1000	The RITZ-CARTON Seoul	ON	View	Check	Edit Delete
2	andy2000	SNP-2000	AMBASSADOR HOTEL	OFF	View	Check	Edit Delete
3	andy350	SNP-350	Lab	OFF	View	Check	Edit Delete

Product Registration

Figure A-8. The List of Product.

Be able to confirm the information of connected equipment if click <check> button of 'Product information'.

Product Information

• ID(domain)	andy1000
• PRODUCT	
• MODEL NUMBER	SNP-1000
• CLASSIFICATION	Urban security
• LOCATION	The RITZ-CARITON Seoul
• REGISTRATION DATE	2008-05-22
• MAC ADDRESS	

[x CLOSE](#)

Figure A-9. Product information

Move to Login website of relevant product if click <view> button of 'view'.

The buttons which are <Edit> and <Delete> of 'product management' move to relevant page through input password to item that fertilize or erase information of registered equipment in List of product.

Only, 'ID(Domain)' of product should establishes again as 'ID(Domain)' after deleting because it can't be fertilized.

WELCOME to IPOLIS!



• ID • PASSWORD

[LOGIN >](#)

MEMBER JOIN

Sign up for IPOLIS online

[SIGN UP >](#)

ID/PW SEARCH

User ID and password don't match

[ID/PW SEARCH >](#)

Figure A-10. Edit/Delete

Specifications

Camera Part

Items	SNP-1000AN	SNP-1000AP
Imaging device	1/4" Color Vertical Double Density Interline CCD. 410,000pixel	
TV	NTSC	PAL
Total Number of Pixels	811(H) X 508(V)	795(H) X 596(V)
Valid Pixel	768(H) X 494(V)	752(H) X 582(V)
Horizontal Scan Frequency	15.734kHz	15.625kHz
Vertical Scan Frequency	59.94Hz	50Hz
Synchronization	Internal Sync	
Image Output	1.0p-p/75Ω	
S/N Ratio	Higher than 50dB (AGC OFF)	
Horizontal Resolution	520 TV Lines (Color)/570 TV Lines(B/W)	
Minimum Light for Object	0.7Lux(Color), 0.1Lux(B/W)/(@50IRE), 0.0007Lux (Day & Night is On.)/(@50IRE)	
Electronic Shutter	Auto/Manual (1/60 - 1/120,000)	Auto/Manual (1/50 - 1/120,000)
Sens-Up	ON (x2 - x128 Fields) / OFF	
Day & Night	ICR(Filter Switching) ON/OFF	
White Balance	ATW(Indoor/Outdoor Selection)/AWC/ Manual (1,800K - 10,500K)	
Flickerless Adjustment	Fixed Shutter Speed (1/100)	Fixed Shutter Speed (1/120)
Iris	Auto/Manual (Iris Level Adjustment Mode)	
Gain Control	Low, Middle, High, Off	
OSD Display	ON/OFF	
Outline Correction	Adjustable Level	
Focal Length	F3.8mm(WIDE)~F38.0mm(TELE), 10X Optical Zoom	
Digital Zoom	OFF, 2~10X Selection (Total 100X Zoom)	
Maximum Aperture Rate	Wide Angle 1:1.6, Tele 1:2.8	
Coverage Angle	Wide: 51.2°(H) X 39.3°(V) Tele: 5.58°(H) X 4.27°(V)	
Proximity Distance	1.5m(Tele)	
Horizontal Rotation Angle	350°	
Horizontal Rotation	Manual/Program	

Items	SNP-1000AN	SNP-1000AP
Horizontal Rotation Speed	Manual: 0.5° ~ 70°/s(64 levels) Preset: 0.5° ~ 140°/s(64 levels)	
Horizontal Minimum Moving Angle	0.02°	
Vertical Rotation Angle	-5° ~ 185° (Digital Flip)	
Vertical Rotation	Manual/Program	
Vertical Rotation Speed	Manual: 0.5° ~ 150°/s(64 levels) Preset: 0.5° ~ 100°/s(64 levels)	
Vertical Minimum Moving Angle	0.02°	
Preset Position	Max 128 points	
Area Masking	Max 4 locations	
Alarm	2 Alarm Inputs	
	1 Alarm Outputs (Relay: NC/NO/COM, 2A 30VDC Max)	
Operating Temperature	0°C ~ 40°C	
Operating Humidity	20% ~ 75%(Except for dew condensation)	
Power, Voltage	DC 12V±10%	
Power Consumption	Operating 8.5Watts below	
Dimension	Ø110 X 134.8mm	
Weight	Less than 0.85kg	
Option	- Wall Mount Bracket : STB-280PW - Wall Mount Bracket : STB-230PW - Dome Housing : STH-1000PI	

※ The product design and dimensions may change without previous notice for improvement of performance.



Note

- The copyright of this manual belongs to Samsung Techwin Co. Ltd.
- Parts or the whole of this manual cannot be reproduced or transmitted by any electric, mechanic or audio method without the authorized written approval of Samsung Techwin.
- The contents of this manual may be changed for an improvement of functions.

Network Part

Items	SNP-1000AN	SNP-1000AP
Output Resolution	NTSC : 704 x 480(D1), 704 x 240(Half D1), 352 x 240(CIF) PAL : 704 x 576(D1), 704 x 288(Half D1), 352 x 288(CIF)	
Output Video Format	MPEG4 / MJPEG Selectable	
Video Compression Stage	5 stages (Very Low, Low, Middle, High, Very High)	
Compression transmission speed	NTSC : MAX 30 frame/sec PAL : MAX 25 frame/sec	
Audio Format	Bi-directional audio, 8KHz ADPCM	
Ethernet	10/100Mbps	
Protocol	HTTP, TCP/IP, FTP, SMTP, DHCP, DNS, DDNS, NTP, PPPOE	
Dynamic IP	Supports XDSL and DHCP	
DDNS	Supports DDNS	
Area Zoom	Supports Area Zoom function	
Max. User	20 Users	
S/W	Supply Network Manager Standard Installation Program	

※ The product design and dimensions may change without previous notice for improvement of performance.

Dimension

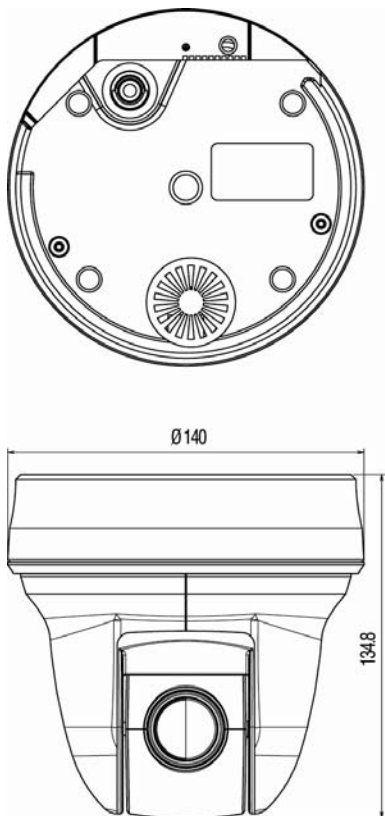

SAMSUNG TECHWIN

The Samsung logo, consisting of the word "SAMSUNG" in a bold, sans-serif font, enclosed within a black, horizontally-oriented oval shape.

SALES NETWORK

SAMSUNG TECHWIN CO., LTD.
145-3, Sangdaewon-dong, Jungwon-gu,
Seongnam-si, Gyeonggi-do, 462-120, Korea
Tel: +82-31-740-8151~8 Fax: +82-31-740-8145

SAMSUNG OPTO-ELECTRONICS AMERICA, LTD.
1480 Charles Willard St. Carson, CA90746
Tel: +1-310-632-1234 Fax: +1-310-632-2195

SAMSUNG OPTO-ELECTRONICS UK, LTD.
Samsung House, 1000 Hillswood Drive,
Hillswood Business Park Chertsey, Surrey KT16 OPS
Tel: +44-1932-45-5308 Fax: +44-1932-45-5325

www.samsungtechwin.com
www.samsungipolis.com

P/NO : Z6806.0915.01B