

user's manual instrukcja obsługi



eng

pl

NV-DVR04 NV-DVR04NET

NOVUS[®]

user's manual



eng

NV-DVR04 NV-DVR04NET

NOVUS[®]

INFORMATTIONS

EMC (89/336/EEC) and LVD (73/23/EEC) Directives

CE Marking

 Our products are manufactured to comply with requirements of following directives and national regulations implementing the directives:

- Electromagnetic compatibility EMC 89/336/EEC with further amendments.
- Low voltage LVD 73/23/EEC with further amendment. The Directive applies to electrical equipment designed for use with a voltage rating of between 50VAC and 1000VAC as well as 75VDC and 1500VDC.

WEEE Directive 2002/96/EC

Information on Disposal for Users of Waste Electrical and Electronic Equipment

 This appliance is marked according to the European Directive on Waste Electrical and Electronic Equipment (2002/96/EC) and further amendments. By ensuring this product is disposed of correctly, you will help to prevent potential negative consequences for the environment and human health, which could otherwise be caused by inappropriate waste handling of this product.

The symbol on the product, or the documents accompanying the product, indicates that this appliance may not be treated as household waste. It shall be handed over to the applicable collection point for the waste electrical and electronic equipment for recycling purpose.

For more information about recycling of this product, please contact your local authorities, your household waste disposal service or the shop where you purchased the product.

RoHS Directive 2002/95/EC



Concerning for human health protection and friendly environment, we assure that our products falling under RoHS Directive regulations, regarding the restriction of the use of hazardous substances in electrical and electronic equipment, were designed and manufactured in compliance with mentioned regulation. Simultaneously, we claim that our products were tested and do not contain hazardous substances exceeding limits which could have negative impact on human health or natural environment.

WARNINGS AND PRECAUTIONS

WARNING!



READ, KEEP AND FOLLOW THESE INSTRUCTIONS. ALL THE SAFETY AND OPERATING INSTRUCTIONS SHOULD BE READ BEFORE THE PRODUCT IS OPERATED.

WARNING:

TO REDUCE THE RISK OF FIRE OR ELECTRIC SHOCK DO NOT EXPOSE THIS UNIT TO RAIN OR MOISTURE IF THIS UNIT IS DESIGNED FOR INDOOR USE ONLY.

WARNING!

USER IS NOT ALLOWED TO DISASSEMBLE THE CASING IF THERE ARE NO USER-SERVICEABLE PARTS INSIDE THIS UNIT. ONLY AUTHORIZED SERVICE PERSONNEL MAY OPEN THE UNIT

INSTALLATION AND SERVICING SHOULD ONLY BE DONE BY QUALIFIED SERVICE PERSONNEL AND CONFORM TO ALL LOCAL REGULATIONS

WARNING!

DIGITAL MULTIPLEXER IS SENSITIVE TO ELECTROSTATIC DISCHARGES THEREFORE IT SHOULD BE USED IN ACCORDANCE WITH OPERATING AND MAINTENANCE RULES FOR DEVICES BASED ON CMOS/MOSFET TECHNOLOGY.

INFORMATION

Data included in the following user's manual is up to date at the time of printing. Novus Security Sp z o.o. holds exclusive rights to modify this manual. The producer reserves the rights for device specification modification and change in the design without prior notice.

WARNINGS AND PRECAUTIONS

1. Installation and servicing of NV-DVR1004 or NV-DVR1004NET should only be carried out by qualified service personnel and conform to all local regulations.
2. Do not place the Multiplexer in areas where ventilation openings might be blocked or covered.
3. There are no user-serviceable parts inside this unit. Only authorized service personnel may open the unit. The equipment should be protected from mechanical damage and kept clean at all times.
4. Protect this device from being exposed to dust and moisture. In the event of the Multiplexer coming into direct contact with water unplug the device immediately and contact qualified service personnel. Dusty (soiled/dirty) equipment may be the cause of fire and / or electrical shock.
5. Unplug the unit from the outlet before cleaning. This device can be cleaned only with a clean damp cloth. Try to avoid using chemically active liquid cleaners or aerosol. In the event of strong dirt it is allowed to use gentle cleaning lotion.
6. Power supply wires as well as signal wires should be fixed in the way that there is no risk of mechanical damage, Please take extra caution not to overload sockets and extension cords to prevent from the risk of fire.
7. In order to prevent the unit from damage, video channel and signal wires should be equipped with appropriate surge protection device conforming to European Union standards. We also advice utilizing video and data transmission protection.
8. It is not allowed to operate this device in conditions not complying with exploitation requirements in the range of power supply, relative air humidity or air temperature..
9. Metal objects cannot be put inside the device. It can cause major malfunction and/or damage the unit. In the event of the above, user should contact service immediately for further assistance.

eng

TABLE OF CONTENTS

1. FOREWORD INFORMATION	8
1.1 Main characteristics	8
1.2 NV-DVR1004 and NV-DVR1004NET TECHNICAL SPECIFICATION	9
2. DEVICE POWER UP	10
2.1 Preparing the equipment for operation	10
2.2 Electric connectors of NV-DVR1004 back panel.....	11
2.3 Electric connectors of NV-DVR1004NET back panel	12
2.4 External Devices Connection.....	13
2.5 HDD Installation.....	15
2.5.1 Swappable bay HDD installation	15
2.5.2 Internal HDD installation (inside the Multiplexer)	15
2.6 Device power on and power off.....	16
3. FRONT PANEL DESCRIPTION	17
3.1 NV-DVR1004 front panel description	17
3.2 NV-DVR1004NET front panel description.....	19
4. DEVICE MENU	21
4.1 System.....	22
4.2 Cameras.....	24
4.3 Recording.....	25
4.4 Alarm setup	27
4.5 Schedule.....	28
4.6 Event List	29
4.7 HDD Management	30
4.8 Network setup	31
4.9 Default setup	32
5. RECORD	33
6. PLAYBACK	34
6.1 Time Search	34
6.2 Searching Recorded Data From The Event List	35
7. BACKUP	36
7.1. HDD backup on PC.....	36
7.2. Compact Flash Backup (NV-DVR-1004NET only).....	36
7.2.1 Single Image Backup	36
7.2.2 AVI Backup.....	37
8. ALARM DEVICES INPUTS AND OUTPUTS CONNECTION	38
9. SPEED DOME CAMERA - CONNECTION AND CONTROL (NV-DVR1004NET ONLY)	39
9.1 Novus Speed Dome Camera Connection	39
9.2 Camera Control.....	41
10. NETWORK FUNCTION (NV-DVR1004NET)	42
10.1 Computer Hardware Requirements	42
10.2 Network Settings Configuration	43
10.3 Initiating Connection.....	44
10.4 User Interface View	45
10.5 User Interface Function Description.....	45
10.5.1 Display Settings	45
10.5.2 Transmission Speed	46
10.5.3 Saving images on PC	47
10.5.4 Network Applet Configuration.....	49
10.5.4.1 Multiplexer Logs - system registry.....	49
10.5.4.2 System Settings	49
10.5.4.3 User Accounts Management.....	50
10.5.4.4 Network Connection Parameters	50
10.5.4.5 Alarm Event Notification	51
10.5.6 Multiplexer Remote Control	52

FOREWORD INFORMATION

1. FOREWORD INFORMATION

Digital Multiplexer NV-DVR1004 / NV-DVR1004NET was designed specifically to work in CCTV surveillance systems. This device incorporates the advantages of digital image recording with the simplicity of installation and operation of time lapse recorders. This device utilizes very effective compression method, ensuring high quality and detailed images.

eng

1.1 Main characteristics.

- ✍ User friendly interface, with functions known from analog multiplexers;
- ✍ The simplicity and convenience of using HDD instead of video tapes;
- ✍ Immediate access to recorded material;
- ✍ Menu access protected by password;
- ✍ M-JPEG compression algorithm with various image quality settings;
- ✍ Schedule recording with selection of mode and recording speed;
- ✍ The possibility of installing two HDD 3.5'' IDE, one of them placed in swappable bay;
- ✍ Simultaneous real time display of all channels;
- ✍ Adjustable recording speed, up to 25 fields per second (PAL);
- ✍ Alarm recording function;
- ✍ Motion detection function;
- ✍ The possibility of remote control and viewing the images using the Ethernet (protocol TCP/IP) (NV-DVR1004NET only);
- ✍ Files backup feature (JPG, AVI format); available methods: Compact Flash memory card backup, PC backup, network backup (NV-DVR1004NET only);
- ✍ PTZ cameras control using front panel buttons and network applet (NV-DVR1004NET only);

NV-DVR04 and NV-DVR04NET TECHNICAL SPECIFICATION

1.2. NV-DVR04 and NV-DVR04NET TECHNICAL SPECIFICATION

	NV-DVR1004	NV-DVR1004NET
Multiplexer mode	simplex	
Video inputs	4 loop-through (BNC inputs), 1Vp-p/75 Ω	
Video output	1 main monitor output (BNC)	
Alarm inputs	4	
Alarm output	1, relay	
Recording resolution	640 x 272	
Compression algorithm	M-JPEG	
Recording modes	scheduled, alarm / motion recording	
Display speed	up to 100 images /s (live display)	
Motion detection	2 zones, adjustable zone's size and sensitivity	
Recording schedule	record mode selection (continuous, alarm or no recording) for each hour of a day	
Recording searching	time / date search or event search	
Event log	up to 64 events per HDD	
Display format	1, 4	
Video loss detection	yes	
HDD	up to 2 HDD's (up to 400GB each), one in HDD swappable bay	
Recording backup	PC backup by means of PC Viewer	PC backup by means of PC Viewer, Compact Flash backup, network backup
External backup	1 x RS-485 - for PTZ control	LAN. 1 x RJ-45, 1 x RS-485 - for PTZ control
PTZ control	by means of front panel buttons	by means of front panel buttons or network
PTZ protocols	Novus-C, Novus-C1, Novus-C2, Pelco-D	Novus-C, Novus-C1, Novus-C2, Pelco-D
Control	front panel buttons	front panel buttons, network
Menu	multilingual OSD	
Password authorization	one admin password (4 digits)	
Auto system recovery	hardware watchdog	
Power supply	230 VAC	
Power consumption	approx. 16 VA w/o HDD, approx. 40VA with 1 HDD, approx. 50 VA with 2 HDD's	
Weight	4 kg	
Operating temperature	0°C~ +40°C;	
Operating relative humidity	0%~80~(without condensation)	

eng

DEVICE POWER UP

2. DEVICE POWER UP

2.1 Preparing the equipment for operation.

Please take extra caution when unpacking the device.

Please ensure that following items are included in the package:



Digital Multiplexer NV-DVR04 or NV-DVR04NET



Net cross cable for Multiplexer-PC connection
(NV-DVR1004NET only)



HDD Swappable Bay lock-keys



Power Supply Cord



User's Manual



CD containing manual and software



Compact Flash Card
(NV-DVR1004NET only)



Compact Flash Card Reader
(NV-DVR1004NET only)

If the equipment has been damaged during transport, the contents of package should be packed back to the original box. Contact the supplier for further assistance.

WARNING !

It is not allowed to power on the equipment directly after it has been brought from a place of low temperature. If the device has been brought from the area of lower temperature the user should wait until the equipment warms up slowly and reaches the room temperature.

Condensation of moisturized air may cause short circuit and damage the device.

DEVICE POWER UP

2.2 Electric connectors on back panel of the NV-DVR04 multiplexer.

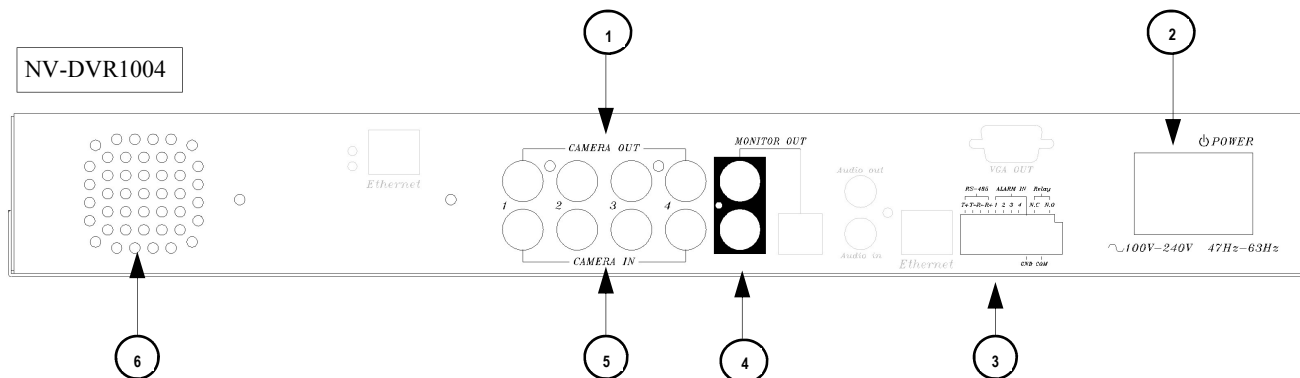

1. **CAMERA OUT** : video loop-through output;
2. **POWER**:
~90~260V: power switch ON/OFF;
power supply socket;
3. **RS-485,ALARM IN, Relay**: RS-485 port for PTZ control, 4 alarm inputs, 1 alarm relay;
4. **MONITOR OUT**: main monitor connection, BNC connector
5. **CAMERA IN**: video inputs for camera connection;
6. : cooling fan (do not block or cover!);

eng

DEVICE POWER UP

2.3 Electric connectors on back panel of the NV-DVR04NET multiplexer.

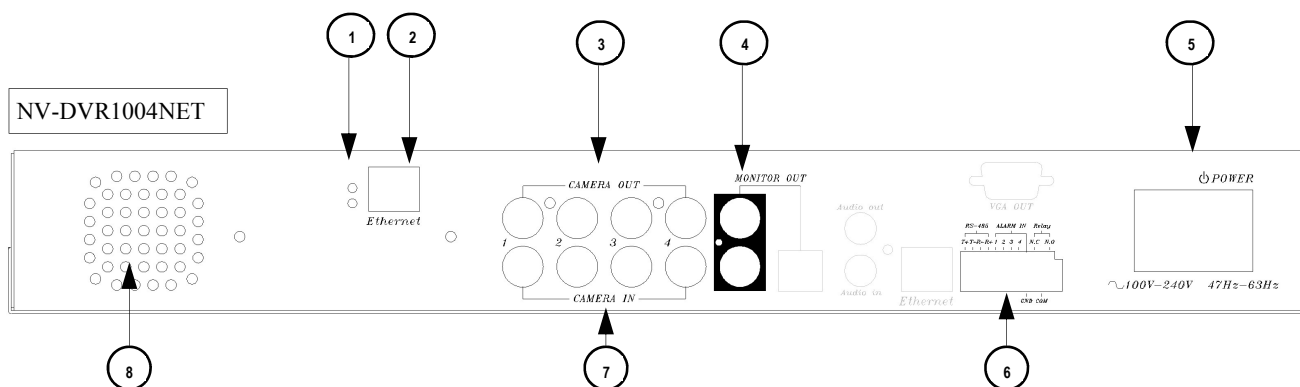

- | | | |
|----|--------------------------------|--|
| 1. | | network activity LEDs; |
| 2. | Ethernet: | RJ-45 socket for net computer connection; |
| 3. | CAMERA OUT : | video loop-through output; |
| 4. | MONITOR OUT: | output connections for Main monitor; user might select one of various split screen display options, 2 Composite connectors |
| 5. | POWER, ~100~240V: | power supply socket and power switch; |
| 6. | RS-485,ALARM IN, Relay: | RS-485 port for PTZ control, 4 alarm inputs, 1 alarm relay; |
| 7. | CAMERA IN: | video inputs for camera connection; |
| 8. | | : cooling fan (do not block or cover!); |

2.4 External Devices Connection

All installation procedures should be conducted by qualified personnel. Before device installation and operation please analyze the scheme shown below. Depending on specific user needs and requirements each system will consist of various number of external devices. Monitors, cameras and other devices are not included and must be purchased separately. Detailed description of devices connection is included in next chapters of this manual.



eng

DEVICE POWER UP



eng

2.5 HDD Installation

NV-DVR1004 and NV-DVR1004NET Digital Multiplexers allows to install two HDD's. One of these disks can be installed inside the device, second might be placed in swappable bay.

NOTICE: Producer advices utilizing HDD's manufactured by Maxtor or Hitachi.
Max. allowed capacity of single HDD is 400GB.

WARNING: Producer strongly advices against utilizing Samsung or Western Digital HDD's.
Novus does not take any responsibility for problems caused by using improper HDD.

Before installing HDD please make sure that jumpers are set properly!
In the event of using only one HDD it must be set in MASTER mode. In the event of two HDD's, one of them must be set in MASTER mode and the second in SLAVE mode. HDD configuration of specified type and manufacturer is described in the HDD manual supplied with the HDD.

WARNING: Take into consideration that in case of using HDD from other device (other multiplexer or PC) while first multiplexer booting all data is erased.

2.5.1 Swappable bay HDD installation

Before installation disconnect power supply cord.
Place the properly set HDD in swappable bay and then screw it on to the casing utilizing 4 supplied screws. Place the swappable bay in the Multiplexer and close it with the key, attached in the package.

2.4.2 Internal HDD installation (inside the DVR)

NOTICE:

Internal HDD should be installed by qualified service personnel.
The housing of the Multiplexer can be opened only for internal HDD installing according to the installing procedure described in this manual on page 52.
If the Multiplexer housing is opened for a different purpose the warranty is void.

DEVICE POWER UP

2.6 Device turn on and turn off.

Before turning on the device please make sure that the power supply (voltage and frequency) conforms to device requirements. Also make sure that the power switch is set to „0”, HDD swappable bay is locked with the key and that the all external devices are connected properly.

WARNING: We do not advice to connect any additional devices (such us cameras, monitors, etc..) while device operation.

eng

Device power on is activated by switching the power switch to position „1”.

The loading procedure of the operating system takes about 30 seconds.

During this procedure various information will appear on the screen.

During this procedure please do not press any buttons on the front panel of this device.

The loading procedure is finished when camera images will appear on the Main monitor along with their descriptions and the system time.

To power off the device stop the recording and shut down the device using power switch.

FRONT PANEL DESCRIPTION



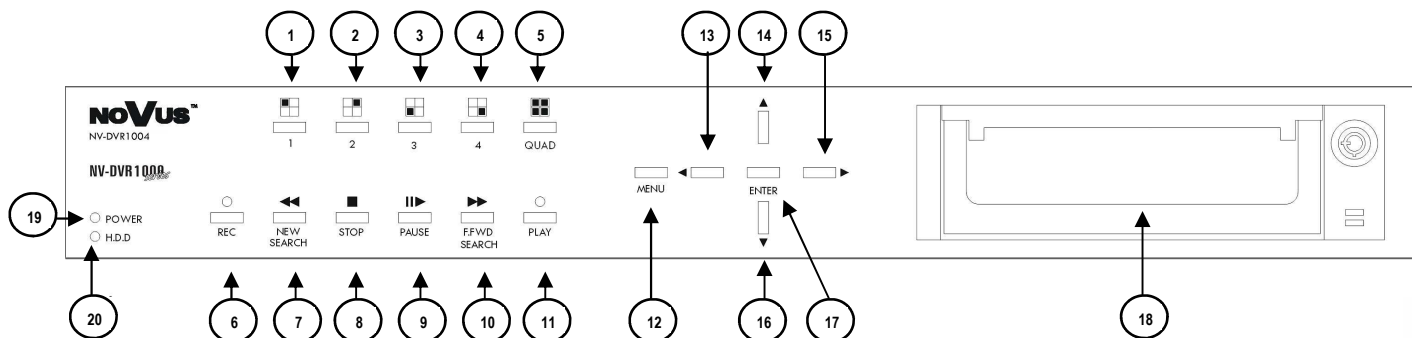

3. NV-DVR1004 Front Panel Description



eng

Icon	Function
 1	1. Channel 1 selection. 2. Password input, digit 1.
 2	1. Channel 2 selection. 2. Password input, digit 2.
 3	1. Channel 3 selection. 2. Password input, digit 3.
 4	1. Channel 4 selection. 2. Password input, digit 4.
 Quad	Quad display selection (2x2).
 Rec	Recording ON button;
 Rew Search	Rewind playback. Pressing that button will give following rewind speeds: x2, x8, x16.
 STOP	Playback stop.
 Pause	Pause. Press that button in playback mode to play field by field.

FRONT PANEL DESCRIPTION

Icon	Function
10  <i>F.Fwd Search</i>	1. Fast Forward playback. Pressing that button will give following fast forward speeds: x2, x8, x16. 2. In live display mode pressing that button activates PTZ control mode.
11 <i>PLAY</i>	Playback menu entering.
12 <i>MENU</i>	On Screen Display menu activating;
13 	1. " <i>Left</i> " cursor button 2. In PTZ mode that button moves left the camera.
14 	1. " <i>Up</i> " cursor button 2. In PTZ mode that button moves up the camera.
15 	1. " <i>Right</i> " cursor button 2. In PTZ mode that button moves right the camera.
16 	1. " <i>Down</i> " cursor button 2. In PTZ mode that button moves down the camera.
17 <i>ENTER</i>	1. In programming mode that button is used to enter sub-menu and edition field; 2. In live/record mode that button is used to get HDD's capacity/occupancy information
18	HDD swappable bay.
19 <i>POWER</i>	Power on indicator.
20 <i>H.D.D.</i>	LED informing that HDD's is in use.

eng

FRONT PANEL DESCRIPTION



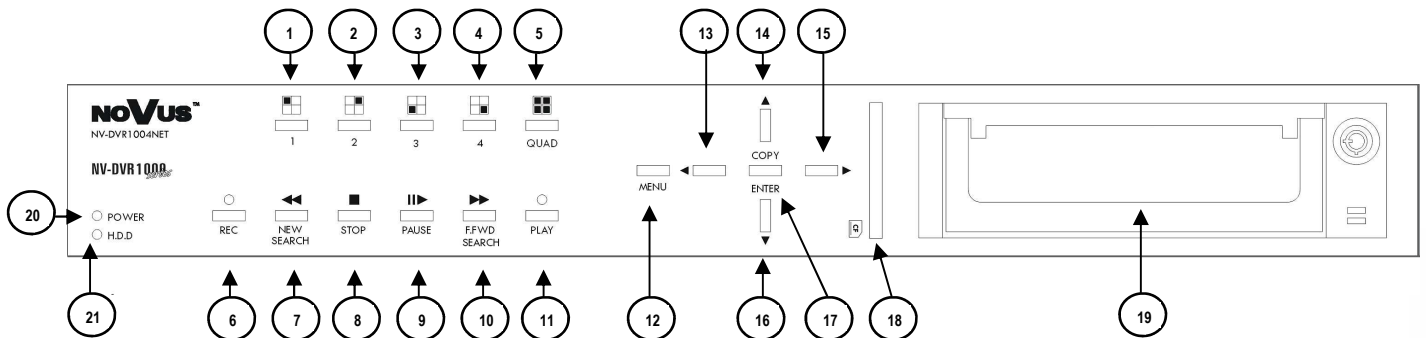



3.2 NV-DVR1004NET Front Panel Description



eng

Icon	Function
1 1	1. Channel 1 selection. 2. Password input, digit 1.
2 2	1. Channel 2 selection. 2. Password input, digit 2.
3 3	1. Channel 3 selection. 2. Password input, digit 3.
4 4	1. Channel 4 selection. 2. Password input, digit 4.
5 Quad	Quad display selection (2x2).
6 Rec	Recording ON button;
7 Rew Search	Rewind playback. Pressing that button will give following rewind speeds: x2, x8, x16.
8 STOP	Playback stop.
9 Pause	Pause. Press that button in playback mode to play field by field.

FRONT PANEL DESCRIPTION

Icon	Function
10  F.Fwd Search	1. Fast Forward playback. Pressing that button will give following fast forward speeds: x2, x8, x16. 2. In live display mode pressing that button activates PTZ control mode.
11 PLAY	Entering playback menu.
12 MENU	On Screen Display menu activating;
13 	1. "Left" cursor button 2. In PTZ mode that button moves left the camera.
14 	1. "Up" cursor button 2. In PTZ mode that button moves up the camera.
15 	1. "Right" cursor button 2. In PTZ mode that button moves right the camera.
16 	1. "Down" cursor button 2. In PTZ mode that button moves down the camera.
17 COPY ENTER	1. In programming mode that button is used to enter sub-menu and edition field; 2. In live/record mode that button is used to get HDD's capacity/occupancy information 3. In playback mode that button activate CF backup.
18 	Compact Flash card slot.
19	HDD swappable bay.
20 POWER	Power on indicator.
21 H.D.D.	LED informing that HDD's is in use.

4. DEVICE MENU

Digital Multiplexers NV-DVR1004NET and NV-DVR1004NET are equipped with multi level OSD (on screen display) sub-menus. This menus are used to program settings and execute functions such us playback or copying. Menu is displayed in English.

Notice: Device OSD menu is available only while recording is inactive (see chapter 5).

In order to enter device menu press *MENU* button.

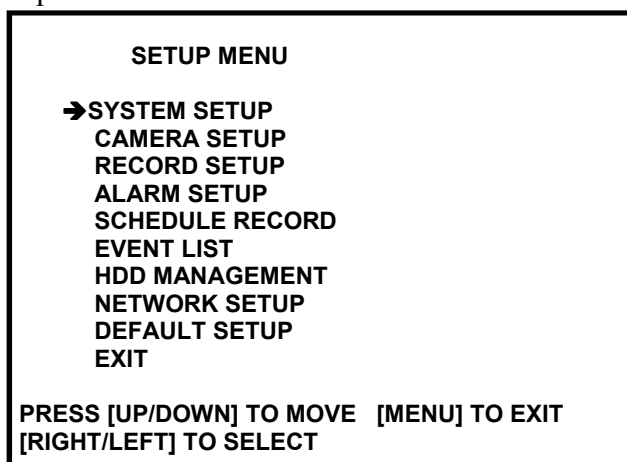

eng

Main menu consists of 9 sub-menus. The contents of sub-menus are described on following pages of this manual.

This buttons ▲ ▼ are used to select menu items.

Selected item is pointed by these icons ➔, ▲ or ▼.

Press ▶ or ◀ button in order to confirm the selection, enter the sub-menu or to modify selected value.

Exiting the menu accepts and saves inputted modifications.

In order to leave selected menu or to return to the higher level menu from individual sub-menus and modification fields *EXIT* option should be selected and *ENTER* button must be pressed. Pressing *MENU* button acts similar to the procedures described above.

NOTICE: In case factory default OSD language is different than desired press MENU button, select first menu item, press ENTER, select 4th menu item and choose desired language, exit from menu. An example below shows changing language from Polish to English.

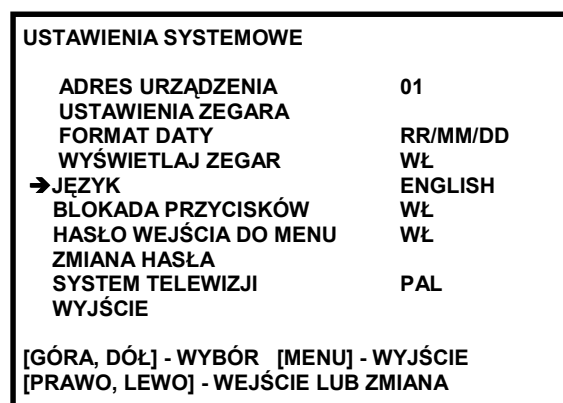
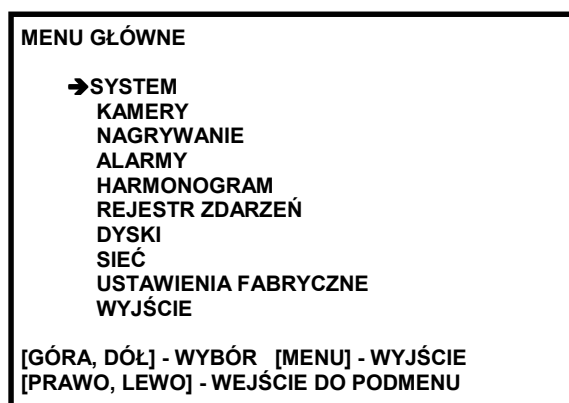

DEVICE MENU

4.1 System Setup

SYSTEM SETUP	
DVR ID NUMBER	1
SET TIME/DATE	
TIME DISPLAY MODE	YY/MM/DD
TIME DISPLAY	ON
LANGUAGE SELECT	ENGLISH
KEY LOCK	ON
MENU SETUP PROTECTION	ON
CHANGE PASSWORD	
SYSTEM SELECT	PAL
EXIT	

PRESS[UP,DOWN] TO MOVE [MENU] TO EXIT
[RIGHT, LEFT] TO SELECT

Utilizing **SYSTEM SETUP** menu following system settings may be applied:

- (1) **DVR ID NUMBER:** DVR id; It is needed when using external keyboard to remote control DVR (this option is inaccessible now)
- (2) **SET TIME DATE:** after selecting this item and pressing **ENTER** button the time/date menu appears.

TIME	
2005/MAY/10 13:59:46 TUE	
PRESS [RIGHT, LEFT] TO MOVE	[MENU] TO EXIT
[UP, DOWN] TO CHANGE	

- (3) **TIME DISPLAY MODE:** This option allows to define time/date format: **YY/MM/DD**; **MM/DD/YY**; **DD/MM/YY**.
- (4) **TIME DISPLAY:** If this option is set to **ON**, time will be displayed on the upper part of the screen.

DEVICE MENU

-
- (5) **LANGUAGE SELECT:** OSD language selection; Polish and English are available
 - (6) **KEY LOCK :** Select *ON* to lock (deactivate) front panel buttons.
 - (7) **MENU SETUP PROTECTION:** After selection *ON* menu button operation is protected by 4 digits password. Together with Key Lock feature it gives complete unit protection.
 - (8) **CHANGE PASSWORD:** This option is used to set a 4 digit password.

PASSWORD CHANGE

CURRENT PASSWORD : ----

NEW PASSWORD : ----

PASSWORD CONFIRM : ----

eng

NOTICE: Factory default password: 1111.

In order to change the password you should input correctly present password (using 1, 2, 3, 4 buttons), and then input two times a new one.

WARNING: Please don't forget new password. In order to recover forgotten password service help is indispensable.

- (9) **SYSTEM SELECT:** This option is used to select TV system standard. You can select *PAL* or *NTSC*

DEVICE MENU

4.2 Cameras

CAMERA SETUP	
→CAMERA SELECT	[[CAM1]]
CAMERA RECORD	ON
MOTION SENSITIVITY	2
MOTION AREA SETUP	
BRIGHTNESS	STANDARD
CONTRAST	STANDARD
HUE	STANDARD
CAMERA TITLE EDIT	
EXIT	
PRESS [UP/DOWN] TO MOVE [MENU] TO EXIT	
[RIGHT/LEFT] TO SELECT	

In **CAMERA SETUP** menu following settings can be set for each video channel:

- (1) **CAMERA SELECT** : This option is used to select specific channel number for the camera, of which settings should be displayed or modified
- (2) **CAMERA RECORD**: If this option is set to **OFF** the image from selected camera will not be recorded however it still will be displayed on the screen. In order to record image from selected camera set this option to **ON**;
- (3) **MOTION SENSITIVITY**: This option allows to define the sensitivity of motion detection. Using this option allows to evade unnecessary false alarms caused for example by moving leafs etc.. This option can be adjusted in the range from 1 to 6. The higher value of motion detection makes it more sensitive.
- (4) **MOTION AREA SETUP**: Using this option allows to define two rectangular blocks for motion detection. In order to display buttons description press **QUAD**. Three initial block types can be defined: **1** - blocks with smallest area, **2** - blocks with default area, **3** - blocks with biggest area. Each block can be extended and placed according to user individual needs. After selecting initial block's area press cursor keys to place it in required screen place. Then press **PLAY** and use cursor keys to extend it. To change second block press **PLAY** once more and act as at first block. Notice! Only marked area is analyzed for motion detection.

(5) **BRIGHTNESS**

CONTRAST

HUE: This menu options allow to adjust the parameters of displayed image to user individual needs and requirements. The default value is **50**;

Notice: Adjusting the parameters of image also take effect on recordings.

- (6) **CAMERA TITLE EDIT**: This option allows to edit camera title. In order to edit camera title place cursor “^” under demanded character and press **PLAY**. Follow this action until all characters will be selected. Press **MENU** to finish.

4.3 Recording

RECORD SETUP	
→RECORD MODE	MUX
NORMAL RECORD FPS	12P
ALARM RECORD FPS	25P
ALARM RECORD DWELL	5 SEC
RECORD QUALITY	HIGH
EXIT	
PRESS [UP/DOWN] TO MOVE [MENU] TO EXIT	
[RIGHT/LEFT] TO SELECT	

eng

In **RECORD SETUP** menu following settings can be adjusted:

- (1) **RECORD MODE:** This option allows to define recording mode. Multiplexer mode (*MUX*) means that images from each channel are stored one after another. Later on full screen as well as quad playback are available. Quad mode (*QUAD*) means that there are all channels recorded in the same time in quad division. Later on there is only quad playback mode available.
- (2) **NORMAL RECORD FPS:** This option is used to set recording speed for normal and schedule recording. Speed values are expressed in fields per second rate. Following values are available: *25, 12, 8, 6, 4, 3, 2, 1*. Recording speed applies to entire Multiplexer. Depending on number of recording cameras the Multiplexer resources are equally divided between each camera.
- (3) **ALARM RECORD FPS:** This option is used to set recording speed during alarm mode (alarm inputs and motion detection). Speed values are expressed in fields per second rate. Following values are available: *25, 12, 8, 6, 4, 3, 2, 1*. Recording speed applies to entire Multiplexer. Depending on number of recording cameras the Multiplexer resources are equally divided between each camera.
- (4) **ALARM RECORD DWELL:** Time defined in seconds describing the alarm duration. This setting allows to record in alarm mode for longer periods of time than the duration of alarm event;

DEVICE MENU

- (4) **RECORD QUALITY:** This option defines the recording image compression level along with the recording quality level. 4 quality levels are available: *LOW*, *MEDIUM*, *HIGH*, *BEST*. The total duration of recording time for specific HDD depends on recording quality settings. Information concerning recording time might be obtained from *DVRcalc* our freeware software available as well on CD and Novus web site.
- (5) **MOTION EVENT MIGRATION:** This option allows adding motion detection events to the Event List. This setting has no influence on motion detection itself. It is only Event list operating rule.

NOTICE: Event List can store only latest 64 events for each HDD. You should set **MOTION EVENT MIGRATION** as **OFF** to store more important logs (e.g. power off) for longer time. In other case last 64 motion detection logs will replace more important events.

eng

4.4 Alarm setup

ALARM SETUP	
[BUZZER]	
BUZZER DWELL	1SEC
VIDEO LOSS ALARM	ON
MOTION ALARM	ON
EXTERNAL ALARM	OFF
[RELAY]	
VIDEO LOSS ALARM	OFF
MOTION ALARM	ON
EXTERNAL ALARM	ON
EXTERNAL SENSOR SETUP	
ALARM DISPLAY MODE	OFF
EXIT	

In **ALARM SETUP** menu following settings can be adjusted:

Buzzer settings:

- (1) **BUZZER DWELL:** This option is used to select buzzer dwell time after alarm detection
- (2) **VIDEO LOSS ALARM:** If this option is set to *ON*, buzzer will be turned on in case of video loss
- (3) **MOTION ALARM:** If this option is set to *ON*, buzzer will be turned on in case of motion detection
- (4) **EXTERNAL ALARM:** If this option is set to *ON*, buzzer will be turned on in case of external alarm

Relay settings:

- (1) **VIDEO LOSS ALARM:** If this option is set to *ON*, relay will be activated in case of video loss.
- (2) **MOTION ALARM:** If this option is set to *ON*, relay will be activated in case of motion detection
- (3) **EXTERNAL ALARM:** If this option is set to *ON*, relay will be activated in case of external alarm

EXTERNAL SENSOR SETUP: This option is used to configure alarm inputs. Each input can be set up as a normally opened, normally closed and inactive

ALARM DISPLAY MODE: If this option is set to *ON*, fullscreen video will be displayed from channel where alarm was detected.

DEVICE MENU

4.5 Schedule record

SCHEDULE RECORD menu represents various recording modes in different time during the day. Schedule recording can be set accurate to one hour. It is possible to set only one schedule recording that will be valid every day.

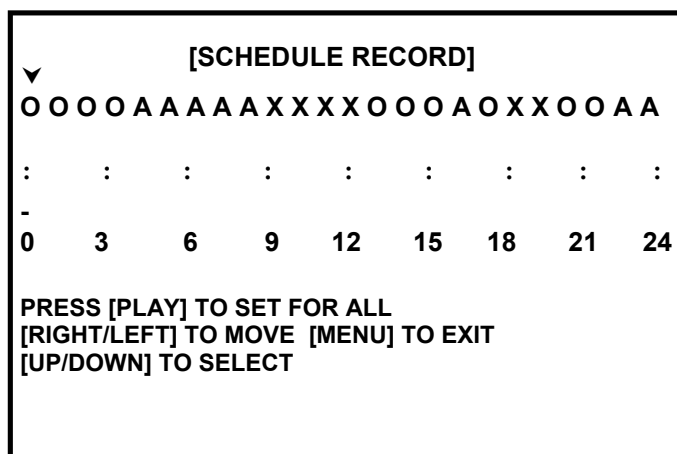

Letters represent recording modes valid for given hour.

O - this option is used for continuous recording speed accordingly to values set in *RECORD* menu in option *NORMAL RECORD FPS*, and in alarm recording mode (motion detection and external alarms) with speed set in *ALARM RECORD FPS* menu.

A - this means that recording process will occur only in the event of alarm (motion detection and external alarms) with speed set in *RECORD* in *ALARM RECORD FPS* menu

X - this means that during specified hour the recording process will not occur.

Time line indicators are placed below the letters line. In the example above continuous recording will be run during following hours 0-1; 3-4; 6-18 i 20-22. During this hours 1-2; 4-6 i 22-0 only alarm recording will take effect (external alarms and motion detection)

To change whole schedule configuration press *PLAY*. Pressing *PLAY* will result in changing all letters into "O", "A", "X".

4.6 Event List

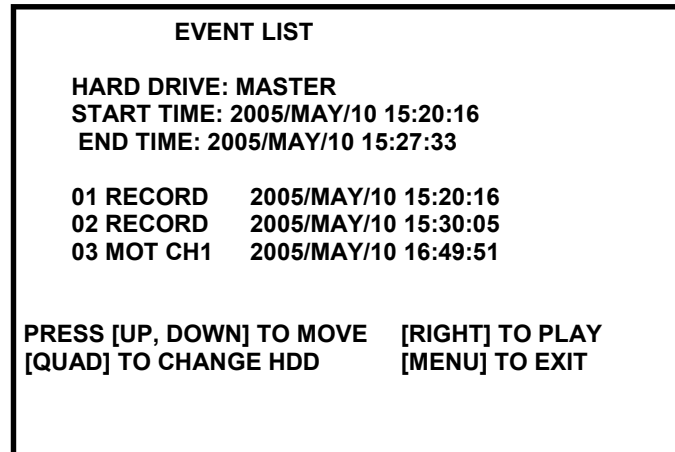

eng

When **EVENT LIST** is entered system history is available. The system registry stores events recorded from the time of the last HDD formatting. The events are divided according to the time of occurrence. The newest events are displayed as first. In the case when there are more events then can be displayed on one page additional events are displayed on following system registry pages.

Information is divided in columns;

The first column contains event number, the second - event date, the third - event time, the fourth - the event camera number, (-- this sign means that selected event concerns entire system).

In the fifth column specific shortcut describing event type is placed:

- *MOT CH1* motion detection activation on channel 1
- *RECORD* recording initiation
- *ALM CH1* alarm on the alarm input on channel 1
- *POWER* system reboot due to power failure

In the middle of the screen there is info which HDD (MASTER or SLAVE) Event list concerns. Pressing *QUAD* toggles between HDD's.

NOTICE: Event List can store only latest 64 events for each HDD. You should set *MOTION EVENT MIGRATION* as *OFF* to store more important logs (e.g. power off) for longer time. In other case last 64 motion detection logs will replace more important events.

DEVICE MENU

4.7 HDD Management

[HDD MANAGEMENT]	
→OVERWRITE ENABLE	NO
HDD FULL WARNING	20 %
MASTER HDD CAPACITY	76GB
MASTER HDD LEFT RATIO	73GB 97%
MASTER HDD FORMAT	
SLAVE HDD CAPACITY	N/A
SLAVE HDD LEFT RATIO	N/A
SLAVE HDD FORMAT	
EXIT	
PRESS [UP/DOWN] TO MOVE [MENU] TO EXIT [RIGHT/LEFT] TO SELECT	

The **HDD MANAGEMENT** menu is used to define following HDD settings:

- (1) **OVERWRITE MODE:** This option is used to select recording mode on HDD. If this option is set to **YES** the recording process will be „repeated”. That means that if all HDD capacity reserved for recording has been already used the system will start overwriting data previously stored on that HDD (starting from the point of the oldest recording). Previously stored data will be lost;

If this option is set to **NO** the system will stop the recording process when all available HDD capacity is used. “Disk Full” system notification will appear on the screen in the event of low HDD capacity left for recording;
- (2) **HDD FULL WARNING:** This option defines when the “Disk Full” system sound notification should appear. This setting is expressed in percentage. In the example shown above the buzzer will be turned on when disk free space will drop to 20%. It will be turned on again when only 5% of free space will be left. If overwriting option is active this menu line does not appear in the menu list;
- (3) **MASTER HDD CAPACITY:** Master HDD capacity information is expressed in GB;
- (4) **MASTER HDD LEFT RATIO:** available free space on MASTER HDD, information expressed in GB and %;
- (5) **MASTER HDD FORMAT:** When this option is selected and **ENTER** button is pressed all data from MASTER HDD will be erased. When option **FORMAT** is selected the system will ask for HDD formatting password. Password is 4 digits long (see chapter 4.1)

- (6) **SLAVE HDD CAPACITY:** Slave HDD capacity information expressed in GB;
- (7) **SLAVE HDD LEFT RATIO:** available free space on SLAVE HDD, information expressed in GB and %;
- (8) **SLAVE HDD FORMAT:** When this option is selected and *ENTER* button is pressed all data from SLAVE HDD will be erased. When option *FORMAT* is selected the system will ask for HDD formatting password. Password is 4 digits long (see chapter 4.1)

4.8. Network setup (only for NV-DVR1004NET)

eng

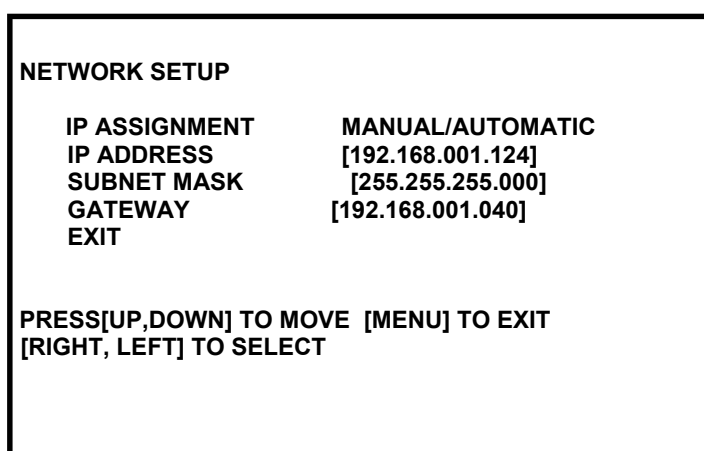

The **NETWORK SETUP** menu is used to define following HDD settings:

- (1) **IP ASSIGNMENT:** manual and automatic (via DHCP) IP assignment can be selected in this option
- (2) **IP ADDRESS:** in this option IP address can be selected
- (3) **SUBNET MASK:** in this option subnet mask can be selected
- (4) **GATEWAY:** in this option gateway can be selected

DEVICE MENU

4.9 Default setup.

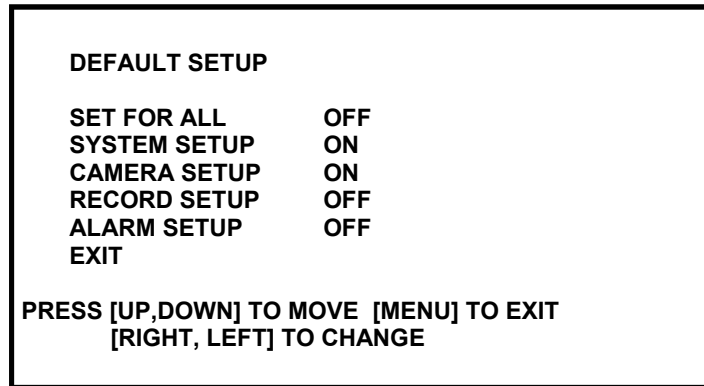

The **DEFAULT SETUP** menu is used to define which settings should be restored to factory default setup.

- (1) **SET FOR ALL:** setting this option causes changing all options.
- (2) **SYSTEM SETUP:** If this option is set to *ON*, system settings will be restored to default
- (3) **CAMERA SETUP:** If this option is set to *ON*, camera settings will be restored to default
- (4) **RECORD SETUP:** If this option is set to *ON*, record settings will be restored to default
- (5) **ALARM SETUP:** If this option is set to *ON*, alarm settings will be restored to default

In order to restore selected settings, exit menu and confirm overwriting.

5. RECORD SETUP

NV-DVR04 and NV-DVR04NET Multiplexers can automatically restore recording mode after rebooting and after exiting menu.

To stop recording press **STOP** ■. To activate recording ● button should be pressed.

Inscription **REC** is displayed when recording is active. Following letters describe recording mode:

[**M**] - multiplexer, [**Q**] - quad. In right upper corner there is recording speed information displayed.

Please notice that only active channels are recorded.

Current recording mode valid for each channel is displayed in the centre of the screen.

Notice: Available recording mode for each channel and for each hour are set in *SCHEDULE RECORD* menu.

PLAYBACK

6. PLAYBACK

Digital Multiplexers NV-DVR1004 and NV-DVR1004NET allows to find desired recordings in two ways. First search option can be done by inputting specified time and date. Second search option is possible by viewing the event registry and playback of recordings related to the selected event. Because devices operate as a simplex, to start playback recording must be turned off before.

In order to display playback menu **PLAY ►** button should be pressed.

eng

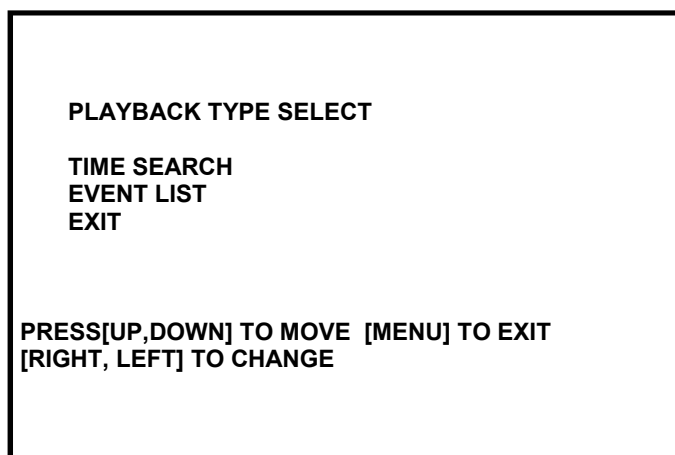

6.1 Time Search

When this option is selected date and time menu will appear on the screen allowing to playback specified data. Additionally available recording range information will appear.

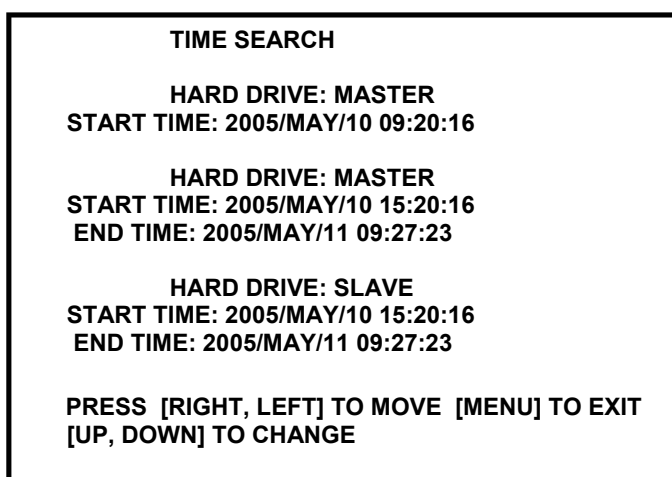

Information may depends on the number of installed HDDs or recording position on HDD and recording mode (overwrite).

To toggle between HDD's contents press *ENTER* button.

TIME SEARCH

HARD DRIVE: MASTER
START TIME: 2005/MAY/10 09:20:16

HARD DRIVE: MASTER
START TIME: 2005/MAY/10 15:20:16
END TIME: 2005/MAY/11 09:27:23

HARD DRIVE: SLAVE
START TIME: 2005/MAY/10 15:20:16
END TIME: 2005/MAY/11 09:27:23

PRESS [RIGHT, LEFT] TO MOVE [MENU] TO EXIT
[UP, DOWN] TO CHANGE

eng

To start playback recordings from specific time selecting proper HDD (using *QUAD*) button is required (if there are two HDD's). Then desired date and time should be set using cursor buttons. Playback starts after pressing *PLAY* button.

Default playback display is quad mode.

If played data was recorded in MUX mode there is channel selection and full screen display mode available.

During playback all playback control buttons are available (see description in chapter 3)

6.2 Searching Recorded Data From The Event List.

When this option is selected Event list will appear on the screen allowing to playback specified data related to system events.

To change HDD press *QUAD*. Desired event should be selected using cursor buttons ▲▼. Playback starts after pressing right cursor or *PLAY* button.

Event logs description are listed in chapter 4.6

Default playback display is quad mode.

If played data was recorded in MUX mode there is channel selection and full screen display possible.

During playback all playback control buttons are available (see description in chapter 3)

BACKUP

7. BACKUP

7.1. HDD backup on PC.

PC Viewer software allows to review and backup recordings from swappable HDD on PC.

eng

Detailed information is included in the manual of PC Viewer. PC Viewer software and manuals are included on CD.

7.2. Compact Flash Backup (NV-DVR1004NET only)

Digital Multiplexer NV-DVR1004NET is equipped with an interface allowing to connect Compact Flash memory cards. The memory card input socket is placed on the front panel next to the HDD bay.

Notice: Novus company guarantees proper operation only with Transcend CF cards supplied in DVR package.

Notice: During backup process computer network connection is prohibited. It is advised to disconnect the device physically from the net for the duration of backup process if there is a risk of incoming net connection.

Notice: Backup can be proceeded only in playback mode. Because device operates as a simplex, take into consideration that during backup process recording mode is unavailable, possible.

Notice: Recordings proceeded in QUAD mode can be backup only as a “quad pictures”. Only recordings proceeded in MUX mode allow selecting each channel.

The memory card should be inserted with caution to prevent the memory card socket from being damaged. The memory card should be inserted only in one way - the sticker with company logo and capacity should be faced left.



7.2.1 Single Image Backup

Insert the memory card inside card slot before starting the backup process.

If memory card is inserted into the device a sign in the lower left corner is displayed.

To backup single image in JPEG file, the playback of desired data must be run then selected camera must be displayed in full screen mode and finally the image must be frozen (pause button) in desired place. Using **II▶** and **◀II** buttons allows to select exact desired images. When desired image is selected press **COPY** button. Following message **CF CARD TESTING PLEASE WAIT** will be displayed. After short time message **SAVE OK** will appear. Additionally on the bottom of the screen memory card capacity information will appear. For example information **23MB / 121M 81%** means that currently 81% is free from the total available of 121MB. When the backup process is completed user can select next image or finish backup simply by taking out the memory card (message **CF CARD REMOVED** will appear on the screen).

eng

7.2.2 AVI Backup

Insert the memory card inside card slot before starting the backup process.

If memory card is inserted into device in the lower left corner sign CF is displayed.

To backup a video sequence in the AVI format playback of desired data must be run and selected camera must be displayed in full screen mode. Finally, select the desired backup time and press button **COPY**.

After short time message **BACKUP TO CF CARD AVI FILE** will appear. Additionally on the bottom of the screen below **CF** sign **AVI** sign will appear. This means that backup process is currently running. During this backup process user may increase or decrease the playback speed.

To finish backup of selected data button **COPY** should be pressed again. The following message will appear on the screen:

CF CARD PROCESSING, PLEASE WAIT.....

During the backup process the memory card must remain in the memory card reader at all times.

Similar information appears automatically after each minute of backup.

In order to take out the memory card the following information must appear on the screen.

SAVE OK

When the backup process is completed, user can select next video sequence or finish backup simply by taking out the memory card (message **CF CARD REMOVED** will appear on the screen)

Notice: When video sequence that user wants to backup is longer then one minute the device will automatically divide the backup data into files of duration time of 1 minute (size 2-3 MB).

If backup failed message **SAVE FAIL PLEASE CHECK CF CARD** will be displayed.

In such a case try to backup again after 30 sec. If another attempt fails, it means that CF card is damaged or incompatible.

ALARM INPUTS AND OUTPUTS CONNECTION

8. ALARM INPUTS AND OUTPUTS CONNECTION

Digital Multiplexers NV-DVR1004 and NV-DVR1004NET are equipped with 4 alarm inputs which allow to connect external devices. Output relay allows to control external devices e.g. sirens.

Do not exceed maximum current of 200mA.

When external alarm event occurs (any alarm input shorted with ground) Multiplexer will switch display to the quad mode, **ALM** sign will appear on the screen, alarm output relay will be closed and alarm event will be added to the Event list.

To automatically switch the device to alarm recording mode manual or schedule recording must be initiated. Junction for cable connection is equipped with handy, removable clamp junctions terminal. On this terminal also alarm output is placed. For detailed terminal description please view the image below.

PIN	FUNCTION
<i>ALARM IN 1</i>	Alarm input 1
<i>ALARM IN 2</i>	Alarm input 2
<i>ALARM IN 3</i>	Alarm input 3
<i>ALARM IN 4</i>	Alarm input 4
GND	Ground
<i>Relay N.C.</i>	Alarm output normally close
<i>Relay N.O.</i>	Alarm output normally open
COM	Alarm output common pin

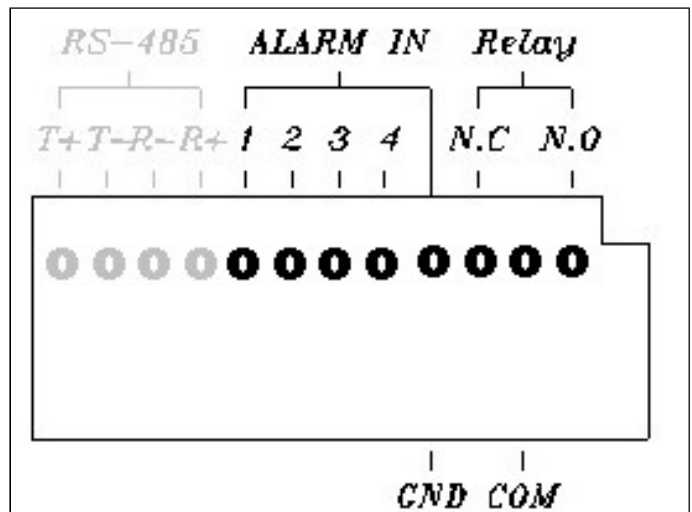

eng

SPEED DOME CAMERA - CONNECTION AND CONTROL

9. SPEED DOME CAMERA - CONNECTION AND CONTROL

Digital Multiplexer NV-DVR1004NET allows to control up to 4 speed dome cameras.

For camera control port RS-485 is used. Control lines are connected in a “daisy chain” way. Camera controlled by user by buttons placed on front panel or by utilizing net software. For proper operation each speed dome camera must have individual system address. Following rule should be applied: camera with address 1 is connected to video input nr 1, camera with address 2 connected to channel 2 and so on.

Control is done by Novus-C, Novus-C1, Novus-C2 or Pelco-D protocol.

Warning: All cameras in the system should have identical protocol and transmission speed 9600BPS (please view Speed Dome Camera Manuals).

Camera connection description applies to Novus camera connections. In order to connect cameras of other producers technical department should be contacted and user should familiarize himself with specific camera manual.

9.1 Novus Speed Dome Camera Connection

Speed Dome Camera control lines are connected in a “daisy chain” way with the use of twisted pair cable (UTP 5th class). The maximum length of line can not exceed 1200m.

The telemetry control signals are lead to junction with the symbol *RS-485*.

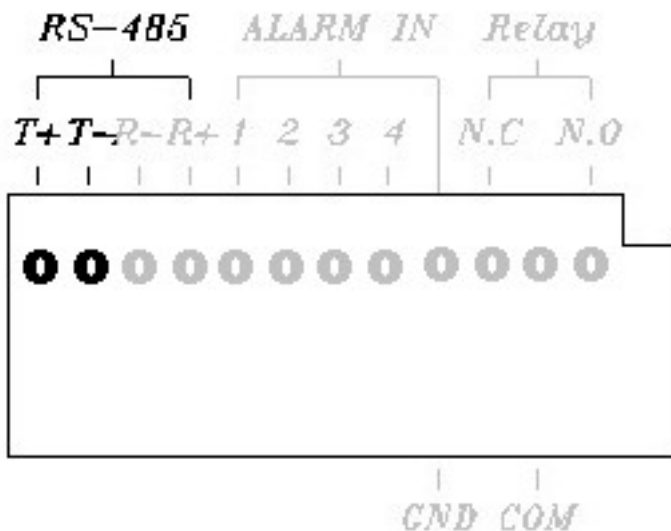

T+ Should be connected with Rx + / Tx+ in the camera
T- Should be connected with Rx - / Tx- in the camera

SPEED DOME CAMERA - CONNECTION AND CONTROL

Speed Dome camera connection

NV-DVR1004 or NV-DVR1004NET

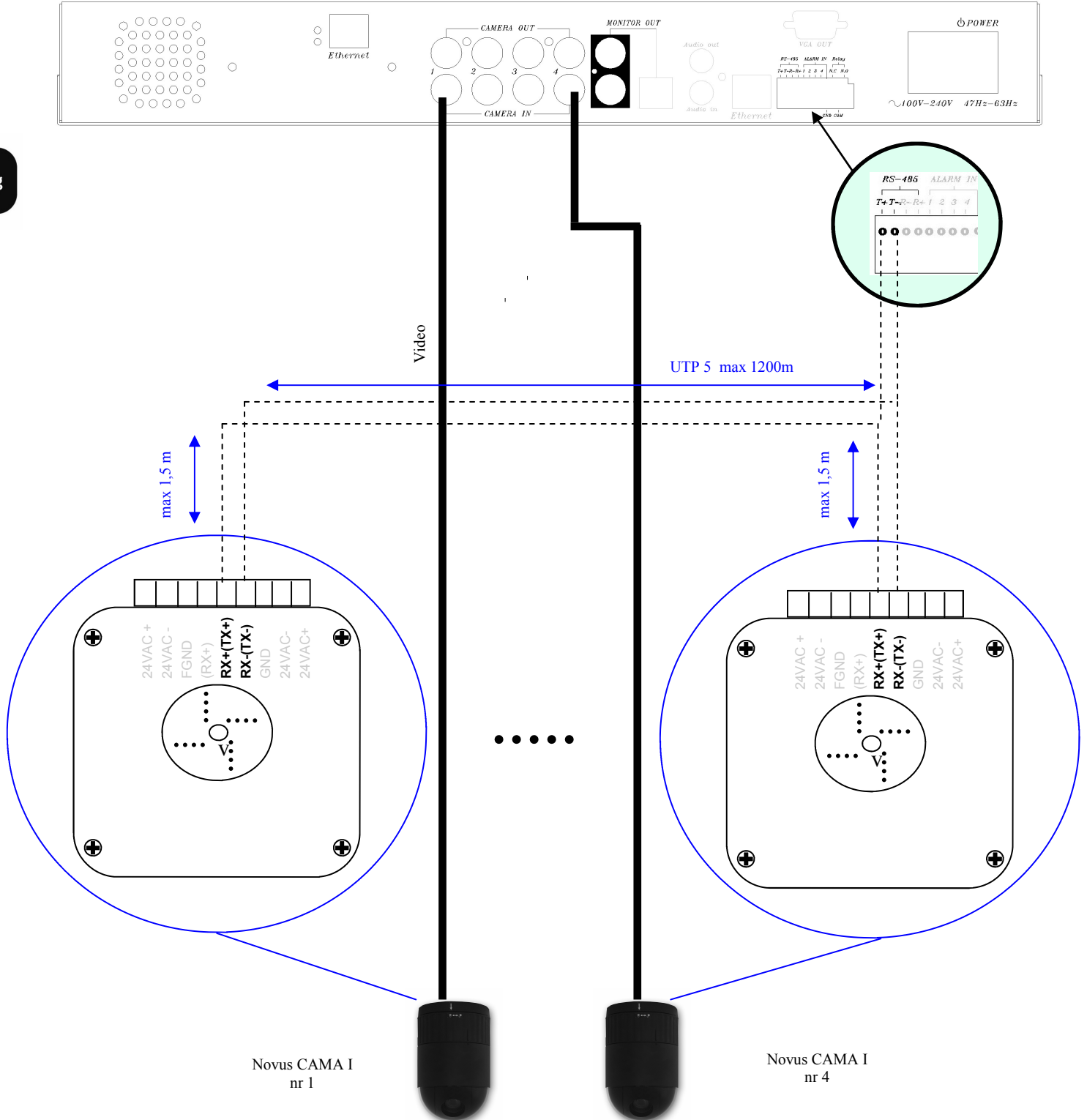







eng

SPEED DOME CAMERA - CONNECTION AND CONTROL

9.2 Camera Control

To enter camera control mode, specific camera should be selected. Set display to full screen mode and then press button 

In the upper right corner sign *PTZ* will appear informing that Multiplexer is set to Speed Dome Camera control mode and that some of buttons are now active as a Speed Dome control buttons.

Icon	Function
 <i>Rew Search</i>	Zoom out
 <i>Play</i>	Zoom in
	Tilt up
	Tilt down
	Pan right
	Pan left

eng

Control is done in a „step” way, which means that each button press will execute one step of particular function e.g. pan move.

When *MENU* button is pressed special PTZ menu will appear. Using this menu one of six camera pan and tilt levels may be defined. Each level represents how “long” the “step” is. The higher level number is, the bigger elementary movement is done.

Scan function is not available in cameras described above.

To exit PTZ menu *MENU* button should be pressed.

To exit PTZ camera control mode button  should be pressed. Sign *PTZ* will disappear from the screen and Multiplexer will return to normal working mode (buttons will activate standard functions)

```

PTZ SETUP

> PROTOCOL TYPE: NOVUS-C
UP-DOWN SPEED: 1
LEFT-RIGHT SPEED: 1
BAUDRATE: 9600

EXIT

PRESS[UP,DOWN] TO MOVE [MENU] TO EXIT
[RIGHT, LEFT] TO CHANGE
    
```

NETWORK CONNECTION FEATURE

10. NETWORK FUNCTION (NV-DVR1004NET ONLY)

Digital Multiplexer NV-DVR1004NET allows network connection option utilizing TCP/IP protocol. It is required to assign static IP address for the devices.

Warning: Operation conducted via net has direct influence on local operation. For example, change of display mode with the use of net will also change the display mode on Main monitor. This should be kept in mind. Net connection should be limited to the minimum especially if someone is monitoring area locally on Main monitor. This problem does not occur in the systems without local operators.

Warning: NOVUS company is not a distributor of server systems, routers, hubs, and other net devices which have influence on proper net working. Net user or network administrator is responsible for configuration propriety of mentioned devices .

10.1 Computer Hardware Requirements

Processor	Intel® Pentium® 1GHz (or higher)
RAM memory	Minimum 128MB
Internet browser	Internet Explorer 5.0 (or higher), with Java script set as active
Other devices required	Graphic Card, AGP x 4, 16MB
Operating System	Microsoft® Windows® 98 / ME / 2000 / XP™

NETWORK CONNECTION FEATURE

10.2 DVR Network Settings Configuration

To configure network settings, *IPInstaller* software should be used. This software is provided on CD included in the package.

To connect with Multiplexer application *IPInstaller.exe*, should be run. The device must be connected with the computer using of net cross cable which is also included in the package. The Multiplexer must be powered on. When system boot is finished **Search Device** button should be pressed.

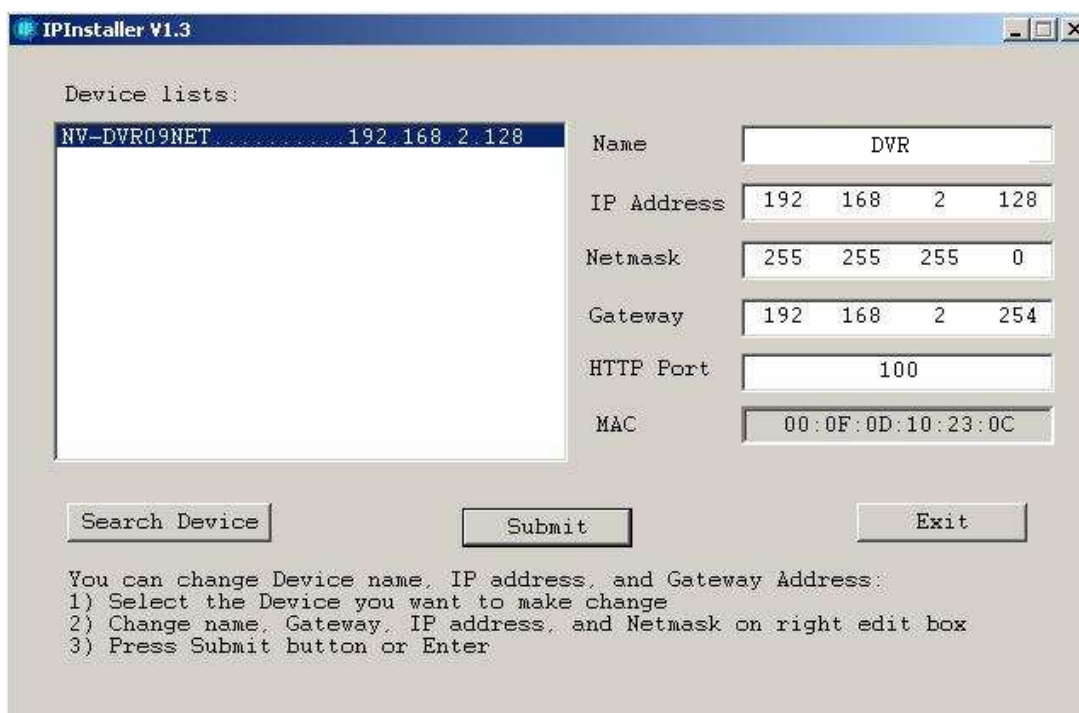

On the left side in the field *Device lists* the name of the device will appear along with its current IP address.

When this position is clicked on the right side net settings will appear:

- *IP Address*
- *Netmask*
- *Gateway*
- *HTTP Port*
- *MAC*

The above settings can be edited (except MAC) to adjust settings to meet specific net requirements.

When configuration settings is finished save changes clicking on **Submit**.

Net module reboot information will appear on the screen and after short time modified devices setting will appear.

Clicking **Exit** will exit application discarding changes.

NETWORK CONNECTION FEATURE

10.3 Initiating Connection

Microsoft Internet Explorer should be used for net connection. Multiplexer IP address should be input in the browser address bar (IP address can be acquired with the use of application *IPInstaller.exe*). If selected communication port is different than 80, after address space, colon and port number must be typed.

Example: for connection like in the example on previous page, following IP address should be input in the web browser address bar:

192.168.2.128 :100

During connection applet is downloaded from the device. This applet provides all Multiplexer network functions.

Network interface should appear after a while.

Depending on Windows security settings it might be necessary to accept unknown for system Active X format (click *Yes*)

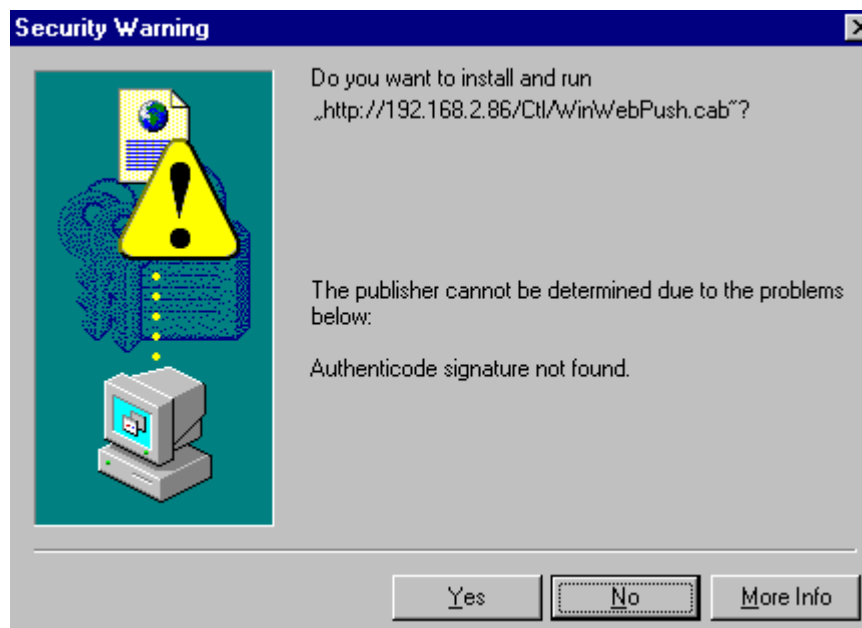

Click **Yes**

NETWORK CONNECTION FEATURE

10.4 User Interface View

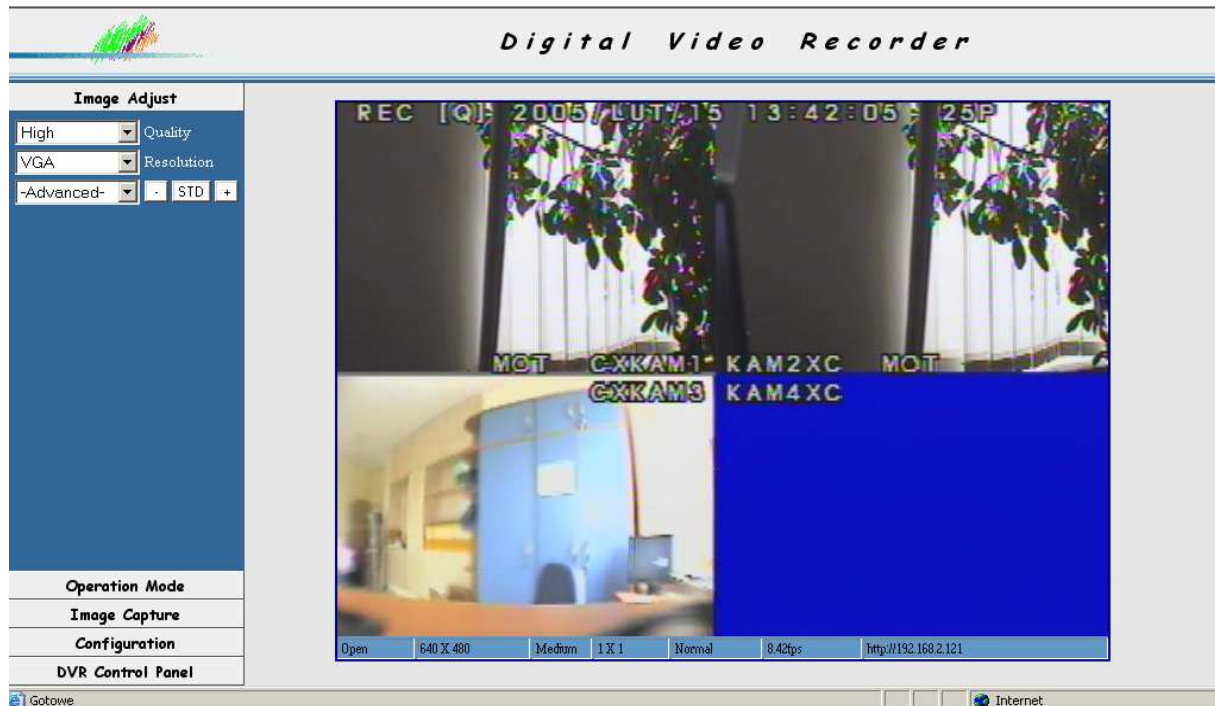

eng

Following description applies to network interface version 3.14.
The tabs on the left side of the screen allow to set various configuration and operation settings. Camera images fill the rest of the screen space. (default split screen to 4).

10.5 User Interface Function Description

10.5.1 Display Settings

In the tab **Image Adjust** user can adjust image display settings.

Quality option allows to select one of three levels of display quality: **High**, **Medium**, **Low**. Higher quality level settings makes lower displayed images refresh rate.

Resolution option allows to select one of three resolutions: **QCIF** - 176x144, **CIF** - 360x288, **VGA** - 640x480. The higher resolution settings are the lower displayed images refresh rate is.

Advanced option allows to select one of several image settings to correct the overall image appearance. Buttons + (increase), - (decrease), **STD** (restore default settings).

These settings are: **Brightness**, **Contrast**, **Saturation**, **Hue**, **Sharpness**.

NETWORK CONNECTION FEATURE

Current refresh rate and resolution is displayed on Status Bar.

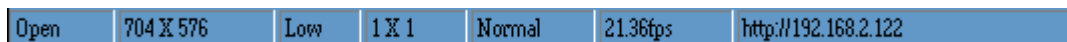

To display this Status Bar press right mouse button on camera image and select **Status Bar**.

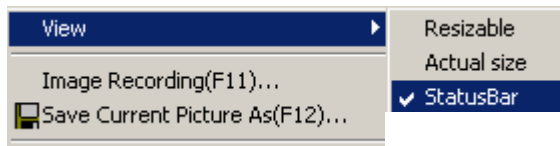

eng

Right-clicking on camera images brings on the menu that allows to define the video stream display mode in the web browser window. By default the image is „expanded” to entire available space irrespectively of real image resolution. **Actual size** option restores the real image display.

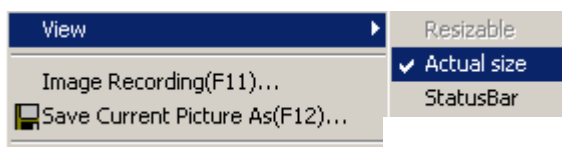

With default settings, when the web browser window is decreased, only a part of camera images is visible. depending on actual window size (the image size does not change). **Resizable** option should be marked if we desire to automatically adjust image size to fit in the window actual size.

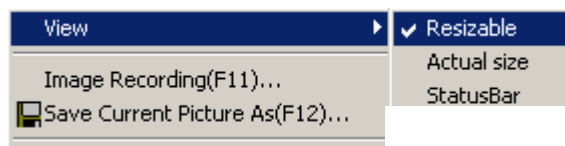

10.5.2 Transmission Speed

Operation Mode tab is used to adjust transmission speed to meet user expectations and network capabilities.

Continuous option allows for continuous transmission with maximum speed and refresh rate . However this will highly reduce the network capacity (around 4,5Mb/s is required).

If value number in seconds or milliseconds is input and **Periodic** option is marked the data will be sent periodically (with interval set in the window). As the refresh rate will drop the network free capacity will increase significantly.

NETWORK CONNECTION FEATURE

10.5.3 Saving images on PC

Image Capture tab is used to activate actual image capturing function of specified numbers of single images or video sequence from the playback/displayed stream. If camera images are displayed in quad mode or in freeze mode, that's exactly how it will be saved. The transmission speed and quality of saved files depends on settings described on previous pages.

To capture single currently displayed image F12 button should be pressed and saving path should be input/selected or **Snapshot** option should be selected.

To bring on Image Recording menu **Recording** option should be selected or F11 button should be pressed..

eng

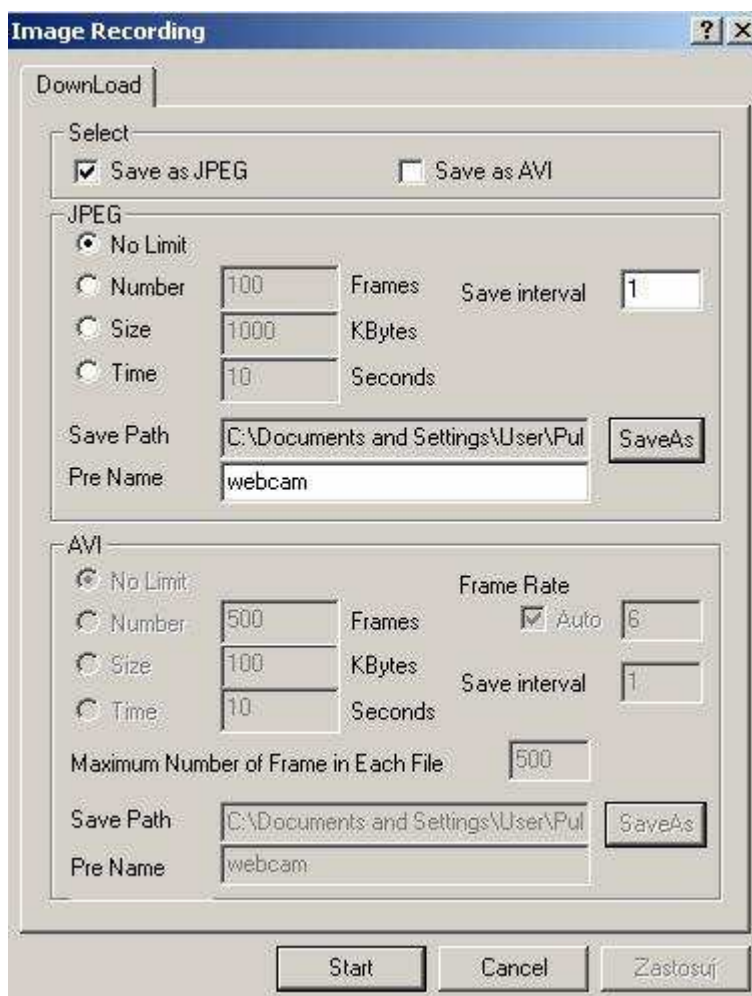

NETWORK CONNECTION FEATURE

In the field **Select** user must specify if captured images should be single frames (**JPEG**) or video sequences (**AVI**) or both .

- When saving JPEG files in the field **JPEG** exact number of saved files can be selected.
 - No Limit** option will save all files up to the point of manual stop (F11 button).
 - Number** option allows to specify the number of frames which will be saved.
 - Size** option allows to specify in kilobytes the total size of saved frames.
 - Time** option allows to specify in seconds the capturing time.

The image capturing begins at the moment when **Start** button is pressed.
 The files are stored in the folder selected in the field **Save Path**. The save path can be selected when **Save As** option is clicked.
Pre Name field is used to specify prefix which will be added to each file name.
Apply option is used to save settings.

- When saving AVI files in the field **AVI** the number of data which will be saved can be selected.
 - No Limit** option will save all files up to the point of manual stop (F11 button).
 - Number** option allows to specify the number of frames in video sequence.
 - Size** option allows to specify in kilobytes the total size of saved video sequence.
 - Time** option allows to specify in seconds the capturing time.

The field **Maximum Number of Frames in Each File** allows to specify the number of frames that files will consist of. Together with long capture time, this allows to divide video sequences into few smaller files.
 Video sequence capturing begins at the moment when **Start** button is pressed.
 The files are stored in the folder selected in the field **Save Path**. The save path can be selected when **Save As** option is clicked.
Pre Name field is used to specify prefix which will be added to each file name.
Apply option is used to save settings.

User is notified of current image capturing status. In the lower right corner yellow sign indicates capturing JPEG files and red sign indicates capturing AVI files.

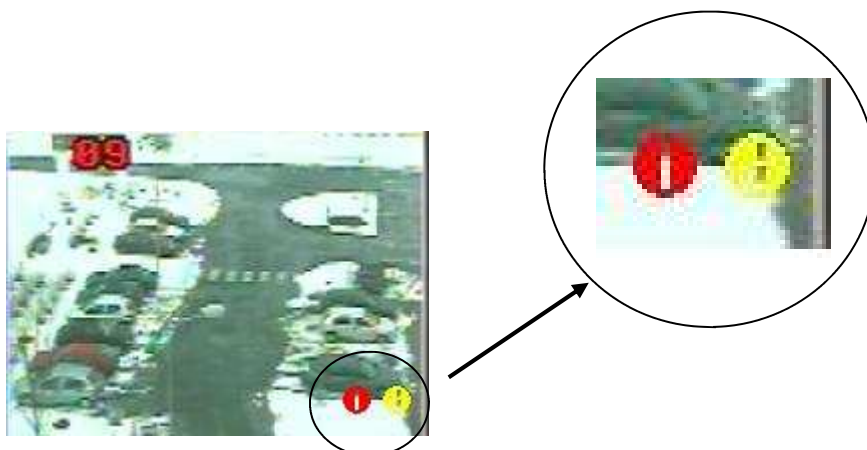

NETWORK CONNECTION FEATURE

10.5.4 Network Applet Configuration

Configuration tab is used for advanced applet settings such as user accounts administration, alarm function, etc.

10.5.4.1 Multiplexer Logs - system registry

View Log option allows to view system registry of the network interface. Multiplexer Logs lists information of type of the event, user IP and MAC address who made modifications and the exact time and date of the event.

DVR Logs <http://192.168.2.128:100>

Main Info	Appended Info	Operator IP	Operator MAC	Time
System Boot				2/2/2005 12:2
New client		192.168.2.185	00:90:27:43:D1:68	2/2/2005 12:5
Change quality	1	192.168.2.185	00:90:27:43:D1:68	2/2/2005 12:7
New client		192.168.2.68	00:40:F4:79:A7:F8	2/2/2005 12:15
Set Server Time	1	192.168.2.185	00:90:27:43:D1:68	2/2/2005 15:47
Change resolution	5	192.168.2.185	00:90:27:43:D1:68	2/2/2005 16:1
Change resolution	3	192.168.2.185	00:90:27:43:D1:68	2/2/2005 16:3

10.5.4.2 System Settings

System Setting option is used to retrieve following system information and to perform system modifications:

- **Version** - network interface version information
- **DVR Title** - device name, to enter new name input desired characters and press **Change**, to save
- **Device's time** - system time (network interface only)
- **Time zone** - time zone
- **NTP Server** - time synchronization server
- **Input new time, Synchronize with PC's time** - mark this option and click **Adjust** to synchronize system clock with PC clock
- **Language setting** - interface language selection
- **four channel DVR, nine channel DVR, sixteen channel DVR** - model selection with which connection is initiated (by default applet should detect automatically correct device type)
- **NTSC System, PAL System** - TV system selection in which Multiplexer will work
- **Reboot DVR** - network interface restart
- **Firmware update** - Network interface update (service function)

NETWORK CONNECTION FEATURE

10.5.4.3 User Accounts Management

User Management option is used to acquire following information and apply changes in the user accounts and network access passwords. There are two types of users: Administrator and Guest Administrator has full access to the system, Guest may only watch the displayed image in the display mode set by administrator or local operator.

- **User authorization required:** if **Yes** is selected **Set** is pressed the system will require authorization confirmation during network connections
- **Administrator** option allows to change the name and administrator password (default settings is **admin, admin**) New user name is input in **Username** field and new password is input in **Password** field. **Confirm** option is used to verify and confirm new settings. Modifications are confirmed by clicking on **Set & Change**
- **Add a user or change password** option is used to input new user name and password that will be added to the list when **Set & Change** is clicked. This field is also used to modify current user password when one of the existing users is selected from the list below.
- **Delete user**- select desired user from the list and click **Delete**; selected account will be erased. However **admin** account can not be erased.
- **Current user list**- the list of currently registered user accounts. From this list accounts can be selected for modification/deletion

10.5.4.4 Network Connection Parameters

Network Setting option is used to acquire following network settings information and connection methods:

- **LAN**- network settings, **Manually** - manual settings input (with the use of application IPInstaller), **Automatically by DHCP**- automatically set settings by DHCP server (if the network is configured in this method), in this mode when option **On** is marked in **Send email after DHCP** email will be sent each time address is given by server.
- **DNS Setting** - 3 server addresses DNS if they are required for connection
- **Port Setting** - HTTP port number used for transmission, default port 80, we advice changing the port address to any desired after consulting with network administrator.

To save current settings press **Save Setting**. To set settings as valid immediately **Reboot immediately** option should be marked and **Save Setting** must be clicked.

PPPoE tab is used to set transmission settings in PPPoE protocol.

WARNING: In the Network interface version 3.14 the PPPoE protocol and dynamic IP (**Dynamic DNS**) operation are inactive.

NETWORK CONNECTION FEATURE

10.5.4.5 Alarm Event Notification

Alarm and Motion Detection - this option is used to apply modification in the FTP server settings (image sending) and e-mails sending from alarm events.

- **Mail Setting (for sending images detected)** - option used to adjust e-mail notification settings:
 - Mail server** - mail server address used for sending e-mails.
 - Username** - the name of the user required when login to mail server (the e-mail account should be created earlier).
 - Password** - user password required during login to server mail
 - Sender email** - sender e-mail address (used for sending e-mails)
 - Receiver email** - the receiver e-mail address
 - Subject** - notification title (subject title)

Send mail when alarm and motion detected this option must be marked in order to send e-mail notification.

Save Setting to activate the settings this option should be clicked..

- **FTP Setting (for uploading images detected)** - option used to send alarm images to FTP server
 - FTP server** - image receiving FTP server address
 - Username** - username required while login to FTP server
 - Password** - user password required while login to FTP server
 - Port** - transmission port
 - Upload path** - user path, if program designated root folder is different then default the appropriate upload user path must be entered

Upload images when alarm and motion detected this option must be marked in order to send alarm image files

Save Setting to activate and save current settings modification click this option

NETWORK CONNECTION FEATURE

10.5.6 Multiplexer Remote Control

DVR Control Panel tab is used to activate or deactivate remote control interface. When the option *DVR Control Panel* is clicked special icon-key bar will be displayed on the bottom of the screen. This bar is used for remote control.



eng

As we can see above all of the front panel hard keys are displayed in this bar, except for *MENU* and *REC* buttons. The virtual keys function is identical with the real front panel hard keys described in previous chapters.

WARNING: If key-lock option is set as active then the virtual network interface keys are also deactivated.

ATTACHMENTS – INTERNAL HDD INSTALLING PROCEDURE

WARNING! Disconnect power supply cord from the device before HDD installation.

1. Unscrew 6 screws (marked with red arrows on the image below) and take off the top cover.



eng

2. View of the device without the top cover.



ATTACHMENT – INTERNAL HDD INSTALLING PROCEDURE

3. ... place HDD (previously properly preset with the HDD jumpers and connected to the power and data cables)

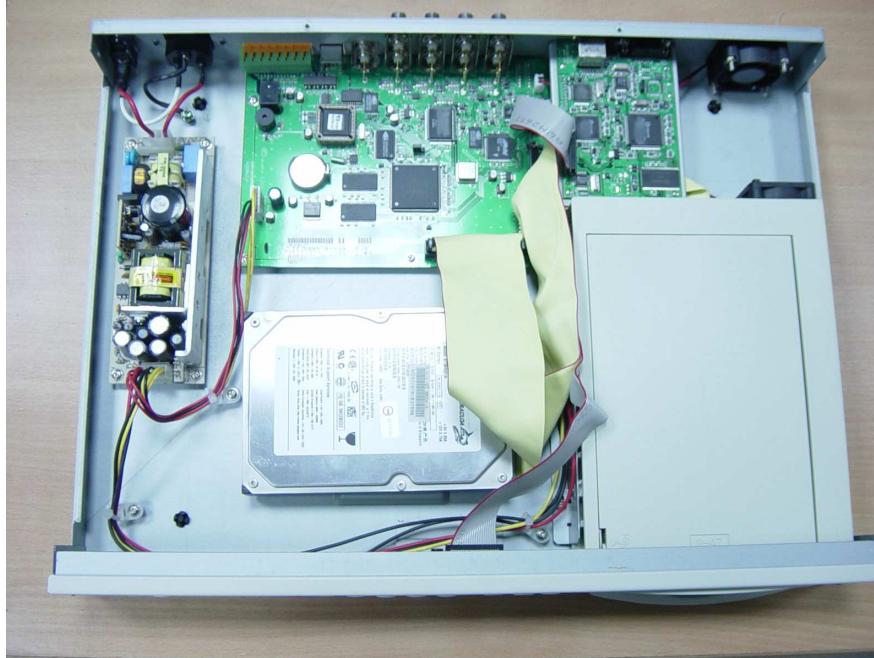

4.match the HDD mounting holes directly with mounting holes of the device then screw on 4 mounting screws.

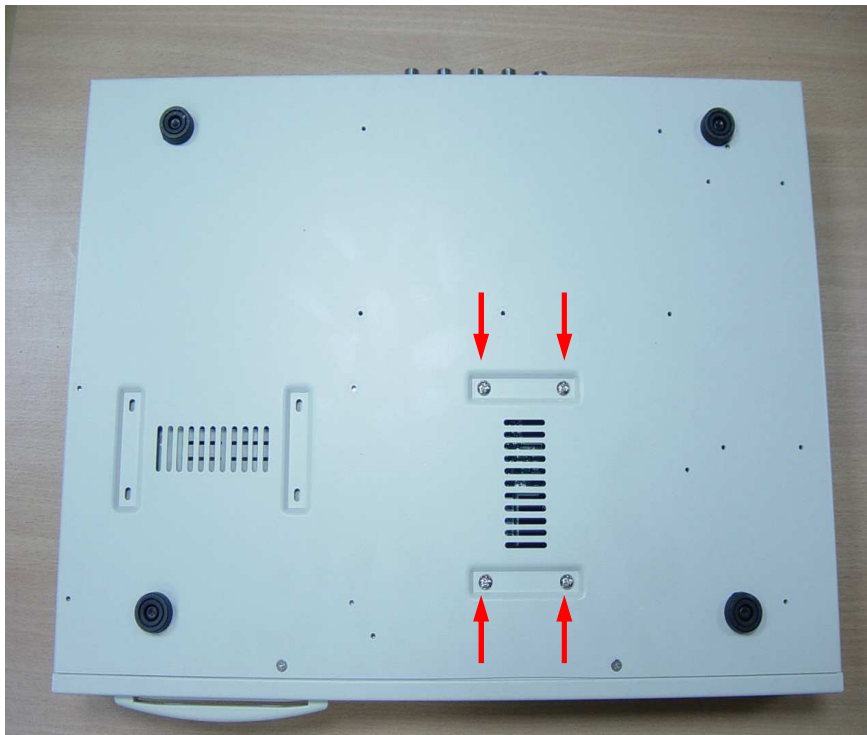

5. Put the cover back and screw it with 6 screws.

NOVUS[®]

NOVUS Security Sp. z o.o.

ul. Puławska 431, 02-801 Warszawa
tel.: (22) 546 0 700, fax: (22) 546 0 719
www.novuscctv.com