

***AVI201 / 202 / 203 / 212***

***Network Cameras***

***User's Manual***



Please read instructions thoroughly before operation and retain it for future reference.

The image shown above may differ from the actual product appearance.

# IMPORTANT SAFEGUARD



## CAUTION

### RISK OF ELECTRIC SHOCK



#### CAUTION:

To reduce the risk of electric shock, do not expose this apparatus to rain or moisture. Only operate this apparatus from the type of power source indicated on the label. The company shall not be liable for any damages arising out of any improper use, even if we have been advised of the possibility of such damages.

### Graphic Symbol Explanation



The lightning flash with arrowhead symbol, within an equilateral triangle, is intended to alert the user to the presence of uninsulated “dangerous voltage” within the product’s enclosure that may be of sufficient magnitude to constitute a risk of electric shock to persons.



This exclamation point within an equilateral triangle is intended to alert the user to the presence of important operating and maintenance (servicing) instructions in the literature accompanying the appliance.



All lead-free products offered by the company comply with the requirements of the European law on the Restriction of Hazardous Substances (RoHS) directive, which means our manufacture processes and products are strictly “lead-free” and without the hazardous substances cited in the directive.



The crossed-out wheeled bin mark symbolizes that within the European Union the product must be collected separately at the product end-of-life. This applies to your product and any peripherals marked with this symbol. Do not dispose of these products as unsorted municipal waste. Contact your local dealer for procedures for recycling this equipment.



This apparatus is manufactured to comply with the radio interference requirements.

### Disclaimer

We reserve the right to revise or remove any content in this manual at any time. We do not warrant or assume any legal liability or responsibility for the accuracy, completeness, or usefulness of this manual. The content of this manual is subject to change without notice.

### MPEG4 Licensing

THIS PRODUCT IS LICENSED UNDER THE MPEG-4 VISUAL PATENT PORTFOLIO LICENSE FOR THE PERSONAL AND NON-COMMERCIAL USE OF A CONSUMER FOR (i) ENCODING VIDEO IN COMPLIANCE WITH THE MPEG-4 VISUAL STANDARD (“MPEG-4 VIDEO”) AND/OR (ii) DECODING MPEG-4 VIDEO THAT WAS ENCODED BY A CONSUMER ENGAGED IN A PERSONAL AND NON-COMMERCIAL ACTIVITY AND/OR WAS OBTAINED FROM A VIDEO PROVIDER LICENSED BY MPEG LA TO PROVIDE MPEG-4 VIDEO. NO LICENSE IS GRANTED OR SHALL BE IMPLIED FOR ANY OTHER USE. ADDITIONAL INFORMATION INCLUDING THAT RELATING TO PROMOTIONAL INTERNAL AND COMMERCIAL USES AND LICENSING MAY BE OBTAINED FROM MPEG LA, LLC. SEE [HTTP://WWW.MPEGLA.COM](http://www.mpegla.com).

### Version

Firmware: 1012-1005-1005-1000  
Video Viewer AP Software: 0078

# TABLE OF CONTENTS

<b>1. PRODUCT OVERVIEW</b> .....	<b>1</b>
1.1 Description .....	1
1.2 Features .....	1
1.3 Package Contents .....	1
1.4 Specifications* .....	2
<b>2. HARDWARE OVERVIEW</b> .....	<b>3</b>
2.1 Rear Panel .....	3
2.2 Upper Side & Underside .....	3
<b>3. INSTALLATION</b> .....	<b>4</b>
3.1 Install the Hardware .....	4
3.2 Assign an IP address and Access the Camera.....	6
<b>4. VIDEO VIEWER BASIC OPERATION</b> .....	<b>7</b>
4.1 The Live View Page .....	7
4.2 Address Book .....	8
4.3 Emap.....	9
4.4 Manual Record.....	11
4.5 Playback .....	12
4.6 Snapshot.....	13
4.7 Information .....	13
<b>5. VIDEO VIEWER MISCELLANEOUS CONTROL PANEL</b> .....	<b>14</b>
5.1 Color Setting .....	15
5.2 Backup (For DVR only) .....	15
5.3 Record Setting .....	16
5.4 Server Setting .....	18
General .....	18
Log.....	19
Account.....	19
Online User.....	20
Trigger .....	21
Network.....	22
DDNS.....	23
SNTP .....	26
FTP.....	26
MAIL .....	27
Video.....	27
5.5 Tools.....	28
Firmware Upgrade .....	28
Language Selection .....	29
5.6 Status List.....	29
Record .....	29
Event.....	30
Backup (For DVR only) .....	31
Playback Screen.....	31
<b>6. IE WEB BROWSER</b> .....	<b>33</b>
6.1 Access the Camera from an IE Web Browser .....	33
6.2 Toolbar Display on the IE Web Browser .....	33
<b>7. QUICKTIME PLAYER</b> .....	<b>35</b>
<b>APPENDIX 1 RECORDING TIME TABLE</b> .....	<b>36</b>
<b>APPENDIX 2 USER LEVEL FOR REMOTE OPERATION</b> .....	<b>39</b>
<b>APPENDIX 3 DEFAULT VALUE</b> .....	<b>41</b>

# 1. PRODUCT OVERVIEW

## 1.1 Description

This camera series is a network-based digital surveillance device with a built-in web server for the purpose of remote monitoring and recording. It supports TCP/IP networking for live video transmission in the format of H.264, MPEG4 or MJPEG, and you can easily operate the camera via the web browser or the supplied video viewer AP software. Video surveillance over IP network infrastructure is available and easy from anywhere, at anytime.

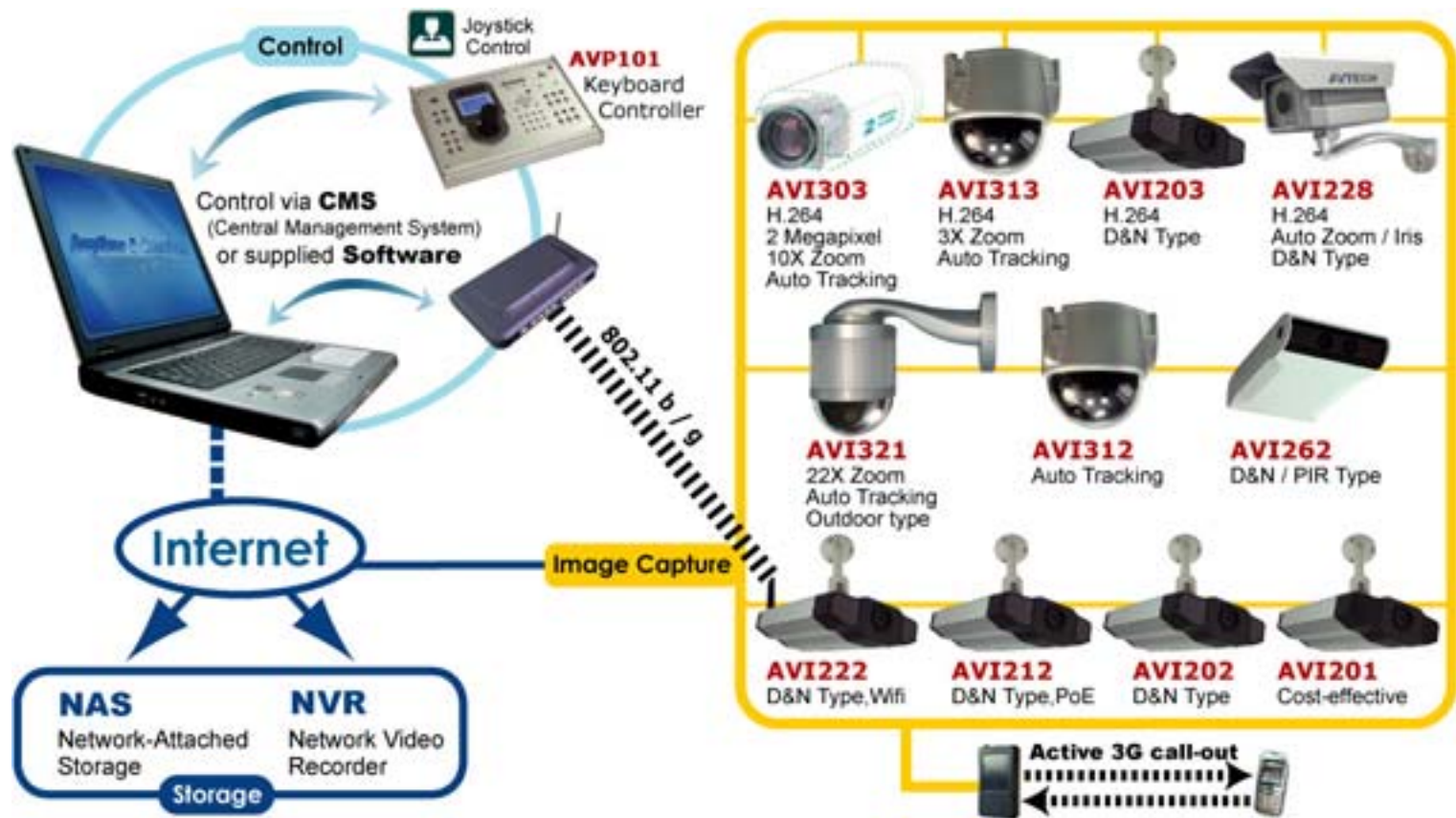

## 1.2 Features

- Low-latency video streaming for sharp and clear images
- Hybrid digital / analog video output
- Motion detection
- Complete IP surveillance system, such as the Central Management System (CMS) software, Network-Attached Storage (NAS), Network Video Recorder (NVR), etc.
- External microphone in / audio out for two-way voice communication (AVI202 / 203 / 212 only)
- Day/night functionality (AVI202 / 203 / 212 only)
- Alarm notification (AVI202 / 203 / 212 only)

## 1.3 Package Contents

<input type="checkbox"/> Network camera	<input type="checkbox"/> Quick user guide
<input type="checkbox"/> Adapter and power cord	<input type="checkbox"/> CD-ROM disc for user manual
<input type="checkbox"/> Bracket	<input type="checkbox"/> CD-ROM disc for <i>Video Viewer AP Software</i>
<input type="checkbox"/> RJ45 network cable	

## 1.4 Specifications\*

SPECIFICATIONS	AVI201	AVI202	AVI203	AVI212
<b>■ Network</b>				
LAN Port	YES			
LAN Speed	10/100 Based-T Ethernet			
Supported Protocols	DDNS, PPPoE, DHCP, NTP, SNTP, TCP/IP, ICMP, SMTP, FTP, HTTP, RTP, RTSP			
Frame Rate	NTSC:30, PAL:25			
Number of Online Users	10			
Security	Multiple user access levels with password			
Web management software	YES (Control up to 16 network cameras simultaneously)			
<b>■ Video / Audio</b>				
Video Compression	MPEG4 / MJPEG	H.264 / MPEG4 / MJPEG		MPEG4 / MJPEG
Video Remote Control	YES			
Video Adjustment	Brightness, Contrast, Saturation and Hue			
Audio Compression	NO	uLaw , 128kbps		
Audio Input	NO	Built-in Microphone, External Microphone Input		
Audio Output	NO	YES		
<b>■ Camera</b>				
Image Sensor	1/3.6" image sensor		1/3" CCD image sensor	1/3.6" image sensor
Pixels	738(H) x 480(V)		NTSC: 512(H) x 492(V) / PAL: 512(H) x 582(V)	738(H) x 480(V)
Lens	f3.6mm	f4.6mm	f3.6mm	f4.6mm
F-number	F2.0		F1.9	F2.0
Viewing Angle	80°	55.6°	80°	80°
Shutter Speed	1 / 60 (1/50) to 1 / 100,000 sec.			
IR LED	NO		YES	
Min Illumination	1 Lux / F2.0	1 Lux / F2.0; 0 Lux (10m IR ON)	0 Lux (11m IR ON)	1 Lux / F2.0; 0 Lux (10m IR ON)
Video Output	1.0 Vp-p. 75Ω			
BLC	AUTO			
White Balance	ATW			
<b>■ Others</b>				
Remote Control	YES			
Motion Detection	YES			
Alarm and event Notification	NO	Image upload over FTP and Email		
General I/O	NO	Alarm in x1		
Power	DC12V, 0.5A	DC12V, 1A		PoE (Power over Ethernet)
Operating Temperature	0~40°C			
Humidity	85%			
Minimum Web Browsing Requirements	<ul style="list-style-type: none"> <li>• Pentium 4 CPU 1.3 GHz or higher, or equivalent AMD</li> <li>• 256 MB RAM</li> <li>• AGP graphics card, Direct Draw, 32MB RAM</li> <li>• Windows XP, Windows 2000 Server, ME, 98, DirectX 9.0 or later</li> <li>• Internet Explorer 6.x or later</li> </ul>			
Dimensions (L x W x H)**	152.5 x 115.2 x 40.2 mm (6.00" x 4.54" x 1.58")			
Shipping Weight	812g (1.79 lbs) including mounting bracket and power supply			
Indoor / Outdoor Application	Indoor			

\* The specifications are subject to change without notice.

\*\* Dimensional tolerance: ± 5mm

- **Dimensions:** 152.5 (L) x 115.2 (W) x 40.2 (H) mm

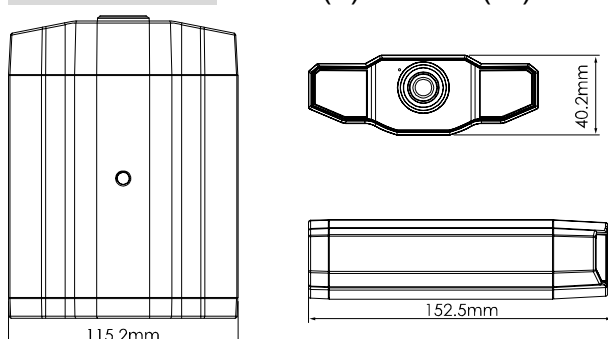

## 2. HARDWARE OVERVIEW

### 2.1 Rear Panel

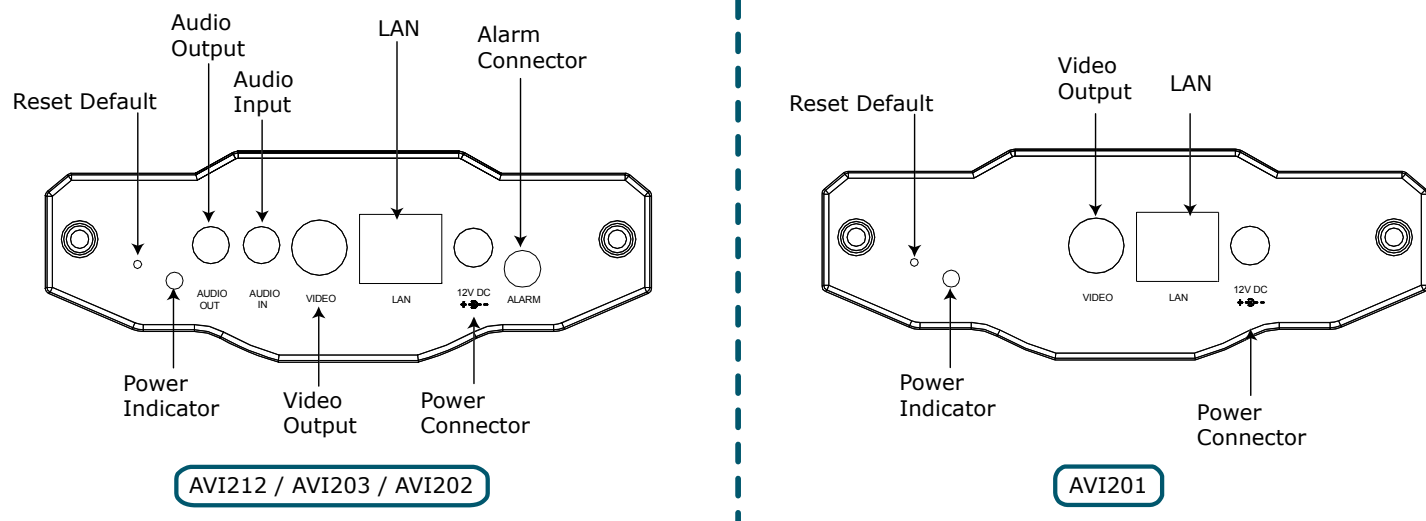

CONNECTOR / BUTTON	DESCRIPTION
Reset Default	This button is hidden in the pinhole. Press and hold the reset button until the network camera rebooted. This will reset all parameters, including the IP address to factory default settings.
Power Indicator	When the camera is power-supplied, this indicator will be on as red.
Audio Output (AVI202 / AVI203 / AVI212 only)	Support the connection to an audio device, such as a speaker, for voice transmission of the remote side.
Audio Input (AVI202 / AVI203 / AVI212 only)	Support the connection to an audio device, such as a microphone, for voice transmission of the local side.
Video Output	Connect to the video input connector of your monitor with a video cable (i.e. a RCA line with the BNC connector, or a coaxial line) for video output. * The video cable is optional.
LAN	Connect the camera to the network with the supplied RJ45 cable.
Power Connector	Connect the DC 12V adapter for power supply.
Alarm Connector (AVI202 / AVI203 / AVI212 only)	Support the connection to an alarm device for function scalability.

### 2.2 Upper Side & Underside

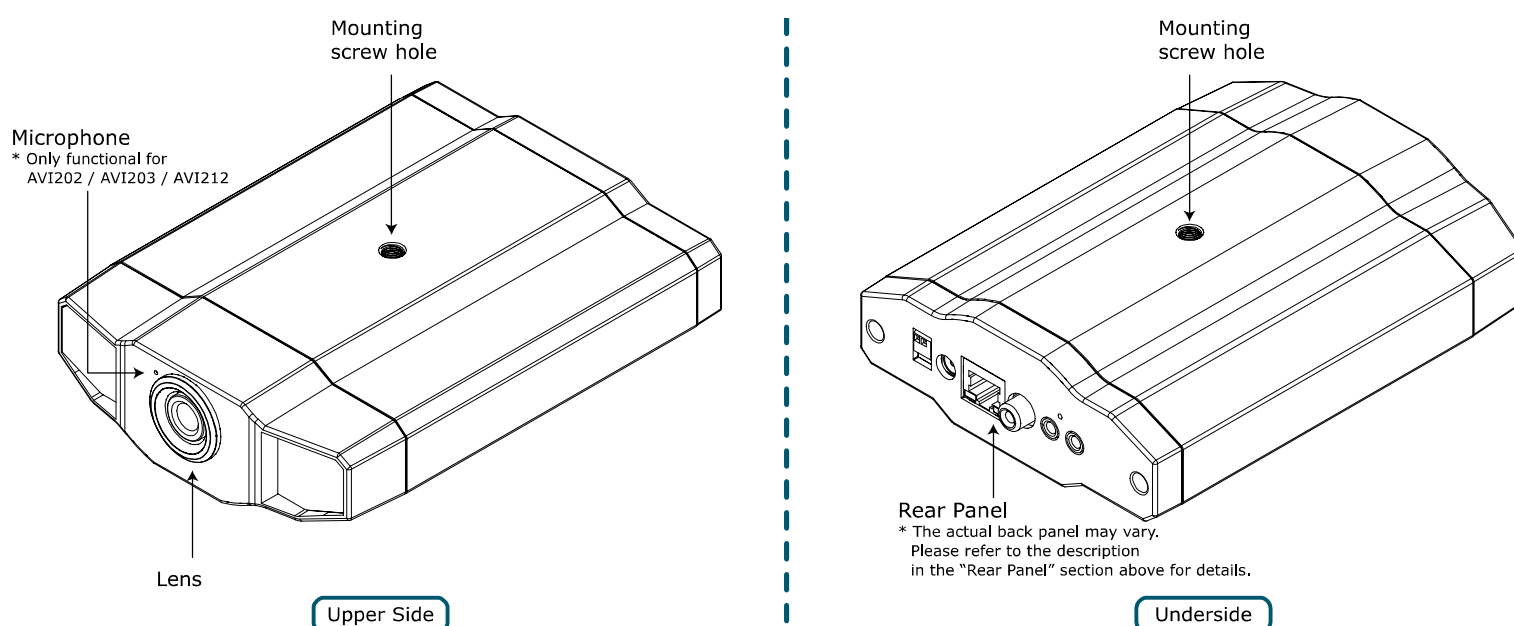

### 3. INSTALLATION

#### 3.1 Install the Hardware

This camera can be installed in two ways: ceiling-mounted and desktop. During the installation, please make sure the upper side of the camera is always facing up, as shown in Figure 1 below, regardless of which installation way you're using. This is to ensure the video output won't be up side down.

**Note:** The illustrations below are based on the ceiling-mounted installation.

**Note:** For the detailed cable connection, please refer to the section "2.1 Rear Panel" on Page 3.

Tool needed: Power drill x 1 (not supplied within the sales package)

1. Prepare all the parts needed for camera installation.  
 Find the network camera, bracket package, a bag of screws & wall plugs, and a cap supplied with the sales package, as shown in Figure 1.  
 Unpack the bracket package to find the bracket disassembled into three parts: the base, stem and joint lock.

**Figure 1: Parts needed for camera installation**

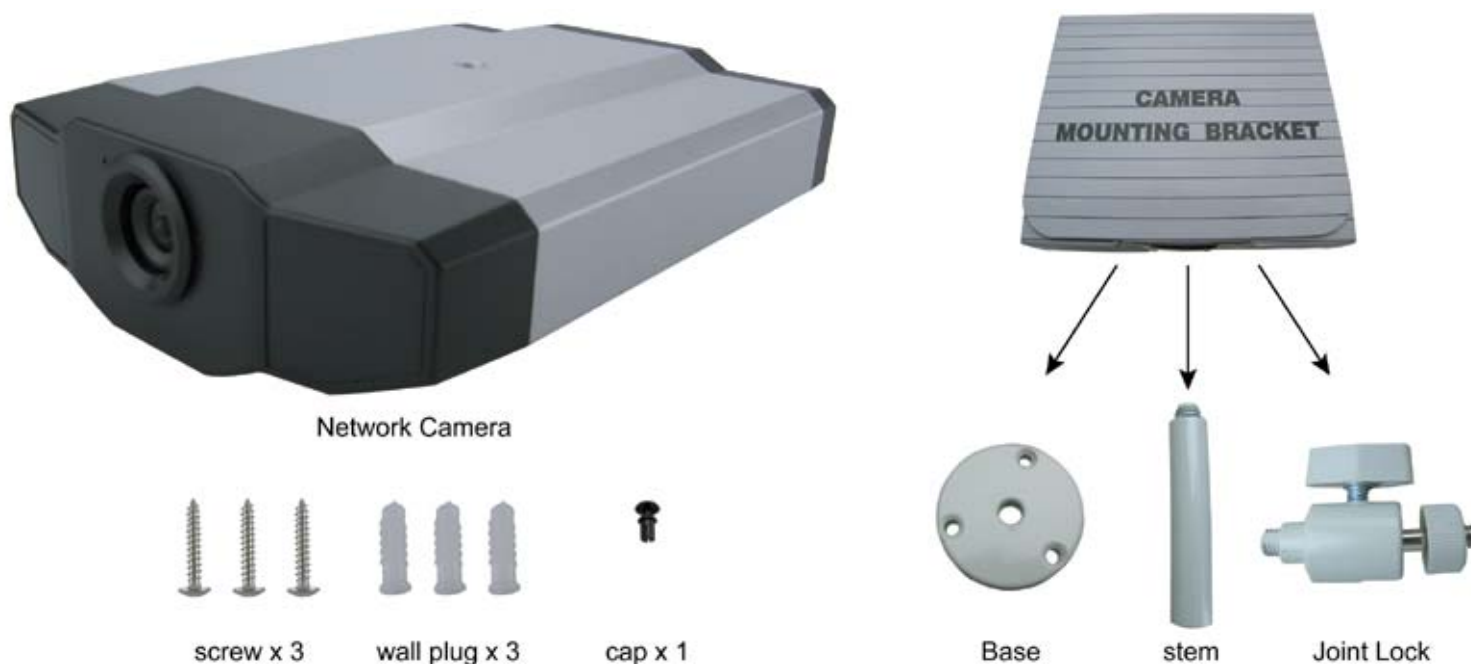

2. Fix the base of the bracket.  
 Fix the base of the bracket with the supplied 3 screws to the place you want to install by using a power drill.

**Figure 2: Screw the base to the ceiling**



3. Assemble the bracket:
  - a). Align the stem with the central hole of the base, and rotate it to secure, as shown in Figure 3.
  - b). Align the joint lock with the stem, and rotate it to secure, as shown in Figure 4.

**Figure 3: Connect the stem to the base**



**Figure 4: Connect the joint lock to the stem**

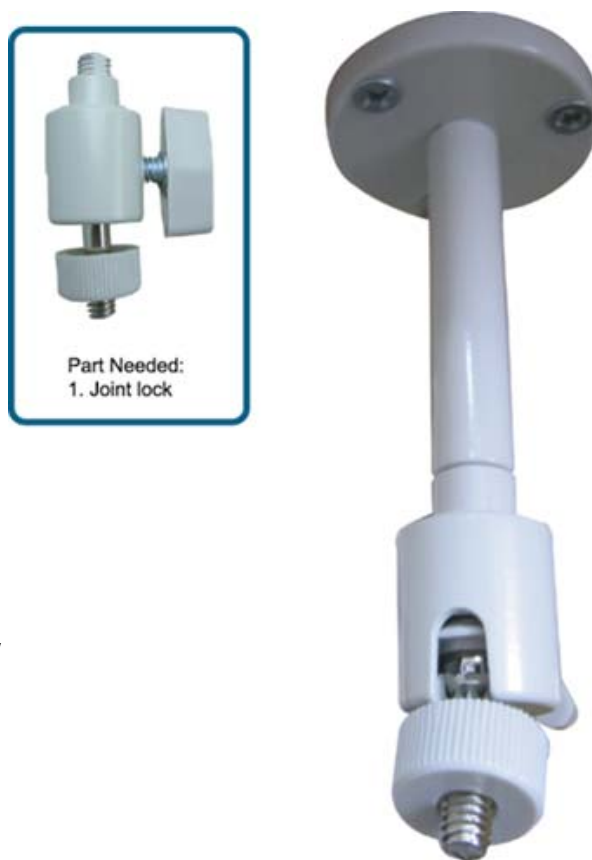

4. Connect the camera to the bracket.
 

*Ceiling-mounted:*  
With the upper side of the camera facing up, align the mounting screw hole on the upper side with the screw thread of the joint lock, and rotate the camera to secure, as shown in Figure 4.

*Desktop:*  
With the upper side of the camera facing up, align the mounting screw hole on the underside with the screw thread of the joint lock, and rotate the camera to secure.

**Figure 4: Connect the camera to the bracket**

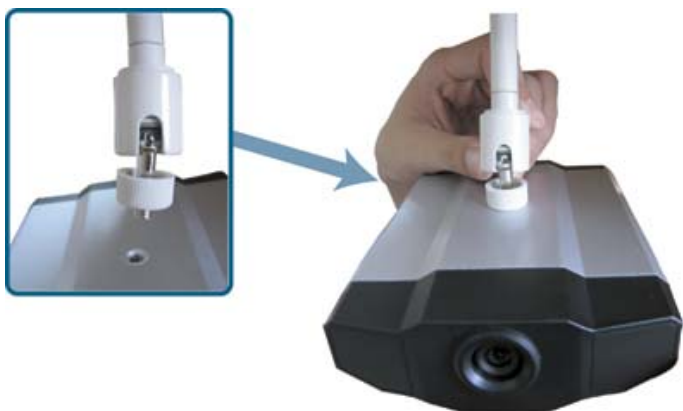

**Figure 5: Insert the cap to the camera**



5. Insert the cap to the other mounting screw hole of the camera.
 

*Ceiling-mounted:*  
Insert the cap to the mounting screw hole on the underside of the camera, as shown in Figure 5.

*Desktop:*  
Insert the cap to the mounting screw hole on the upper side of the camera.
6. Adjust the viewing angle of the camera, and fasten the joint lock to fix the angle. The installation is completed, as shown in Figure 6.

**Figure 6: Finish the installation**

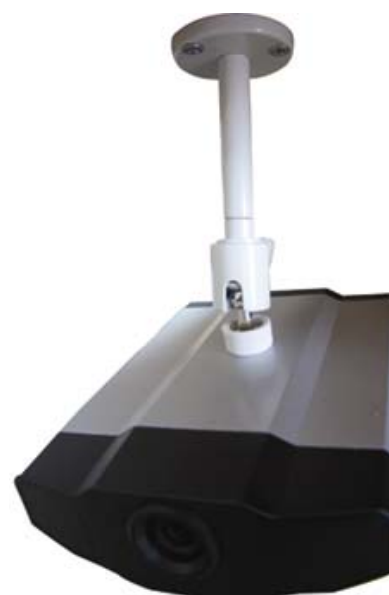









## 3.2 Assign an IP address and Access the Camera

### Step 1. Install the Software

Place the supplied Video Viewer AP software CD into your DVD- / CD-ROM drive. The installation process will automatically start. Follow the on-screen instructions to install the application programs. After installation, a “Video Viewer” shortcut icon will be shown on your PC desktop.

### Step 2. Connect the network camera to the LAN access via a RJ-45 network cable.

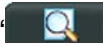
### Step 3. Search the available IP address to login

- Double-click  icon on your PC desktop to enter the Video Viewer control panel. By defaults, the “Address Book” () panel will be displayed on the right side of the Video Viewer control panel.
- Click  (Search) →  (Refresh) to search the available IP address(es). The found address(es) will be listed, and can be added into the address book by clicking  (Add into address book). For details, please see  (Search) on Page 9.
- Select the IP address you just added into the address book, and click  (Edit) to edit the settings.
- Double-click the IP address in the address book to log in.

---

**Note:** Your PC / laptop and DVR must be under the same domain to build an area network. Please change the IP address of your PC / laptop into 192.168.1.X (X can be the number between 1~255, except 10) to login. The default IP address of your DVR is **192.168.1.10**, and the default username as well as the password is **admin**.

---



---

**Note:** For detailed network settings under different network types (Static IP / PPPOE / DHCP), please refer to “Network” on Page 22 and “DDNS” on Page 23.

---



- If you cannot search any available IP address, please follow the instructions below.

### Step 4. Add the IP address and other network settings to login

- Double-click  icon on your PC desktop to enter the Video Viewer control panel. By defaults, the “Address Book” panel will be displayed on the right side of the Video Viewer control panel.

- The default network camera settings are as follows:

Item	Default Setting
IP Address	192.168.1.10
User Name	admin
Password	admin
Port Number	80

- Click  (Address Book) →  (Add) button to key in the IP address, user name, password, and port number of the network camera you intend to connect.

Item	Default Setting
IP Address	192.168.1.10
User Name	admin
Password	admin
Port Number	80









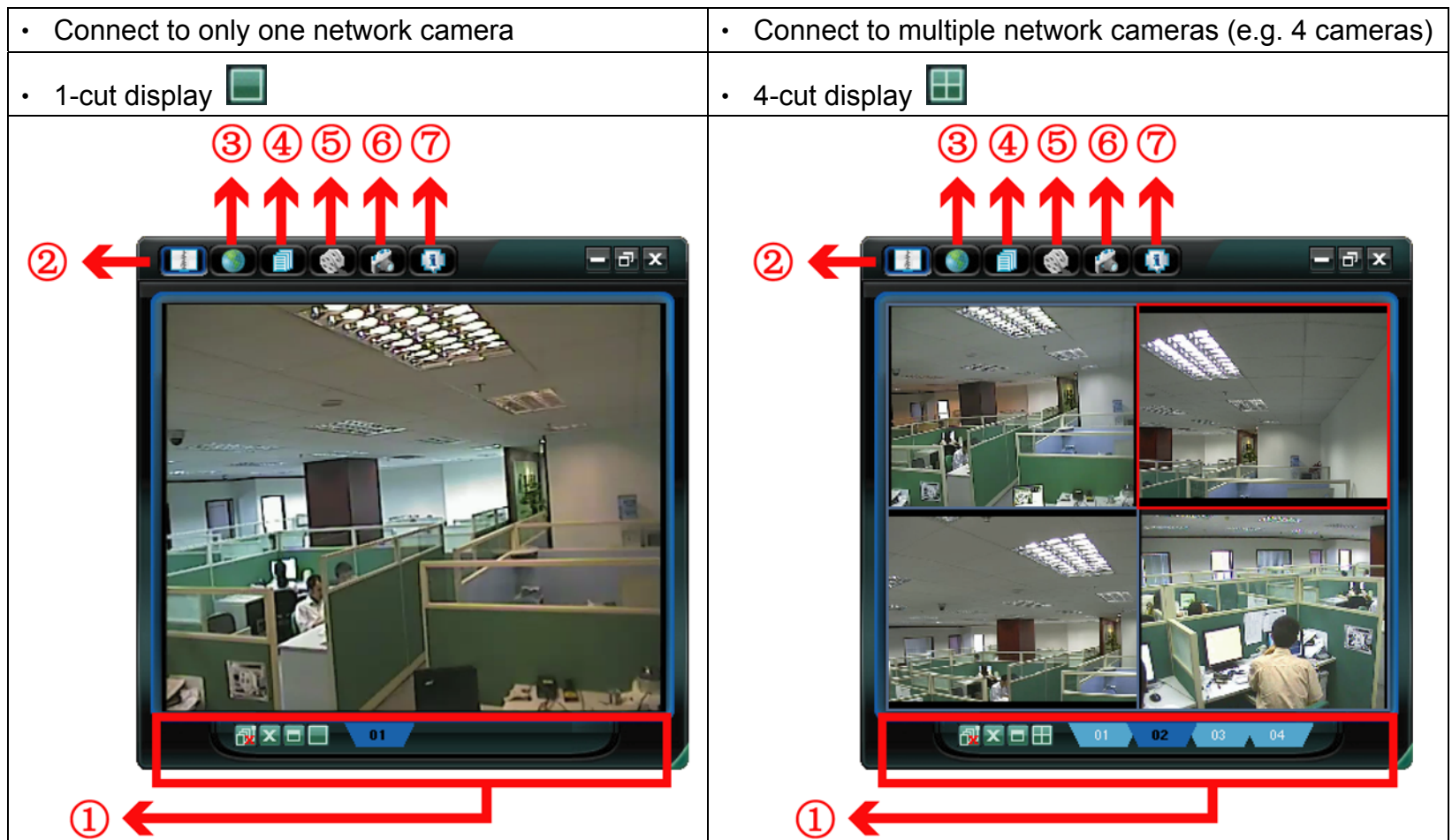

- Double-click the IP address you just added into the address book to log in.

## 4. VIDEO VIEWER BASIC OPERATION

### 4.1 The Live View Page

After setting up the network information, login user name and password, double-click  on the PC desktop to open and log into the Video Viewer control panel. You will see a screen similar to the following with 6 major sections:



NO.	Button	Function	Description
①		Image Display	To switch to another camera view if two or more network cameras are connected, click the corresponding blue tab. The camera title shown in the blue tab can be customized (For example, "01", "02", "03" and "04"). The default camera title is "Camera1". For detailed camera title setting, please refer to "General" on Page 18. The software can control up to 16 network cameras simultaneously.
		Scale	Click to view the images in the 1-cut, 4-cut, 9-cut and 16-cut mode.
		Full Screen	Click to view the images in the full screen mode. To exit the full screen mode, press "Esc" key on the keyboard of the PC.
		Close	Click to close the current image display view. If the image display view is closed, you will be logged out automatically.
		Close All	Click to close all the current image display view. If the image display view is closed, you will be logged out automatically.
②		Address Book	Click to show the predefined IP address(es). You can add, remove or search the IP address to log in the network camera remotely.
③		Emap	Click it to show the emap screen in which you can see where the connected cameras are and watch the live display of every camera.
④		Miscellaneous Control	Click to show the main operation functions: audio volume control, color setting, backup, record setting, server setting, upgrade, and find status log list.
⑤		Record / Stop Record	Click to start / stop the manual recording.
⑥		Snapshot	Click to take a snapshot of the current view. The snapshot will be saved in the path you specified in "5.3 Record Setting" on Page 16.
□		Information	Click to show the current network connection details.

## 4.2 Address Book

This view is displayed when the Video Viewer is activated for you to log in / out the network camera from the current address list, or search the available IP address as follows:

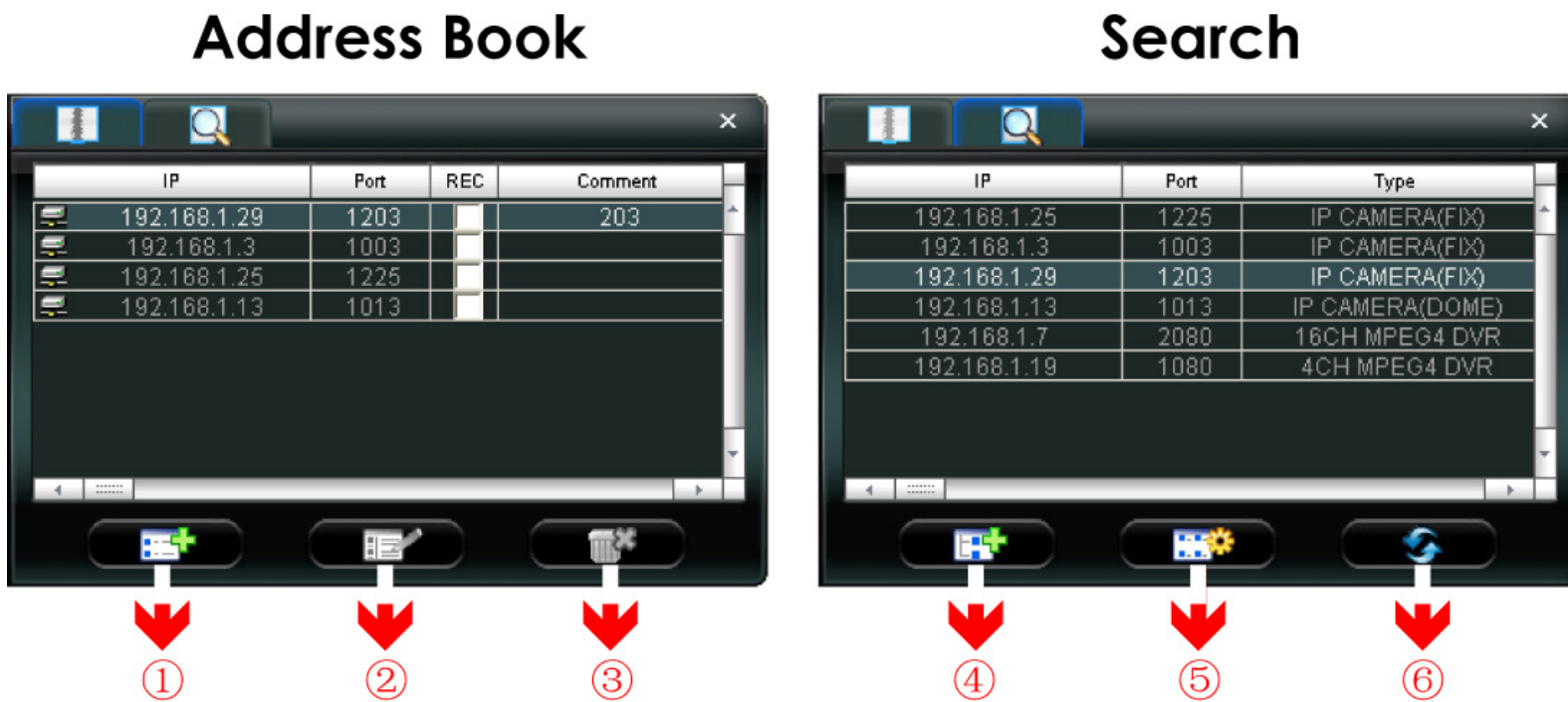





➤  (Address Book)

Click to view the pre-defined network camera access details.

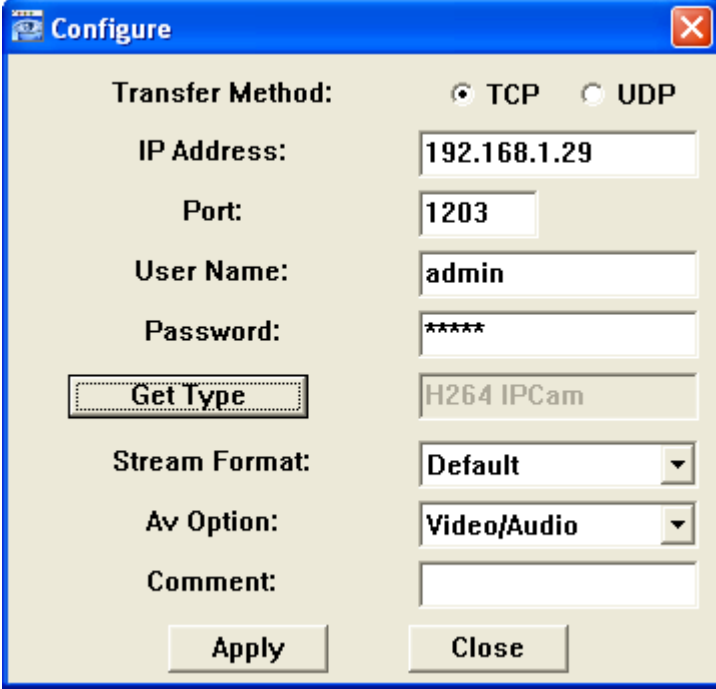

To log in, choose one IP address from the address list, and click the address twice; to log out, click the connected IP address twice.

You can also create new IP address information, or modify or remove the current IP address information.

NO.	Button	Function	Description
1		Add	Click to directly add one IP address for login. Key in all the network camera access information needed, and click "Apply" and "Close" to add the selected address to the address book. 
2		Edit	Select one current IP address from the address list, and click this button to edit the settings.
3		Remove	Select one IP address from the address list, and click this button to delete it.
	<input checked="" type="checkbox"/>	Record	Check this checkbox to enable the record settings. For details, please refer to the "5.3 Record Setting" on Page 16. The default setting is unchecked.



➤  **(Search)**

Click to search and view the available IP address(es) for the network camera connection. You can choose one address to add into the address book, edit the details, or update the address list.

NO.	Button	Function	Description
4		Add into address book	Select from the available IP address list, and click this button. Key in the network camera access information needed, and click "Apply" and "Close" to add the selected address to the address book.
5		Setting	Select from the available IP address list, and click this button to edit the setting.
6		Refresh	Click to update the available IP address list.

## 4.3 Emap

➤  **(Configure)**

Click  on the top bar, you will see the default emap screen. Then, click  (Configure) to enter the screen for emap setting.

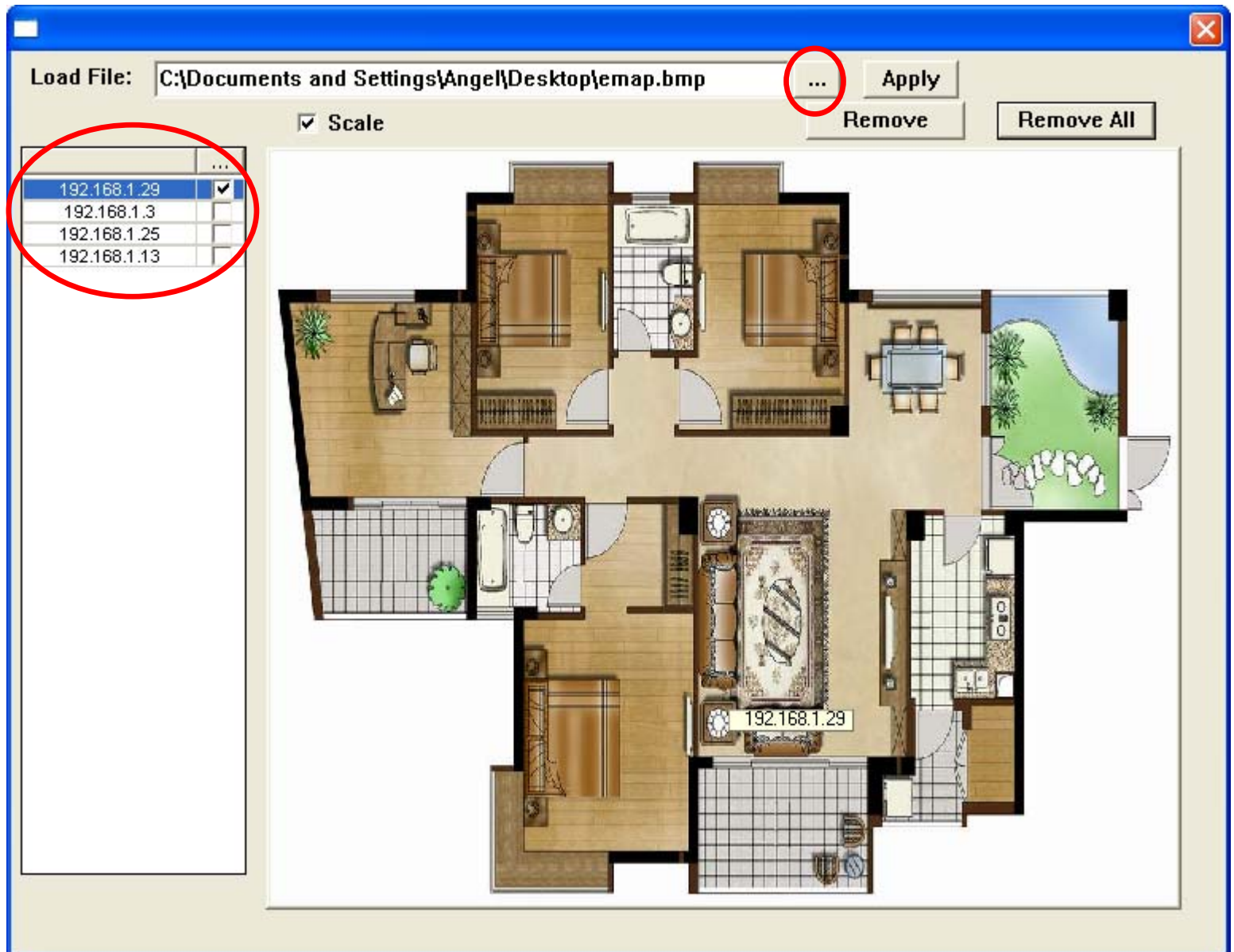

Step 1: Click "..." to load a .JPEG or .BMP file of the emap. If the picture is too large, you can tick off "Scale" to zoom it out.

Step 2: Drag the IP address of the connected camera onto the picture to set its location, and the IP address will be ticked off . After placing all the cameras, click "Apply" to confirm the setting. Then you will see the following screen.



Step 3: If you want to relocate the cameras, you can click “” (Configure), and then move the cameras on the emap at will. You can also click “Remove” / “Remove All” to remove a camera or all the cameras on the emap.

➤ **Live display on the emap**

Double click the icon of the camera on the emap. The live display of this camera will be shown.

➤ **Motion trigger prompt**

You can also see the prompt icon of motion trigger if any motion is detected.

---

**Note:** Please make sure you’ve activated the motion detection function at first. For the details about motion detection setting, please refer to “Trigger” on Page 21.

---

### Live Display





### Motion Trigger Prompt



## 4.4 Manual Record

- 1) Choose the record type and assign the record location

Click “” (Miscellaneous Control) → “” (Record Setting) to go to the “Record Setting” page. Check the record type “Manual”, and assign the location to save the recordings by double-clicking the “Video Path” cell.

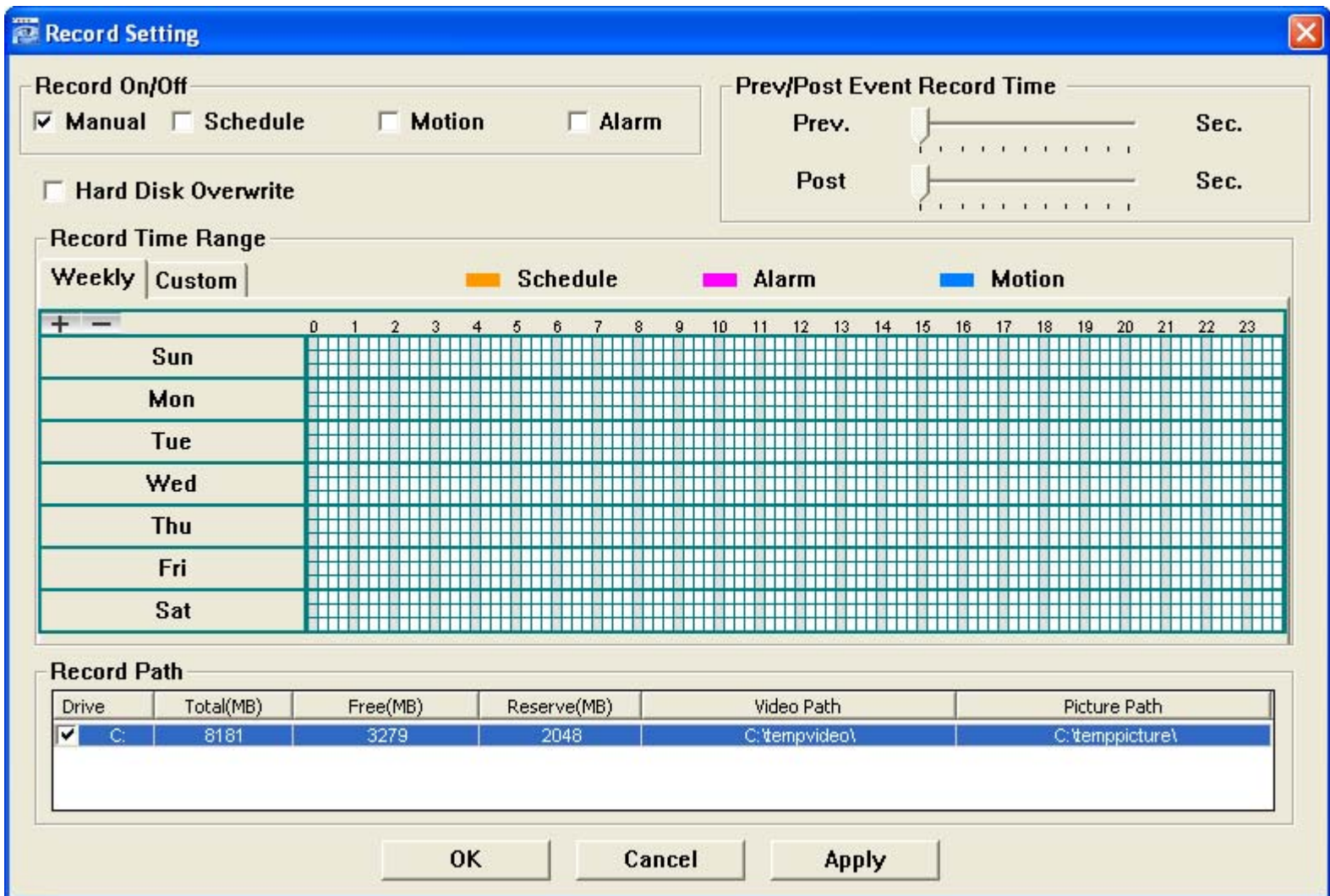

- 2) Start manual recording

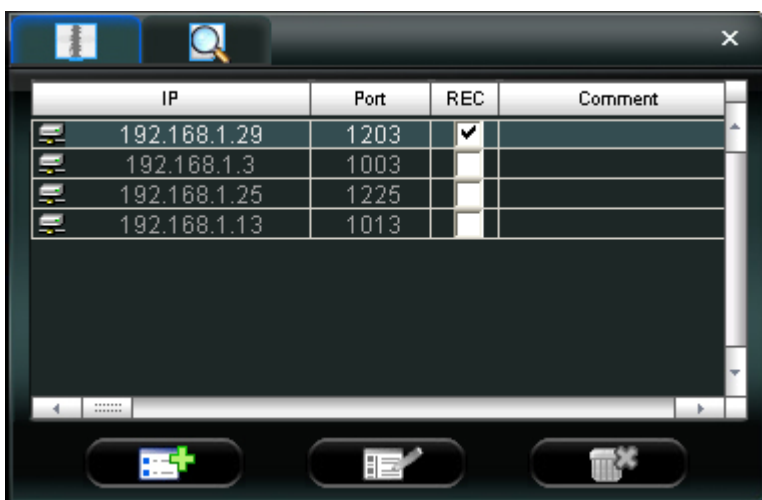

Once the “Manual” checkbox is checked in the “Record On/Off” section, check the “REC” box in the address book panel “” to start manual recording. When the record function is started, a flashing indication icon will be shown at the bottom right corner of the image display view. And the recordings will be saved in the specified location.



- 3) If you want to stop recording, click “” on the top bar or cancel ticking off “REC” in the address book

**Note:** For detailed schedule record setting, motion-triggered and alarm-triggered recording, please refer to “5.3 Record Setting” on Page 16 and “Trigger” on Page 21.

## 4.5 Playback

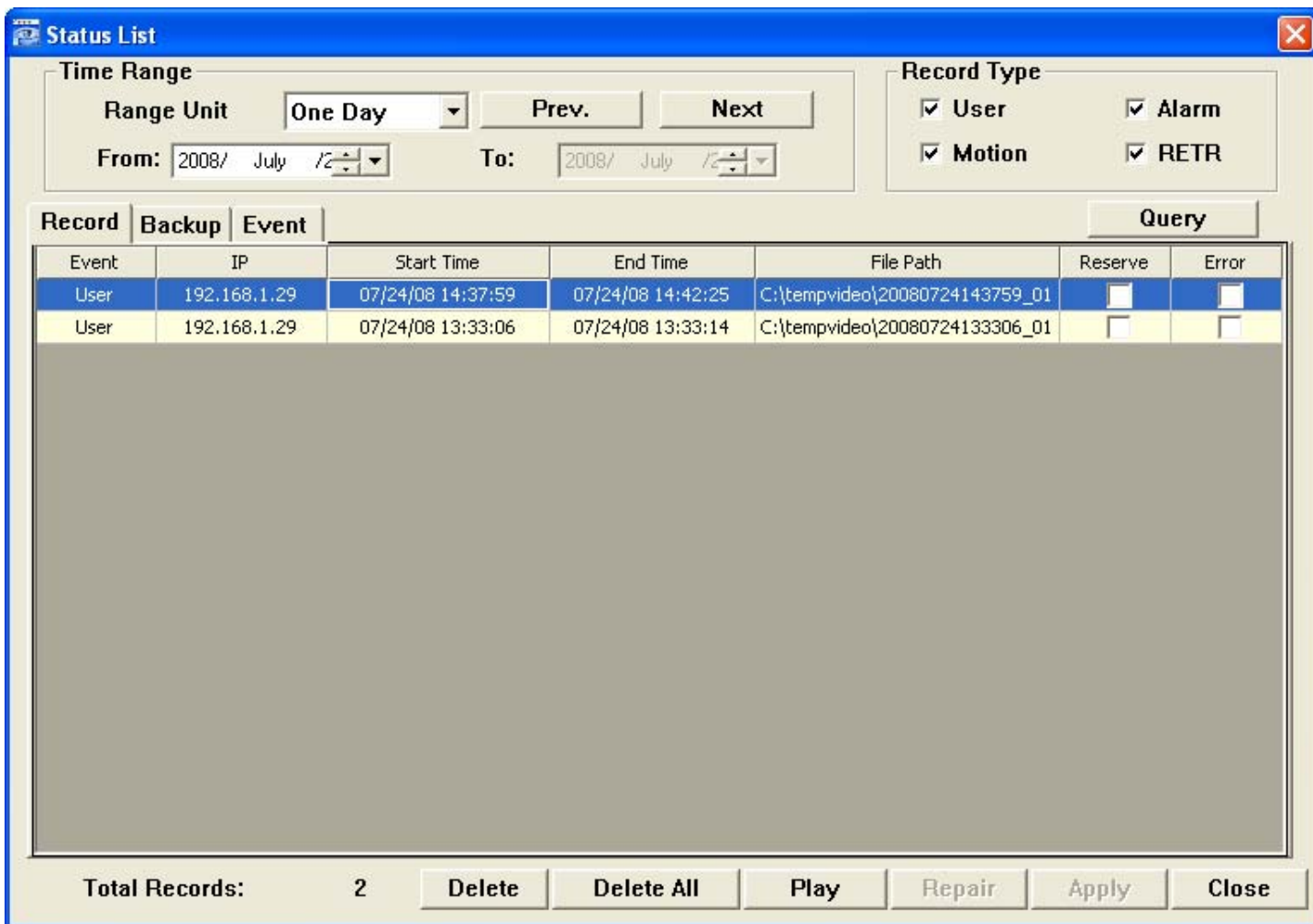

To play a recording, click “” (Miscellaneous Control) → “” (Status List), and select the “Record” tab. A list of all the recordings will be shown by defaults, and you can also sort out the logs you want to speed up the search time. For details, please see “5.6 Status List” on Page 29.



To immediately play a recording file, select a log from the list, and click “Play” button, or double-click the selected log. Then, the playback control panel will be shown at the bottom of the main control panel similar to the following. For the playback control panel details, please see “Playback Screen” on Page 31.



## 4.6 Snapshot

To take a snapshot of the current view, click “” (Snapshot) on the main control panel. Once the current view is captured, you’ll see an icon “” shown at the bottom right corner of the image display view.

The snapshot will be saved in the path you specified in “” (Record Setting). For snapshot path setting, please refer to “5.3 Record Setting” on Page 16.



## 4.7 Information

Click this button to show the current network connection details:

- |                  |                  |
|------------------|------------------|
| 1) IP Address    | 7) Resolution    |
| 2) Transfer Type | 8) Quality       |
| 3) Stream Format | 9) Server Time   |
| 4) AV Option     | 10) Online Users |
| 5) Bit Rate      | 11) Handler Name |
| 6) Frame Rate    | 12) Current Disk |





## 5. VIDEO VIEWER MISCELLANEOUS CONTROL PANEL





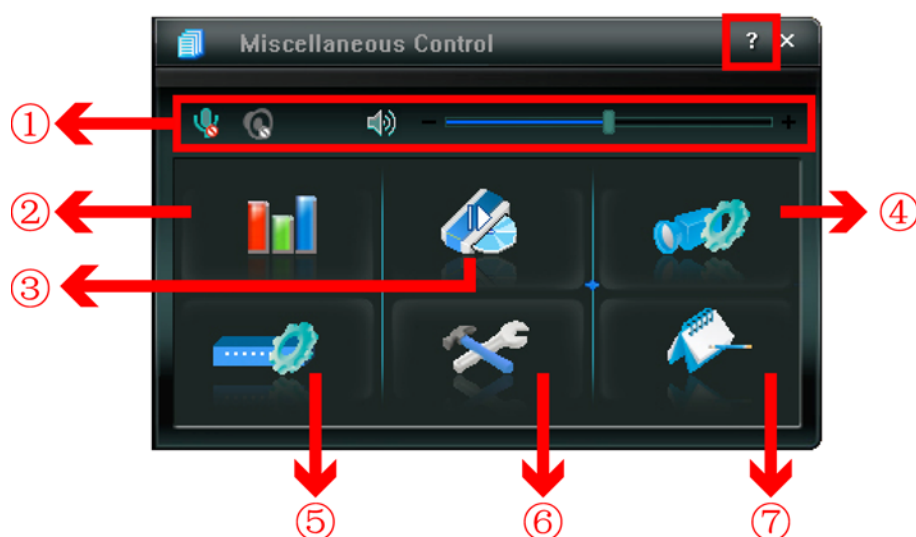





Click “” (Miscellaneous Control) on the Video Viewer control panel, and 7 functions are available as follows:

Click the button  to show the software version





Click the button  to show the current version of the Video Viewer.



The audio / broadcast function is only for AVI202, AVI212 and AVI203 models.

NO.	Button	Function	Description
①		Audio On / Off	Click this button to turn on / off the audio function of the network camera.
		Broadcast On / Off	Use the broadcast function from your PC to the connected network cameras. Please make sure the following items are ready before using this function. <ul style="list-style-type: none"> <li>Your PC is connected to a microphone device and has the Video Viewer software installed.</li> <li>The connected network cameras are connected to speakers.</li> <li>The audio function of the connected network cameras is turned on ().</li> </ul>
		Audio Volume Control	To adjust the volume of the audio, press and drag the volume slider.
②		Color Setting	Click this button to adjust the brightness / contrast / hue / saturation for the selected network camera. For details, please see “5.1 Color Setting” on Page 15.
③		Backup (For DVR only)	The network cameras don't support network backup function. This function is available when the Video Viewer is connected to a DVR. You can log into the DVR via this software and remotely backup the video data saved in the DVR. For details, please see “5.2 Backup” on Page 15.
④		Record Setting	Click this button to go to the detailed record setting. For details, please refer to “5.3 Record Setting” on Page 16.
⑤		Server Setting	Click this button to go into the detailed server setting. For details, please refer to “5.4 Server Setting” on Page 16.
⑥		Tools	Click this button to update the firmware version of your network camera. For details, please refer to “5.5 Tools” on Page 28.
⑦		Status List	Click this button to view all the record list and login/logout event list, search the desired log list(s) by date, or playback the recording of the selected log list. For details, please refer to “5.6 Status List” on Page 29.

## 5.1 Color Setting

In the live view page, choose the desired network camera from the image display tab. Click  (Miscellaneous Control) →  (Color Setting) to go into the “Color Setting” page, and you can adjust the brightness / contrast / hue / saturation for the selected network camera.





Click  (Set) to apply the change to the selected network camera. Click  (Default) and click  (Set) to return to the default color settings.

---

**Note:** You need to be a supervisor to operate this function. For details, please see “Account” on Page 19.

---

## 5.2 Backup (For DVR only)

The network cameras don’t have network backup function. This function is available when the Video Viewer is connected to a DVR. You can log into the DVR via this software and remotely backup the video data saved in the DVR. Click  (Miscellaneous Control) →  (Backup) to go into the “Backup” page, and you can select a specific time range or event to make a video backup of the recorded files saved in the DVR.

---

**Note:** You need to be a supervisor to operate this function. For details, please see “Account” on Page 19.

---

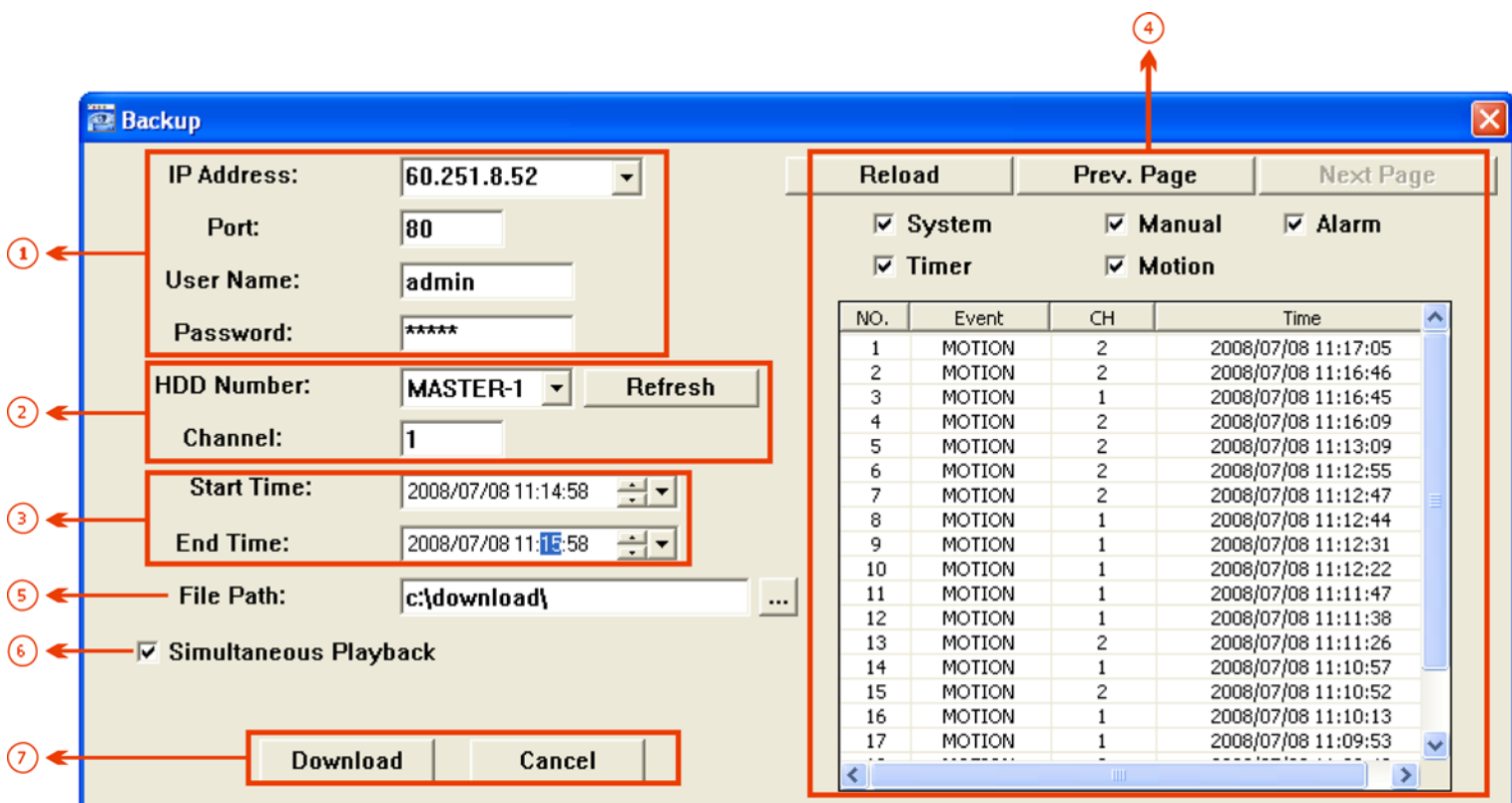

NO.	Function	Description
①	IP Address / Port / User Name / Password	Select the IP address of the desired network camera from the drop-down list and check if the network information is correct.
②	HDD Number / Channel	Specify the hard disk (HDD Number) and channel number (Channel) within which have the video data you need.
③	Filter the recorded video by time	Specify the time range within which has the video data you want in the "Start Time" and "End Time" columns.
④	Filter the recorded video by event	Select an event type from the event list. This list shows all logs in the specified network storage device from the latest to the earliest. <ul style="list-style-type: none"> <li>To quickly find the events you need, check or uncheck the event type "System" / "Manual" / "Alarm" / "Motion", and select the log you want.</li> <li>To view the earlier or later logs that are not shown in the current page, click "Prev. Page" or "Next Page".</li> <li>To refresh the event list, click "Reload".</li> </ul>
⑤	File Path	Assign the location where the backup files are saved.
⑥	Simultaneous Playback	To view the backup images simultaneously when the download process is in progress, select the checkbox "Simultaneous Playback". You will see the backup images while the images are being downloaded to the PC or notebook.  To simply backup images without previewing, deselect the checkbox "Simultaneous Playback". You will only see a message box indicating the total time needed, the current status and the saving location.
⑦	Download / Cancel	Click "Download" to start or "Cancel" to discard the video backup.

### 5.3 Record Setting

Click "Miscellaneous Control" → "Record Setting" to go into the "Record Setting" page, and you can set which type of the recording is enabled (Manual / Schedule / Motion / Alarm), and where the recorded data / snapshots are saved.

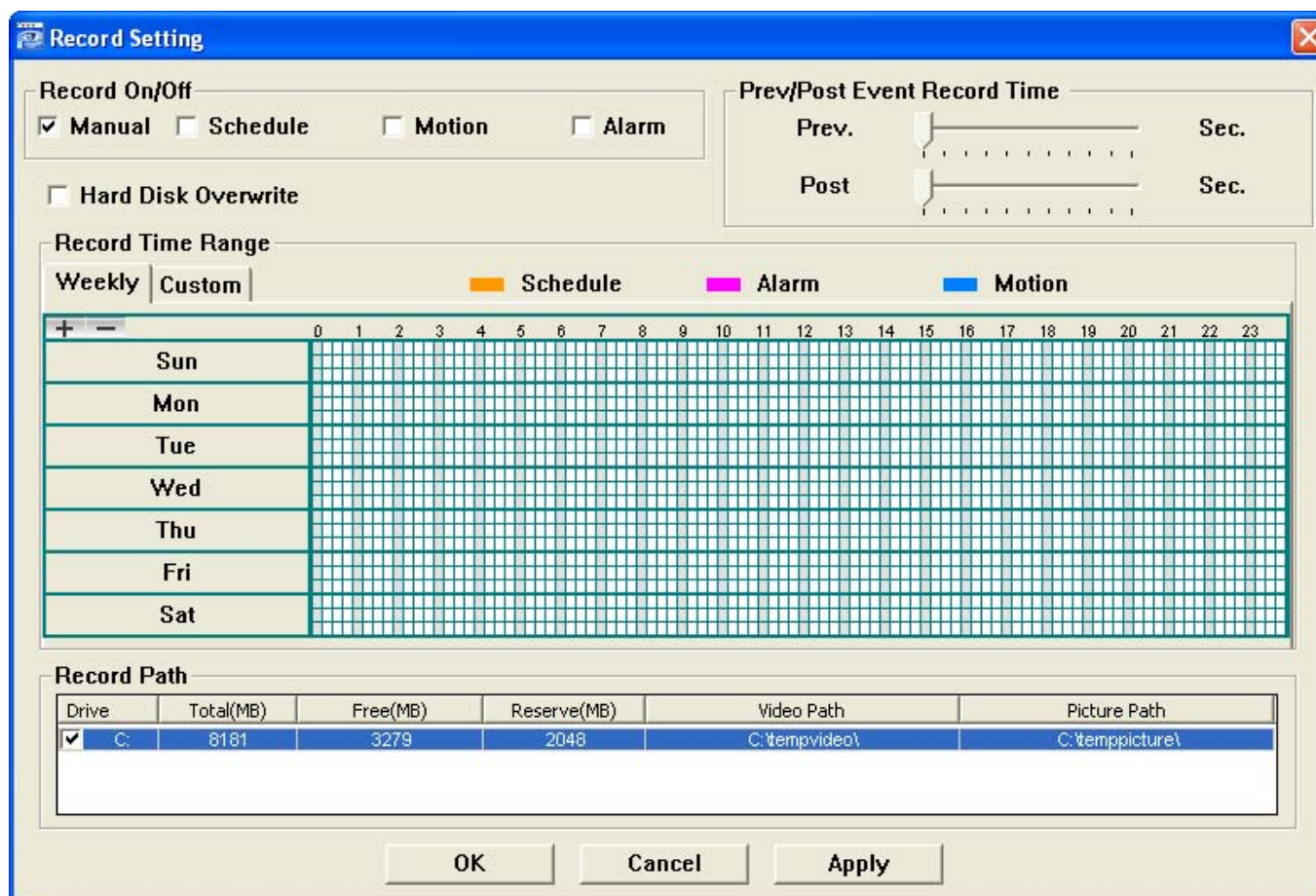

**Note:** Once all the record settings are finished, please check the "REC" checkbox in the address book panel "☑" to start manual recording. Please refer to "Address Book" on Page 8.

#### Record On/Off

In this section, you can select which type of the recording will be enabled. There are 4 options: Manual / Schedule / Motion / Alarm.

#### Prev / Post Event Record Time

In this section, you can set the pre- / post-event record time from 0 ~ 10 seconds by pressing and dragging the slider.

**Hard Disk Overwrite**

Check this checkbox to overwrite from the oldest recorded data when the HDD is full.

**Record Time Range**

There are two options available for you to set the recording time: Weekly & Custom.

## ◆ Weekly

Choose the time box(es) within which you want to enable the recording. The time scale is from 0 ~ 24 hours per day, and there are 3 time lines for each weekday, representing 3 different recording types.

When you select the time box(es), you may see the color orange, pink or blue:

orange => the 1<sup>st</sup> line, schedule record

pink => the 2<sup>nd</sup> line, alarm record

blue => the 3<sup>rd</sup> line, motion record

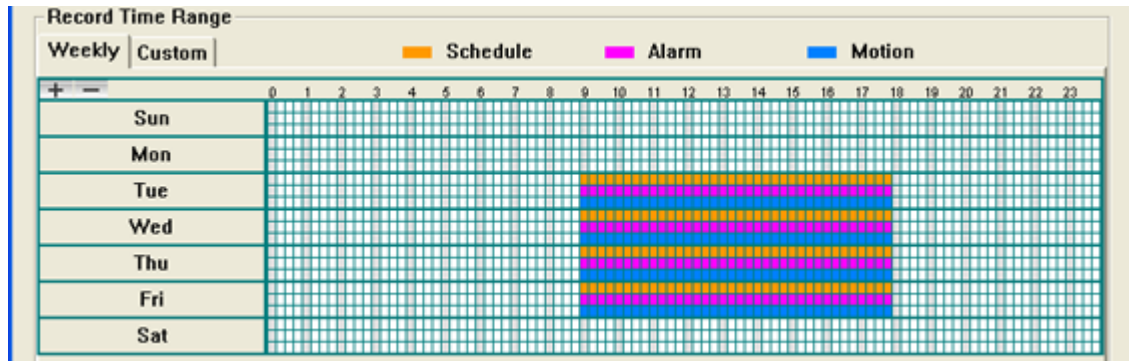

**Tip:** To set schedule record, alarm record and motion record all at once for the whole week, press “+” button. To clear all record time settings, press “-” button.

## ◆ Custom

To specify the more specific time for recording, click “Custom”.

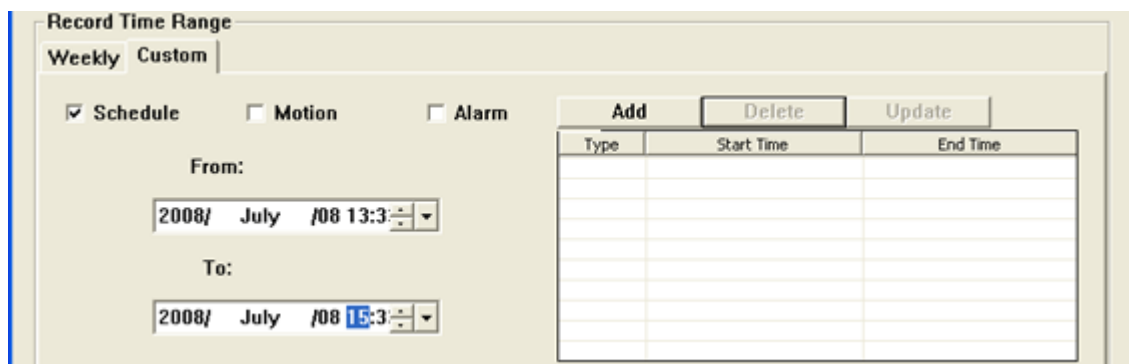

- Select the desired record type(s) (Schedule / Motion / Alarm), and set the start & end date and time.
- Press “Add”, and a pop-up window will appear and ask you to confirm your setting. Click “OK” to add the record setting, or “Cancel” to discard the setting.

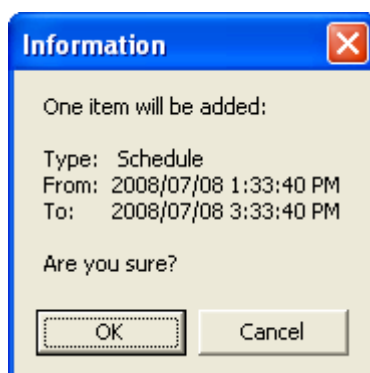

- After adding the record setting, you will see the item(s) you added in the custom record list. To delete a certain item, choose the item you want to delete, and click “Delete”. To modify a certain item, choose the item you want to modify, change the start time and end time, and click “Update”.

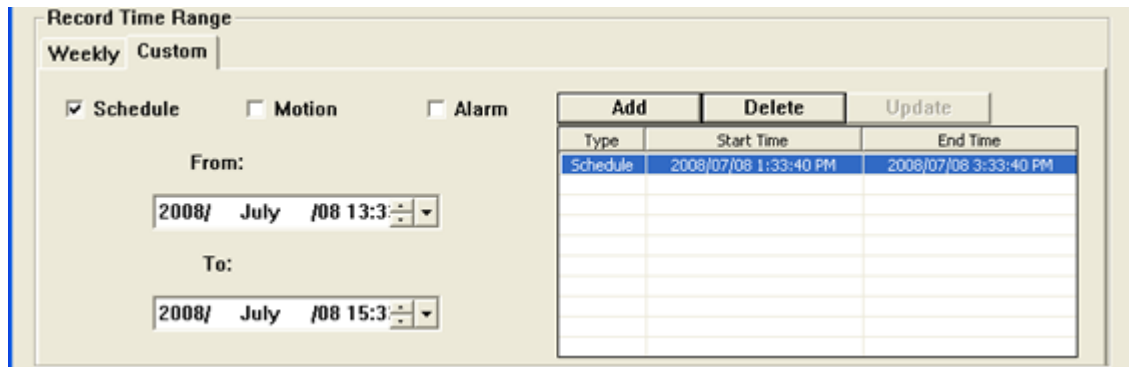

Record Time Range

Weekly Custom

Schedule  Motion  Alarm

From:

2008/ July /08 13:3

To:

2008/ July /08 15:3

Type	Start Time	End Time
Schedule	2008/07/08 1:33:40 PM	2008/07/08 3:33:40 PM

### Record Path

Select and view the location for saving the recorded video and snapshot pictures.

To change the saving path for the recorded video clips or snapshots, check the drive you want, click the cell of "Video Path" or "Picture Path" twice, and select a new path for saving the video clips or snapshots.

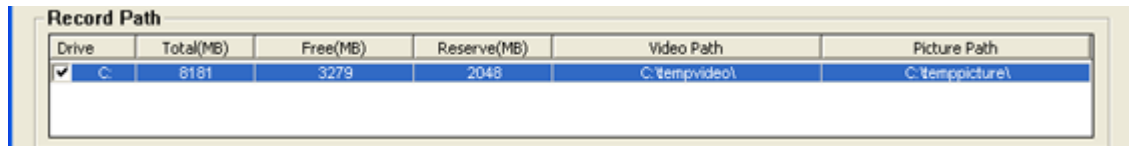

Drive	Total(MB)	Free(MB)	Reserve(MB)	Video Path	Picture Path
<input checked="" type="checkbox"/> C:	8181	3279	2048	C:\temp\video\	C:\temp\picture\

## 5.4 Server Setting

Click "Miscellaneous Control" → "Server Setting" to go into the "Server Setting" page, and you can view, set or modify all the network camera setting. All the changes you make here will be applied to the connected network camera.

**Note:** You need to be a supervisor to operate this function. For details, please see "Account" on Page 19.

### General

Click "Miscellaneous Control" → "Server Setting" → "General" to go into the "General" page. In "General" page, you will see the following items:



Server Setting : 192.168.1.29

General

Firmware Version: 1012-1005-1005-1000

MAC Address: 00:0E:53:0C:24:F3

Title: 01



OK

Cancel

Apply

Item	Description
Firmware Version	Display the current firmware version of the network camera.
MAC Address	Display the MAC address of the network camera.
Title	Provide a title for the network camera. Only 15 characters are allowed. The default camera title is "Camera1".

## Log

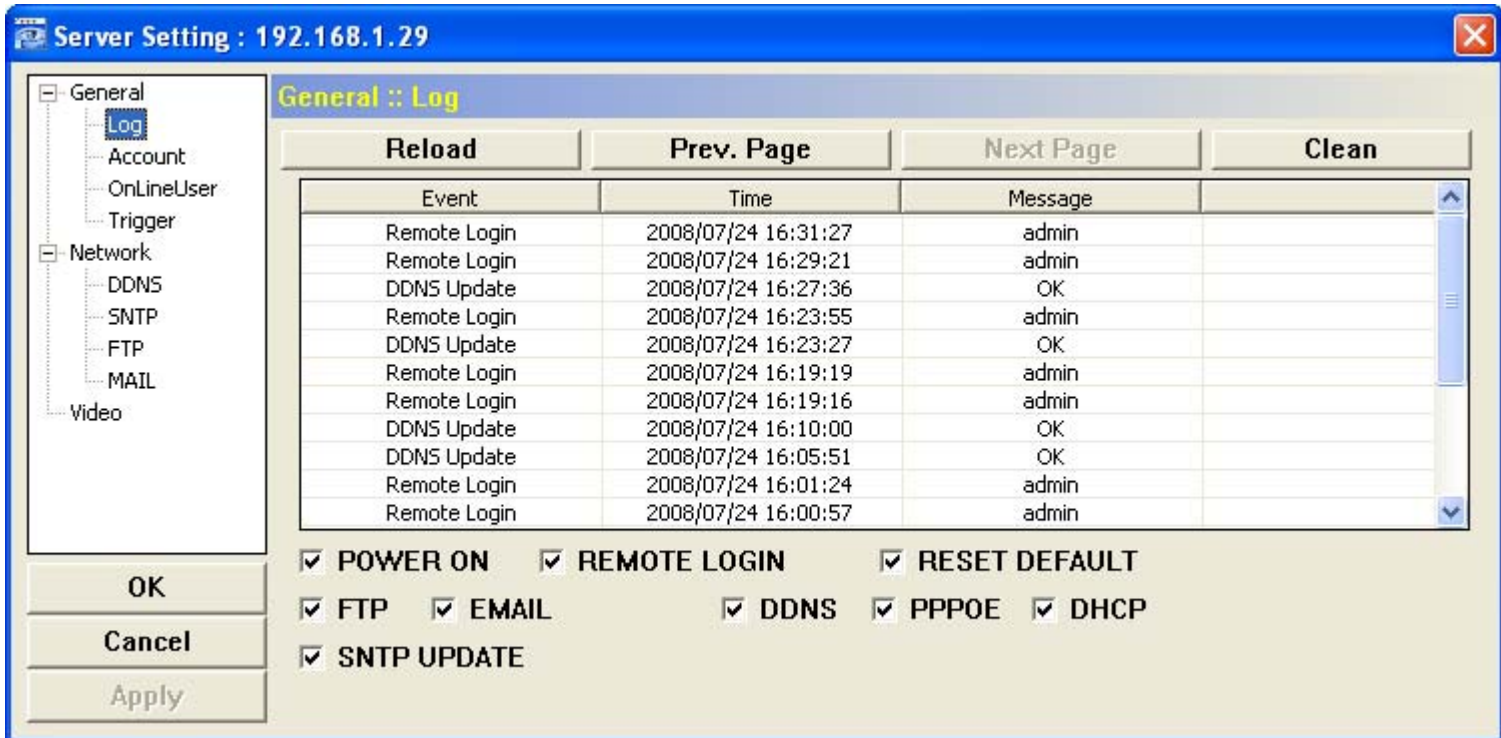

Click “” (Miscellaneous Control) → “” (Server Setting) → “General” → “Log” to go into the “Log” page. In the “Log” page, you can see all the logs for the network camera, such as “Power On”, “Reset Default”, “Net Login” and “SNTP Update” ... etc.

- To refresh the logs, click “Reload”.
- To view the earlier or later logs that are not shown in the current page, click “Prev. Page” or “Next Page”.
- To clear all the logs, click “Clean”.



Event	Time	Message
Remote Login	2008/07/24 16:31:27	admin
Remote Login	2008/07/24 16:29:21	admin
DDNS Update	2008/07/24 16:27:36	OK
Remote Login	2008/07/24 16:23:55	admin
DDNS Update	2008/07/24 16:23:27	OK
Remote Login	2008/07/24 16:19:19	admin
Remote Login	2008/07/24 16:19:16	admin
DDNS Update	2008/07/24 16:10:00	OK
DDNS Update	2008/07/24 16:05:51	OK
Remote Login	2008/07/24 16:01:24	admin
Remote Login	2008/07/24 16:00:57	admin

## Account

Click “” (Miscellaneous Control) → “” (Server Setting) → “General” → “Account” to go into the “Account” page. In the “Account” page, you can create a new account for login, or delete or modify the existing account setting.

To add an account, click “New”, and set the “User Name”, “Password”, “User Level” and “Life Time”. Then, click “Apply” to save your setting and create a new account.

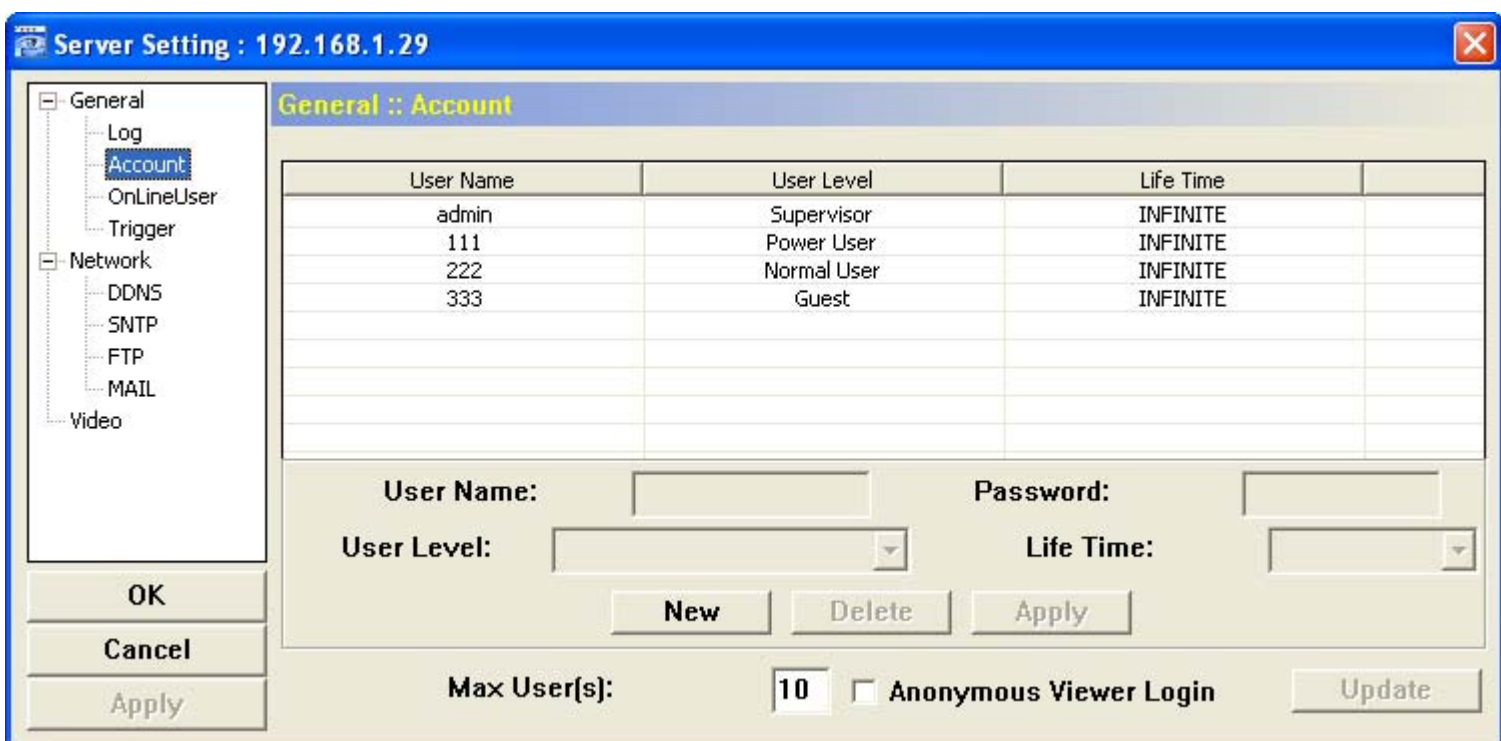

User Name	User Level	Life Time
admin	Supervisor	INFINITE
111	Power User	INFINITE
222	Normal User	INFINITE
333	Guest	INFINITE

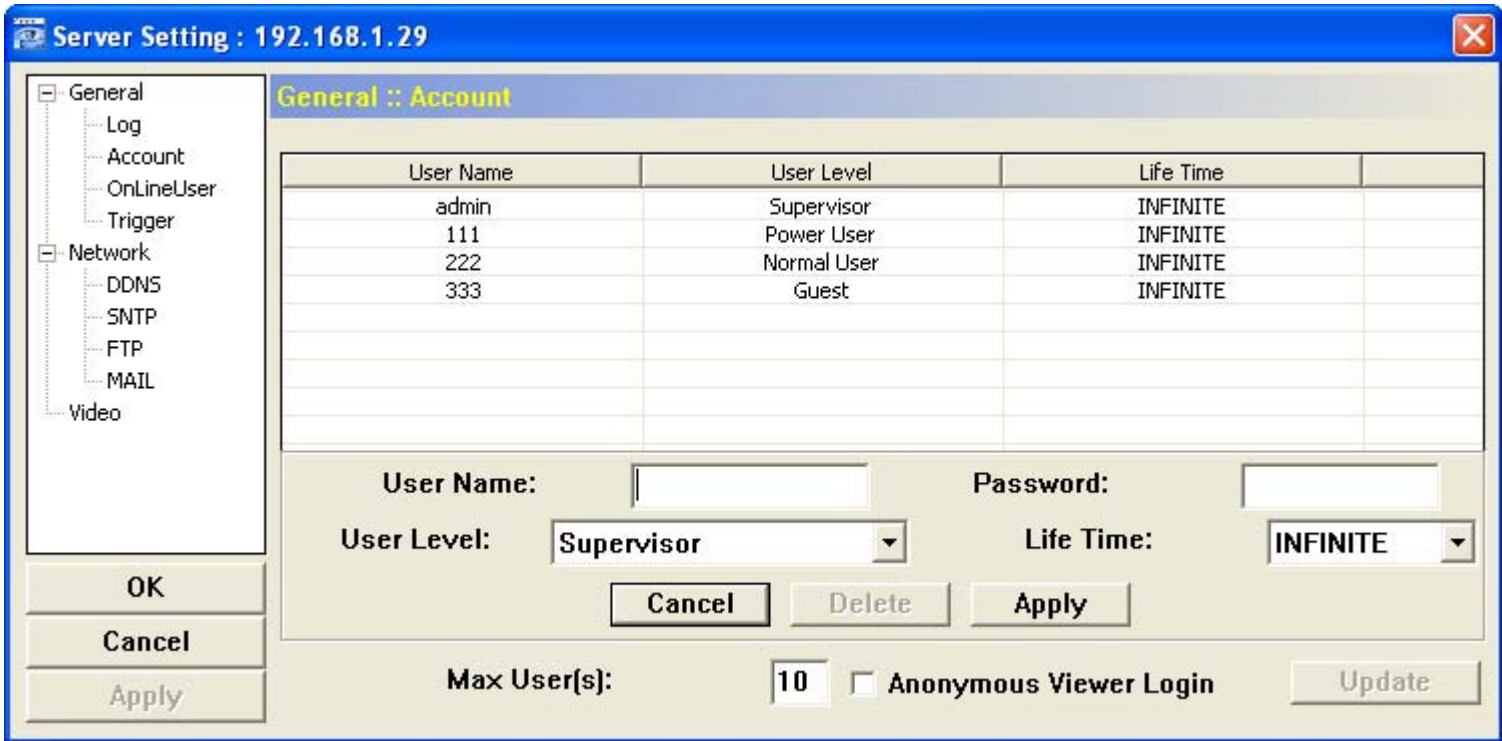

- To modify an existing account, select the account you want, change the setting, and click “Apply”.
- To remove an existing account, select the account you want, and click “Delete”.
- To save your changes, click “Apply”.

Column	Description
User Name	Set a user name that will be used for remote login. The user name allows up to 31 characters.
Password	Set the password that will be used for remote login. The password allows up to 31 characters.
User Level	Set the security level of an account to give the permission to control different Video Viewer functions. There are 4 user levels: “Supervisor”, “Power User”, “Normal User” and “Guest”. For the functions each user level is allowed to access. For details, please refer to APPENDIX 2 USER LEVEL FOR REMOTE OPERATION” on Page 39.
Life Time	Select how long this account is allowed to stay online (1 MIN / 5 MIN / 10 MIN / 1 HOUR / 1 DAY / INFINITE)
Max User(s)	Allow maximum 10 online users simultaneously

**Online User**

Click “” (Miscellaneous Control) → “” (Server Setting) → “General” → “OnLineUser”, and you can check all the online user information. To update the user information, click “Refresh”.

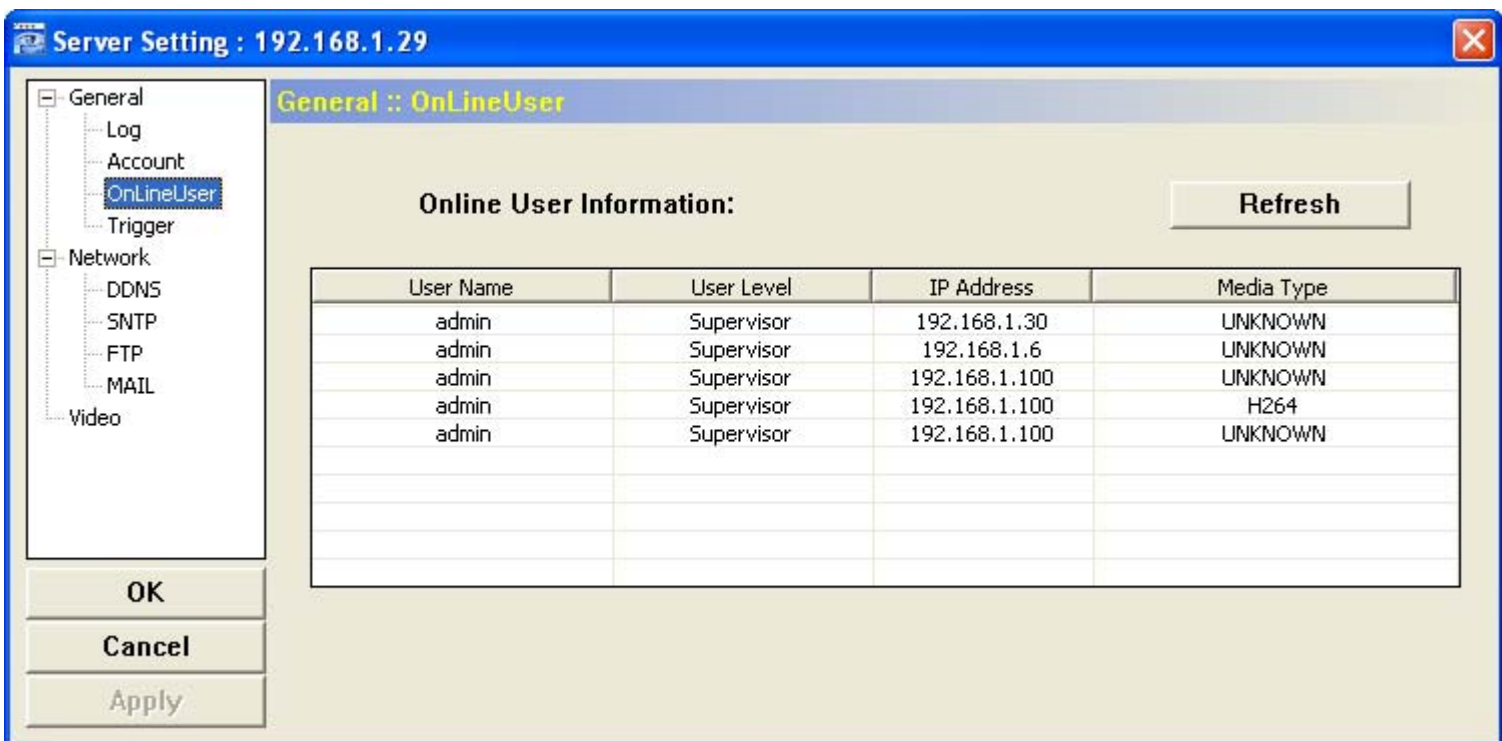

## Trigger

Click “” (Miscellaneous Control) → “” (Server Setting) → “General” → “Trigger” to enter this page.

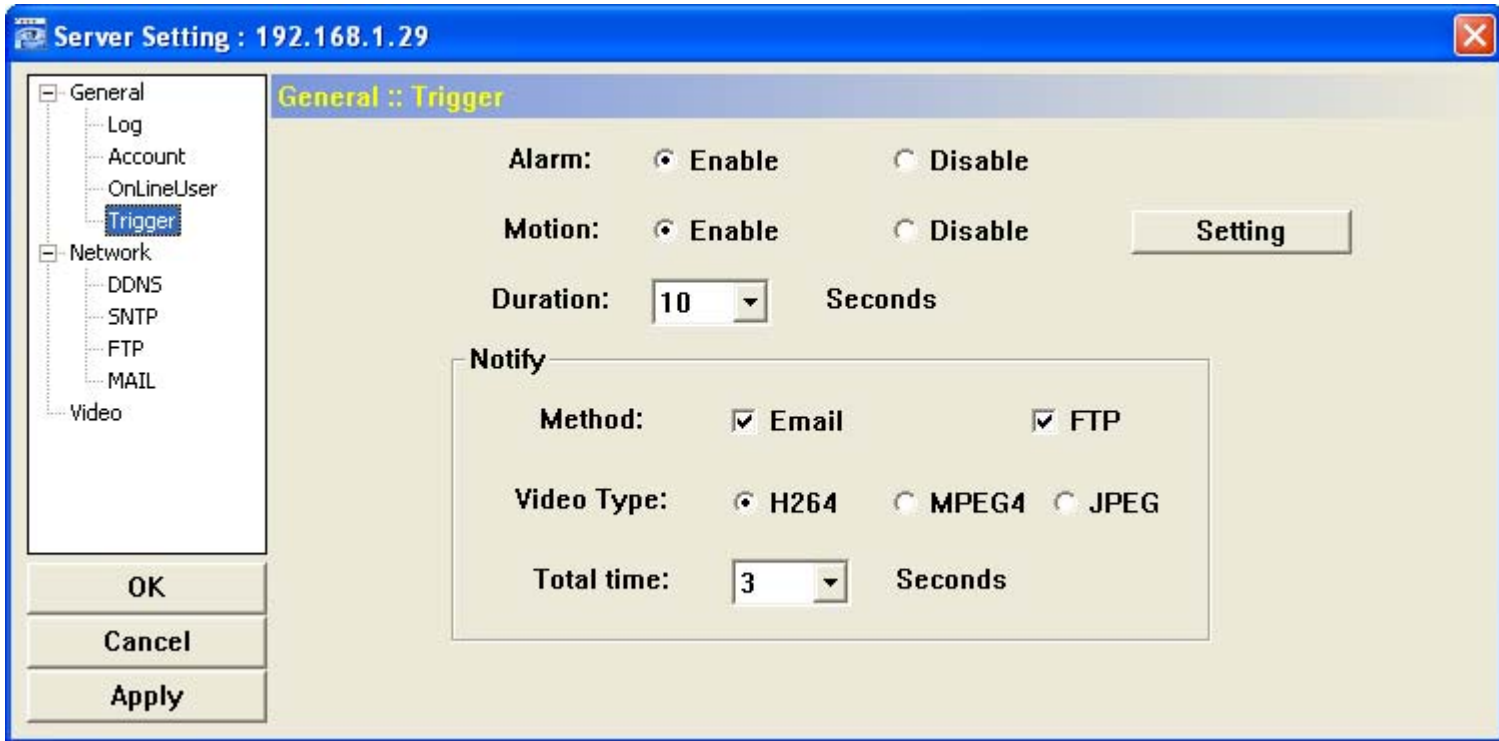

◆ Alarm Trigger (Only for AVI202 / 203 / 212):

In this section, you can select to enable the function of alarm trigger.

◆ Motion Trigger:

Item	Description
Motion	In this section, you can select to enable the function of motion trigger.
Duration	Set the duration time of the motion trigger recording (5 / 10 / 20 / 40 seconds).

Select to enable the function of motion trigger. And then click “Setting” to set the motion detection area.

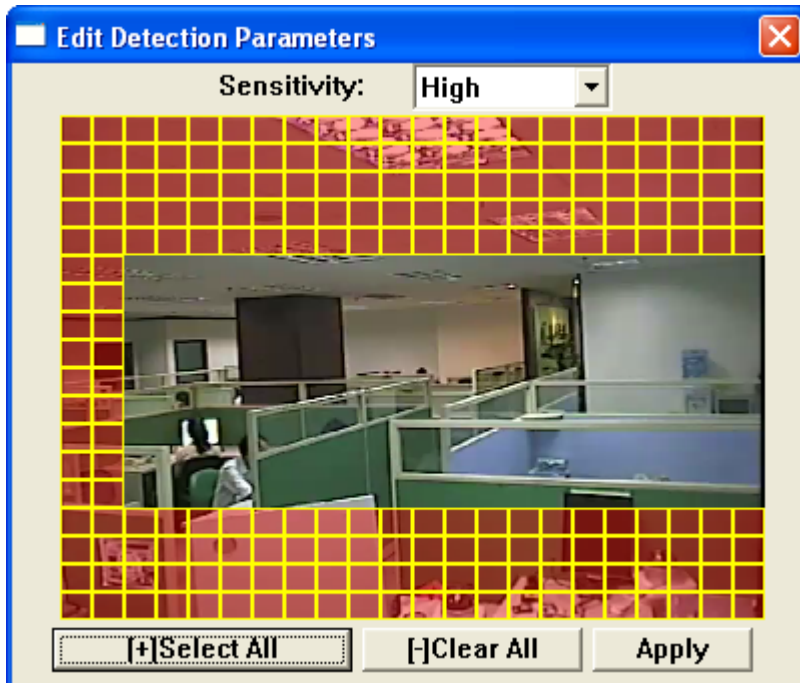

Function	Description
Sensitivity	Set the detection sensitivity: For AVI201 / 202 / 212 - 0 ~ 9 , the higher the number, the lower the sensitivity. For AVI203 - Low / Normal / High.
Motion Detection Setting Area	Set the motion detection area by selecting the area grids with your mouse. Pink grids represent the area that is not being detected while the transparent grids are the area under detection. You can set multiple areas under detection.
Select All	Click “+” (Select All) to set the whole area under detection.
Clear All	Click “-” (Clear All) to set the whole area undetected.



Function	Description
Apply	After setup, click "Apply" to confirm.

◆ Notify

In this section, you can select to enable the function of E-mail and/or FTP notification.

Item	Description
Method	<ul style="list-style-type: none"> <li>• <b>Email</b> If the E-mail notification function is activated, the network camera will send the captured video clip to the assigned E-mail address(s) once motion-trigger or alarm-trigger recording happened.</li> <li>• <b>FTP</b> If the FTP notification function is activated, the network camera will upload the captured video clip to the specified FTP site once motion-trigger or alarm-trigger recording happened.</li> </ul>
Video Type	Display the video type of the notification files. The video type will vary according to the setting of "Stream Format" in the "📖" (Address Book) page.
Total Time	If you've set the video type as H264 / MPEG4, you can set the record time of the notification video clip as 1 ~ 5 seconds. If you've set the video type as JPEG, then this option stands for 1 ~ 5 images.

**Note:** If your network camera & mail server are not connected by LAN, and the network connection is not stable or failed, the notification method by Email or FTP might be failed.

**Note:** Sometimes the length of the video clip emailed or uploaded might not be the same as the one you specified in "Total Time". This is because the system can only emailed or uploaded up to 500KB video clip.

## Network

Click "📖" (Miscellaneous Control) → "🔧" (Server Setting) → "Network" to go into the "Network" page. In "Network" page, you can set the network configuration of the network camera.

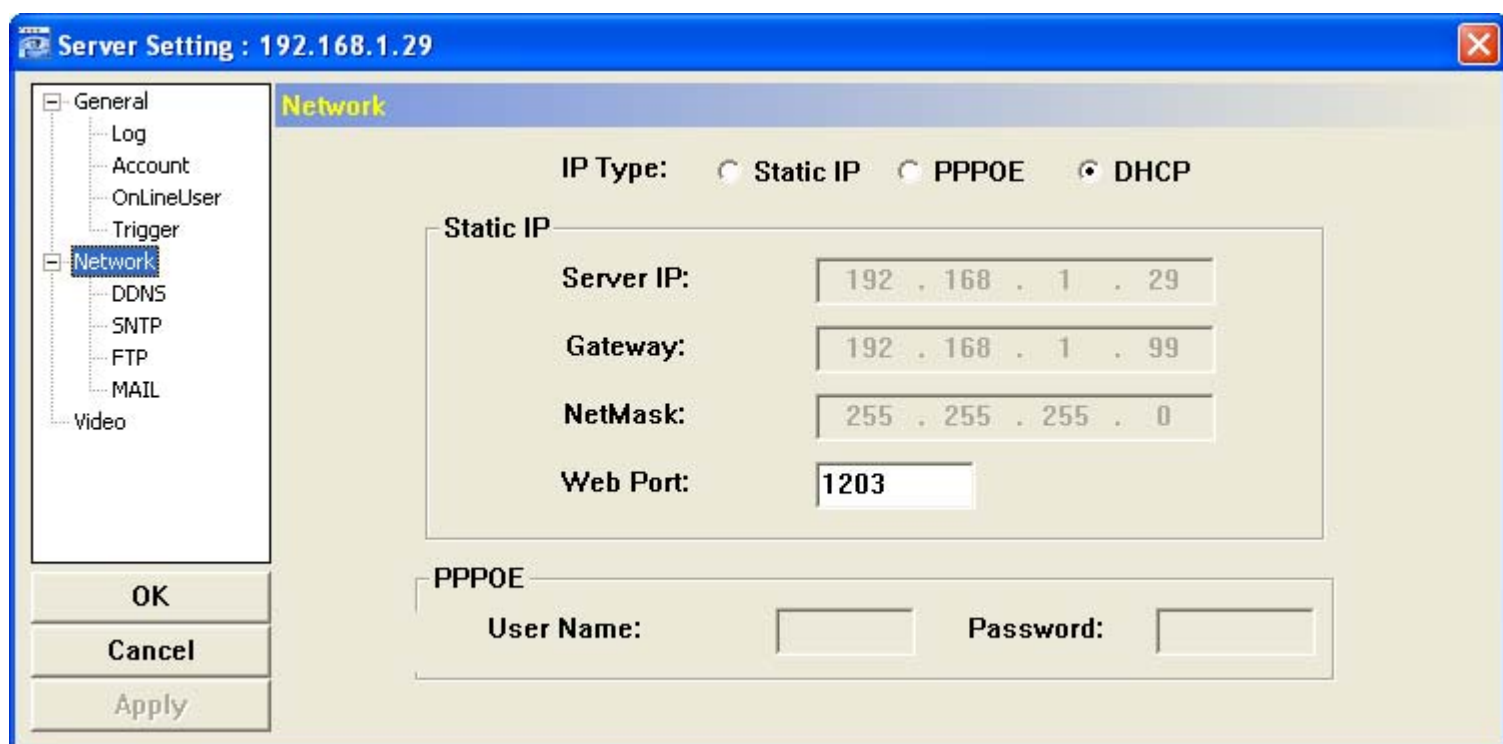



Select the network type you will be using for the network camera connection. There are 3 network connection types: Static IP, PPPOE and DHCP.

**Note:** PPPOE and DHCP network connection types are required to apply the DDNS service to get a "Hostname" to correspond to a dynamic IP address. Please refer to "DDNS" section for details.

Function	Description
Web Port	Typically, the default TCP port used by HTTP is 80. However, in some cases, it is better to change this port number for added flexibility or security. The valid web port number ranges from 1 to 9999.
Static IP	Computers are communicated and recognized by their own unique IP addresses over the Internet. "Static IP" provided by your ISP (Internet Service Provider) means the IP address of the computer is fixed. Key in the server IP address, gateway and network information provided by your ISP provider to configure a static IP network connection.
PPPOE	PPPOE stands for Point-to-Point Protocol over Ethernet. Users can easily have the Internet service as long as they're ready for the following things: 1) Insert an Ethernet card into the PC. 2) Obtain the ADSL service via any ISP. 3) Obtain and install the PPPOE software CD.  When everything is ready, choose the "PPPOE" IP type, and key in the user name and password provided by your ISP. Then, select "Network" → "DDNS" to set DDNS settings. For detailed DDNS settings, please refer to "DDNS" section.
DHCP	This DHCP function needs to be supported by a router or cable modem network with the DHCP service. Choose the "DHCP" IP type, and select "Network" → "DDNS" to set DDNS settings.  For detailed DDNS settings, please refer to "DDNS" section.

## DDNS

You need to apply a DDNS account before setting PPPOE or DHCP connection. DDNS is a service for transforming the dynamic IP corresponding to a specific "host name". Go to a website which provide free DDNS services and apply a host name.

Click " (Miscellaneous Control) → " (Server Setting) → "Network" → "DDNS" to enter.

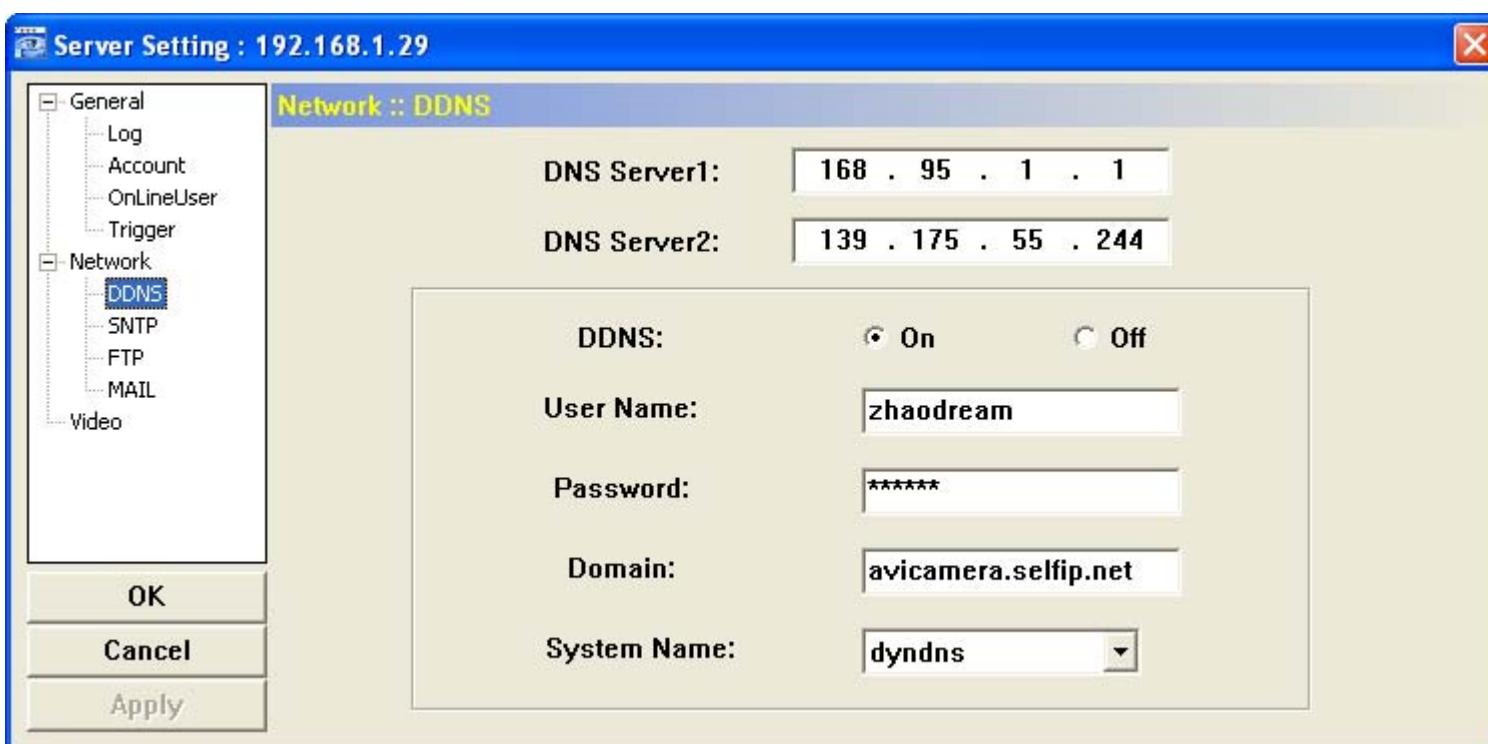

The screenshot shows the "Server Setting : 192.168.1.29" window. The left sidebar has a tree view with "Network" expanded and "DDNS" selected. The main area is titled "Network :: DDNS" and contains the following fields:

- DNS Server1: 168 . 95 . 1 . 1
- DNS Server2: 139 . 175 . 55 . 244
- DDNS:  On  Off
- User Name: zhaodream
- Password: \*\*\*\*\*
- Domain: avicamera.selfip.net
- System Name: dyndns (dropdown menu)

Buttons for "OK", "Cancel", and "Apply" are visible at the bottom left.

### ◆ DDNS Apply:

Under the connection of PPPoE or DHCP, you could key in the domain name which points to the IP address of your DVR to login. However, you need apply for a DDNS account at first.

Go to <http://www.dyndns.com> and sign up a DDNS account.

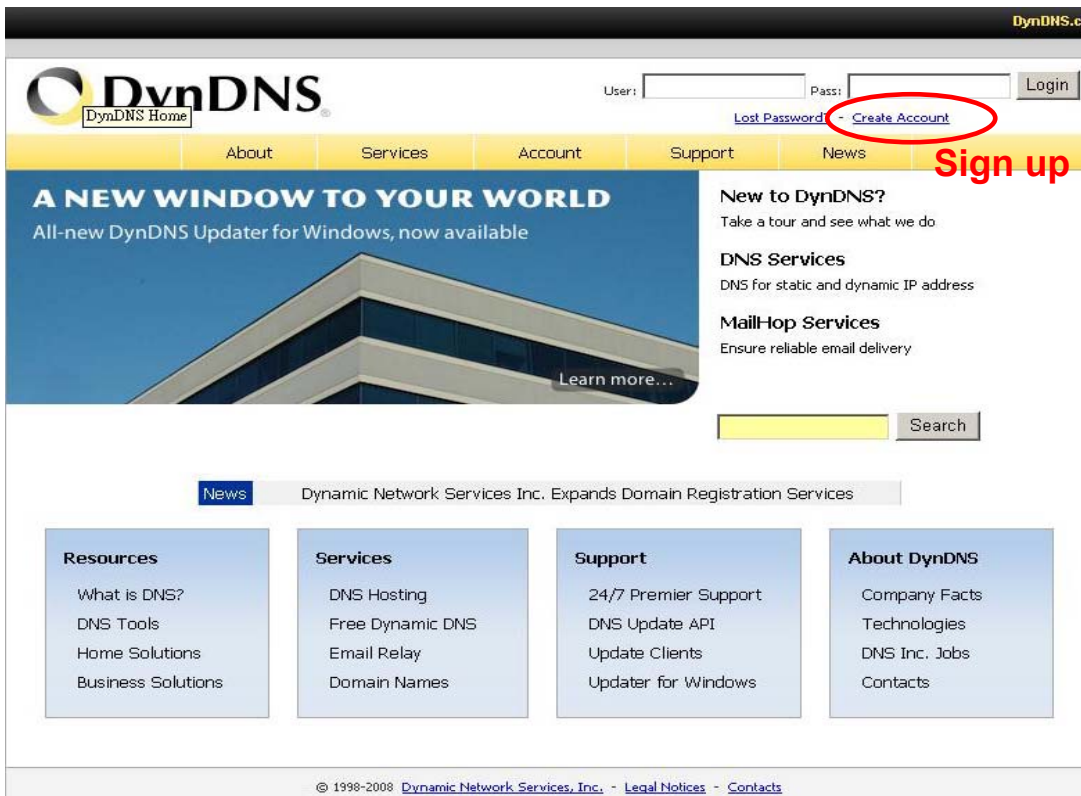

Enter all the information necessary for signing up an account according to the website instructions.

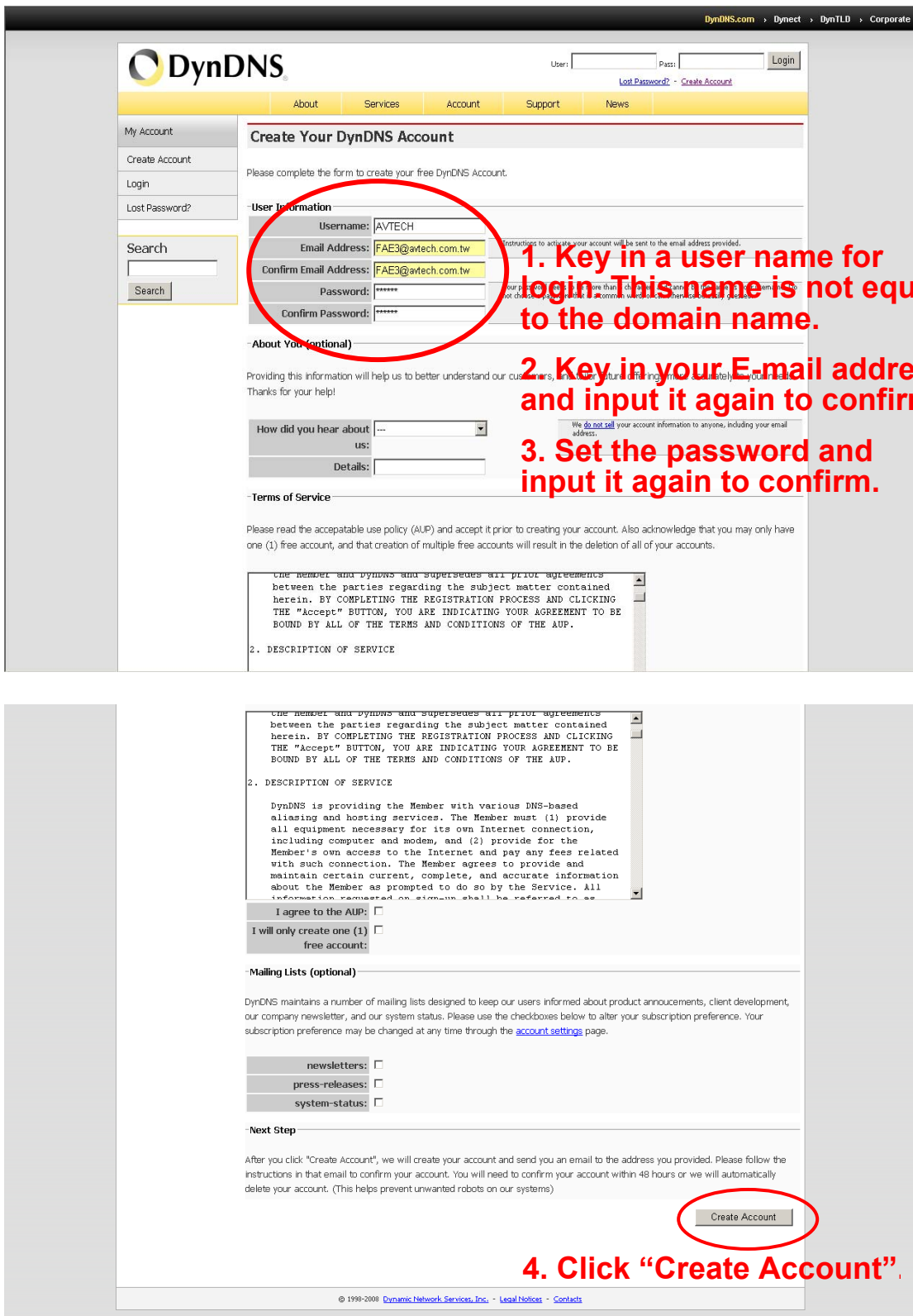

Then, you will see the screen "Account Created", and DynDNS will email the instructions to your specified E-mail

address. Please read this email within 48 hours and complete the procedure to activate your account according to the instructions in the email.

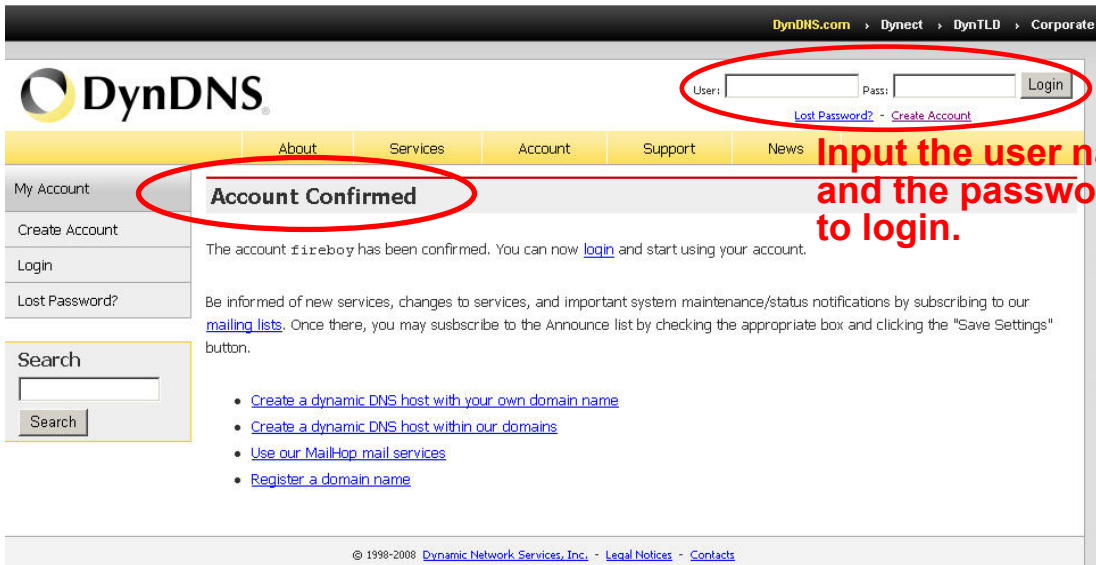

Go to the hyperlink in the email and you will see "Account Confirmed". Your account is created successfully now. Input the user name and the password you preset before to log in.

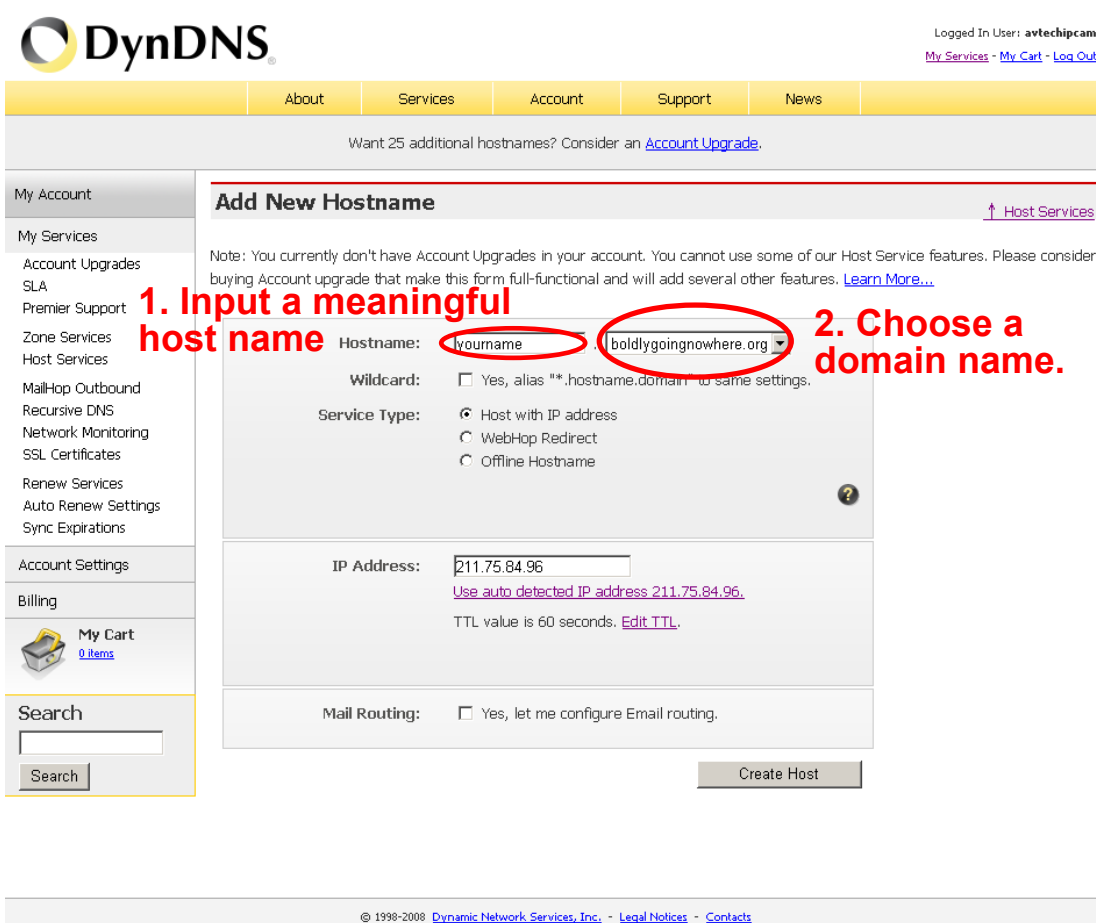
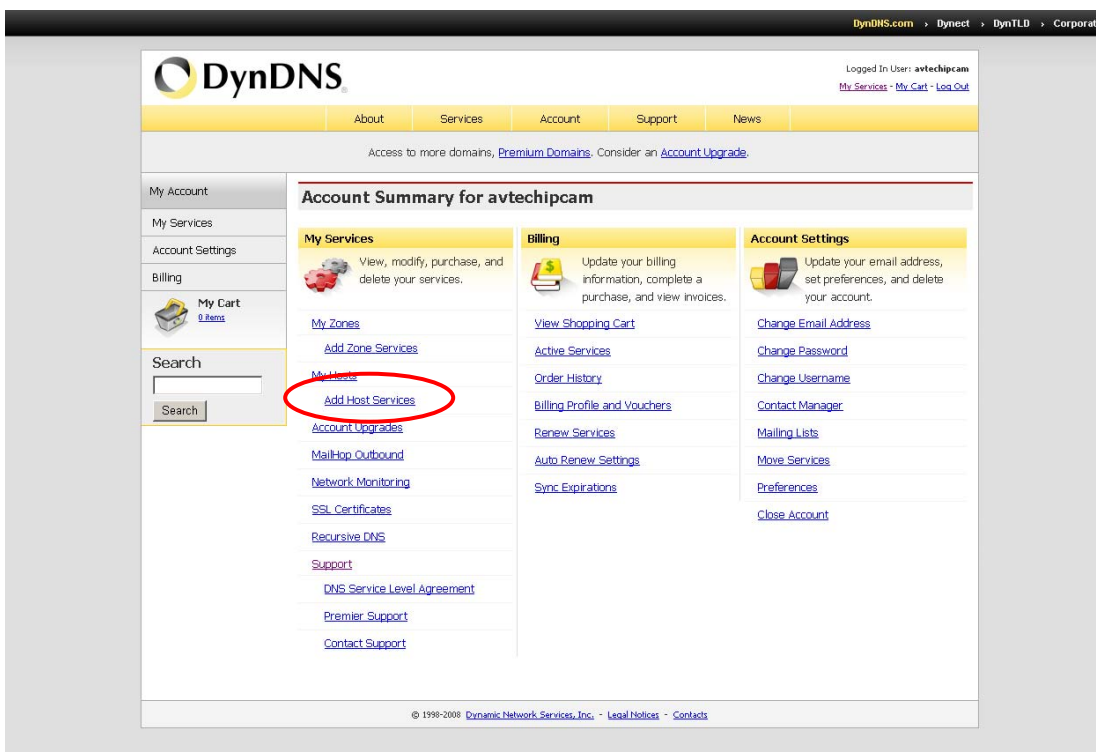

Click "Add Host Services"



SNTP

SNTP (Simple Network Time Protocol) is for time setting. Click “” (Miscellaneous Control) → “” (Server Setting) → “Network” → “SNTP” to go into the “SNTP” page.

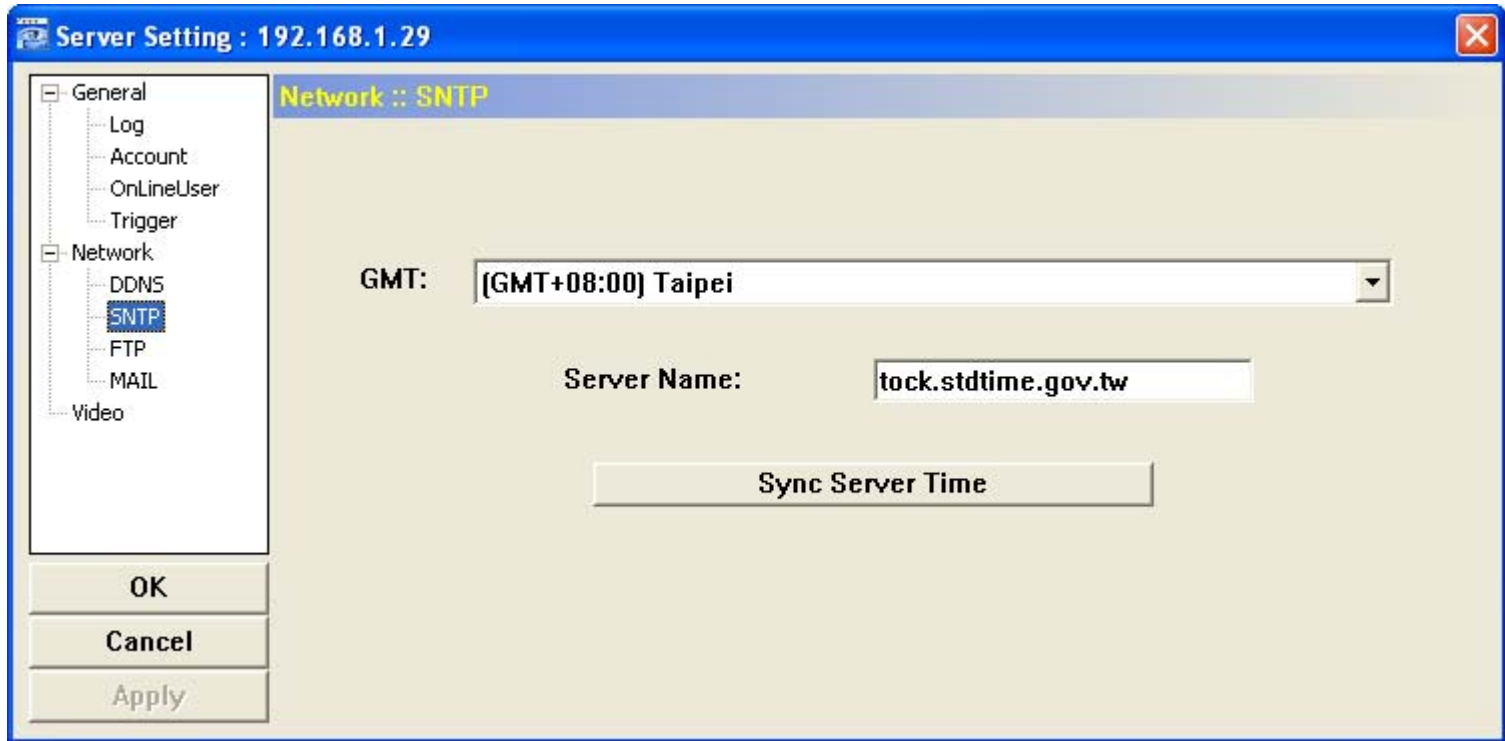

Function	Description
GMT (Greenwich Mean Time)	Once users choose the time zone, the network camera will adjust the local area time of the system automatically.
Server Name	Users can simply use the default SNTP server (For example, time.stdtime.gov.tw).
Sync Server Time	The network camera will synchronize the time with the network time.

FTP

Click “” (Miscellaneous Control) → “” (Server Setting) → “Network” → “FTP” to go into the “FTP” page.

Enter the detailed FTP information and press “Apply” to confirm. The information you set here will be applied when the function of FTP notification is enabled in the "Trigger" menu.

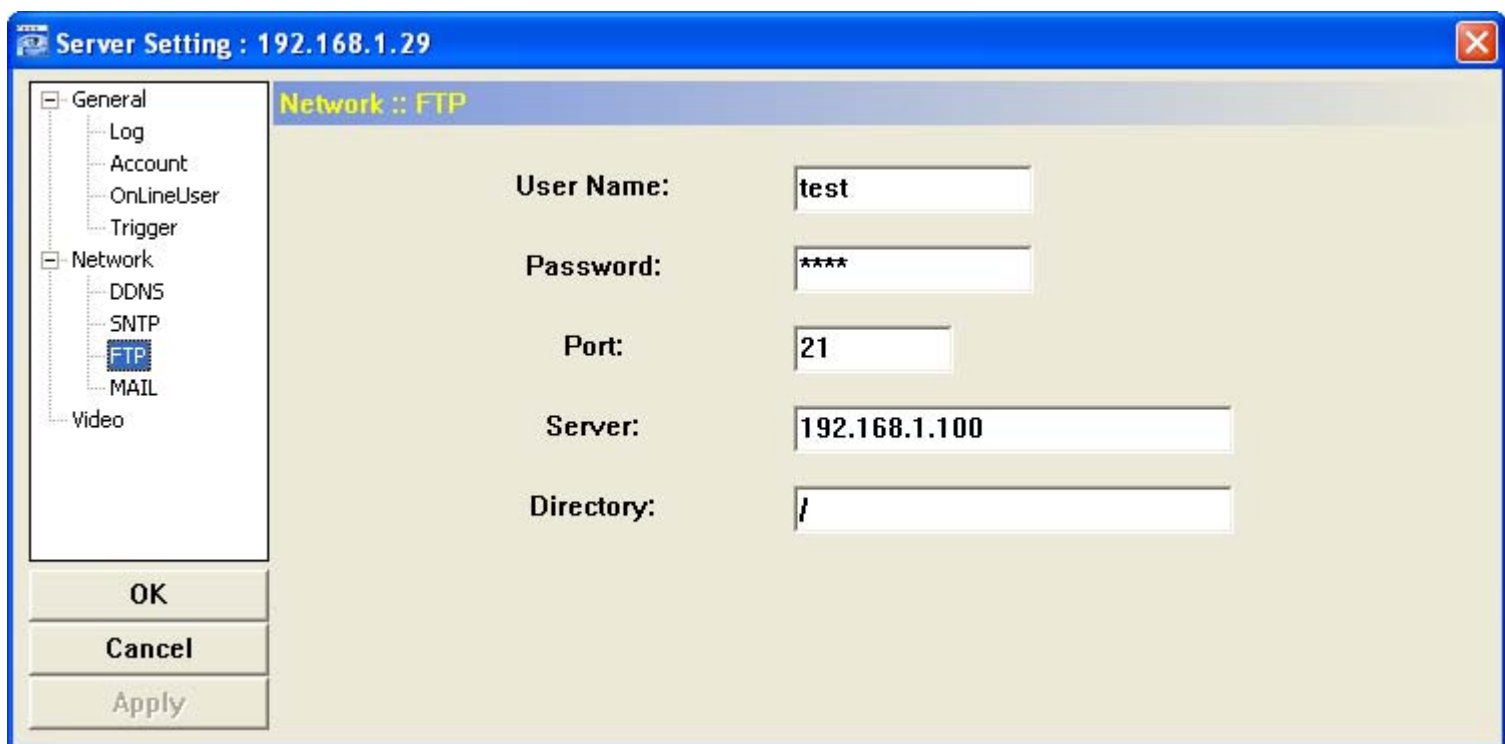

## MAIL

Click “” (Miscellaneous Control) → “” (Server Setting) → “Network” → “MAIL” to go into the “MAIL” page.

Enter the detailed E-mail information and press “Apply” to confirm. The information you set here will be applied when the function of E-mail notification is enabled in the "Trigger" menu.

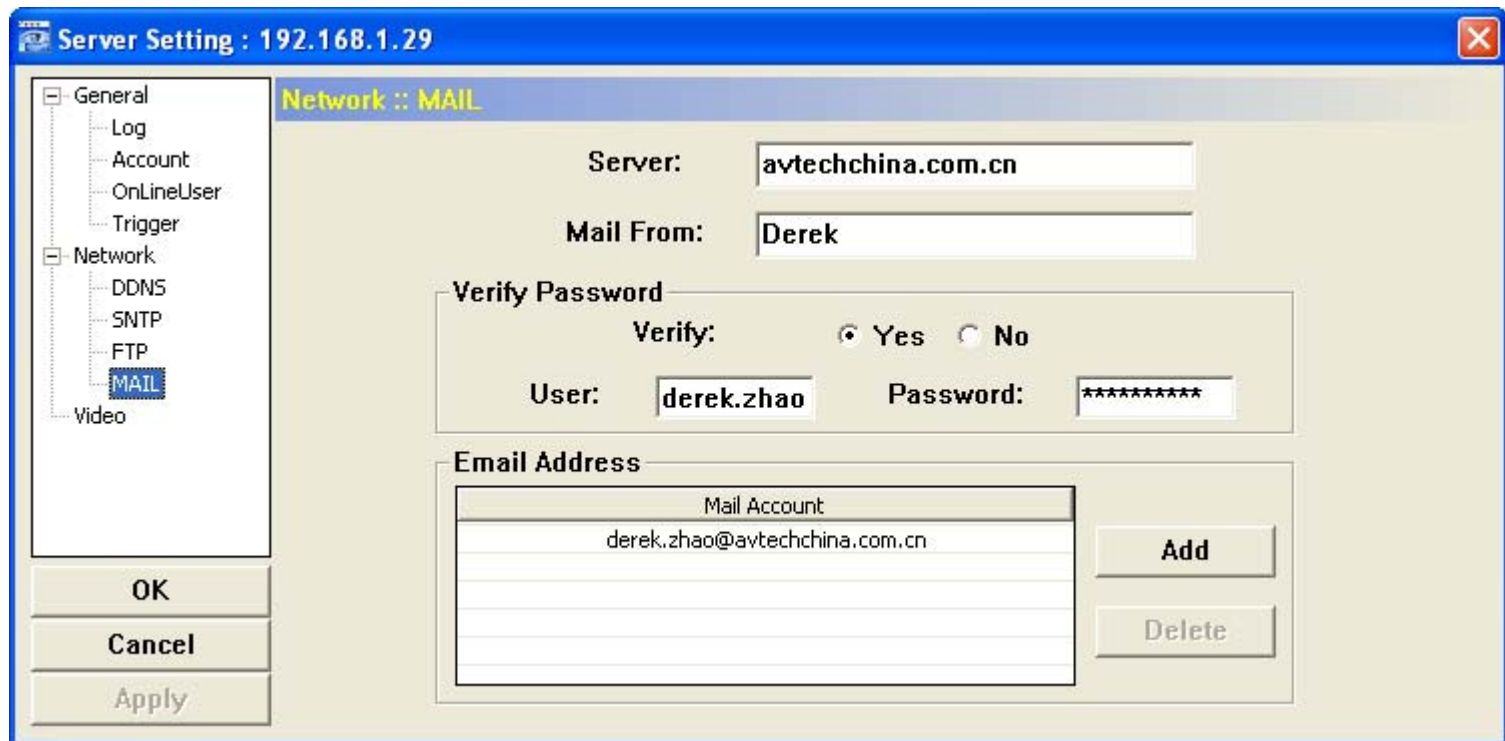

Function	Description
Server	Enter the SMTP server address provided from your e-mail system supplier.
Mail From	Enter the entire mail address to ensure E-mails will not be blocked by SMTP.
Verify Password	Some mail servers are required to verify the password. Please enter the “user name” and “password”.
Email Address	Add the E-mail address(s) of the assigned recipient(s).

**Note:** Users can assign up to 4 mail accounts for E-mail notification.

## Video

Click “” (Miscellaneous Control) → “” (Server Setting) → “Video” to go into the “Video” page.

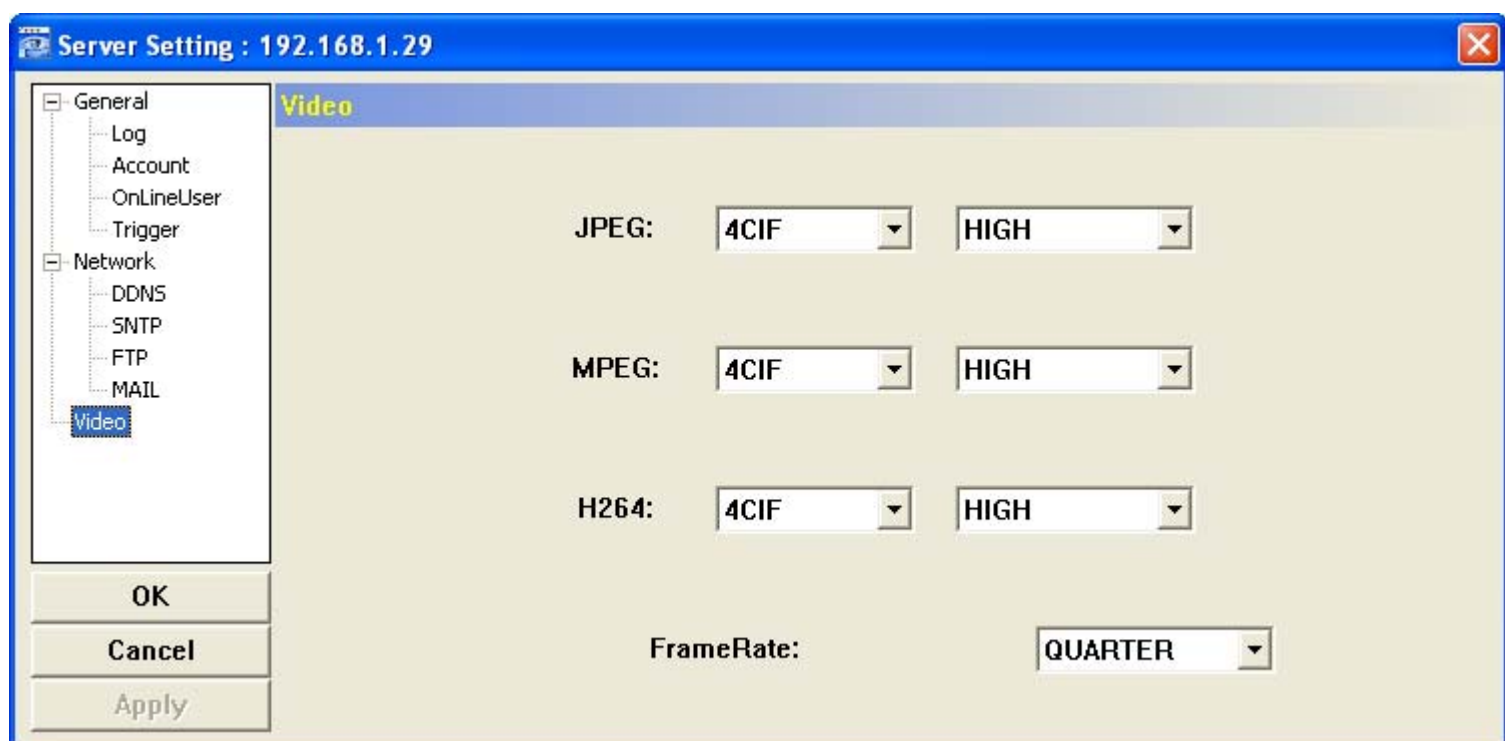

Item	Description
JPEG	Choose the image size (4CIF / CIF) and picture quality (BEST / HIGH / NORMAL / BASIC) when the web transmission format is JPEG.
MPEG	Choose the image size (4CIF / CIF) and picture quality (BEST / HIGH / NORMAL / BASIC) when the web transmission format is MPEG.
H264	Choose the image size (4CIF / CIF) and picture quality (BEST / HIGH / NORMAL / BASIC) when the web transmission format is H264.
Frame Rate	The frame rate allowed to each viewer can be adjusted to adapt to the bandwidth on the network. Set the desired image frequency to the maximum (FULL) or to a specified frame rate (HALF / ONE THIRD / QUARTER / ONE FIFTH / ONE TENTH). The actual frame rate depends on the actual network connection, and may be lower than the specified one.

## 5.5 Tools

Click “” (Miscellaneous Control) → “” (Tools) to go into the “Tools” page.

**Note:** You need to be a supervisor to operate this function. For details, please see “Account” on Page 19.

### Firmware Upgrade

In this page, you can upgrade the firmware of your network camera.

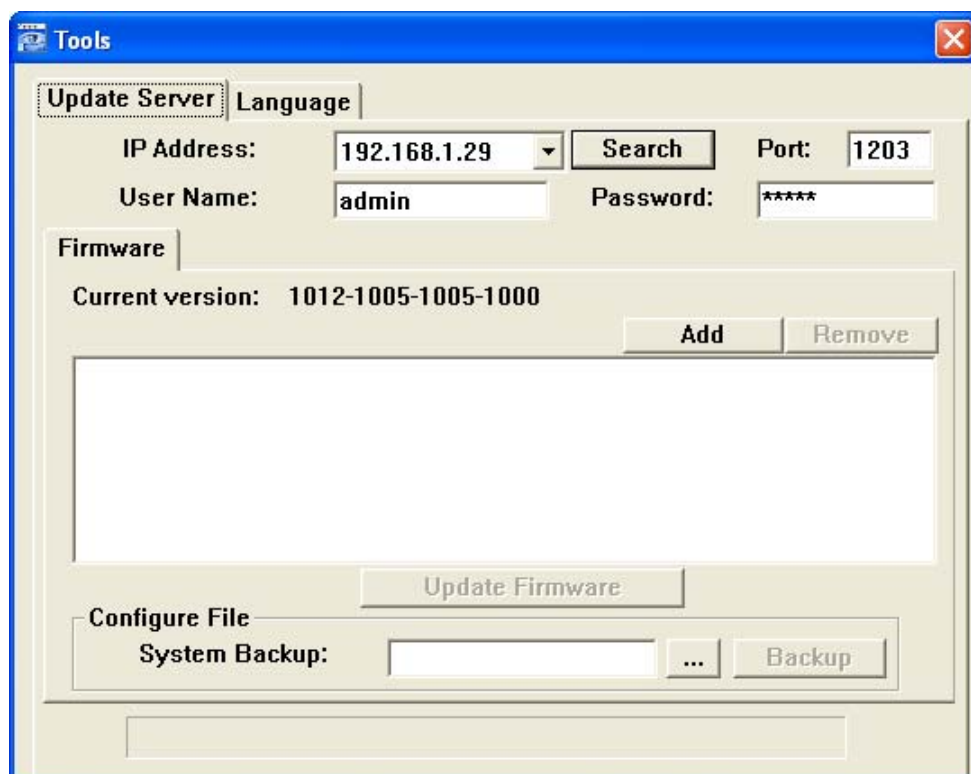

Function	Description
Update Server	Select the IP address of the network camera. Make sure the network settings of the selected network camera are correct.
Current Version	In the “Firmware” section, you will see the current firmware version. For example, 1010-1004-1003-1000
Add	To upgrade the firmware version of your network camera, click “Add” to locate and select the firmware files. There are several upgrade files. Please upgrade one by one.
Update Firmware	To start upgrading the firmware of the network camera, click “Update Firmware” to start the upgrade process. After upgraded, you will see a message shown on the screen: “Update Firmware Succeeded! Don’t plug off power, the machine will reboot automatically!”
System Backup (For DVR only)	If you want to backup your system before upgrading the firmware version, select “System Backup” in the “Configure File” section, click “...” to specify the location for saving system backup, and click “Backup” to start the backup process.

**Note:** The network setting of the camera might restore to default values after upgrade. If this is true, please set the network information again.

## Language Selection

This software is available in English / Chinese / French / German / Portuguese / Spanish / Japanese.

Select a language from the drop-down list, and press “Apply”. You will be prompted to restart the application to make this change take effect.

**Note:** The default language depends on the operation system of your PC. If the language of your operation system is not supported by this software, English will be the default language.

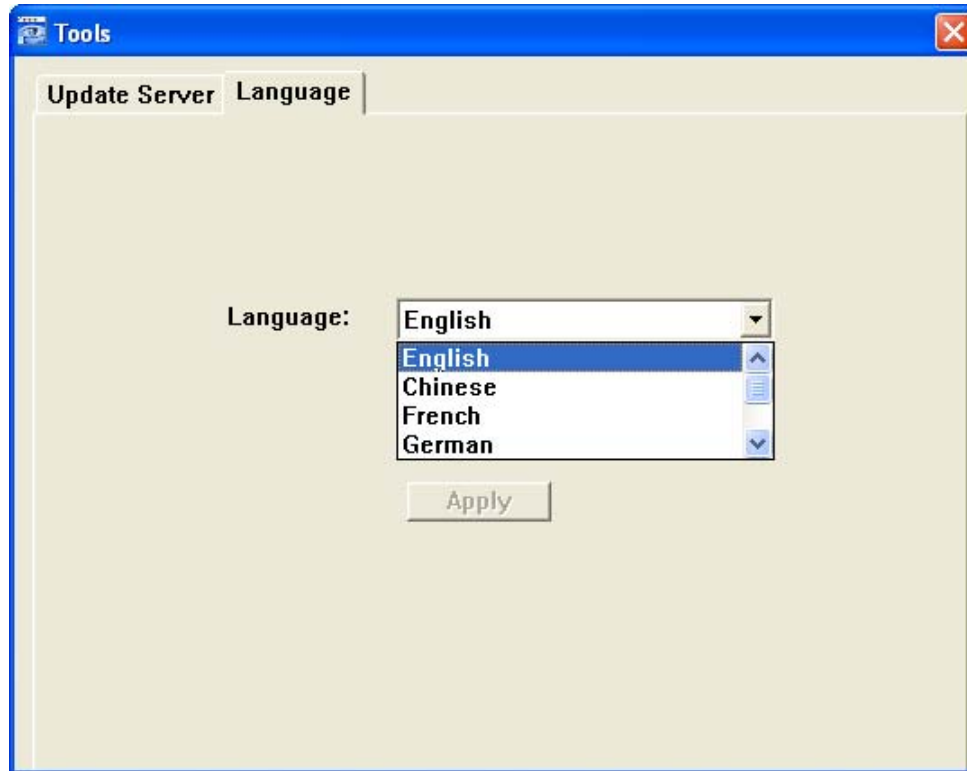

## 5.6 Status List

Click  to view all the event and record logs (All), or search for the specific log(s) by date or by record type (Condition).

There are three types of logs: Record, Backup and Event. To playback the recorded data for a specific record or backup log, select the log, and double-click to start the video playback.

For detailed playback operation, please refer to “Playback Screen” on Page 31.

### Record

Select “Record” to search for the specific log(s) by date or by record type.

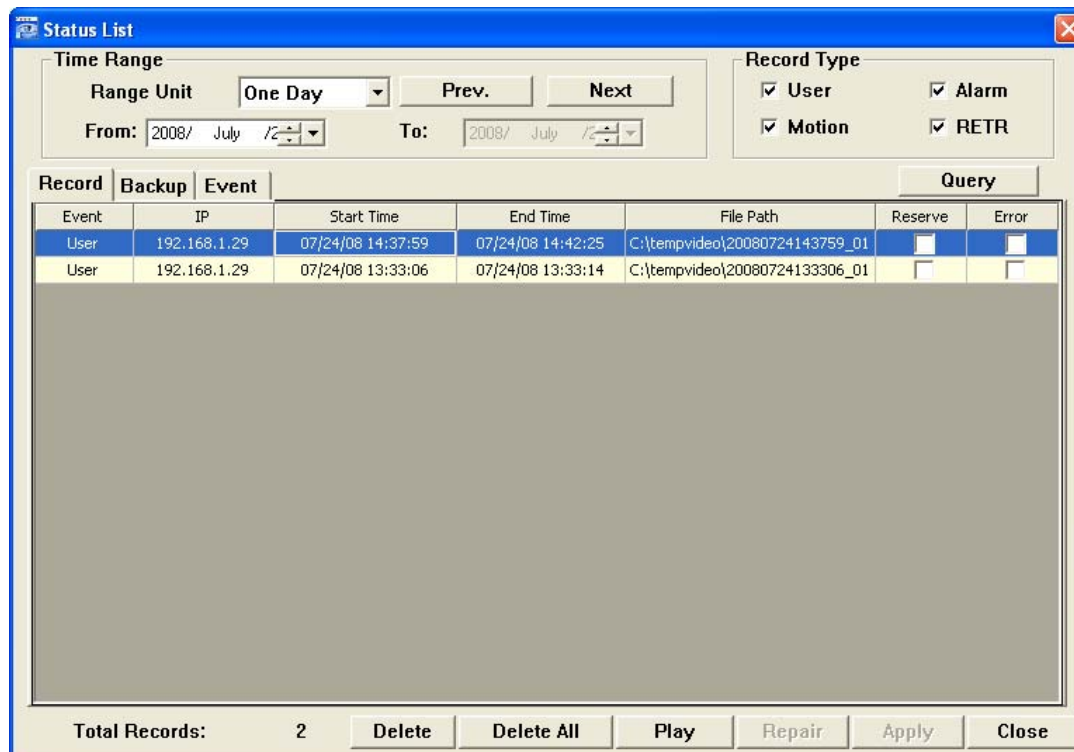



Button / Function	Description
Range Unit	Set different time range unit (One Day / One Week) of the event logs.
Date Selection (From / To)	Choose the specific date range including the event / record logs you might want.
Record Type	This section is enabled only when the "Record" tab is selected. Select the record type you want to search (User / Alarm / Motion).
Query	When all the search criteria are set, click to search the specified logs. The result will be displayed in the log list, arranged by time from the earliest to the latest.
Delete / Delete All	Click "Delete" to remove the selected log(s), or click "Delete All" to clear the current log list. <b>Tip: To select more logs all at once, press and hold the "Ctrl" key on your keyboard, and click to select the logs you want to remove.</b>
Play	Click to play the selected record log. The playback panel will be shown for your further operation. For playback details, please see "Playback Screen" on Page 31.
Repair	Click to fix the log with errors.
Apply	This button is available in the "Record" tab when the "Reserve" checkbox is checked or unchecked. If you want to keep an important record log for future reference and it can't be removed, check the "Reserve" checkbox, and click "Apply". The selected log will be kept and won't be deleted when somebody accidentally or intentionally chooses it and click "Delete" or "Delete All".
Close	Click "Close" to quit this window.

## Event

Select "Event" to search for the specific event log(s) by date.

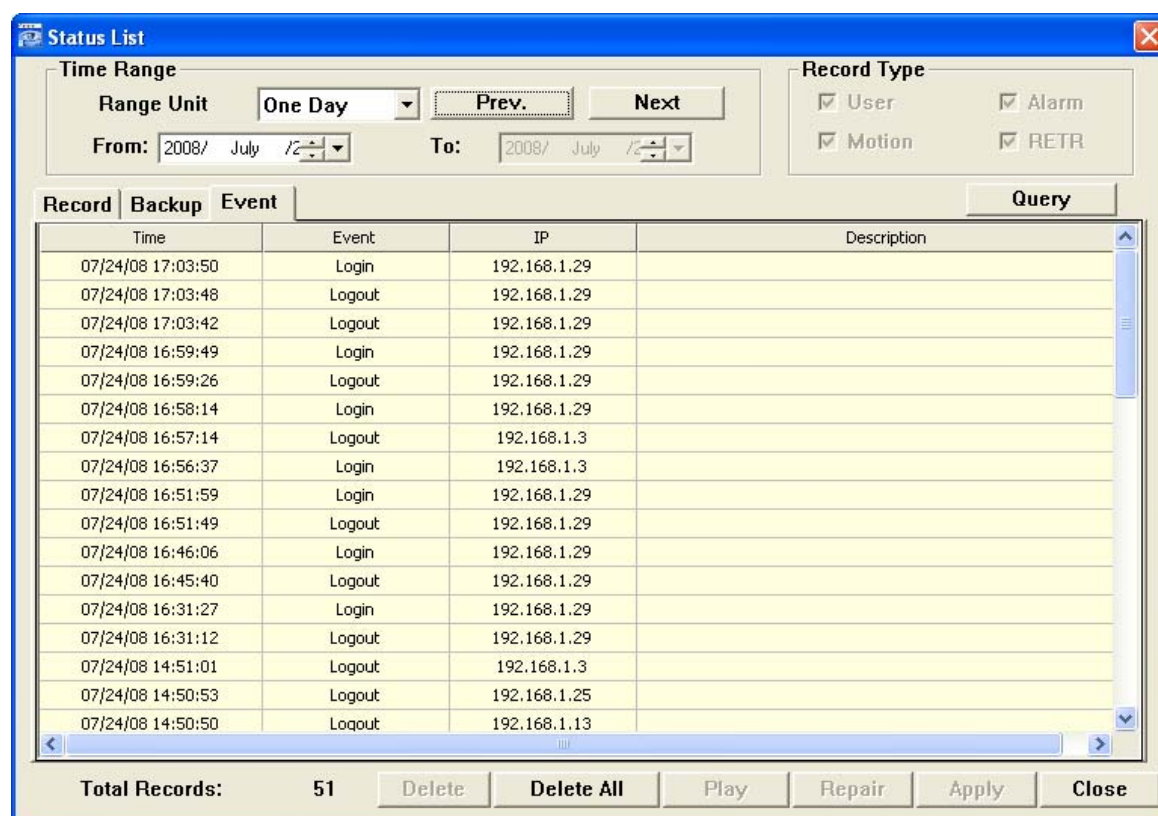

Button / Function	Description
Range Unit	Set different time range unit (One Day / One Week) of the event logs.
Date Selection (From / To)	Choose the specific date range including the event / record logs you might want.
Query	When all the search criteria are set, click to search the specified logs. The result will be displayed in the log list, arranged by time from the earliest to the latest.
Delete / Delete All	Click "Delete" to remove the selected log(s), or click "Delete All" to clear the current log list. <b>Tip: To select more logs all at once, press and hold the "Ctrl" key on your keyboard, and click to select the logs you want to remove.</b>
Close	Click "Close" to quit this window.

## Backup (For DVR only)

Select "Backup" to search for the specific log(s) by date.

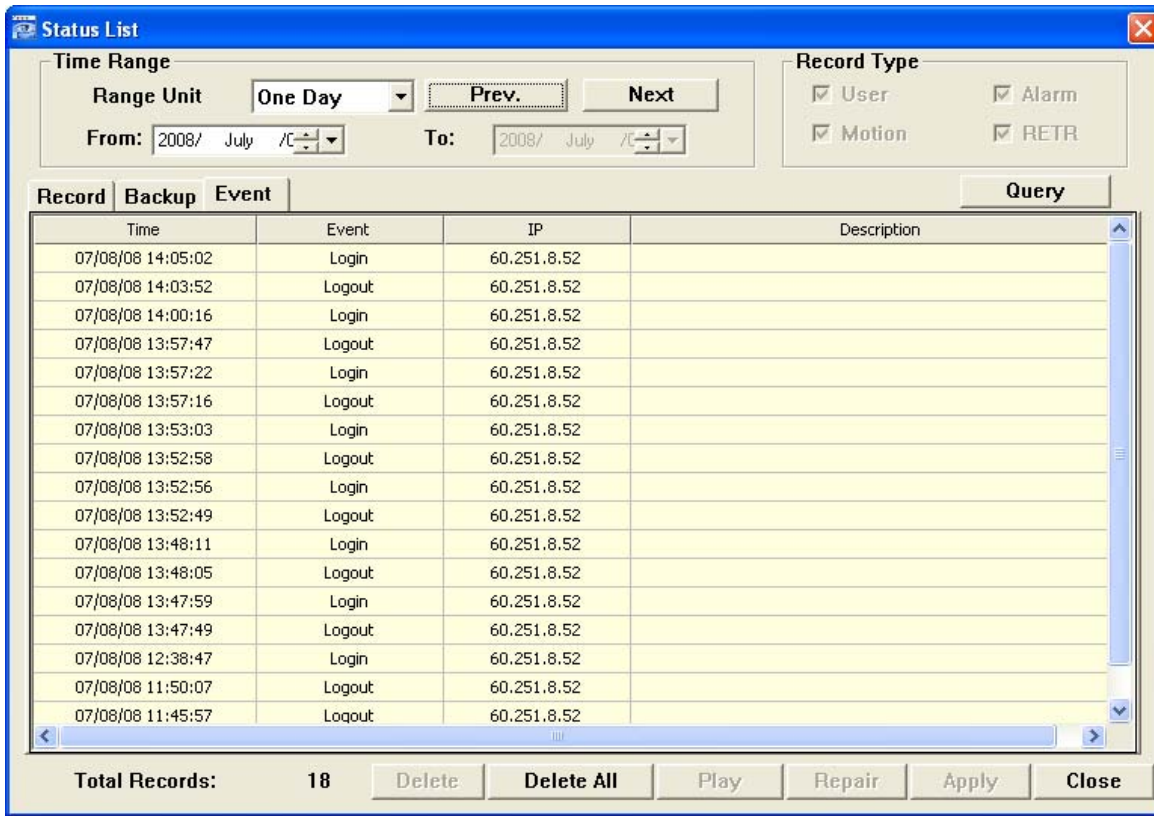

Button / Function	Description
Range Unit	Set different time range unit (One Day / One Week) of the event logs.
Date Selection (From / To)	Choose the specific date range including the event / record logs you might want.
Query	When all the search criteria are set, click to search the specified logs. The result will be displayed in the log list, arranged by time from the earliest to the latest.
Delete / Delete All	Click "Delete" to remove the selected log(s), or click "Delete All" to clear the current log list. <b>Tip: To select more logs all at once, press and hold the "Ctrl" key on your keyboard, and click to select the logs you want to remove.</b>
Play	Click to play the selected download log. The playback panel will be shown for your further operation. For playback details, please see "Playback Screen" on Page 31.
Close	Click "Close" to quit this window.

## Playback Screen

When you select and play the recorded data for a specific log, you will immediately go into the playback mode, and the following playback panel appears.

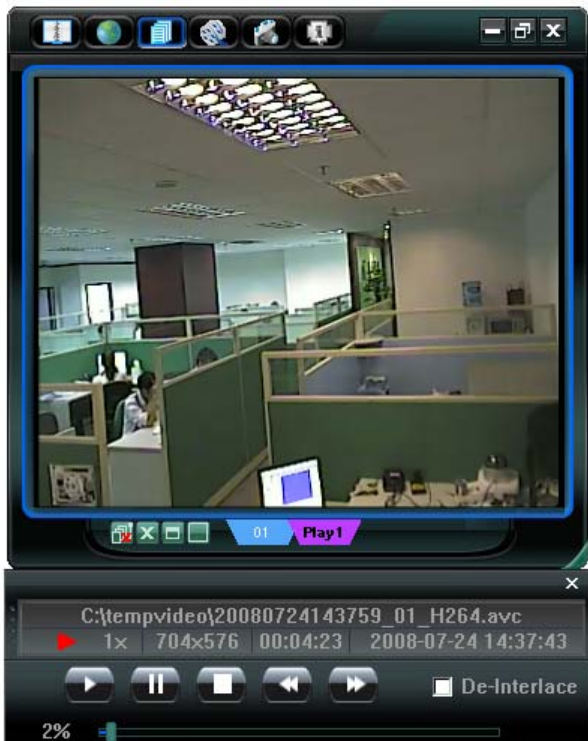

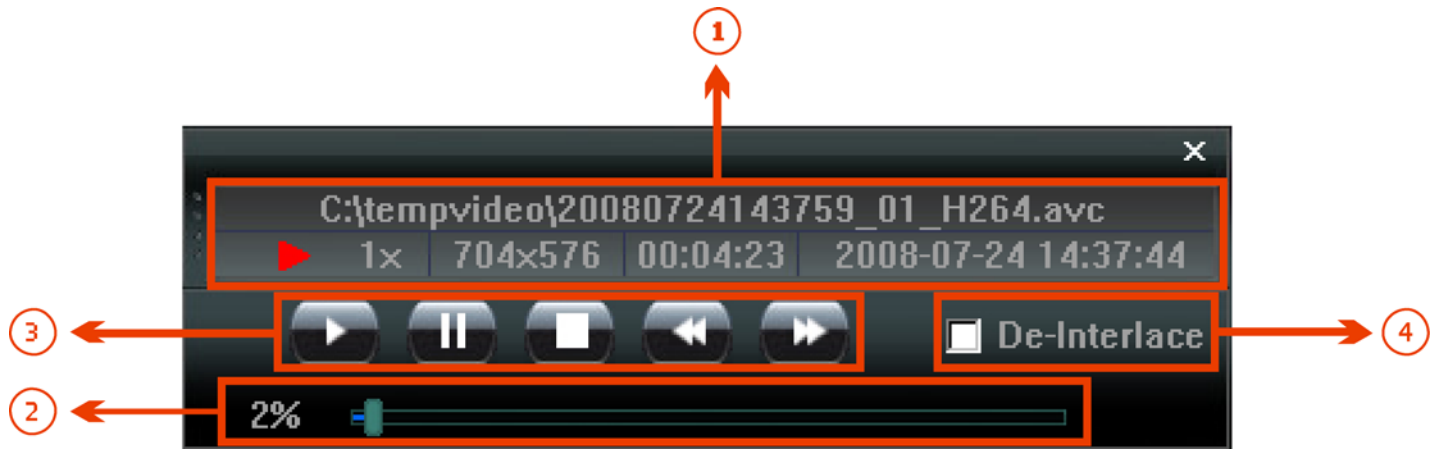

NO.	Function	Description
①	Playback / Download Info Display	This area shows the detailed playback / download information, such as the file name, record date and time, and the speed, etc.
②	Playback Progress Bar	This area shows the playback progress and the progress percentage.
③	Playback Operation	<p>This area is enabled only when the playback is started.</p> <p>⏮ (Rewind) / ⏭ (Forward) / ⏹ (Stop) / ⏸ (Pause) / ⏪ (Play)</p> <p><b>Rewind / Forward</b> Click once to get 2X fast rewind / forward, twice to get 4X, three times to get 8X, and four times to get 16X the highest.</p>
④	De-Interlace	Click to reduce the vibration of the paused picture.

## 6. IE WEB BROWSER

### 6.1 Access the Camera from an IE Web Browser

You can view the images or operate your network camera from an IE web browser.

**Note:** The supported PC operation systems are Windows 2000 and Windows XP.

Step 1: Key in the IP address used by your network camera in the URL address box, such as “http://ipcam.dyndns.org”, and press Enter. You will be prompted to enter the user name and password to access the network camera. If the port number your network camera used is NOT 80, you need to key in the port number additionally. **The format is “http://ipaddress:portnum”.**



Take dynamic IP type as an example: Host name “ipcam.dyndns.org” / Port number “202”. Key in “http://ipcam.dyndns.org:202” into the URL address box, and press “Enter”.

Step 2: Enter the user name and password, the same as the ones used at the Video Viewer, and press “OK”. You will see a similar screen as the following when the login information is correct.



### 6.2 Toolbar Display on the IE Web Browser

NO.	Function		Description
1	Main	ActiveX / Quick Time	According to the type of web browser on your operating system, choose the ActiveX or QuickTime controls.
		TCP / UDP	Choose the internet transmission protocol: TCP / UDP.
		BEST / HIGH / NORMAL / LOW	Choose the image quality: BEST / HIGH / NORMAL / LOW
		VGA / QVGA	Choose the image size: VGA (640 × 480) / QVGA (320 × 240).
		Audio On / Audio Off	Choose the audio function: On or Off. (This audio function is only for AVI202 and AVI212 model)
2	Network	Static IP / DHCP / PPPOE / DDNS	In the “Network” page, you can set the network configuration of the network camera. For details, please refer to “Network” section of the Video Viewer on Page 22.
		SNTP	Set the SNTP (Simple Network Time Protocol) for the time setting. For details, please refer to “錯誤! 表格製作不正確。” section of the Video Viewer on Page 26.
		FTP	Assigned a specific FTP site for the motion/alarm notification function. For details, please refer to “FTP” section of the Video Viewer on Page 26.
		MAIL	Assigned a specific email account for the motion/alarm notification function. For details, please refer to “MAIL” section of the Video Viewer on Page 27.

NO.	Function		Description
3	Camera	Snapshot Path	Set the location where the snapshot pictures are saved.
		Frame Rate	According to the bandwidth, set the required frame rate (FULL / HALF / ONE THIRD / QUARTER / ONE FIFTH / ONE TENTH / ONE FIFTEENTH). For details, please refer to "Video" section of the Video Viewer on Page 27.
		System Type	Set the system type of the connected network camera (NTSC / PAL).
		Stream Format	Select the stream format of the network transmission (MPEG-4 / Motion JPEG).
		Maximum Exposure Limits	To compensate for the lighting conditions, the maximum exposure time can be adjusted. For details, please refer to "Video" section of the Video Viewer on Page 27.
		Detection	Motion detection is used to generate a motion trigger whenever a movement occurs in the video image. Set the motion detection area. For details, please refer to "錯誤! 表格製作不正確。" section of the Video Viewer on Page 21.
		Motion Sensitivity Level	Set different motion sensitivity level according to different application. For details, please refer to "錯誤! 表格製作不正確。" section of the Video Viewer on Page 21.
		Color Setting	Adjust the brightness / contrast / hue / saturation for the network camera. For details, please refer to "5.1 Color Setting" section of the Video Viewer on Page 15.
5	General	Language	Support English / Chinese language for the web interface.
		Mac Address	Display the MAC address of the network camera. For details, please refer to "General" section of the Video Viewer on Page 18.
		Log	In the "Log" page, you can see all the logs for the network camera, such as "POWER ON", "REMOTE LOGIN", "RESET DEFAULT", "EMAIL", "FTP", "DDNS", "PPPOE", "DHCP" and "SNTP UPDATE"...etc. For details, please refer to "Log" section of the Video Viewer on Page 19.
		Account	Add / Edit / Delete the user name, password, user level and life time for accessing the network camera. For details, please refer to APPENDIX 2 USER LEVEL FOR REMOTE OPERATION" on Page 39.
		Trigger	Set the motion trigger and/or alarm trigger function, such as "Trigger Motion", "Trigger Alarm" and "Trigger Duration". Set the motion trigger and/or alarm trigger notification function, such as "Method" and "Record Time". For details, please refer to "錯誤! 表格製作不正確。" section of the Video Viewer on Page 21.
		Configure	Display and upgrade the firmware version of the network camera. For details, please refer to "5.5 Tools" section of the Video Viewer on Page 28.
6	Snapshot		Click this button to take a snapshot of the current view. The snapshot will be saved in the path you specified in the "Snapshot Path" of the "Camera" menu from the IE browser.
7	QVGA Resize		Click this button to enlarge the QVGA viewing size in the live view.

## 7. QUICKTIME PLAYER

You can also use the QuickTime player to log into the network camera and check the live view only.

**Note:** QuickTime is Apple's multimedia software. You need to have QuickTime installed in your computer first, and you can access the network camera to see the live view.

Step 1: Go to Apple's official website to download QuickTime. The website address is as follows:

<http://www.apple.com/quicktime/win.html>

- a). Click "Download" to go into the download page, and select to download the free player.
- b). Leave your Email address, and press "Free Download Now" to download the latest QuickTime player.
- c). When the download is completed, execute the "QuickTimeInstaller.exe" file, and follow the on-screen instructions to finish the installation procedure.

Step 2: Open your QuickTime player. Select "File" → "Open URL", and key in the URL address.

The URL format for MPEG4 IP cameras is "rtsp://ipaddress:port/live/mpeg4".

The URL format for H.264 IP cameras is "rtsp://ipaddress:port/live/h264".

For example, if the IP address is "avtechipcam.dyndns.org" and port number is "201", key in "rtsp://avtechipcam.dyndns.org:201/live/mpeg4" in the URL box. Click "OK" to continue.

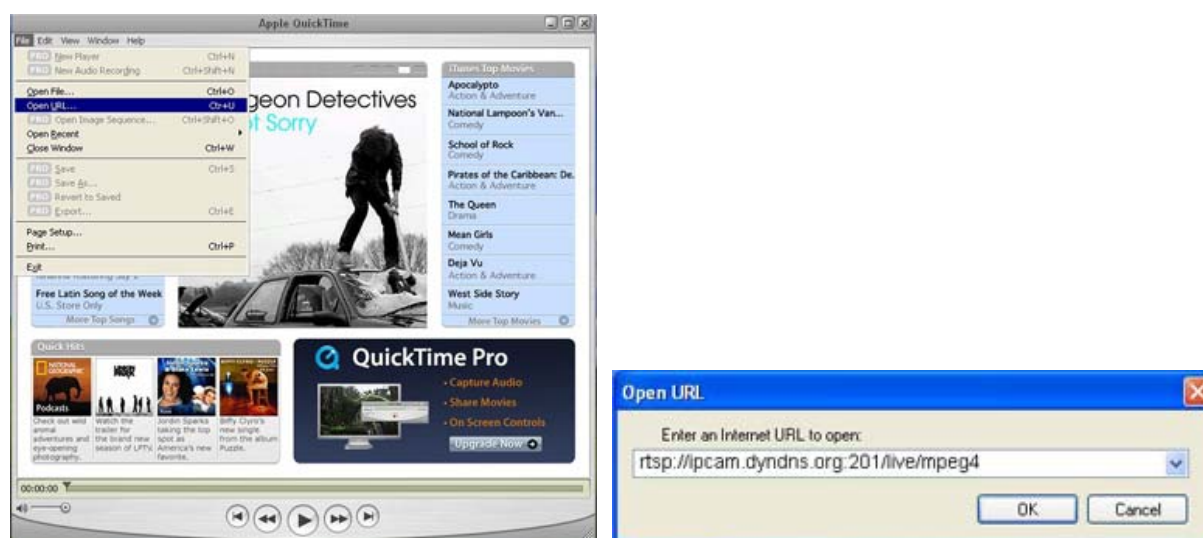

Step 3: A pop-up window will appear and prompt you to enter the authentication information. Key in the user name and password for accessing your network camera. The user name and password are the same as the ones you use to log into the Video Viewer.

If the information is correct, press "OK" to go on. If not, press "Cancel" to quit the accessing.



Step 4: When the login is successful, you will see a similar screen as the following.



## APPENDIX 1 RECORDING TIME TABLE

The following table lists the recording time table for AVI202 and AVI203 and takes PAL video system image capture as an example. The compression format for AVI202 is MPEG4, and the one for AVI203 is H.264.

• Table 1: static state

Resolution	Quality	AVI202		AVI203	
		Frame Rate	MB/Hrs	Frame Rate	MB/Hrs
VGA	Best	full	992	full	1044
		1/2	728	1/2	440
		1/3	552	1/3	304
		1/4	458	1/4	240
		1/5	442	1/5	198.6
		1/10	232	1/10	113.7
		1/15	153.2	--	--
	High	full	826	full	396
		1/2	490	1/2	193.4
		1/3	364	1/3	139.8
		1/4	330	1/4	124.2
		1/5	296	1/5	95.8
		1/10	163.2	1/10	64.5
		1/15	128.8	--	--
	Normal	full	490	full	208
		1/2	278	1/2	109.4
		1/3	226	1/3	85.2
		1/4	196.6	1/4	75.2
		1/5	180.6	1/5	64.6
		1/10	100.8	1/10	45.9
		1/15	79.4	--	--
Basic	full	276	full	104	
	1/2	185.4	1/2	62.8	
	1/3	147.6	1/3	51.2	
	1/4	131.8	1/4	50.2	
	1/5	125.2	1/5	44.2	
	1/10	68.2	1/10	36	
	1/15	56.8	--	--	
QVGA	Best	full	778	full	136.8
		1/2	464	1/2	84.2
		1/3	352	1/3	65.2
		1/4	292	1/4	63
		1/5	262	1/5	52.8
		1/10	134.4	1/10	41.1
		1/15	78.4	--	--
	High	full	522	full	86.8
		1/2	290	1/2	58
		1/3	218	1/3	48.2
		1/4	187	1/4	45.8
		1/5	170.2	1/5	41.6
		1/10	91.4	1/10	35.1
		1/15	66.6	--	--
	Normal	full	288	full	64.2
		1/2	172	1/2	47.8
		1/3	140.6	1/3	41.6
		1/4	124	1/4	39
		1/5	111.6	1/5	37.4
		1/10	63	1/10	33
		1/15	55.4	--	--
Basic	full	166	full	52	
	1/2	112	1/2	40.8	
	1/3	91.8	1/3	37.2	
	1/4	80.6	1/4	35	
	1/5	83.6	1/5	34.4	
	1/10	49.4	1/10	31.8	
	1/15	36.2	--	--	

• Table 2: dynamic state

Resolution	Quality	AVI202		AVI203	
		Frame Rate	MB/Hrs	Frame Rate	MB/Hrs
4CIF	Best	full	978	full	1743
		1/2	843	1/2	660
		1/3	582	1/3	414
		1/4	453	1/4	339
		1/5	384	1/5	259.5
		1/10	257.1	1/10	135
		1/15	174.3	--	--
	High	full	951	full	1158
		1/2	552	1/2	615
		1/3	399	1/3	435
		1/4	315	1/4	357
		1/5	274.5	1/5	282
		1/10	194.1	1/10	159.3
		1/15	148.8	--	--
	Normal	full	606	full	870
		1/2	354	1/2	534
		1/3	286.8	1/3	378
		1/4	217.8	1/4	303
		1/5	201	1/5	261.3
		1/10	157.8	1/10	136.2
		1/15	126.9	--	--
	Basic	full	552	full	705
		1/2	330	1/2	384
		1/3	248.4	1/3	285
		1/4	200.1	1/4	207.6
		1/5	177	1/5	194.7
		1/10	129	1/10	104.1
		1/15	104.4	--	--
CIF	Best	full	909	full	588
		1/2	543	1/2	363
		1/3	378	1/3	260.4
		1/4	278.4	1/4	367.6
		1/5	255.3	1/5	182.4
		1/10	166.8	1/10	105
		1/15	121.8	--	--
	High	full	543	full	522
		1/2	290.4	1/2	275.4
		1/3	208.2	1/3	209.4
		1/4	167.4	1/4	166.5
		1/5	146.4	1/5	151.8
		1/10	105	1/10	87.3
		1/15	80.4	--	--
	Normal	full	348	full	366
		1/2	181.5	1/2	231
		1/3	136.8	1/3	156.6
		1/4	114.3	1/4	138.6
		1/5	102.3	1/5	120.6
		1/10	81	1/10	73.8
		1/15	67.2	--	--
	Basic	full	202	full	250
		1/2	143.4	1/2	166.5
		1/3	110.7	1/3	127.8
		1/4	93.6	1/4	105
		1/5	82.5	1/5	95.4
		1/10	66.9	1/10	59.1
		1/15	62.4	--	--



- **Table 3: Suggested Settings**

**Note:** It is recommended to take the following settings for Frame Rate / Resolution / Quality when you use AVI203 under the upload speed of 2M / 1M / 512Kbps.

Upload Speed	<i>H.264</i>			<i>MPEG4</i>			<i>MJPEG</i>		
	Resolution	Quality	Frame Rate	Resolution	Quality	Frame Rate	Resolution	Quality	Frame Rate
2M	4CIF	Normal	full	4CIF	Normal	1/3	4CIF	Normal	1/4
1M	4CIF	Normal	1/3	4CIF	Normal	1/5	4CIF	Normal	1/5
512Kbps	4CIF	Normal	1/4	CIF	High	1/5	CIF	Normal	1/4

## APPENDIX 2 USER LEVEL FOR REMOTE OPERATION

### ● For Video Viewer (AVI201 / 202 / 203 / 212)

	Supervisor	Power User	Normal User	Guest
<b>Address Book</b>	●	●	●	●
<b>Emap</b>	●	●	●	●
<b>Miscellaneous Control</b>				
Color Setting	●	X	X	X
Backup	X	X	X	X
Record Setting	●	●	●	●
Server Setting	●	X	X	X
<b>Tools</b>				
* Update	●	X	X	X
* Language	●	●	●	●
Status List	●	●	●	●
<b>Record</b>	●	●	●	●
<b>Snapshot</b>	●	●	●	●
<b>Information</b>	●	●	●	●

### ● For Web Browser (AVI201)

	Supervisor	Power User	Normal User	Guest
<b>Main</b>				
Connection Mode	●	●	●	●
Protocol	●	●	●	●
Quality	●	●	●	X
Change resolution	●	●	●	X
<b>Network</b>				
DDNS	●	●	X	X
SNTP	●	X	X	X
FTP	●	●	X	X
MAIL	●	●	X	X
<b>Camera</b>				
Color	●	●	X	X
<b>General</b>				
Log	●	X	X	X
Account	●	X	X	X
Trigger	●	●	X	X
Configure	●	X	X	X
<b>Snapshot</b>	●	●	●	●

## ● For Web Browser (AVI202)

	Supervisor	Power User	Normal User	Guest
<b>Main</b>				
Connection Mode	●	●	●	●
Protocol	●	●	●	●
Quality	●	●	●	X
Change resolution	●	●	●	X
Audio function	●	●	●	X
<b>Network</b>				
DDNS	●	●	X	X
SNTP	●	X	X	X
FTP	●	●	X	X
MAIL	●	●	X	X
<b>Camera</b>				
Color	●	●	X	X
<b>General</b>				
Log	●	X	X	X
Account	●	X	X	X
Trigger	●	●	X	X
Configure	●	X	X	X
<b>Snapshot</b>	●	●	●	●

## ● For Web Browser (AVI203)

	Supervisor	Power User	Normal User	Guest
<b>Main</b>				
Stream format	●	●	●	●
Quality	●	●	●	X
Change resolution	●	●	●	X
Audio function	●	●	●	X
<b>Network</b>				
DDNS	●	X	X	X
SNTP	●	X	X	X
FTP	●	X	X	X
MAIL	●	X	X	X
Filter	●	X	X	X
UPnP	●	X	X	X
<b>Camera</b>				
Color	●	X	X	X
Time	●	X	X	X
<b>General</b>				
Log	●	X	X	X
Account	●	X	X	X
Trigger	●	X	X	X
Video	●	X	X	X
Configure	●	X	X	X
<b>Snapshot</b>	●	●	●	●

**APPENDIX 3 DEFAULT VALUE**• **Default Value**

Items	Default Value
• <b>Default Network Settings:</b>	
User Name	admin
Password	admin
Port	80
IP Address	192.168.1.10